

MITSUBISHI IGBT MODULES
MG600Q1US59A

HIGH POWER SWITCHING APPLICATIONS
 MOTOR CONTROL APPLICATIONS

MG600Q1US59A



FEATURE

- The electrodes are isolated from case.
- Enhancement-mode
- Integrates fault-signal output circuit in package. (Short-Circuit and Over-Current)
- UL Recognized Yellow Card No.E80276
File No.E80271

APPLICATION

General purpose inverters, servo drives and motor controls

OUTLINE DRAWING & EQUIVALENT CIRCUIT

Dimensions in mm

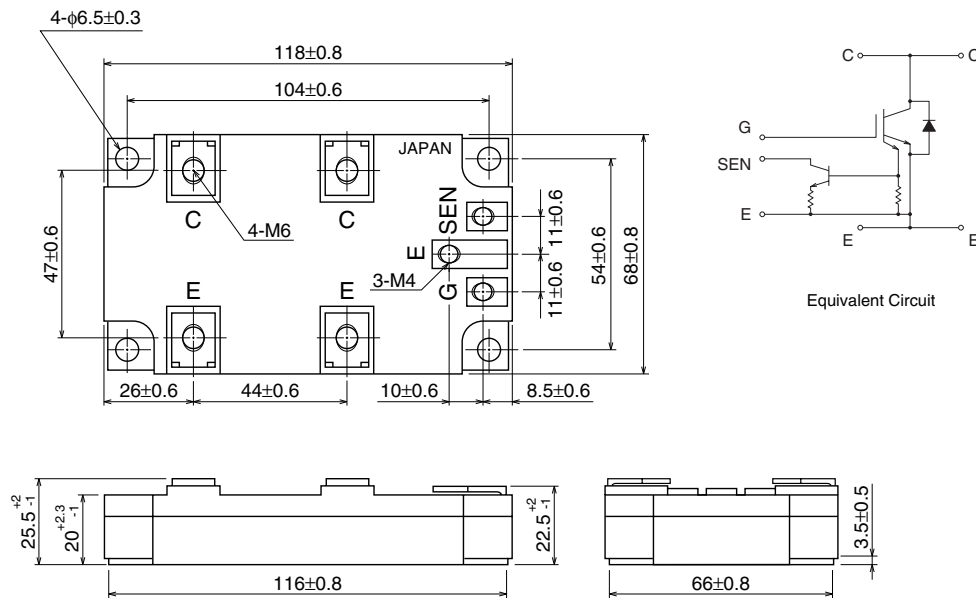

Weight: 420g

MG600Q1US59A

HIGH POWER SWITCHING APPLICATIONS
MOTOR CONTROL APPLICATIONS

MAXIMUM RATINGS (Ta = 25°C)

Symbol	Parameter		Conditions	Ratings	Unit
VCES	Collector-emitter voltage			1200	V
VGES	Gate-emitter voltage			±20	V
VSES	Sense-emitter voltage			40	V
IC	Collector current	DC		600	A
ICP		1ms		1200	
IF	Forward current	DC		600	A
IFM		1ms		1200	
PC	Collector power dissipation		Tc = 25°C	2750	W
Tj	Junction temperature			150	°C
Tstg	Storage temperature range			-40 ~ 125	°C
Vsol	Isolation voltage			2500 (AC 1 minute)	V
—	Screw torque	Terminal (M4/M6)		2/3	N • m
—		Mounting		3	

ELECTRICAL CHARACTERISTICS (Ta = 25°C)

Symbol	Parameter	Test conditions	Limits			Unit	
			Min.	Typ.	Max.		
IGES	Gate leakage current	VGE = ±20V, VCE = 0	—	—	±500	nA	
ICES	Collector cut-off current	VCE = 1200V, VGE = 0	—	—	1.0	mA	
VGE(off)	Gate-emitter cut-off voltage	IC = 600mA, VCE = 5V	4.0	—	7.0	V	
VCE(sat)	Collector-emitter saturation voltage	IC = 600A, Tj = 25°C	—	2.5	3.5	V	
Cies	Input capacitance	VCE = 10V, VGE = 0, f = 1MHz	—	100000	—	pF	
td(on)	Switching time	Turn-on delay time	—	0.2	—	µs	
tr		Rise time	Inductive load	—	0.1		—
ton		Turn-on time	VCC = 600V	—	0.3		—
td(off)		Turn-off delay time	IC = 600A	—	1.15		—
tf		Fall time	VGE = ±15V	—	0.15		0.3
toff		Turn-off time	RG = 2Ω (Note 1)	—	1.3		—
VF	Forward voltage	IF = 600A, VGE = 0	—	2.3	3.2	V	
trr	Reverse recovery time	IF = 600A, VGE = -15V, di/dt = 300A/µs (Note 1)	—	—	0.5	µs	
ISES	Sense leakage current	VSEN - E = 40V, VCE = 0, VGE = 0	—	—	200	nA	
IC(SEN-START)	Sense	Sense start current	VGE = 15V, VSE = 14.8V (Note 2)	1050	—	A	
VSEN		Sense voltage	VGE = 15V, IC = 2400A (Note 2)	—	—	13.2	V
Rth(j-c)	Thermal resistance	Transistor stage	—	—	0.045	°C/W	
		Diode stage	—	—	0.125		

MG600Q1US59A

HIGH POWER SWITCHING APPLICATIONS
MOTOR CONTROL APPLICATIONS

Note 1: Switching time and reverse recovery time test circuit and timing chart

Switching time test circuit

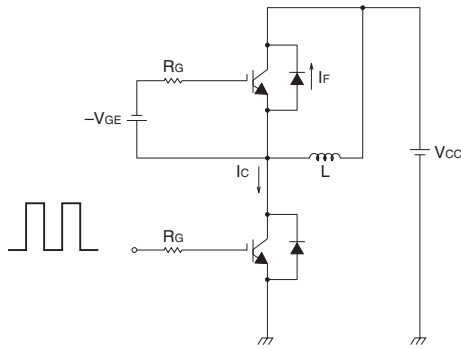

Timing chart

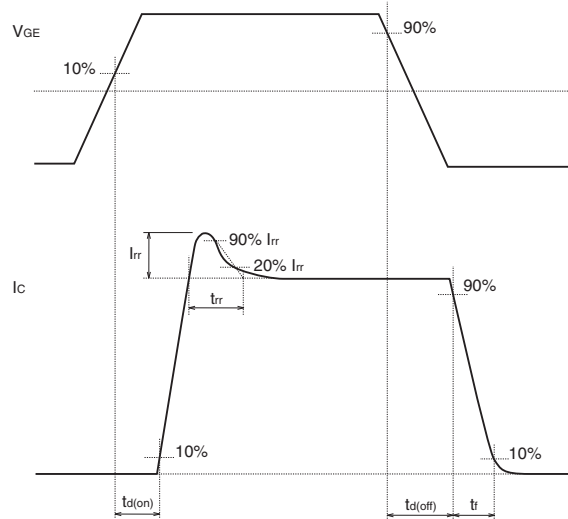

Note 2: Sense start current and sense voltage test circuit

Test circuit

*Measurement in the complete charge period.

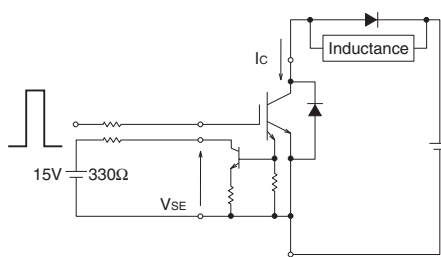

Timing chart

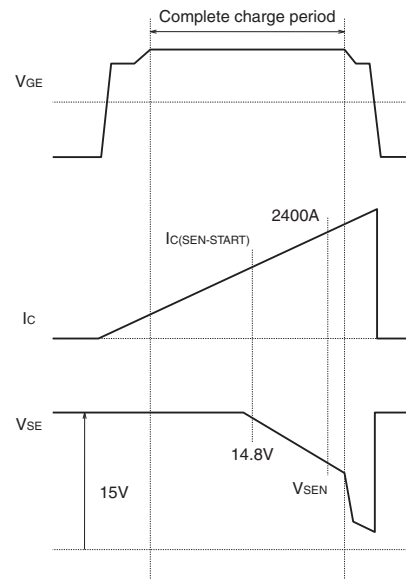

MG600Q1US59A

HIGH POWER SWITCHING APPLICATIONS
MOTOR CONTROL APPLICATIONS

<VCE(sat) Rank>

VCE(sat)

Rank symbol	MIN.	MAX.
22	1.9	2.2
23	2.0	2.3
24	2.1	2.4
25	2.2	2.5
26	2.3	2.6
27	2.4	2.7
28	2.5	2.8
29	2.6	2.9
30	2.7	3.0
31	2.8	3.1
32	2.9	3.2
33	3.0	3.3
34	3.1	3.4

<VF Rank>

VF

Rank symbol	MIN.	MAX.
B	1.5	1.8
C	1.7	2.0
D	1.9	2.2
E	2.1	2.4
F	2.3	2.6
G	2.5	2.8
H	2.7	3.0
I	2.9	3.2

<Mark position>

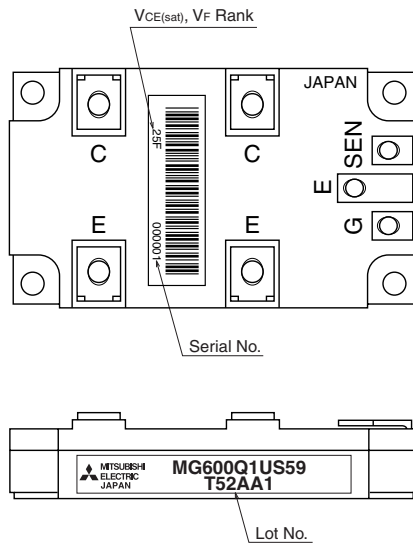

MG600Q1US59A

HIGH POWER SWITCHING APPLICATIONS
MOTOR CONTROL APPLICATIONS

PERFORMANCE CURVES

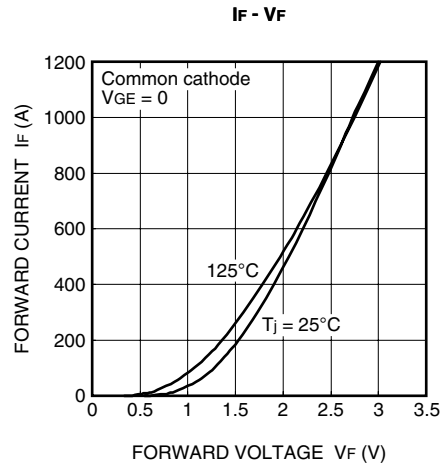
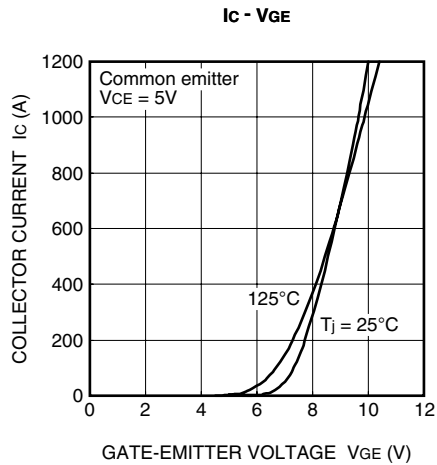
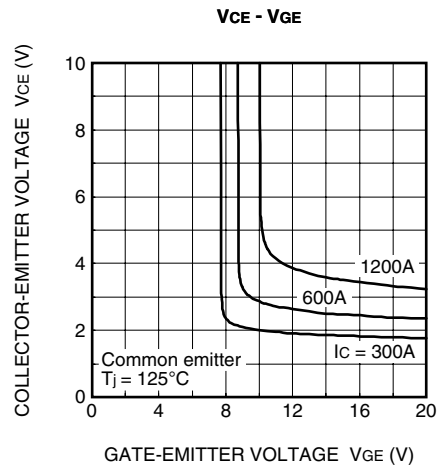
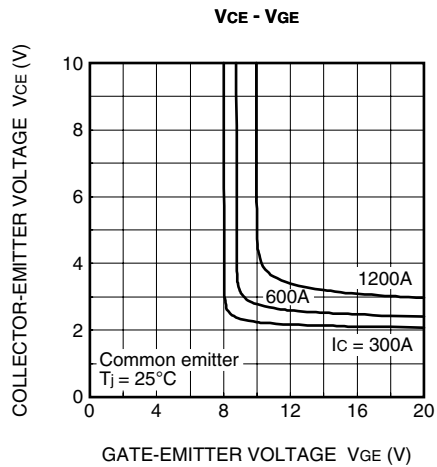
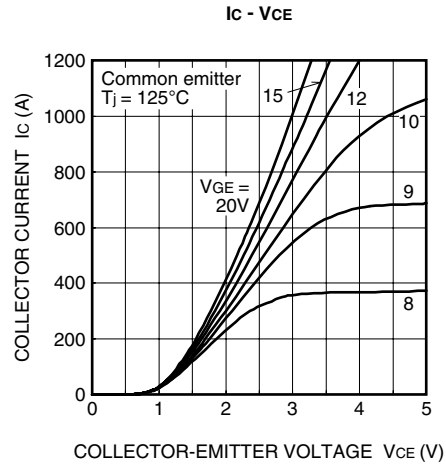
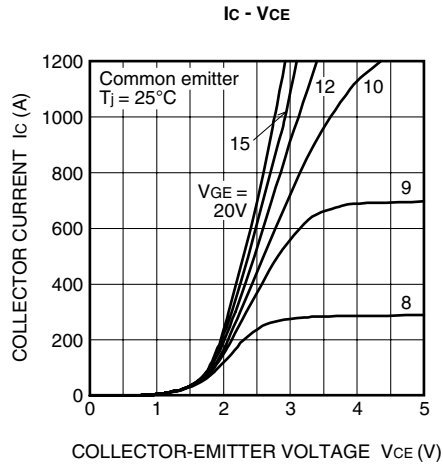

MG600Q1US59A

HIGH POWER SWITCHING APPLICATIONS
MOTOR CONTROL APPLICATIONS

SW time - R_G

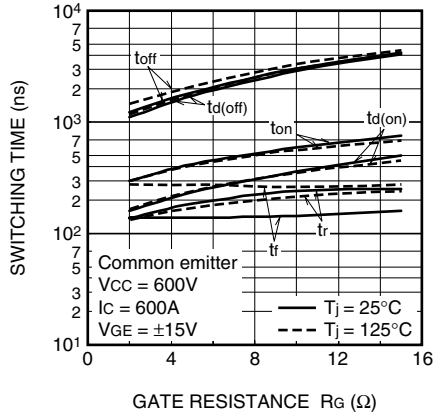

SW time - I_C

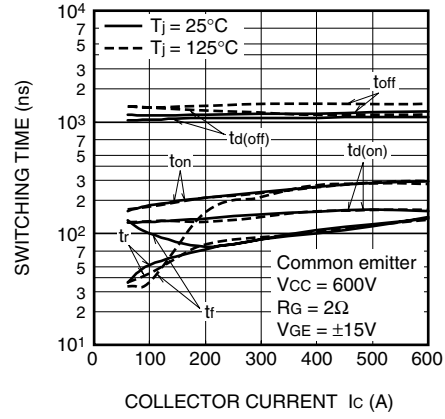

SW loss - R_G

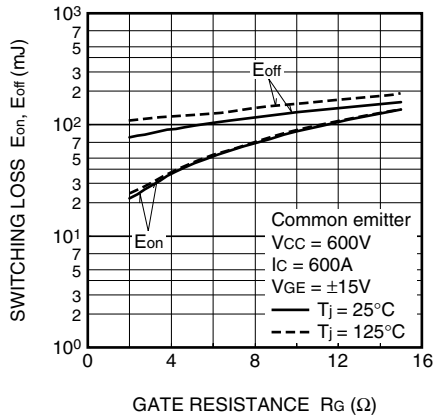

SW loss - I_C

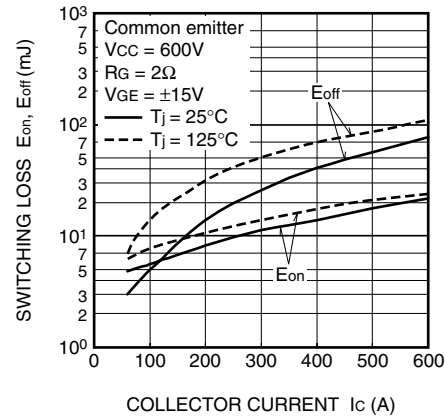

I_{rr}, t_{rr} - R_G

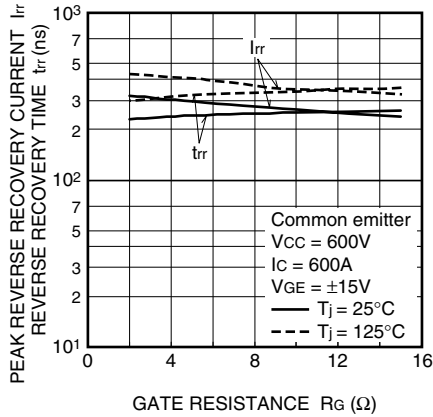

I_{rr}, t_{rr} - I_F

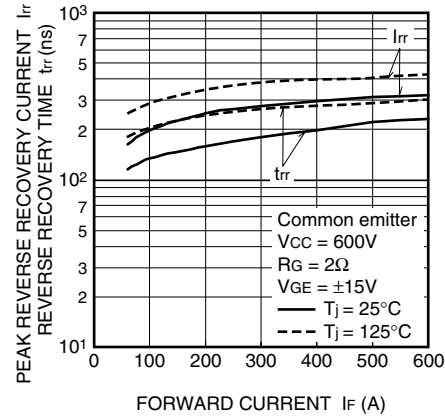

MG600Q1US59A

HIGH POWER SWITCHING APPLICATIONS
MOTOR CONTROL APPLICATIONS

