

DM54LS273/DM74LS273 8-Bit Register with Clear

General Description

The [®]LS273 is a high speed 8-bit register, consisting of eight D-type flip-flops with a common Clock and an asynchronous active LOW Master Reset. This device is supplied in a 20-pin package featuring 0.3 inch row spacing.

Features

- Edge-triggered
- 8-bit high speed register
- Parallel in and out
- Common clock and master reset

Connection Diagram

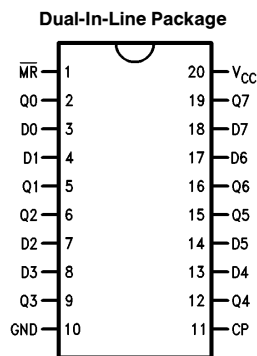

TL/F/9825-1

**Order Number DM54LS273E, DM54LS273J,
DM54LS273W, DM74LS273M or DM74LS273N
See NS Package Number E20A, J20A, M20B,
N20A or W20A**

Pin Names	Description
CP	Clock Pulse Input (Active Rising Edge)
D0–D7	Data Inputs
$\overline{\text{MR}}$	Asynchronous Master Reset Input (Active LOW)
Q0–Q7	Flip-Flop Outputs

Absolute Maximum Ratings (Note)

If Military/Aerospace specified devices are required, please contact the National Semiconductor Sales Office/Distributors for availability and specifications.

Supply Voltage	7V
Input Voltage	7V
Operating Free Air Temperature Range	
DM54LS	-55°C to +125°C
DM74LS	0°C to +70°C
Storage Temperature Range	-65°C to +150°C

Note: The "Absolute Maximum Ratings" are those values beyond which the safety of the device cannot be guaranteed. The device should not be operated at these limits. The parametric values defined in the "Electrical Characteristics" table are not guaranteed at the absolute maximum ratings. The "Recommended Operating Conditions" table will define the conditions for actual device operation.

Recommended Operating Conditions

Symbol	Parameter	DM54LS273			DM74LS273			Units
		Min	Nom	Max	Min	Nom	Max	
V _{CC}	Supply Voltage	4.5	5	5.5	4.75	5	5.25	V
V _{IH}	High Level Input Voltage	2			2			V
V _{IL}	Low Level Input Voltage			0.7			0.8	V
I _{OH}	High Level Output Current			-0.4			-0.4	mA
I _{OL}	Low Level Output Current			4			8	mA
T _A	Free Air Operating Temperature	-55		125	0		70	°C
t _s (H) t _s (L)	Setup Time HIGH or LOW D _n to CP	15			15			ns
t _h (H) t _h (L)	Hold Time HIGH or LOW D _n to CP	5			5			ns
t _w (H) t _w (L)	CP Pulse Width HIGH or LOW	20			20			ns
t _w (L)	M _{FR} Pulse Width LOW	20			20			ns
t _{rec}	Recovery Time M _{FR} to CP	15			15			ns

Electrical Characteristics

Over recommended operating free air temperature range (unless otherwise noted)

Symbol	Parameter	Conditions	Min	Typ (Note 1)	Max	Units
V _I	Input Clamp Voltage	V _{CC} = Min, I _I = -18 mA			-1.5	V
V _{OH}	High Level Output Voltage	V _{CC} = Min, I _{OH} = Max, V _{IL} = Max	DM54 2.5			V
			DM74 2.7	3.4		
V _{OL}	Low Level Output Voltage	V _{CC} = Min, I _{OL} = Max, V _{IH} = Min	DM54		0.4	V
			DM74	0.35	0.5	
		I _{OL} = 4 mA, V _{CC} = Min	DM74	0.25	0.4	
I _I	Input Current @ Max Input Voltage	V _{CC} = Max, V _I = 7V V _I = 10V (DM54)			0.1	mA
I _{IH}	High Level Input Current	V _{CC} = Max, V _I = 2.7V			20	μA
I _{IL}	Low Level Input Current	V _{CC} = Max, V _I = 0.4V			-0.4	mA
I _{OS}	Short Circuit Output Current	V _{CC} = Max (Note 2)	DM54 -20		-100	mA
			DM74 -20		-100	
I _{CC}	Supply Current	V _{CC} = Max			27	mA

Note 1: All typicals are at V_{CC} = 5V, T_A = 25°C.

Note 2: Not more than one output should be shorted at a time, and the duration should not exceed one second.



Switching Characteristics $V_{CC} = +5.0V, T_A = +25^\circ C$

Symbol	Parameter	$C_L = 15 \text{ pF}$				Units
		DM54LS		DM74LS		
		Min	Max	Min	Max	
f_{max}	Maximum Clock Frequency	30		30		MHz
t_{PLH} t_{PHL}	Propagation Delay CP to Q_n		24		24	ns
t_{PLH}	Propagation Delay \overline{MR} to Q_n		27		27	ns

Functional Description

The LS273 is an 8-bit parallel register with a common Clock and common Master Reset. When the \overline{MR} input is LOW, the Q outputs are LOW, independent of the other inputs. Information meeting the setup and hold time requirements of the D inputs is transferred to the Q outputs on the LOW-to-HIGH transition of the clock input.

Truth Table

MR	Inputs		Outputs Q_n
	CP	D_n	
L	X	X	L
H		H	H
H		L	L

H = HIGH Voltage Level
L = LOW Voltage Level
X = Immaterial

Logic Symbol

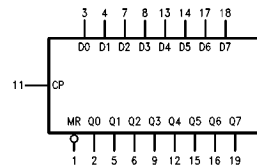

TL/F/9825-2

$V_{CC} = \text{Pin } 20$
 $GND = \text{Pin } 10$

Logic Diagram

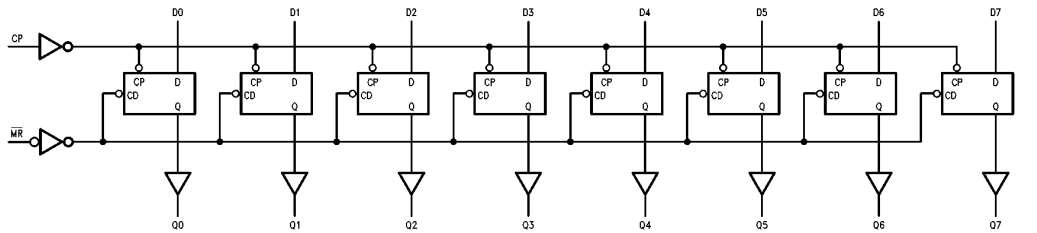

TL/F/9825-3

Physical Dimensions inches (millimeters)

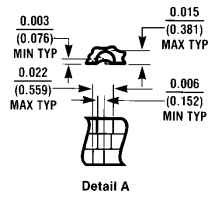
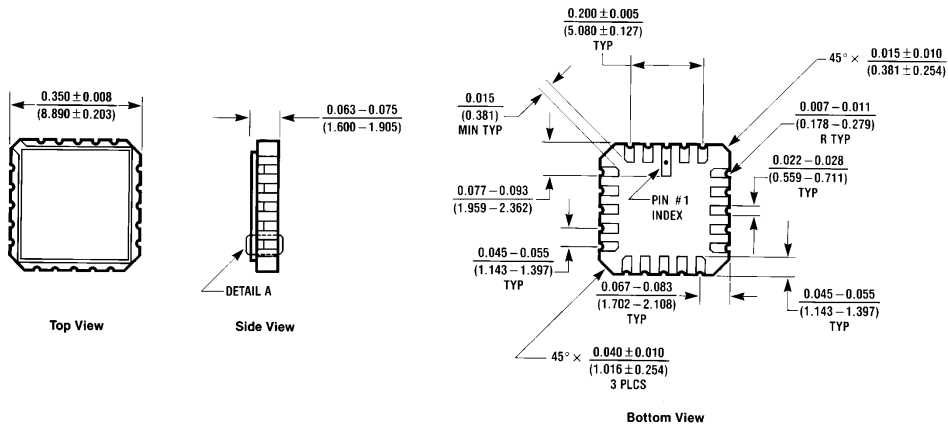

Ceramic Leadless Chip Carrier Package (E)
 Order Number DM54LS273E
 NS Package Number E20A

E20A (REV D)

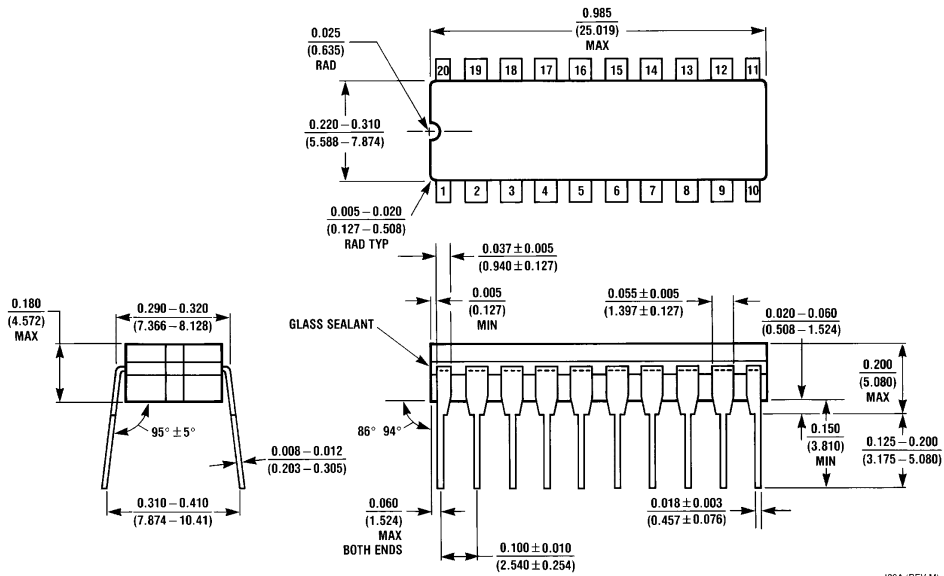

20-Lead Ceramic Dual-In-Line Package (J)
 Order Number DM54LS273J
 NS Package Number J20A

J20A (REV M)

Physical Dimensions inches (millimeters) (Continued)

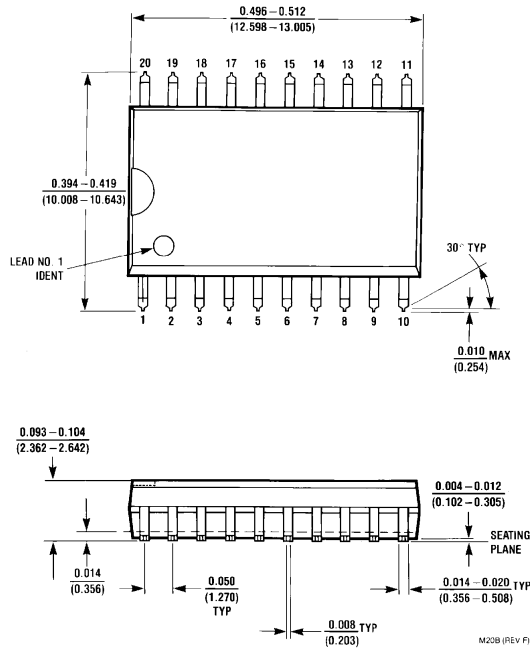

20-Lead Wide Small Outline Molded Package (M)
Order Number DM74LS273M
NS Package Number M20B

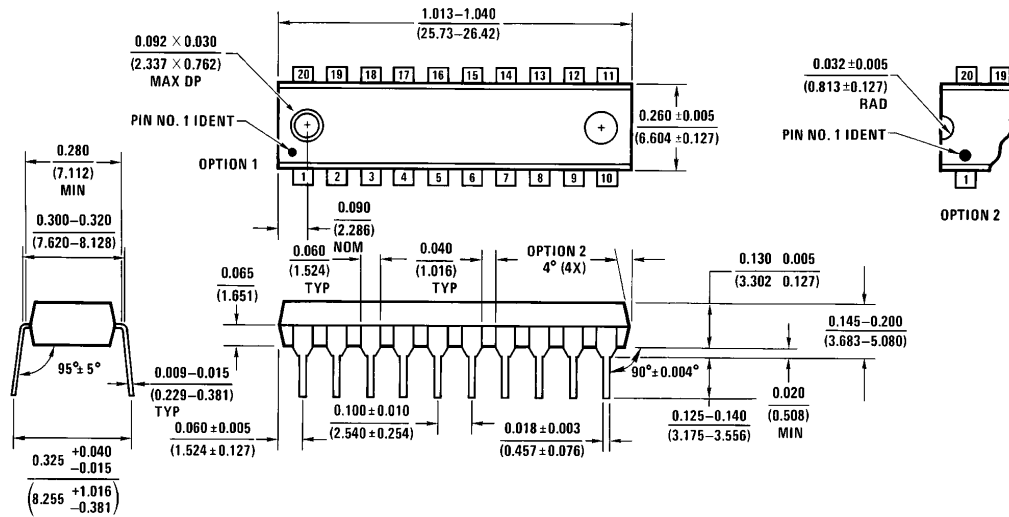

20-Lead Molded Dual-In-Line Package (N)
Order Number DM74LS273N
NS Package Number N20A

Physical Dimensions inches (millimeters) (Continued)

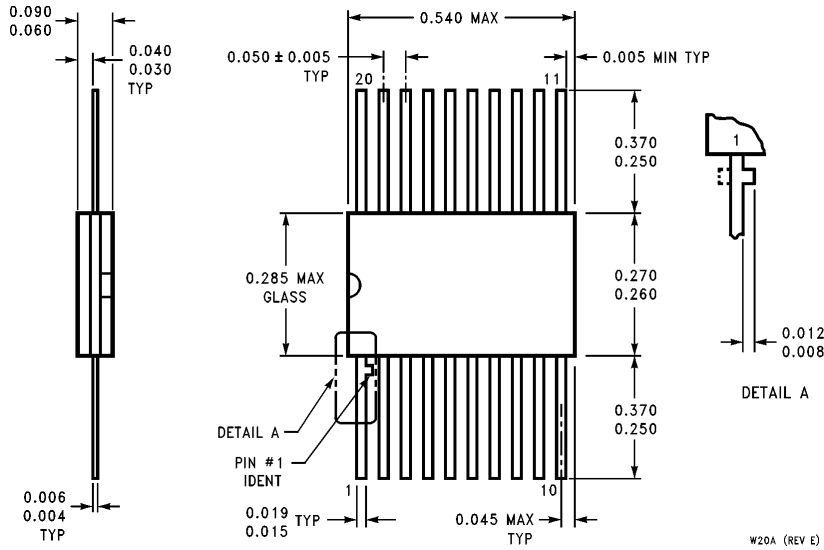

20-Lead Ceramic Flat Package (W)
Order Number DM54LS273W
NS Package Number W20A

W20A (REV E)

LIFE SUPPORT POLICY

NATIONAL'S PRODUCTS ARE NOT AUTHORIZED FOR USE AS CRITICAL COMPONENTS IN LIFE SUPPORT DEVICES OR SYSTEMS WITHOUT THE EXPRESS WRITTEN APPROVAL OF THE PRESIDENT OF NATIONAL SEMICONDUCTOR CORPORATION. As used herein:

1. Life support devices or systems are devices or systems which, (a) are intended for surgical implant into the body, or (b) support or sustain life, and whose failure to perform, when properly used in accordance with instructions for use provided in the labeling, can be reasonably expected to result in a significant injury to the user.
2. A critical component is any component of a life support device or system whose failure to perform can be reasonably expected to cause the failure of the life support device or system, or to affect its safety or effectiveness.



National Semiconductor Corporation
 1111 West Bardin Road
 Arlington, TX 76017
 Tel: 1(800) 272-9959
 Fax: 1(800) 737-7018

National Semiconductor Europe
 Fax: (+49) 0-180-530 85 86
 Email: cnjwge@tevm2.nsc.com
 Deutsch Tel: (+49) 0-180-530 85 85
 English Tel: (+49) 0-180-532 78 32
 Français Tel: (+49) 0-180-532 93 58
 Italiano Tel: (+49) 0-180-534 16 80

National Semiconductor Hong Kong Ltd.
 19th Floor, Straight Block,
 Ocean Centre, 5 Canton Rd.
 Tsimshatsui, Kowloon
 Hong Kong
 Tel: (852) 2737-1600
 Fax: (852) 2736-9960

National Semiconductor Japan Ltd.
 Tel: 81-043-299-2309
 Fax: 81-043-299-2408

National does not assume any responsibility for use of any circuitry described, no circuit patent licenses are implied and National reserves the right at any time without notice to change said circuitry and specifications.

Copyright © Each Manufacturing Company.

All Datasheets cannot be modified without permission.

This datasheet has been download from :

www.AllDataSheet.com

100% Free DataSheet Search Site.

Free Download.

No Register.

Fast Search System.

www.AllDataSheet.com