

MSA-2011, MSA-2086

Silicon Bipolar RFIC Amplifiers



Data Sheet

Description

The MSA-2011 and MSA-2086 are high performance silicon bipolar RFIC amplifiers designed to be cascadable in 50Ω systems. The stability factor of $K > 1$ contributes to easy cascading in numerous narrow and broadband IF and RF commercial and industrial applications.

The MSA-2011 and -2086 are fabricated using a 10 GHz f_T , 25 GHz F_{MAX} , silicon bipolar RFIC process which utilizes nitride self-alignment, ion implantation, and gold metallization to achieve excellent uniformity, performance, and reliability. The use of an external bias resistor for temperature and current stability also allows bias flexibility.

Package options include the industry standard plastic surface mount SOT-143 package and the 85 mil surface mountable plastic microstripline package.

Features

MSA-2011

- Surface Mount SOT-143 Package
- 3 dB Bandwidth: DC to 1.0 GHz
- 16.2 dB Gain at 1 GHz
- 4.3 dB NF at 1 GHz
- Lead-free Option Available

MSA-2086

- Surface Mount Plastic Microstrip Package
- 3 dB Bandwidth: DC to 1.1 GHz
- 16.6 dB Gain at 1 GHz
- 3.7 dB NF at 1 GHz
- Lead-free Option Available

MSA-2011

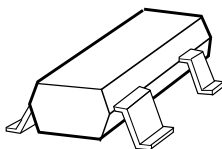

MSA-2086

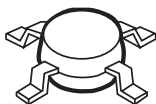

Pin Connections and Package Marking

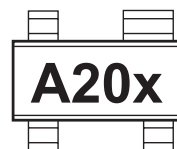

Notes:

Top View. Package Marking provides orientation and identification. "x" is the date code.

Absolute Maximum Ratings^[1]

| Parameter | MSA-2011 | MSA-2086 |
|------------------------------------|------------------------|------------------------|
| Device Current | 50 mA | 60 mA |
| Power Dissipation ^[2,3] | 250 mW ^[3a] | 325 mW ^[3c] |
| RF Input Power | +13 dBm | +13 dBm |
| Junction Temperature | 150°C | 150°C |
| Storage Temperature | -65 to 150°C | -65 to 150°C |
| Thermal Resistance: θ_{jc} | 500°C/W | 115°C/W |

Notes:

- Permanent damage may occur if any of these limits are exceeded.
- $T_{CASE} = 25^{\circ}\text{C}$.
- Derate at 2.0 mW/°C for $T_C > 25^{\circ}\text{C}$.
 - Derate at 6.5 mW/°C for $T_C > 149^{\circ}\text{C}$.
 - Derate at 8.7 mW/°C for $T_C > 112^{\circ}\text{C}$.

Typical Biasing Configuration

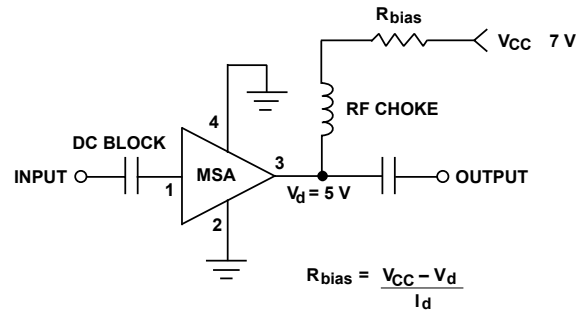

Electrical Specifications, $T_A = 25^{\circ}\text{C}$

$I_D = 32 \text{ mA}$, $Z_0 = 50 \Omega$

| Symbol | Parameters and Test Conditions | Units | MSA-2011 | | | MSA-2086 | | |
|--------------|-----------------------------------------------------------------------------|-------|----------|----------------------|------|----------|----------------------|------|
| | | | Min. | Typ. | Max. | Min. | Typ. | Max. |
| G_p | Power Gain ($ S_{21} ^2$) f = 0.1 GHz f = 0.5 GHz f = 1.0 GHz | dB | 15.0 | 18.9 18.1 16.2 | | 15.0 | 19.2 18.3 16.6 | |
| ΔG_p | Gain Flatness f = 0.1 to 0.6 GHz | dB | | ± 0.6 | | | ± 0.6 | |
| f_{3dB} | 3 dB Bandwidth | GHz | | 1.0 | | | 1.1 | |
| VSWR | Input VSWR f = 0.1 to 3.0 GHz | | | 1.3:1 | | | 1.2:1 | |
| | Output VSWR f = 0.1 to 3.0 GHz | | | 1.4:1 | | | 1.5:1 | |
| P_{1dB} | Power Output @ 1 dB Gain Compression: f = 1.0 GHz | dBm | | 9.0 | | | 9.0 | |
| NF | 50 Ω Noise Figure f = 1.0 GHz | dB | | 4.3 | | | 3.7 | |
| IP_3 | Third Order Intercept Point f = 1.0 GHz | dBm | | 22 | | | 22 | |
| t_d | Group Delay f = 1.0 GHz | psec | | 143 | | | 143 | |
| V_D | Device Voltage $T_C = 25^{\circ}\text{C}$ | V | 4.0 | 5.0 | 6.0 | 4.5 | 5.0 | 6.3 |
| dV/dT | Device Voltage Temperature Coefficient | mV/°C | | -9.3 | | | -9.3 | |

Typical Performance for MSA-2011

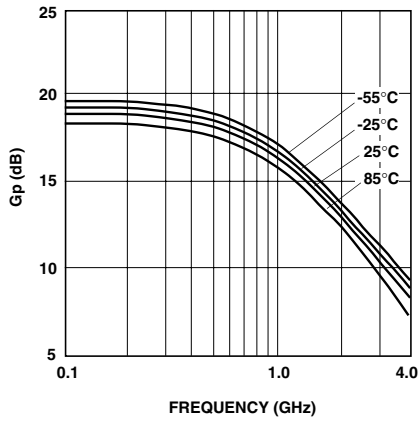

Figure 1. Power Gain vs. Frequency at Four Temperatures, $I_D = 32$ mA.

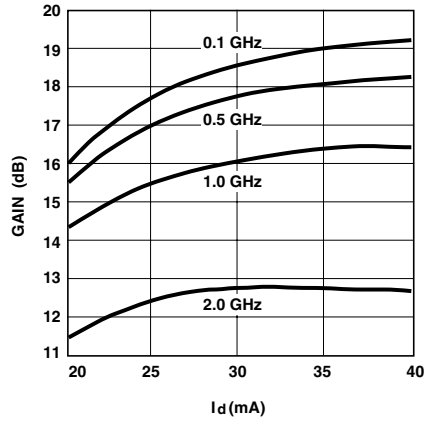

Figure 2. Power Gain vs. Current at 25°C.

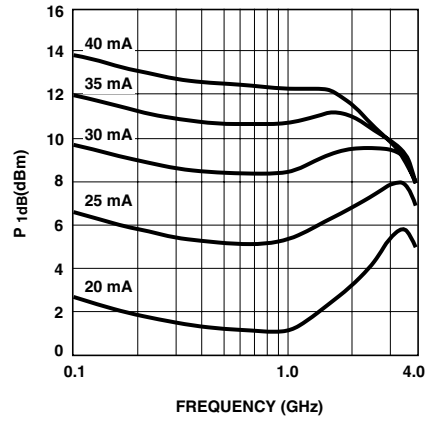

Figure 3. Typical P_{1dB} vs. Frequency at 25°C.

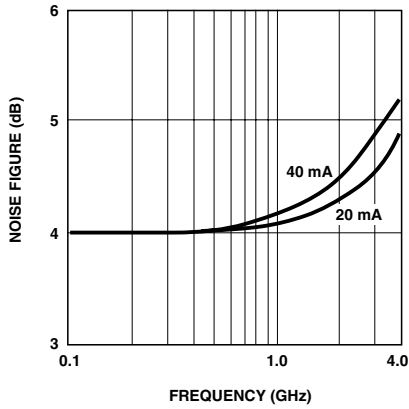

Figure 4. Noise Figure vs. Frequency at $I_D = 32$ mA.

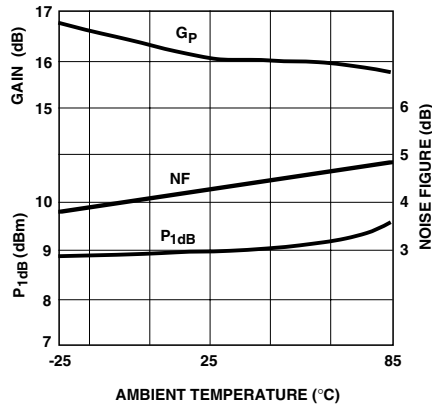

Figure 5. Power Gain, Noise Figure, and P_{1dB} vs. Temperature at 1 GHz and $I_D = 32$ mA.

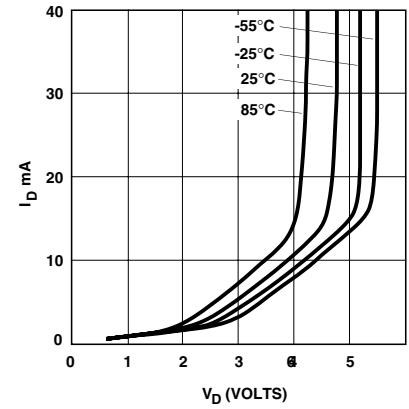

Figure 6. I_D vs. V_D at Four Temperatures.

Typical Scattering Parameters at $T_A = 25^\circ\text{C}$, for MSA-2011

$I_D = 32\text{ mA}$, $Z_o = 50\ \Omega$

| Frequency (GHz) | S_{11} | | S_{21} | | | S_{12} | | | S_{22} | |
|--------------------|----------|------|----------|------|------|----------|-------|------|----------|------|
| | Mag. | Ang. | (dB) | Mag. | Ang. | (dB) | Mag. | Ang. | Mag. | Ang. |
| 0.1 | 0.05 | 7 | 18.9 | 8.81 | 172 | -22.6 | 0.074 | 4 | 0.17 | -13 |
| 0.2 | 0.05 | 9 | 18.8 | 8.73 | 165 | -22.4 | 0.076 | 8 | 0.17 | -23 |
| 0.3 | 0.06 | 3 | 18.6 | 8.52 | 157 | -22.2 | 0.077 | 11 | 0.17 | -34 |
| 0.4 | 0.06 | 1 | 18.3 | 8.25 | 150 | -22.0 | 0.079 | 15 | 0.17 | -43 |
| 0.5 | 0.06 | 0 | 18.1 | 8.00 | 143 | -21.7 | 0.082 | 17 | 0.17 | -52 |
| 0.6 | 0.07 | -5 | 17.7 | 7.65 | 137 | -21.4 | 0.085 | 20 | 0.17 | -61 |
| 0.7 | 0.07 | -8 | 17.3 | 7.33 | 131 | -21.1 | 0.088 | 22 | 0.17 | -68 |
| 0.8 | 0.08 | -12 | 16.9 | 7.02 | 125 | -20.7 | 0.092 | 24 | 0.17 | -74 |
| 0.9 | 0.08 | -18 | 16.3 | 6.70 | 120 | -20.3 | 0.096 | 26 | 0.18 | -80 |
| 1.0 | 0.08 | -22 | 16.2 | 6.43 | 115 | -20.0 | 0.100 | 28 | 0.18 | -85 |
| 1.5 | 0.09 | -46 | 14.3 | 5.16 | 93 | -18.2 | 0.123 | 31 | 0.18 | -102 |
| 2.0 | 0.11 | -69 | 12.6 | 4.26 | 75 | -16.7 | 0.146 | 31 | 0.17 | -109 |
| 2.5 | 0.11 | -93 | 11.2 | 3.64 | 59 | -15.6 | 0.167 | 29 | 0.17 | -111 |
| 3.0 | 0.12 | -118 | 10.1 | 3.18 | 45 | -14.7 | 0.185 | 26 | 0.18 | -112 |
| 3.5 | 0.12 | -152 | 9.1 | 2.85 | 31 | -13.9 | 0.202 | 24 | 0.19 | -116 |
| 4.0 | 0.15 | 174 | 8.1 | 2.55 | 18 | -13.3 | 0.216 | 21 | 0.20 | -124 |
| 4.5 | 0.22 | 147 | 7.4 | 2.33 | 5 | -12.8 | 0.231 | 19 | 0.22 | -133 |
| 5.0 | 0.30 | 127 | 6.5 | 2.11 | -8 | -12.2 | 0.246 | 17 | 0.25 | -145 |
| 5.5 | 0.39 | 113 | 5.6 | 1.90 | -20 | -11.4 | 0.268 | 14 | 0.30 | -157 |
| 6.0 | 0.45 | 100 | 4.5 | 1.68 | -32 | -10.7 | 0.292 | 10 | 0.35 | -168 |

Ordering Information

| Part Numbers | No. of Devices | Comments |
|---------------|----------------|----------|
| MSA-2011-BLK | 100 | Bulk |
| MSA-2011-BLKG | 100 | Bulk |
| MSA-2011-TR1 | 3000 | 7" Reel |
| MSA-2011-TR1G | 3000 | 7" Reel |
| MSA-2011-TR2 | 10000 | 13" Reel |
| MSA-2011-TR2G | 10000 | 13" Reel |

Note: Order part number with a "G" suffix if lead-free option is desired.

Typical Performance for MSA-2086

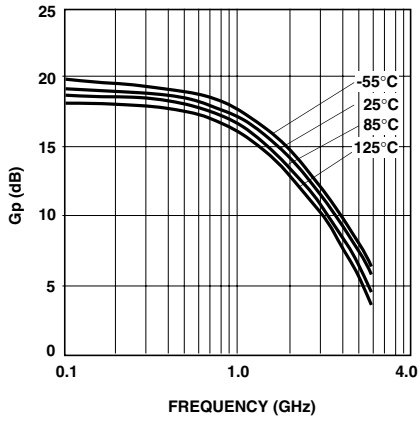

Figure 1. Power Gain vs. Frequency at Four Temperatures, $I_D = 32$ mA.

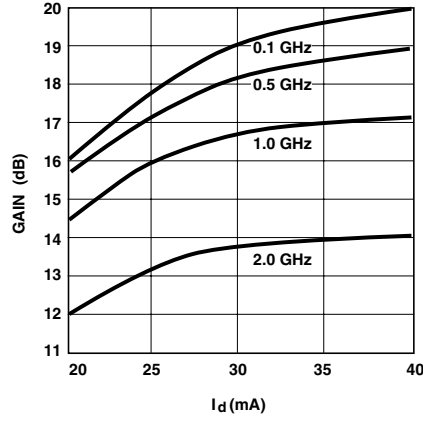

Figure 2. Power Gain vs. Current at 25°C.

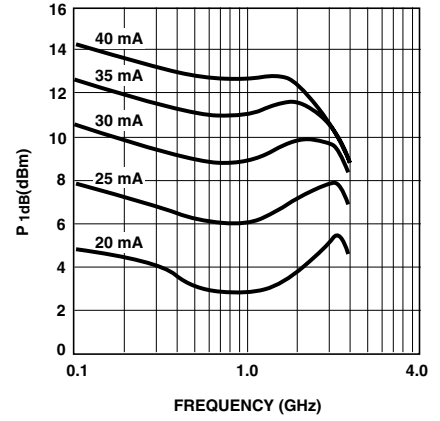

Figure 3. Typical P_{1dB} vs. Frequency at 25°C.

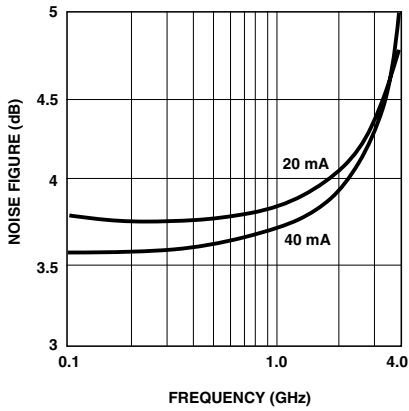

Figure 4. Noise Figure vs. Frequency at $I_D = 32$ mA.

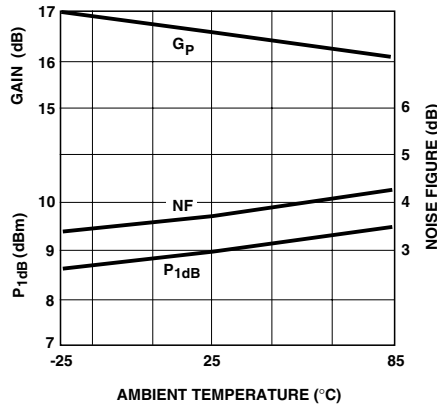

Figure 5. Power Gain, Noise Figure, and P_{1dB} vs. Temperature at 1 GHz and $I_D = 32$ mA.

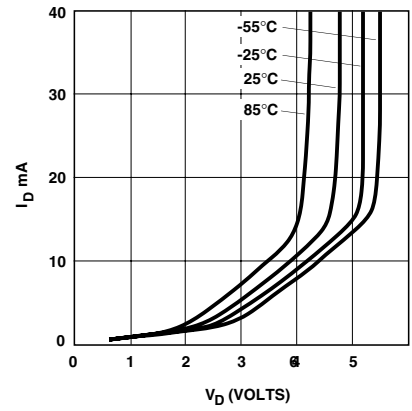

Figure 6. I_D vs. V_b at Four Temperatures.

Typical Scattering Parameters at $T_A = 25^\circ\text{C}$, for MSA-2086

$I_D = 32\text{ mA}$, $Z_o = 50\ \Omega$

| Frequency (GHz) | S_{11} | | S_{21} | | | S_{12} | | | S_{22} | |
|--------------------|----------|------|----------|------|------|----------|-------|------|----------|------|
| | Mag. | Ang. | (dB) | Mag. | Ang. | (dB) | Mag. | Ang. | Mag. | Ang. |
| 0.1 | 0.06 | 1 | 19.2 | 9.08 | 172 | -22.8 | 0.073 | 4 | 0.18 | -15 |
| 0.2 | 0.05 | -5 | 19.1 | 8.98 | 165 | -22.6 | 0.074 | 7 | 0.17 | -26 |
| 0.3 | 0.05 | -10 | 18.9 | 8.80 | 157 | -22.4 | 0.076 | 10 | 0.17 | -37 |
| 0.4 | 0.07 | -15 | 18.7 | 8.57 | 150 | -22.2 | 0.078 | 13 | 0.19 | -45 |
| 0.5 | 0.09 | -18 | 18.4 | 8.29 | 143 | -21.9 | 0.081 | 15 | 0.19 | -53 |
| 0.6 | 0.09 | -22 | 18.1 | 7.99 | 136 | -21.6 | 0.084 | 18 | 0.20 | -62 |
| 0.7 | 0.08 | -23 | 17.7 | 7.66 | 130 | -21.2 | 0.087 | 20 | 0.20 | -71 |
| 0.8 | 0.08 | -31 | 17.4 | 7.37 | 124 | -20.8 | 0.091 | 21 | 0.20 | -80 |
| 0.9 | 0.08 | -34 | 17.0 | 7.07 | 118 | -20.5 | 0.095 | 23 | 0.20 | -87 |
| 1.0 | 0.08 | -44 | 16.6 | 6.78 | 112 | -20.1 | 0.099 | 23 | 0.19 | -94 |
| 1.5 | 0.07 | -71 | 14.8 | 5.49 | 88 | -18.2 | 0.123 | 24 | 0.19 | -125 |
| 2.0 | 0.06 | -99 | 13.3 | 4.60 | 68 | -16.7 | 0.146 | 22 | 0.17 | -145 |
| 2.5 | 0.07 | -176 | 11.9 | 3.93 | 50 | -15.5 | 0.167 | 17 | 0.18 | -174 |
| 3.0 | 0.14 | 151 | 10.7 | 3.42 | 31 | -14.7 | 0.185 | 10 | 0.20 | 172 |
| 3.5 | 0.20 | 125 | 9.5 | 2.98 | 15 | -14.2 | 0.196 | 3 | 0.24 | 153 |
| 4.0 | 0.29 | 106 | 8.3 | 2.61 | -1 | -13.8 | 0.204 | -3 | 0.28 | 139 |
| 4.5 | 0.39 | 96 | 7.3 | 2.31 | -15 | -13.6 | 0.210 | -8 | 0.32 | 129 |
| 5.0 | 0.51 | 90 | 6.3 | 2.08 | -29 | -13.3 | 0.217 | -12 | 0.36 | 124 |
| 5.5 | 0.62 | 83 | 5.4 | 1.85 | -43 | -13.0 | 0.225 | -16 | 0.40 | 119 |
| 6.0 | 0.69 | 75 | 4.3 | 1.64 | -58 | -12.7 | 0.233 | -22 | 0.47 | 113 |

Ordering Information

| Part Numbers | No. of Devices | Comments |
|---------------|----------------|----------|
| MSA-2086-BLK | 100 | Bulk |
| MSA-2086-BLKG | 100 | Bulk |
| MSA-2086-TR1 | 1000 | 7" Reel |
| MSA-2086-TR1G | 1000 | 7" Reel |
| MSA-2086-TR2 | 4000 | 13" Reel |
| MSA-2086-TR2G | 4000 | 13" Reel |

Note: Order part number with a "G" suffix if lead-free option is desired.

Outline Drawings

SOT-143

86

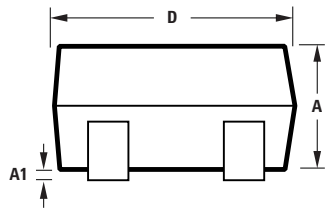
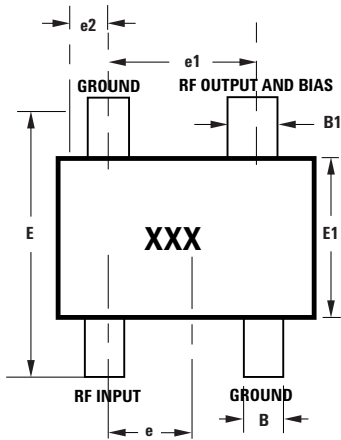

Notes:
 XXX-package marking
 Drawings are not to scale

| SYMBOL | DIMENSIONS (mm) | |
|--------|-----------------|-------|
| | MIN. | MAX. |
| A | 0.79 | 1.097 |
| A1 | 0.013 | 0.10 |
| B | 0.36 | 0.54 |
| B1 | 0.76 | 0.92 |
| C | 0.086 | 0.152 |
| D | 2.80 | 3.06 |
| E1 | 1.20 | 1.40 |
| e | 0.89 | 1.02 |
| e1 | 1.78 | 2.04 |
| e2 | 0.45 | 0.60 |
| E | 2.10 | 2.65 |
| L | 0.45 | 0.69 |

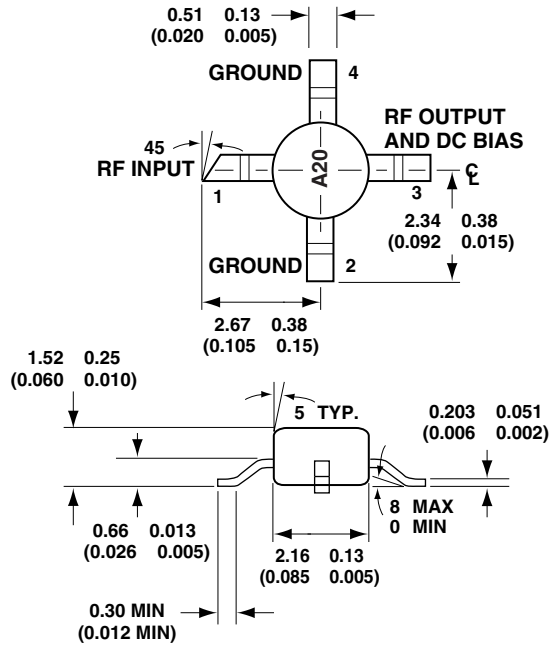

DIMENSIONS ARE IN MILLIMETERS (INCHES)

For product information and a complete list of distributors, please go to our web site: www.avagotech.com

Avago, Avago Technologies, and the A logo are trademarks of Avago Technologies, Limited in the United States and other countries. Data subject to change. Copyright © 2006 Avago Technologies, Limited. All rights reserved. Obsoletes 5989-4457EN AV02-0791EN - October 30, 2007

