

LP2982

Micropower 50 mA Ultra Low-Dropout Regulator

General Description

The LP2982 is a 50 mA, fixed-output voltage regulator designed to provide ultra low dropout and lower noise in battery powered applications.

Using an optimized VIP™ (Vertically Integrated PNP) process, the LP2982 delivers unequaled performance in all specifications critical to battery-powered designs:

Dropout Voltage: Typically 120 mV @ 50 mA load, and 7 mV @ 1 mA load.

Ground Pin Current: Typically 375 μ A @ 50 mA load, and 80 μ A @ 1 mA load.

Sleep Mode: Less than 1 μ A quiescent current when on/off pin is pulled low.

Smallest Possible Size: SOT-23 and micro SMD packages use absolute minimum board space.

Precision Output: 1.0% tolerance output voltages available (A grade).

Low Noise: By adding an external bypass capacitor, output noise can be reduced to 30 μ V (typical).

Ten output voltage versions, from 2.5V to 5.0V, are available as standard products.

Features

- Ultra low dropout voltage
- Guaranteed 50 mA output current
- Typical dropout voltage 180 mV @ 80 mA
- Smallest possible size (SOT-23, micro SMD package)
- Requires minimum external components
- < 1 μ A quiescent current when shutdown
- Low ground pin current at all loads
- Output voltage accuracy 1.0% (A Grade)
- High peak current capability (150 mA typical)
- Wide supply voltage range (16V max)
- Low Z_{OUT} 0.3 Ω typical (10 Hz to 1 MHz)
- Overtemperature/overcurrent protection
- -40°C to +125°C junction temperature range
- Custom voltages available

Applications

- Cellular Phone
- Palmtop/Laptop Computer
- Personal Digital Assistant (PDA)
- Camcorder, Personal Stereo, Camera

Block Diagram

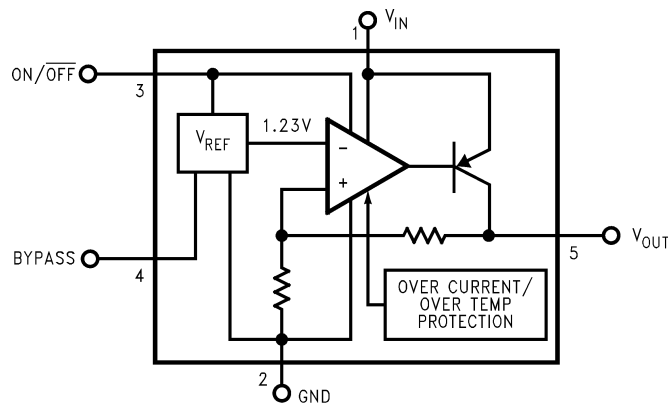

DS012679-1

VIP™ is a trademark of National Semiconductor Corporation.

Connection Diagrams

5-Lead Small Outline Package (M5)

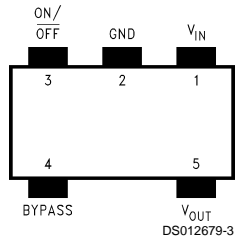

Top View
 See NS Package Number MF05A
 For ordering information see *Table 1*

micro SMD, 5 Bump Package (BPA05)

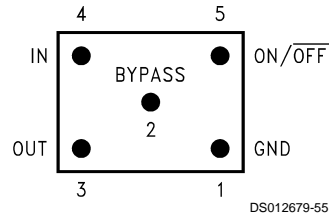

Bottom View
 See NS Package Number BPA05

Basic Application Circuit

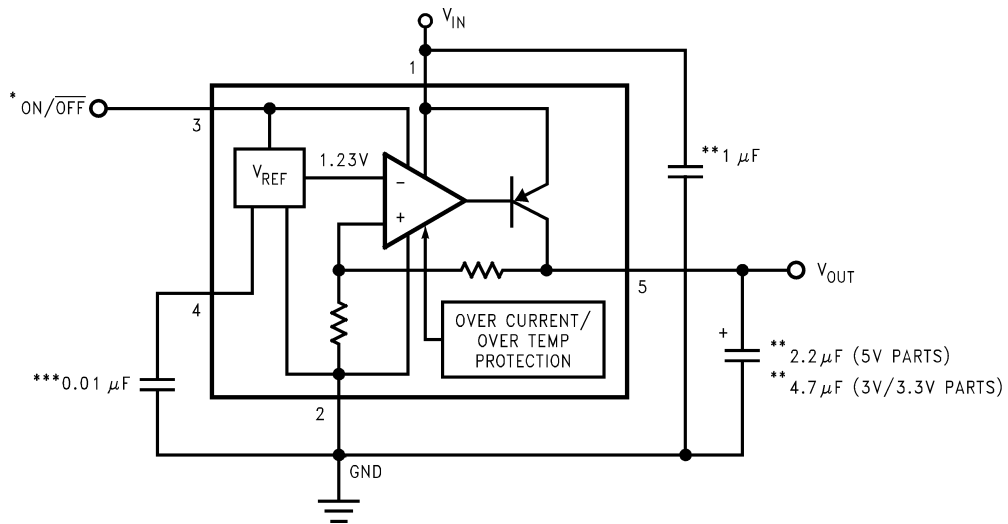

DS012679-2

*ON/OFF input must be actively terminated. Tie to V_{IN} if this function is not to be used.

**Minimum capacitance is shown to insure stability over full load current range. More capacitance provides superior dynamic performance (see Application Hints).

***See Application Hints.

Ordering Information

TABLE 1. Package Marking and Ordering Information

Output Voltage (V)	Grade	Order Information	Package Marking	Supplied as:
5-Lead Small Outline Package (M5)				
2.5	A	LP2982AIM5X-2.5	L58A	3000 Units on Tape and Reel
2.5	A	LP2982AIM5-2.5	L58A	1000 Units on Tape and Reel
2.5	STD	LP2982IM5X-2.5	L58B	3000 Units on Tape and Reel
2.5	STD	LP2982IM5-2.5	L58B	1000Units on Tape and Reel
2.6	A	LP2982AIM5X-2.6	LBYA	3000 Units on Tape and Reel
2.6	A	LP2982AIM5-2.6	LBYA	1000 Units on Tape and Reel
2.6	STD	LP2982IM5X-2.6	LBYB	3000 Units on Tape and Reel
2.6	STD	LP2982IM5-2.6	LBYB	1000Units on Tape and Reel
2.8	A	LP2982AIM5X-2.8	L60A	3000 Units on Tape and Reel
2.8	A	LP2982AIM5-2.8	L60A	1000 Units on Tape and Reel
2.8	STD	LP2982IM5X-2.8	L60B	3000 Units on Tape and Reel
2.8	STD	LP2982IM5-2.8	L60B	1000 Units on Tape and Reel
3.0	A	LP2982AIM5X-3.0	L20A	3000 Units on Tape and Reel
3.0	A	LP2982AIM5-3.0	L20A	1000 Units on Tape and Reel
3.0	STD	LP2982IM5X-3.0	L20B	3000 Units on Tape and Reel
3.0	STD	LP2982IM5-3.0	L20B	1000 Units on Tape and Reel
3.3	A	LP2982AIM5X-3.3	L19A	3000 Units on Tape and Reel
3.3	A	LP2982AIM5-3.3	L19A	1000 Units on Tape and Reel
3.3	STD	LP2982IM5X-3.3	L19B	3000 Units on Tape and Reel
3.3	STD	LP2982IM5-3.3	L19B	1000 Units on Tape and Reel
3.6	A	LP2982AIM5X-3.6	L0BA	3000 Units on Tape and Reel
3.6	A	LP2982AIM5-3.6	L0BA	1000 Units on Tape and Reel
3.6	STD	LP2982IM5X-3.6	L0BB	3000 Units on Tape and Reel
3.6	STD	LP2982IM5-3.6	L0BB	1000 Units on Tape and Reel
3.8	A	LP2982AIM5X-3.8	L76A	3000 Units on Tape and Reel
3.8	A	LP2982AIM5-3.8	L76A	1000 Units on Tape and Reel
3.8	STD	LP2982IM5X-3.8	L76B	3000 Units on Tape and Reel
3.8	STD	LP2982IM5-3.8	L76B	1000 Units on Tape and Reel
4.0	A	LP2982AIM5X-4.0	L29A	3000 Units on Tape and Reel
4.0	A	LP2982AIM5-4.0	L29A	1000 Units on Tape and Reel
4.0	STD	LP2982IM5X-4.0	L29B	3000 Units on Tape and Reel
4.0	STD	LP2982IM5-4.0	L29B	1000 Units on Tape and Reel
4.5	A	LP2982AIM5X-4.5	LA8A	3000 Units on Tape and Reel
4.5	A	LP2982AIM5-4.5	LA8A	1000 Units on Tape and Reel
4.5	STD	LP2982IM5X-4.5	LA8B	3000 Units on Tape and Reel
4.5	STD	LP2982IM5-4.5	LA8B	1000 Units on Tape and Reel
4.7	A	LP2982AIM5X-4.7	L0HA	3000 Units on Tape and Reel
4.7	A	LP2982AIM5-4.7	L0HA	1000 Units on Tape and Reel
4.7	STD	LP2982IM5X-4.7	L0HB	3000 Units on Tape and Reel
4.7	STD	LP2982IM5-4.7	L0HB	1000 Units on Tape and Reel
5.0	A	LP2982AIM5X-5.0	L18A	3000 Units on Tape and Reel
5.0	A	LP2982AIM5-5.0	L18A	1000 Units on Tape and Reel
5.0	STD	LP2982IM5X-5.0	L18B	3000 Units on Tape and Reel
5.0	STD	LP2982IM5-5.0	L18B	1000 Units on Tape and Reel
5.3	A	LP2982AIM5X-5.3	LBZA	3000 Units on Tape and Reel

Ordering Information (Continued)**TABLE 1. Package Marking and Ordering Information** (Continued)

Output Voltage (V)	Grade	Order Information	Package Marking	Supplied as:
5-Lead Small Outline Package (M5)				
5.3	A	LP2982AIM5-5.3	LBZA	1000 Units on Tape and Reel
5.3	STD	LP2982IM5X-5.3	LBZB	3000 Units on Tape and Reel
5.3	STD	LP2982IM5-5.3	LBZB	1000 Units on Tape and Reel
micro SMD, 5 Bump Package (BPA05)				
2.8	A	LP2982AIBP-2.8		250 Units on Tape and Reel
2.8	A	LP2982AIBPX-2.8		3000 Units on Tape and Reel
2.8	STD	LP2982IBP-2.8		250 Units on Tape and Reel
2.8	STD	LP2982IBPX-2.8		3000 Units on Tape and Reel
3.0	A	LP2982AIBP-3.0		250 Units on Tape and Reel
3.0	A	LP2982AIBPX-3.0		3000 Units on Tape and Reel
3.0	STD	LP2982IBP-3.0		250 Units on Tape and Reel
3.0	STD	LP2982IBPX-3.0		3000 Units on Tape and Reel

Absolute Maximum Ratings (Note 1)

If Military/Aerospace specified devices are required, please contact the National Semiconductor Sales Office/Distributors for availability and specifications.

Storage Temperature Range	-65°C to +150°C
Operating Junction Temperature Range	-40°C to +125°C
Lead Temperature (Soldering, 5 sec.)	260°C
ESD Rating (Note 2)	2 kV

Power Dissipation (Note 3)

Input Supply Voltage (Survival)	-0.3V to +16V	Internally Limited
Input Supply Voltage (Operating)	2.1V to +16V	
Shutdown Input Voltage (Survival)	-0.3V to +16V	
Output Voltage (Survival, (Note 4))	-0.3V to +9V	
I _{OUT} (Survival)	Short Circuit Protected	
Input-Output Voltage (Survival, (Note 5))	-0.3V to +16V	

Electrical Characteristics

Limits in standard typeface are for T_J = 25°C, and limits in **boldface type** apply over the full operating temperature range. Unless otherwise specified: V_{IN} = V_{O(NOM)} + 1V, I_L = 1 mA, C_{IN} = 1 μF, C_{OUT} = 4.7 μF, V_{ON/OFF} = 2V.

Symbol	Parameter	Conditions	Typ	LP2982AI-X.X (Note 6)		LP2982I-X.X (Note 6)		Units
				Min	Max	Min	Max	
ΔV _O	Output Voltage Tolerance	I _L = 1 mA		-1.0	+1.0	-1.5	+1.5	%V _{NOM}
		1 mA < I _L < 50 mA		-1.5 -2.0	+1.5 +2.0	-2.0 -3.5	+2.0 +3.5	
$\frac{\Delta V_O}{\Delta V_{IN}}$	Output Voltage Line Regulation	V _{O(NOM)} + 1V ≤ V _{IN} ≤ 16V	0.007		0.014 0.032		0.014 0.032	%/V
V _{IN} -V _O	Dropout Voltage (Note 7)	I _L = 0	1		3 5		3 5	mV
		I _L = 1 mA	7		10 15		10 15	
		I _L = 10 mA	40		60 90		60 90	
		I _L = 50 mA	120		150 225		150 225	
I _{GND}	Ground Pin Current	I _L = 0	65		95 125		95 125	μA
		I _L = 1 mA	80		110 170		110 170	
		I _L = 10 mA	140		220 460		220 460	
		I _L = 50 mA	375		600 1200		600 1200	
		V _{ON/OFF} < 0.3V	0.01		0.8		0.8	
		V _{ON/OFF} < 0.15V	0.10		2.0		2.0	
V _{ON/OFF}	ON/OFF Input Voltage (Note 8)	High = O/P ON	1.4	1.6		1.6		V
		Low = O/P OFF	0.55		0.15		0.15	
I _{ON/OFF}	ON/OFF Input Current	V _{ON/OFF} = 0	0.01		-2		-2	μA
		V _{ON/OFF} = 5V	5		15		15	
I _{O(PK)}	Peak Output Current	V _{OUT} ≥ V _{O(NOM)} - 5%	150	100		100		mA
V _{IN} -V _O	Dropout Voltage	I _L = 80 mA			225		225	mV
					325		325	
I _{GND}	Ground Pin Current	I _L = 80 mA			750		750	μA
					1400		1400	
e _n	Output Noise Voltage (RMS)	BW = 300 Hz-50 kHz, C _{OUT} = 10 μF C _{BYPASS} = 0.01 μF	30					μV

Electrical Characteristics (Continued)

Limits in standard typeface are for $T_J = 25^\circ\text{C}$, and limits in **boldface type** apply over the full operating temperature range. Unless otherwise specified: $V_{IN} = V_{O(NOM)} + 1\text{V}$, $I_L = 1\text{ mA}$, $C_{IN} = 1\ \mu\text{F}$, $C_{OUT} = 4.7\ \mu\text{F}$, $V_{ON/OFF} = 2\text{V}$.

Symbol	Parameter	Conditions	Typ	LP2982AI-X.X (Note 6)		LP2982I-X.X (Note 6)		Units
				Min	Max	Min	Max	
$\frac{\Delta V_{OUT}}{\Delta V_{IN}}$	Ripple Rejection	$f = 1\text{ kHz}$ $C_{OUT} = 10\ \mu\text{F}$	45					dB
$I_{O(MAX)}$	Short Circuit Current	$R_L = 0$ (Steady State) (Note 9)	150					mA

Note 1: Absolute maximum ratings indicate limits beyond which damage to the component may occur. Electrical specifications do not apply when operating the device outside of its rated operating conditions.

Note 2: The ESD rating of pins 3 and 4 is 1 kV.

Note 3: The maximum allowable power dissipation is a function of the maximum junction temperature, $T_{J(MAX)}$, the junction-to-ambient thermal resistance, θ_{JA} , and the ambient temperature, T_A . The maximum allowable power dissipation at any ambient temperature is calculated using:

$$P (MAX) = \frac{T_{J(MAX)} - T_A}{\theta_{JA}}$$

The value of θ_{JA} for the SOT-23 package is 220°C/W and the micro SMD package is 320°C/W . Exceeding the maximum allowable power dissipation will cause excessive die temperature, and the regulator will go into thermal shutdown.

Note 4: If used in a dual-supply system where the regulator load is returned to a negative supply, the LP2982 output must be diode-clamped to ground.

Note 5: The output PNP structure contains a diode between the V_{IN} and V_{OUT} terminals that is normally reverse-biased. Reversing the polarity from V_{IN} to V_{OUT} will turn on this diode.

Note 6: temperature range are guaranteed through correlation using Statistical Quality Control (SQC) methods. The limits are used to calculate National's Average Outgoing Quality Level (AOQL).

Note 7: Dropout voltage is defined as the input to output differential at which the output voltage drops 100 mV below the value measured with a 1V differential.

Note 8: The ON/OFF inputs must be properly driven to prevent possible misoperation. For details, refer to Application Hints.

Note 9: See Typical Performance Characteristics curves.

Typical Performance Characteristics Unless otherwise specified: $T_A = 25^\circ\text{C}$, $V_{IN} = V_{O(NOM)} + 1\text{V}$, $C_{OUT} = 4.7\ \mu\text{F}$, $C_{IN} = 1\ \mu\text{F}$, all voltage options, ON/OFF pin tied to V_{IN} .

Output Voltage vs Temperature

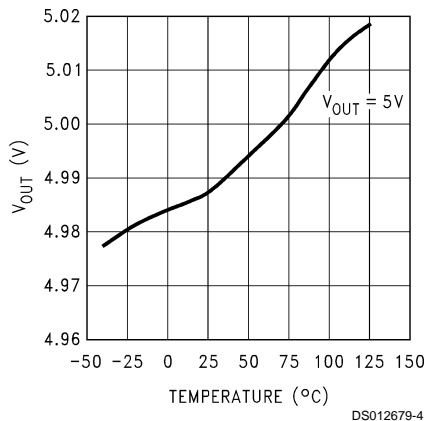

Output Voltage vs Temperature

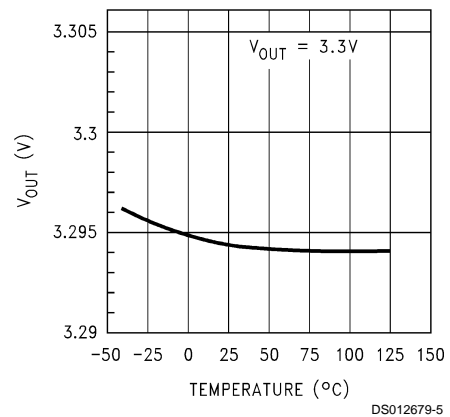

Typical Performance Characteristics

Unless otherwise specified: $T_A = 25^\circ\text{C}$, $V_{IN} = V_{O(NOM)} + 1\text{V}$, $C_{OUT} = 4.7\ \mu\text{F}$, $C_{IN} = 1\ \mu\text{F}$, all voltage options, ON/OFF pin tied to V_{IN} . (Continued)

Output Voltage vs Temperature

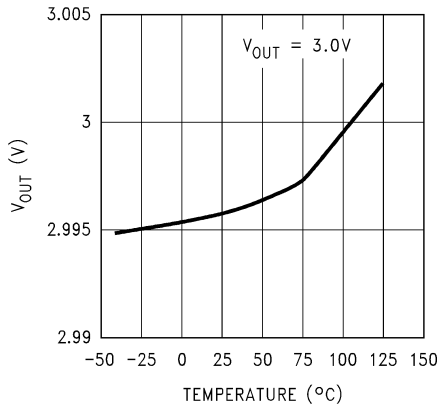

Dropout Characteristics

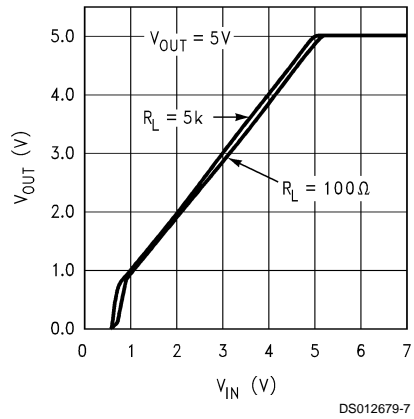

Dropout Characteristics

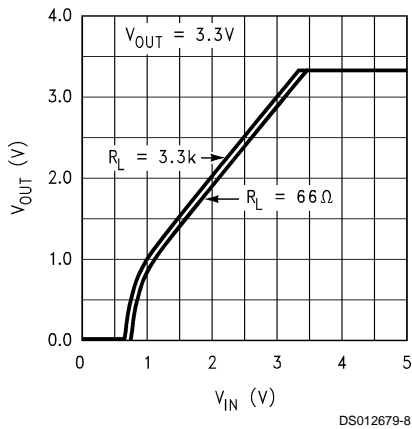

Dropout Characteristics

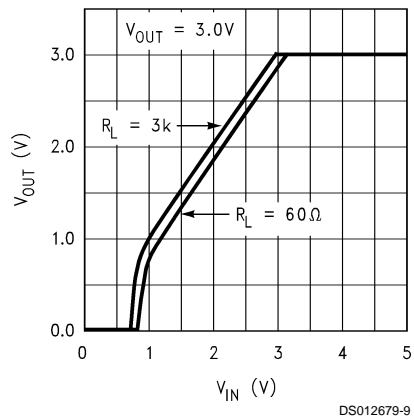

Dropout Voltage vs Temperature

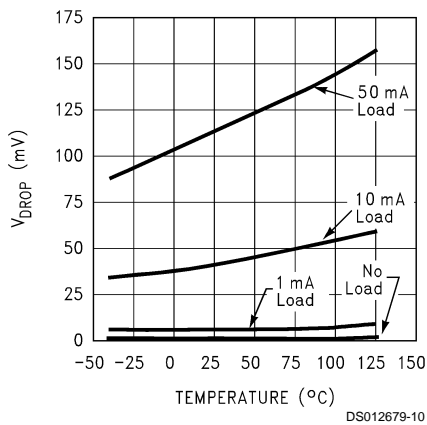

Dropout Voltage vs Load Current

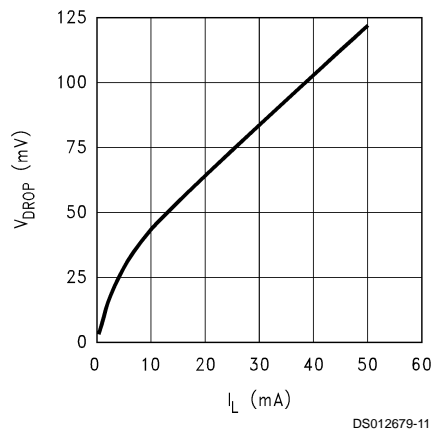

Typical Performance Characteristics Unless otherwise specified: $T_A = 25^\circ\text{C}$, $V_{IN} = V_{O(NOM)} + 1\text{V}$, $C_{OUT} = 4.7\ \mu\text{F}$, $C_{IN} = 1\ \mu\text{F}$, all voltage options, ON/OFF pin tied to V_{IN} . (Continued)

Ground Pin Current vs Temperature

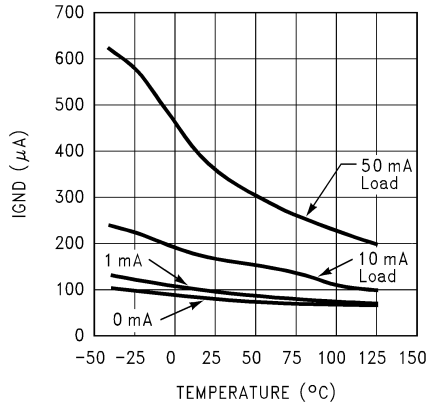

DS012679-12

Ground Pin Current vs Load Current

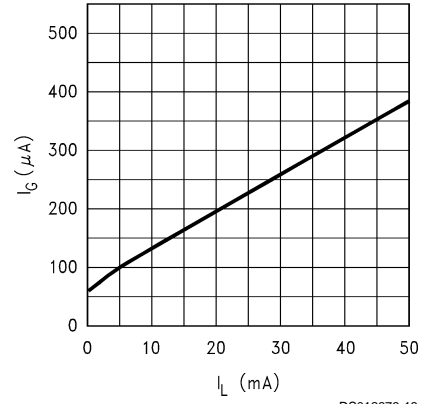

DS012679-13

Input Current vs V_{IN}

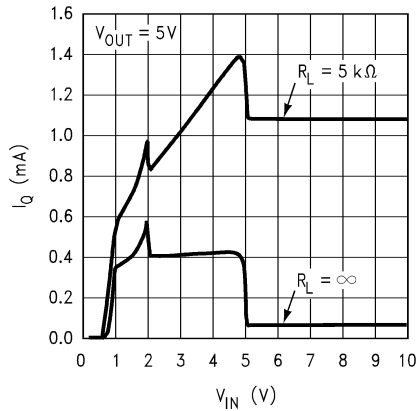

DS012679-14

Input Current vs V_{IN}

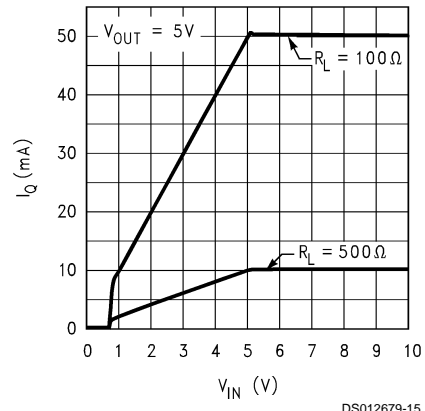

DS012679-15

Line Transient Response

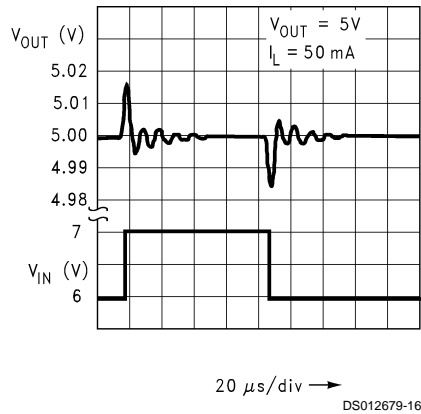

DS012679-16

Line Transient Response

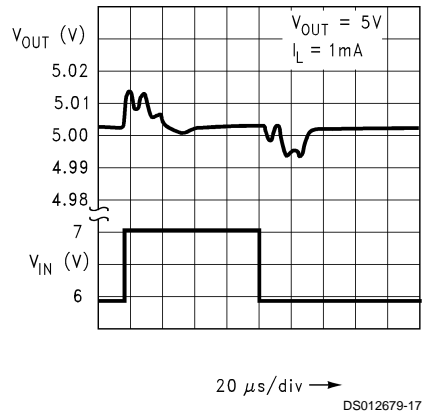

DS012679-17

Typical Performance Characteristics

Unless otherwise specified: $T_A = 25^\circ\text{C}$, $V_{IN} = V_{O(NOM)} + 1\text{V}$, $C_{OUT} = 4.7\ \mu\text{F}$, $C_{IN} = 1\ \mu\text{F}$, all voltage options, ON/OFF pin tied to V_{IN} . (Continued)

Load Transient Response

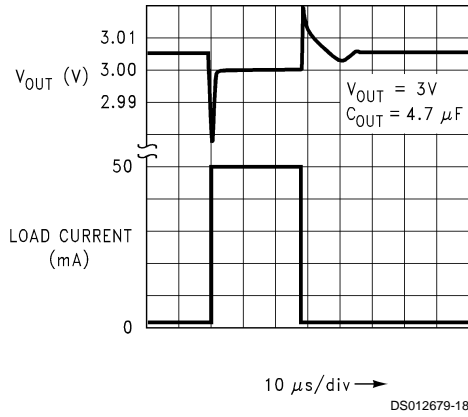

Load Transient Response

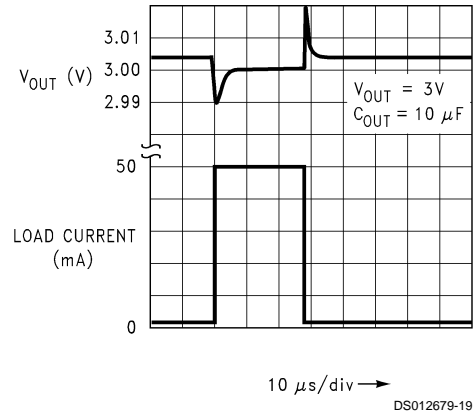

Load Transient Response

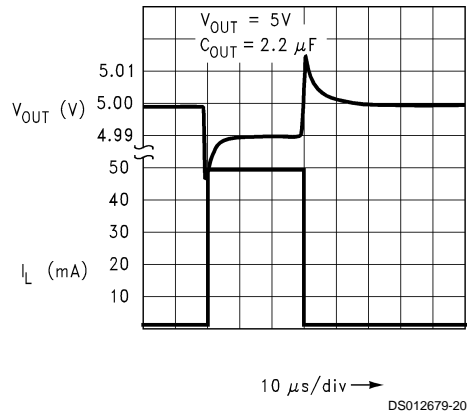

Load Transient Response

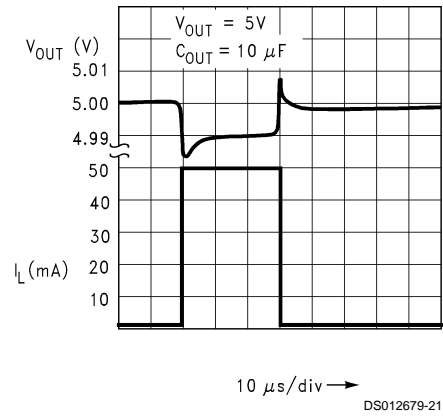

Short Circuit Current

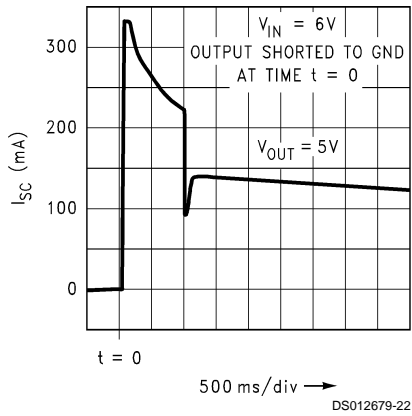

Instantaneous Short Circuit Current vs Temperature

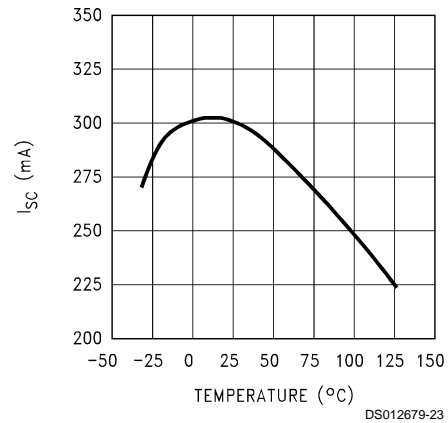

Typical Performance Characteristics Unless otherwise specified: $T_A = 25^\circ\text{C}$, $V_{IN} = V_{O(NOM)} + 1\text{V}$, $C_{OUT} = 4.7\ \mu\text{F}$, $C_{IN} = 1\ \mu\text{F}$, all voltage options, ON/OFF pin tied to V_{IN} . (Continued)

Short Circuit Current

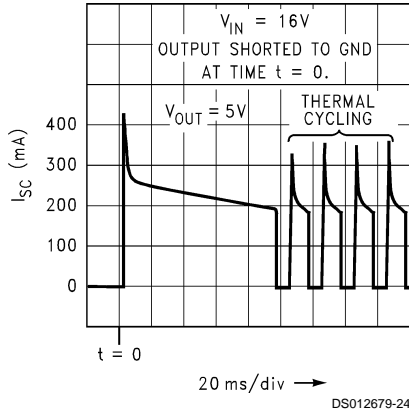

Instantaneous Short Circuit Current vs Output Voltage

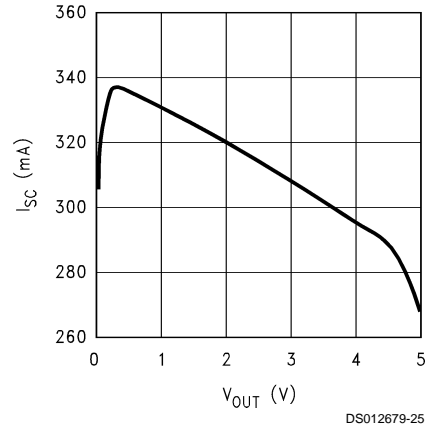

Output Impedance vs Frequency

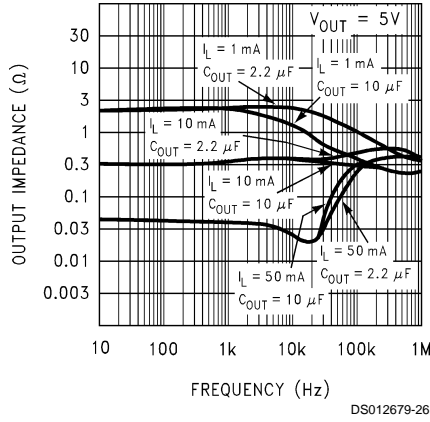

Output Impedance vs Frequency

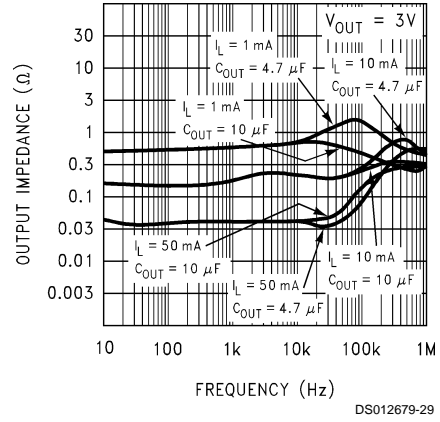

ON/OFF Pin Current vs $V_{ON/OFF}$

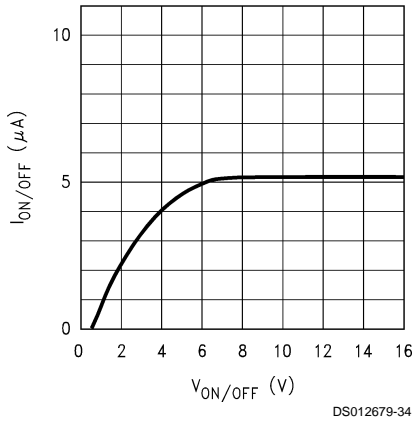

ON/OFF Threshold vs Temperature

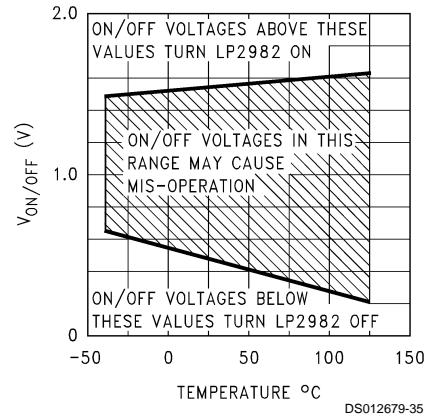

Typical Performance Characteristics Unless otherwise specified: $T_A = 25^\circ\text{C}$, $V_{IN} = V_{O(NOM)} + 1\text{V}$, $C_{OUT} = 4.7\ \mu\text{F}$, $C_{IN} = 1\ \mu\text{F}$, all voltage options, ON/OFF pin tied to V_{IN} . (Continued)

Input to Output Leakage vs Temperature

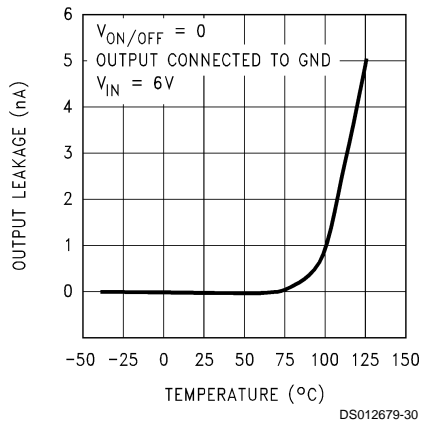

Output Reverse Leakage vs Temperature

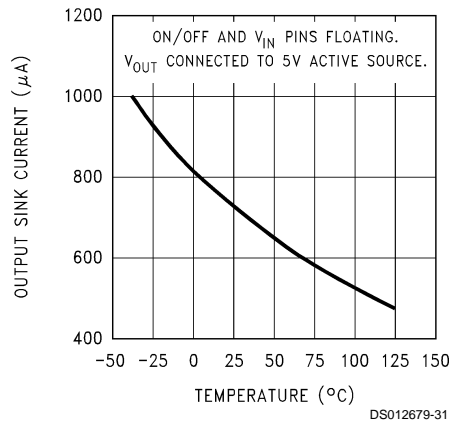

Output Noise Density

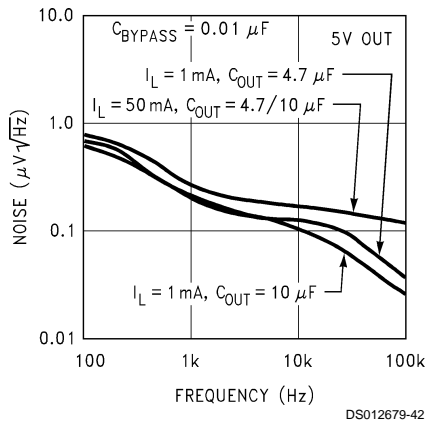

Output Noise Density

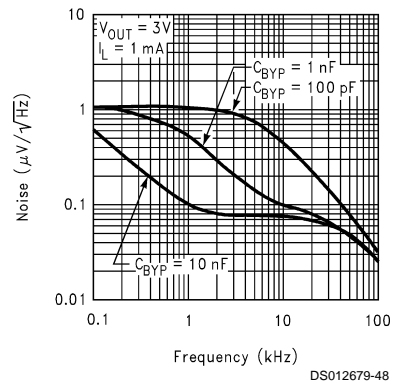

Output Noise Density

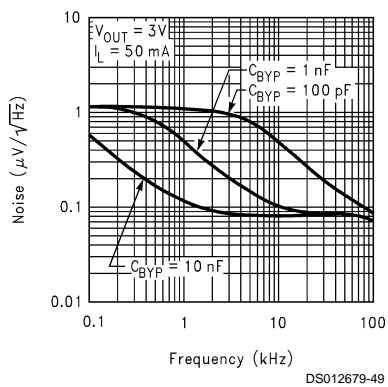

Ripple Rejection

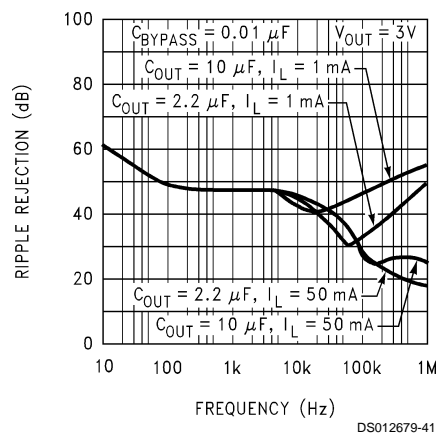

Typical Performance Characteristics Unless otherwise specified: $T_A = 25^\circ\text{C}$, $V_{IN} = V_{O(NOM)} + 1\text{V}$, $C_{OUT} = 4.7\ \mu\text{F}$, $C_{IN} = 1\ \mu\text{F}$, all voltage options, ON/OFF pin tied to V_{IN} . (Continued)

Turn-ON Waveform

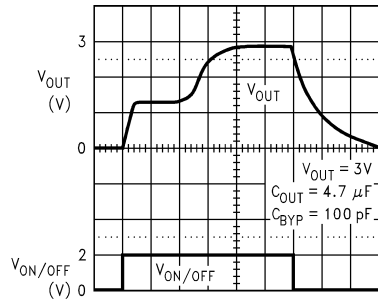

100 $\mu\text{s}/\text{Div}$

DS012679-50

Turn-ON Waveform

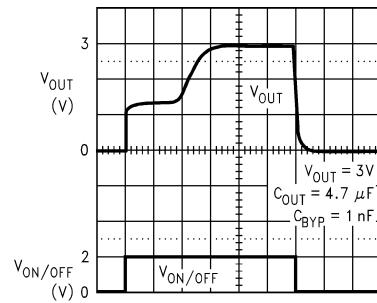

1 ms/Div

DS012679-51

Turn-ON Waveform

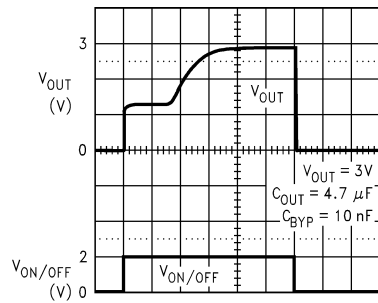

10 ms/Div

DS012679-52

Application Hints

EXTERNAL CAPACITORS

Like any low-dropout regulator, the external capacitors used with the LP2982 must be carefully selected to assure regulator loop stability.

INPUT CAPACITOR: An input capacitor whose value is $\geq 1 \mu\text{F}$ is required with the LP2982 (amount of capacitance can be increased without limit).

This capacitor must be located a distance of not more than 0.5" from the input pin of the LP2982 and returned to a clean analog ground. Any good quality ceramic or tantalum can be used for this capacitor.

OUTPUT CAPACITOR: The output capacitor must meet both the requirement for minimum amount of capacitance and E.S.R. (equivalent series resistance) value. Curves are provided which show the allowable ESR range as a function of load current for various output voltages and capacitor values (refer to *Figure 1*, *Figure 2*).

IMPORTANT: The output capacitor must maintain its ESR in the stable region over the full operating temperature to assure stability. Also, capacitor tolerance and variation with temperature must be considered to assure the minimum amount of capacitance is provided at all times.

This capacitor should be located not more than 0.5" from the output pin of the LP2982 and returned to a clean analog ground.

LOW-CURRENT OPERATION: In applications where the load current is $< 1 \text{ mA}$, special consideration must be given to the output capacitor.

Circuitry inside the LP2982 is specially designed to reduce operating (quiescent) current at light loads down to about 65 μA .

The mode of operation which yields this very low quiescent current also means that the output capacitor ESR is critical.

For optimum stability and minimum output noise, it is recommended that a 10 Ω resistor be placed in series with the output capacitor in any applications where $I_L < 1 \text{ mA}$.

CAPACITOR CHARACTERISTICS

TANTALUM: Tantalum capacitors are the best choice for use with the LP2982. Most good quality tantalum can be used with the LP2982, but check the manufacturer's data sheet to be sure the ESR is in range.

It is important to remember that ESR increases sharply at lower temperatures ($< 10^\circ\text{C}$) and a capacitor that is near the upper limit for stability at room temperature can cause instability when it gets cold.

In applications which must operate at very low temperatures, it may be necessary to parallel the output tantalum capacitor with a ceramic capacitor to prevent the ESR from going up too high (see next section for important information on ceramic capacitors).

CERAMIC: Ceramic capacitors are not recommended for use at the output of the LP2982. This is because the ESR of a ceramic can be low enough to go below the minimum stable value for the LP2982. A good 2.2 μF ceramic was measured and found to have an ESR of about 15 m Ω , which is low enough to cause oscillations.

If a ceramic capacitor is used on the output, a 1 Ω resistor should be placed in series with the capacitor.

ALUMINUM: Because of large physical size, aluminum electrolytic are not typically used with the LP2982. They must

meet the same ESR requirements over the operating temperature range, which is more difficult because of their large increase in ESR at cold temperature.

An aluminum electrolytic can exhibit an ESR increase of as much as 50X when going from 20°C to -40°C . Also, some aluminum electrolytic are not operational below -25°C because the electrolyte can freeze.

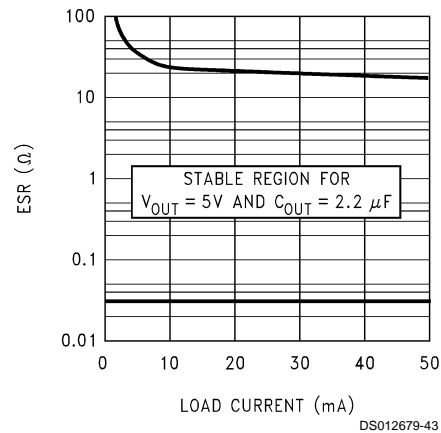

FIGURE 1. 5V/2.2 μF ESR Curves

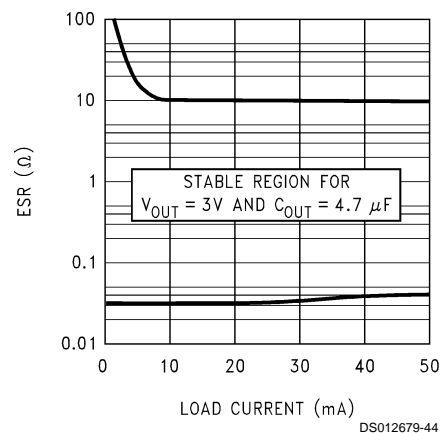

FIGURE 2. 3V/4.7 μF ESR Curves

BYPASS CAPACITOR

The 0.01 μF capacitor connected to the bypass pin to reduce noise must have very low leakage.

The current flowing out of the bypass pin comes from the bandgap reference, which is used to set the output voltage.

This capacitor leakage current causes the output voltage to decline by an amount proportional to the current. Typical values are $-0.015\%/n\text{A}$ @ -40°C , $-0.021\%/n\text{A}$ @ 25°C , and $-0.035\%/n\text{A}$ @ $+125^\circ\text{C}$.

This data is valid up to a maximum leakage current of about 500 nA, beyond which the bandgap is so severely loaded that it can not function.

Care must be taken to ensure that the capacitor selected will not have excessive leakage current over the operating temperature range of the application.

A high quality ceramic capacitor which uses either NPO or COG type dielectric material will typically have very low leakage. Small surface mount polypropylene or polycarbonate film capacitors also have extremely low leakage, but are slightly larger than ceramics.

Application Hints (Continued)

REVERSE CURRENT PATH

The power transistor used in the LP2982 has an inherent diode connected between the regulator input and output (see below).

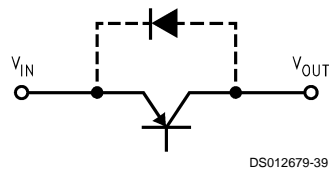

If the output is forced above the input by more than a V_{BE} , this diode will become forward biased and current will flow from the V_{OUT} terminal to V_{IN} . This current must be limited to < 100 mA to prevent damage to the part.

The internal diode can also be turned on by abruptly stepping the input voltage to a value below the output voltage.

To prevent regulator misoperation, a Schottky diode should be used in any application where input/output voltage conditions can cause the internal diode to be turned on (see below).

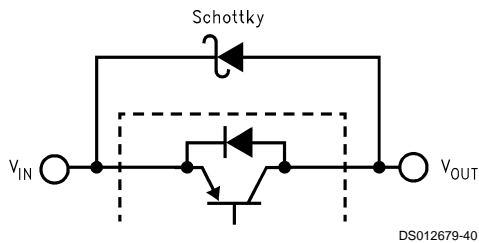

As shown, the Schottky diode is connected in parallel with the internal parasitic diode and prevents it from being turned on by limiting the voltage drop across it to about 0.3V.

ON/OFF INPUT OPERATION

The LP2982 is shut off by pulling the ON/OFF input low, and turned on by driving the input high. If this feature is not to be used, the ON/OFF input should be tied to V_{IN} to keep the regulator on at all times (the ON/OFF input must **not** be left floating).

To ensure proper operation, the signal source used to drive the ON/OFF input must be able to swing above and below the specified turn-on/turn-off voltage thresholds which guarantee an ON or OFF state (see Electrical Characteristics).

The ON/OFF signal may come from either a totem-pole output, or an open-collector output with pull-up resistor to the LP2982 input voltage or another logic supply. The high-level voltage may exceed the LP2982 input voltage, but must remain within the Absolute Maximum Ratings for the ON/OFF pin.

It is also important that the turn-on/turn-off voltage signals applied to the ON/OFF input have a slew rate which is greater than 40 mV/ μ s.

Important: the regulator shutdown function will operate incorrectly if a slow-moving signal is applied to the ON/OFF input.

Micro SMD Mounting

The micro SMD package requires specific mounting techniques which are detailed in National Semiconductor Application Note # 1112. Referring to the section **Surface Mount Technology (SMT) Assembly Considerations**, it should be noted that the pad style which must be used with the 5-pin package is the NSMD (non-solder mask defined) type.

For best results during assembly, alignment ordinals on the PC board may be used to facilitate placement of the micro SMD device.

Micro SMD Light Sensitivity

Exposing the micro SMD device to direct sunlight will cause misoperation of the device. Light sources such as Halogen lamps can also affect electrical performance if brought near to the device.

The wavelengths which have the most detrimental effect are reds and infra-reds, which means that the fluorescent lighting used inside most buildings has very little effect on performance. A micro SMD test board was brought to within 1 cm of a fluorescent desk lamp and the effect on the regulated output voltage was negligible, showing a deviation of less than 0.1% from nominal.

Physical Dimensions inches (millimeters) unless otherwise noted

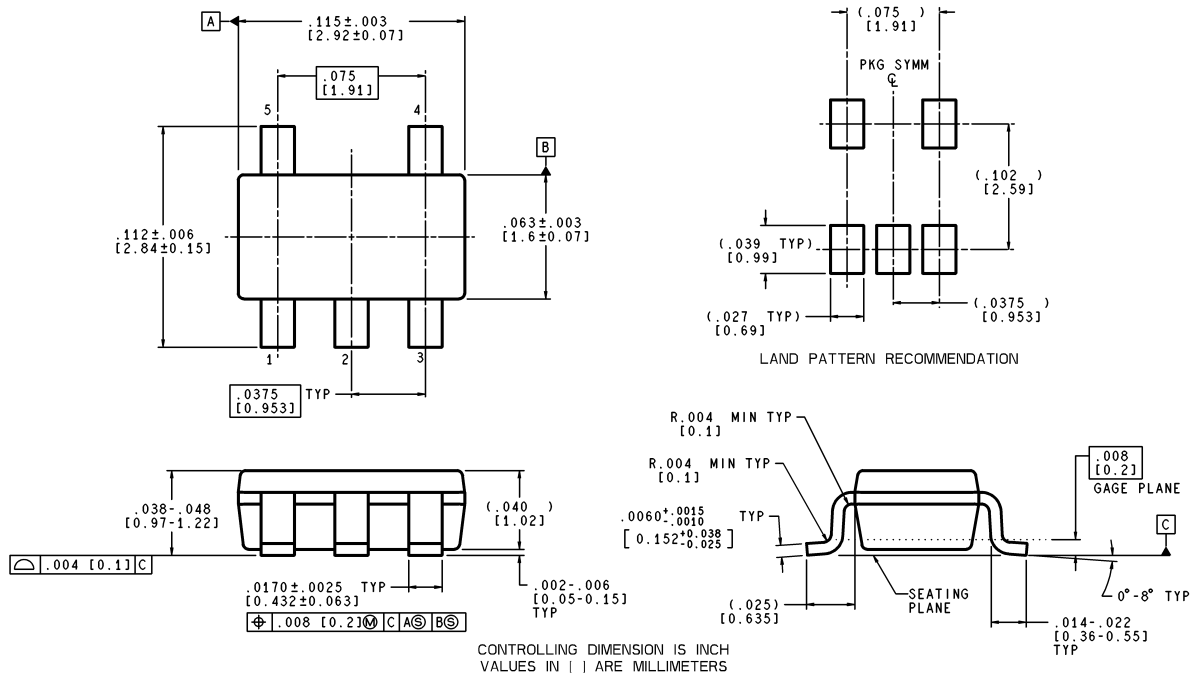

MF05A (Rev A)

**5-Lead Small Outline Package (M5)
NS Package Number MF05A**

For Order Numbers, refer to *Table 1* in the "Ordering Information" section of this document.

Physical Dimensions inches (millimeters) unless otherwise noted (Continued)

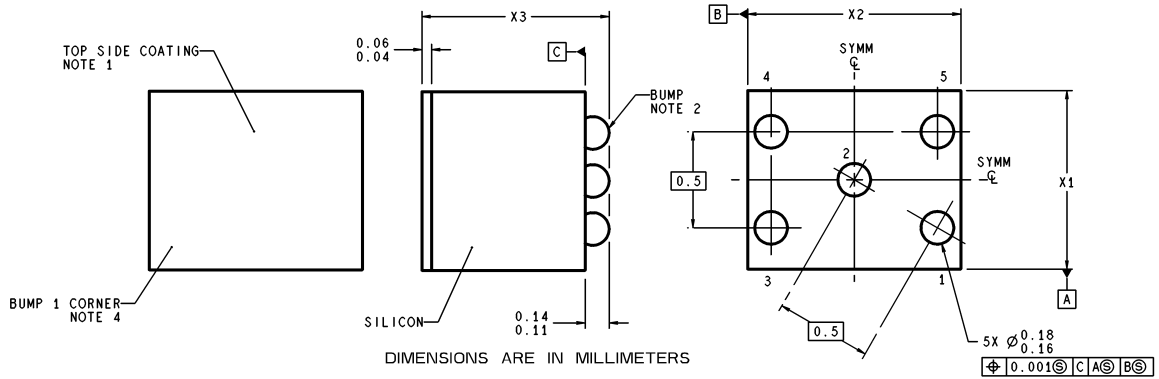
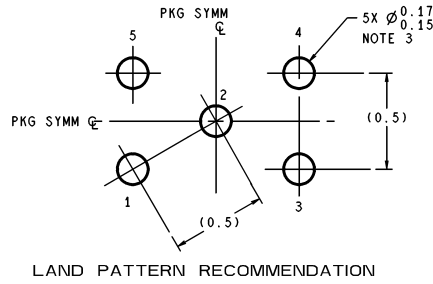

BPA05XXX (Rev A)

NOTES: UNLESS OTHERWISE SPECIFIED

1. EPOXY COATING
2. 63Sn/37Pb EUTECTIC BUMP
3. RECOMMEND NON-SOLDER MASK DEFINED LANDING PAD.
4. PIN 1 IS ESTABLISHED BY LOWER LEFT CORNER WITH RESPECT TO TEXT ORIENTATION. REMAINING PINS ARE NUMBERED COUNTER CLOCKWISE.
5. XXX IN DRAWING NUMBER REPRESENTS PACKAGE SIZE VARIATION WHERE X1 IS PACKAGE WIDTH, X2 IS PACKAGE LENGTH AND X3 IS PACKAGE HEIGHT.
6. NO JEDEC REGISTRATION AS OF AUG.1999.

**micro SMD, 5 Bump, Package (BPA05)
NS Package Number BPA05A**

For Order Numbers, refer to *Table 1* "Ordering Information" section of this document.

The dimensions for X1, X2 and X3 are as given:

- X1 = 0.930 +/- 0.030mm**
- X2 = 1.107 +/- 0.030mm**
- X3 = 0.850 +/- 0.050mm**

Notes

LIFE SUPPORT POLICY

NATIONAL'S PRODUCTS ARE NOT AUTHORIZED FOR USE AS CRITICAL COMPONENTS IN LIFE SUPPORT DEVICES OR SYSTEMS WITHOUT THE EXPRESS WRITTEN APPROVAL OF THE PRESIDENT AND GENERAL COUNSEL OF NATIONAL SEMICONDUCTOR CORPORATION. As used herein:

1. Life support devices or systems are devices or systems which, (a) are intended for surgical implant into the body, or (b) support or sustain life, and whose failure to perform when properly used in accordance with instructions for use provided in the labeling, can be reasonably expected to result in a significant injury to the user.
2. A critical component is any component of a life support device or system whose failure to perform can be reasonably expected to cause the failure of the life support device or system, or to affect its safety or effectiveness.



National Semiconductor Corporation
Americas
Tel: 1-800-272-9959
Fax: 1-800-737-7018
Email: support@nsc.com
www.national.com

National Semiconductor Europe
Fax: +49 (0) 180-530 85 86
Email: europe.support@nsc.com
Deutsch Tel: +49 (0) 69 9508 6208
English Tel: +44 (0) 870 24 0 2171
Français Tel: +33 (0) 1 41 91 8790

National Semiconductor Asia Pacific Customer Response Group
Tel: 65-2544466
Fax: 65-2504466
Email: ap.support@nsc.com

National Semiconductor Japan Ltd.
Tel: 81-3-5639-7560
Fax: 81-3-5639-7507