

MC33465

Advance Information

Micropower Undervoltage Sensing Circuits with Programmable Output Delay

The MC33465 series are micropower undervoltage sensing circuits that are specifically designed for use with battery powered microprocessor based systems, where extended battery life is required. A choice of several threshold voltages from 0.9 V to 4.5 V are available. This device features a very low quiescent bias current of 1.0 μ A typical.

The MC33465 series features a highly accurate voltage reference, a comparator with precise thresholds and built-in hysteresis to prevent erratic reset operation, a choice of output configurations between open drain or complementary, a time delayed output, which can be programmed by the system designer, and guaranteed operation below 1.0 V with extremely low standby current. This device is available in a SOT-23 5-pin surface mount package.

Applications include direct monitoring of the MPU/logic power supply used in appliance, automotive, industrial and portable equipment.

MC33465 Features:

- Extremely Low Standby Current of 1.0 μ A at $V_{in} = 3.5$ V
- Wide Input Voltage Range (0.7 V to 10 V)
- Monitors Power Supply Voltages from 1.1 V to 5.0 V
- High Accuracy Detector Threshold ($\pm 2.5\%$)
- Two Reset Output Types (Open Drain or Complementary Drive)
- Programmable Output Delay by External Capacitor (100 ms typ. with 0.15 μ F)
- Surface Mount Package (SOT-23 5-Pin)
- Convenient Tape and Reel (3000 per Reel)

MICROPOWER UNDervOLTAGE SENSING CIRCUITS WITH PROGRAMMABLE OUTPUT DELAY

SEMICONDUCTOR TECHNICAL DATA



N SUFFIX
PLASTIC PACKAGE
CASE 1212
(SOT-23)

ORDERING INFORMATION

Device	Threshold Voltage	Type	Operating Temperature Range	Package		
MC33465N-09ATR	0.9	Open Drain Reset	$T_A = -30^\circ$ to $+80^\circ\text{C}$	SOT-23		
MC33465N-20ATR	2.0					
MC33465N-27ATR	2.7					
MC33465N-30ATR	3.0					
MC33465N-45ATR	4.5					
MC33465N-09CTR	0.9	Compl. MOS Reset			$T_A = -30^\circ$ to $+80^\circ\text{C}$	SOT-23
MC33465N-20CTR	2.0					
MC33465N-27CTR	2.7					
MC33465N-30CTR	3.0					
MC33465N-45CTR	4.5					

Other voltages from 0.9 to 6.0 V, in 0.1 V increments, are available. Consult factory for information.

PIN CONNECTIONS

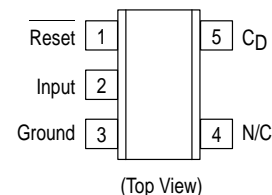

MC33465

Representative Block Diagrams

MC33465N-YYATR
Open Drain Output Configuration

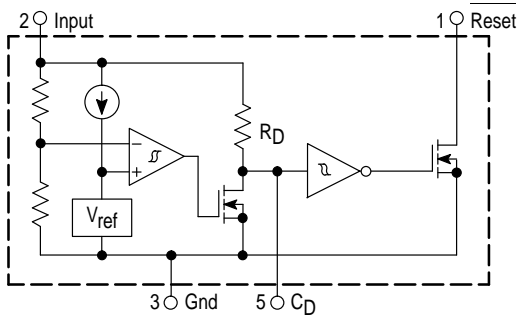

MC33465N-YYCTR
Complementary Output Configuration

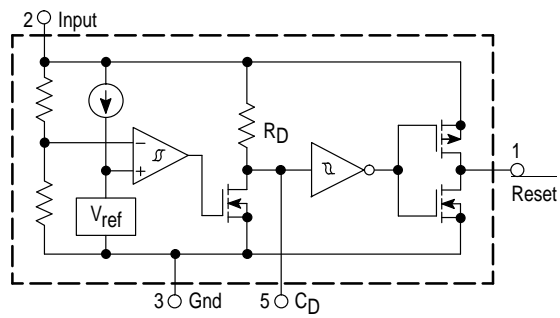

YY Denotes Threshold Voltage

This device contains 28 active transistors.

MAXIMUM RATINGS

Rating	Symbol	Value	Unit
Power Input Supply Voltage	V_{in}	0 to 12	V
Reset Output Voltage	V_O	-0.3 to 12	V
Reset Output Current (Source or Sink)	I_O	70	mA
Power Dissipation and Thermal Characteristics			
Maximum Power Dissipation at $T_A = 25^\circ\text{C}$	P_D	150	mW
Case 1212 (SOT-23) N Suffix			
Thermal Resistance, Junction-to-Ambient	$R_{\theta JA}$	667	$^\circ\text{C/W}$
Operating Junction Temperature	T_J	+125	$^\circ\text{C}$
Operating Ambient Temperature	T_A	-30 to +80	$^\circ\text{C}$
Storage Temperature Range	T_{stg}	-40 to +125	$^\circ\text{C}$
Lead Temperature (Soldering)	T_{solder}	260 $^\circ\text{C}$, 10 s	

MC33465

ELECTRICAL CHARACTERISTICS (For all values $T_A = 25^\circ\text{C}$ (Note 1), unless otherwise noted.)

Characteristic	Symbol	Min	Typ	Max	Unit
SENSE COMPARATOR					
Threshold Voltage High to Low State Output (V_{in} Decreasing) 09 Suffix 18 Suffix 27 Suffix 36 Suffix 45 Suffix	V_{IL}	0.878 1.755 2.633 3.51 4.387	0.9 1.8 2.7 3.6 4.5	0.922 1.845 2.767 3.69 4.612	V
Threshold Hysteresis (V_{in} Increasing) 09 Suffix 18 Suffix 27 Suffix 36 Suffix 45 Suffix	V_H	0.027 0.054 0.081 0.108 0.135	0.045 0.09 0.135 0.18 0.225	0.063 0.126 0.189 0.252 0.315	V
Threshold Voltage Temperature Coefficient	T_C	–	± 100	–	PPM/ $^\circ\text{C}$
RESET OUTPUT					
Output Voltage High State (Complementary Output: $I_{source} = 1.0\text{ mA}$) Low State (Complementary or Open Drain Output: $I_{sink} = 1.0\text{ mA}$)	V_{OH} V_{OL}	$V_{in} - 2.1$ –	$V_{in} - 1.0$ 0.25	V_{in} 0.5	V
Output Sink Current ($V_{in} = 1.5\text{ V}$, $V_{OL} = 0.5\text{ V}$)	I_{OL}	1.0	2.0	–	mA
Output Source Current ($V_{in} = 4.5\text{ V}$, $V_{OH} = 2.4\text{ V}$)	I_{OH}	1.0	2.0	–	mA
DELAY OUTPUT					
Output Sink Current ($V_{in} = 1.5\text{ V}$, $V_{OL} = 0.5\text{ V}$)	I_{OL}	0.2	0.8	–	mA
Delay Resistance	R_D	0.5	1.0	2.0	M Ω
TOTAL DEVICE					
Operating Input Voltage Range	V_{in}	0.8 to 10	–	–	V
Quiescent Input Current $V_{in} = 4.34\text{ V}$ $V_{in} = 6.50\text{ V}$	I_{in}	– –	5.5 1.3	11 3.9	μA

NOTE: 1. Low duty pulse techniques are used during test to maintain junction temperature as close to ambient as possible.

Figure 1. Reset Low State Sink Current versus Output Voltage

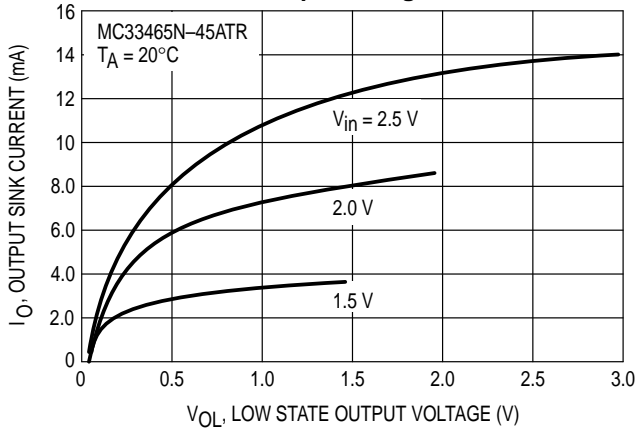

Figure 2. Output Voltage versus Input Voltage

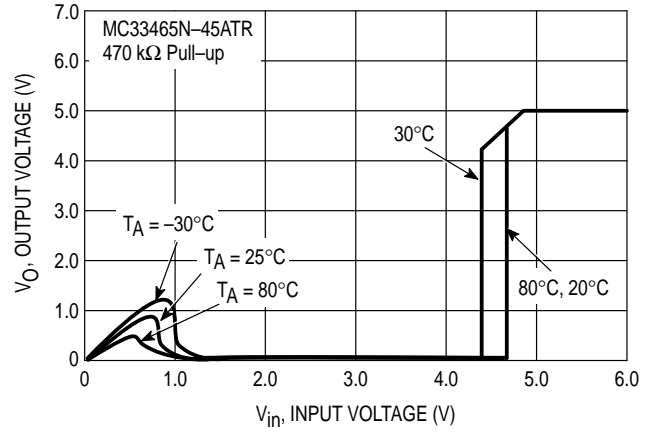

Figure 3. Input Current versus Input Voltage

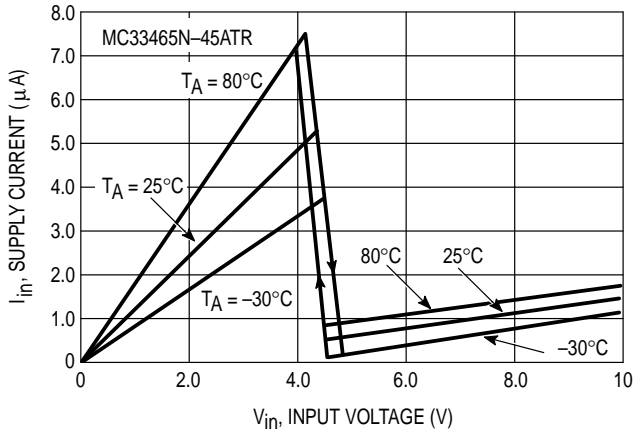

Figure 4. Comparator Input Threshold Voltage versus Temperature

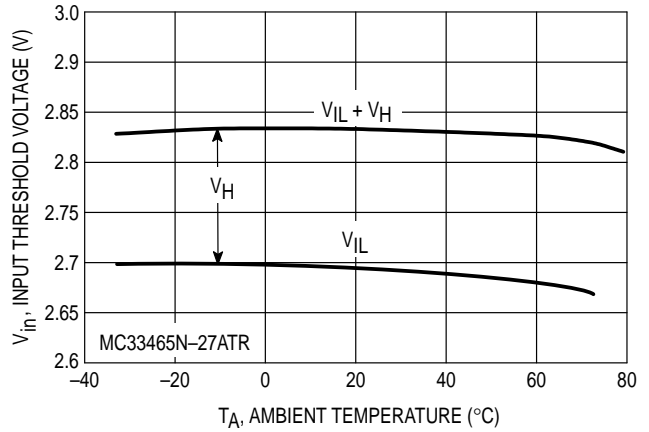

Figure 5. Reset Output Sink Current versus Input Voltage

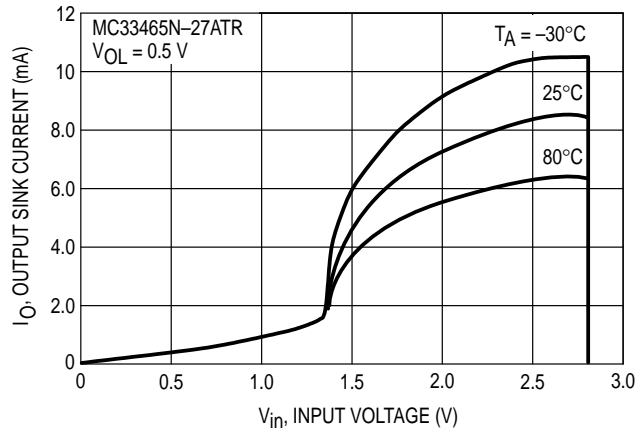

Figure 6. Reset Output Source Current versus Input Voltage

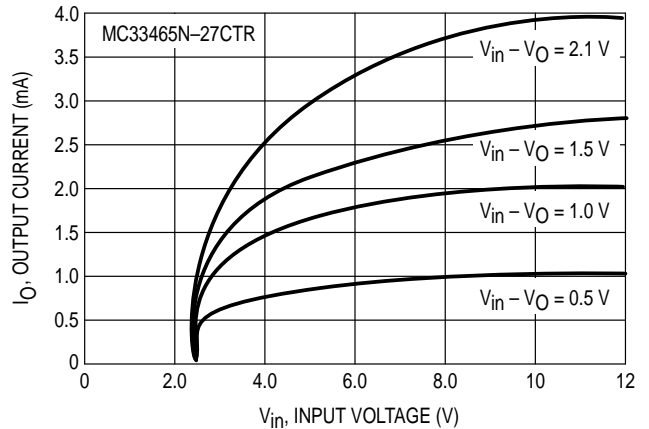

Figure 7. C_D Sink Current versus Input Voltage

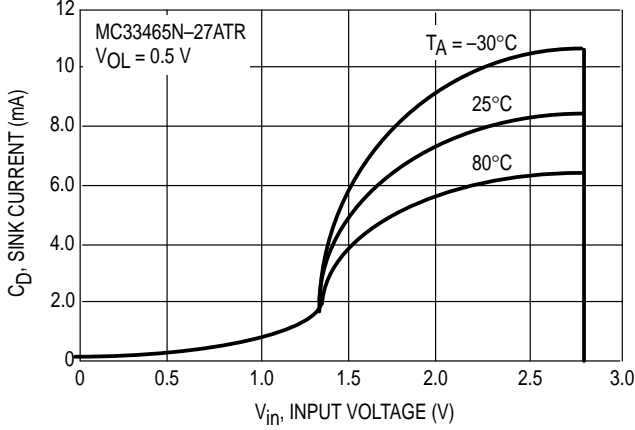

Figure 8. C_D Sink Current versus C_D Voltage

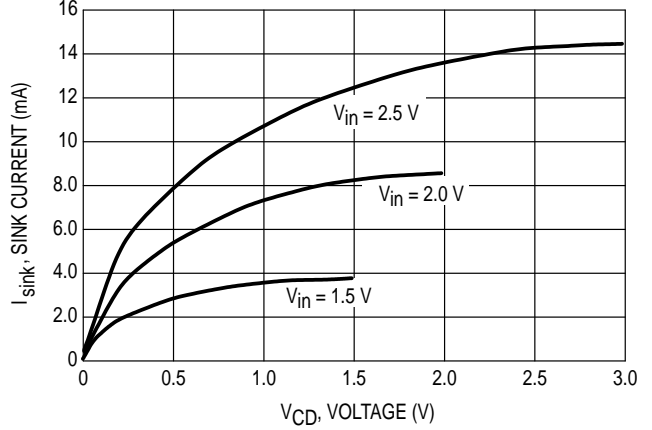

Figure 9. Delay Resistance versus Temperature

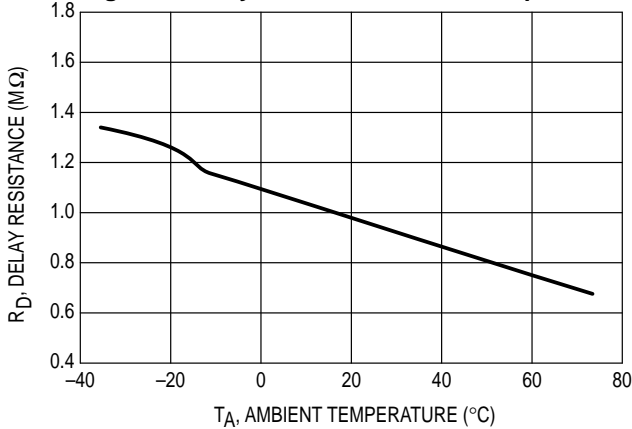

Figure 10. Detector Threshold versus Temperature

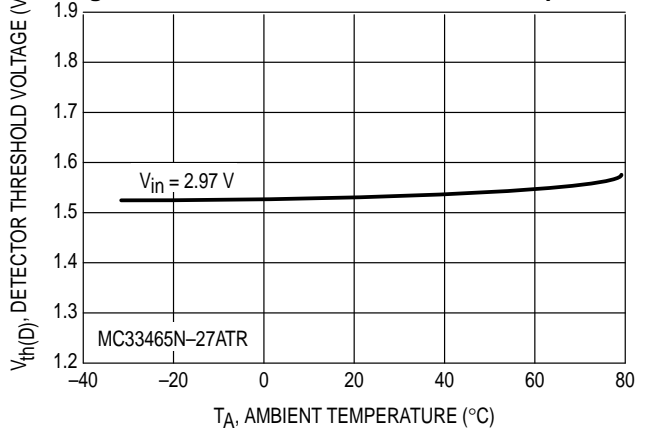
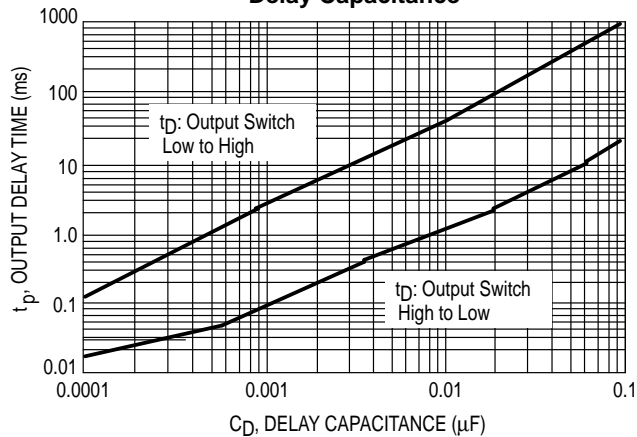

Figure 11. Output Delay Time versus Delay Capacitance



MC33465

Figure 12. Typical Open Drain Application

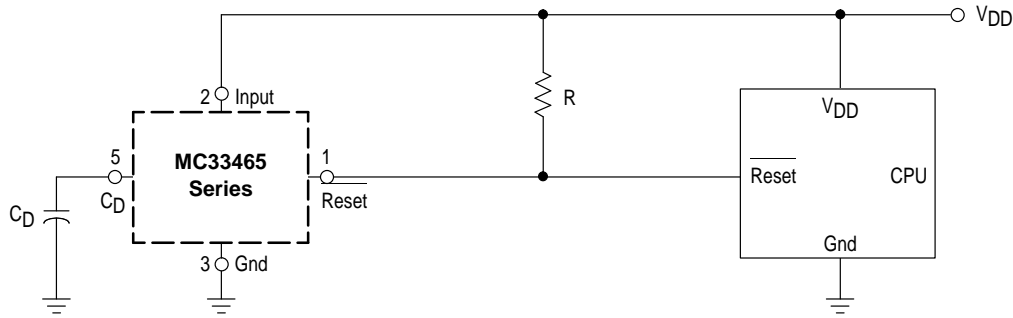
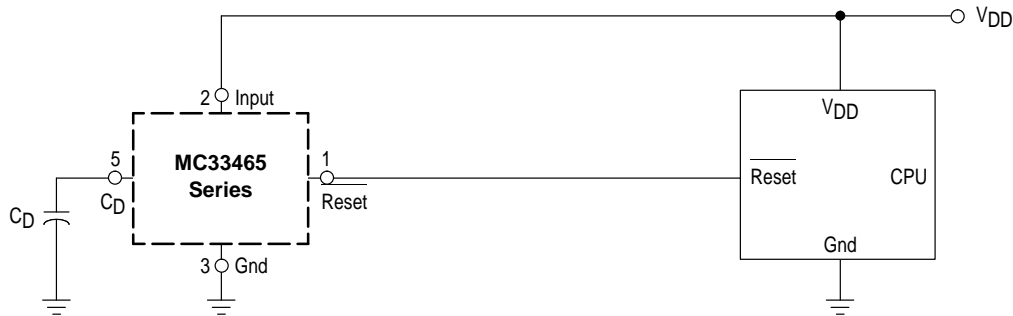

Figure 13. Typical Complementary Output Application



APPLICATION CIRCUIT INFORMATION

The MC33465 series are micropower undervoltage sensing circuits which offer a programmable time delayed output with the choice of either complementary output drive or open drain output configurations. Figure 14 shows the timing relationships between the input voltage and the resulting circuit waveforms. When the input voltage (V_{IN}) exceeds the sense comparator threshold, the timing capacitor is allowed to charge through the internal delay resistor. When the output inverting driver threshold is exceeded, the Reset output switches from a logic "0" to a

logic "1". The top curve of Figure 11 provides the nominal delay time for a given value of delay capacitance. When V_{IN} drops below the comparator threshold minus hysteresis voltage, the delay capacitor discharges. When the capacitance voltage drops below the inverting driver threshold, the output switches from a logic "1" to a logic "0". The bottom curve in Figure 11 provides typical delay time for given delay capacitance values. The inverting driver threshold voltage is typically about $V_{IN}/2$, as shown in Figure 10.

MC33465

Figure 14. Timing Waveforms

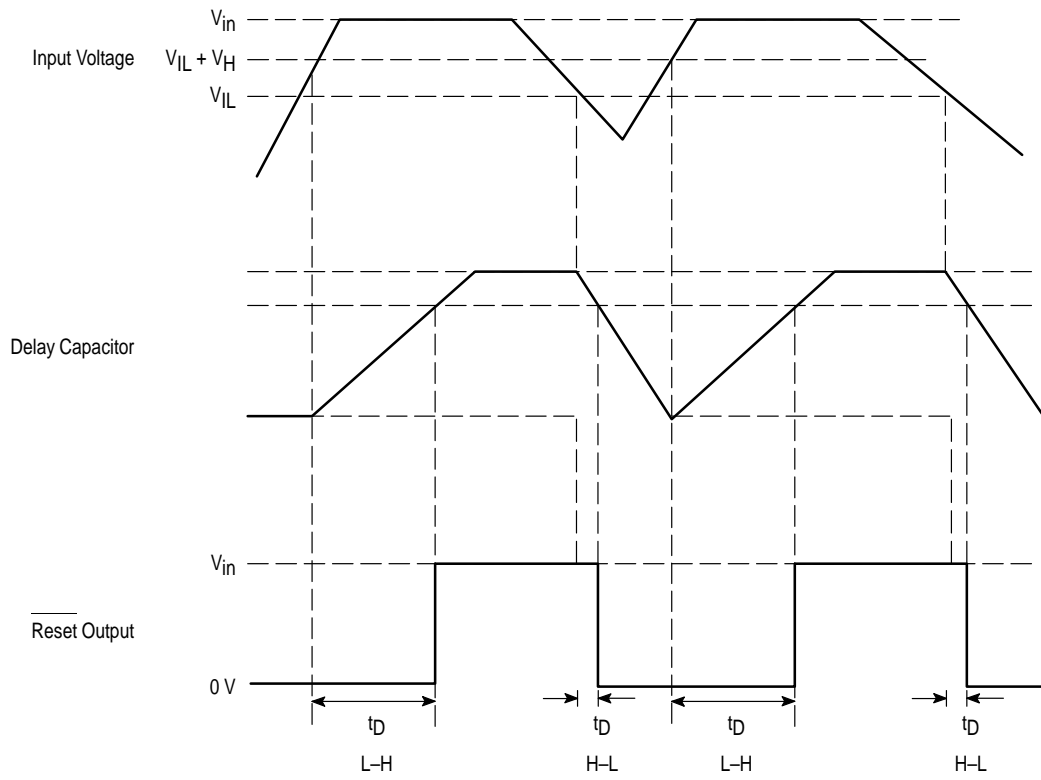

MC33465

OUTLINE DIMENSIONS

N SUFFIX
 PLASTIC PACKAGE
 CASE 1212-01
 (SOT-23)
 ISSUE O

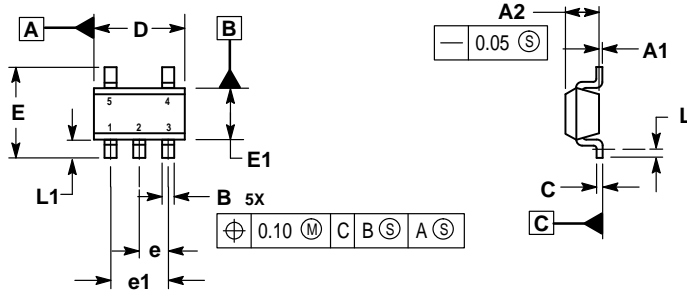

NOTES:

1. DIMENSIONS ARE IN MILLIMETERS.
2. INTERPRET DIMENSIONS AND TOLERANCES PER ASME Y14.5M, 1994.
3. DATUM C IS A SEATING PLANE.

MILLIMETERS		
DIM	MIN	MAX
A1	0.00	0.10
A2	1.00	1.30
B	0.30	0.50
C	0.10	0.25
D	2.80	3.00
E	2.50	3.10
E1	1.50	1.80
e	0.95 BSC	
e1	1.90 BSC	
L	0.20	—
L1	0.45	0.75

Motorola reserves the right to make changes without further notice to any products herein. Motorola makes no warranty, representation or guarantee regarding the suitability of its products for any particular purpose, nor does Motorola assume any liability arising out of the application or use of any product or circuit, and specifically disclaims any and all liability, including without limitation consequential or incidental damages. "Typical" parameters which may be provided in Motorola data sheets and/or specifications can and do vary in different applications and actual performance may vary over time. All operating parameters, including "Typicals" must be validated for each customer application by customer's technical experts. Motorola does not convey any license under its patent rights nor the rights of others. Motorola products are not designed, intended, or authorized for use as components in systems intended for surgical implant into the body, or other applications intended to support or sustain life, or for any other application in which the failure of the Motorola product could create a situation where personal injury or death may occur. Should Buyer purchase or use Motorola products for any such unintended or unauthorized application, Buyer shall indemnify and hold Motorola and its officers, employees, subsidiaries, affiliates, and distributors harmless against all claims, costs, damages, and expenses, and reasonable attorney fees arising out of, directly or indirectly, any claim of personal injury or death associated with such unintended or unauthorized use, even if such claim alleges that Motorola was negligent regarding the design or manufacture of the part. Motorola and are registered trademarks of Motorola, Inc. Motorola, Inc. is an Equal Opportunity/Affirmative Action Employer.

Mfax is a trademark of Motorola, Inc.

How to reach us:

USA/EUROPE/Locations Not Listed: Motorola Literature Distribution;
 P.O. Box 5405, Denver, Colorado 80217. 303-675-2140 or 1-800-441-2447

JAPAN: Nippon Motorola Ltd.; Tatsumi-SPD-JLDC, 6F Seibu-Butsuryu-Center,
 3-14-2 Tatsumi Koto-Ku, Tokyo 135, Japan. 81-3-3521-8315

Mfax™: RMFAX0@email.sps.mot.com – TOUCHTONE 602-244-6609
INTERNET: http://Design-NET.com

ASIA/PACIFIC: Motorola Semiconductors H.K. Ltd.; 8B Tai Ping Industrial Park,
 51 Ting Kok Road, Tai Po, N.T., Hong Kong. 852-26629298



MC33465/D