

LOW VOLTAGE, 1:15 DIFFERENTIAL ECL/PECL CLOCK DIVIDER AND FANOUT BUFFER

MC100ES6222

The MC100ES6222 is a bipolar monolithic differential clock fanout buffer. Designed for most demanding clock distribution systems, the MC100ES6222 supports various applications that require the distribution of precisely aligned differential clock signals. Using SiGe technology and a fully differential architecture, the device offers very low skew outputs and superior digital signal characteristics. Target applications for this clock driver is high performance clock distribution in computing, networking and telecommunication systems.

Features

- 15 differential ECL/PECL outputs (4 output banks)
- 2 selectable differential ECL/PECL inputs
- Selectable $\div 1$ or $\div 2$ frequency divider
- 130 ps maximum device skew
- Supports DC to 3 GHz input frequency
- Single 3.3 V, -3.3 V, 2.5 V or -2.5 V supply
- Standard 52-lead LQFP package with exposed pad for enhanced thermal characteristics
- Supports industrial temperature range
- Pin and function compatible to the MC100EP222
- 52-lead Pb-free Package Available

Functional Description

The MC100ES6222 is designed for low skew clock distribution systems and supports clock frequencies up to 3 GHz. The CLK0 and CLK1 inputs can be driven by ECL or PECL compatible signals. Each of the four output banks of two, three, four and six differential clock output pairs can be independently configured to distribute the input frequency or $\div 2$ of the input frequency. The FSELA, FSELB, FSELC, FSELD, and CLK_SEL are asynchronous control inputs. Any changes of the control inputs require a MR pulse for resynchronization of the $\div 2$ outputs. For the functionality of the MR control input, see [Figure 5. Functional Diagram](#).

In order to meet the tight skew specification of the device, both outputs of a differential output pair should be terminated, even if only one output is used. In the case where not all ten outputs are used, the output pairs on the same package side as the parts being used on that side should be terminated.

The MC100ES6222 can be operated from a single 3.3 V or 2.5 V supply. As most other ECL compatible devices, the MC100ES6222 supports positive (PECL) and negative (ECL) supplies. The MC100ES6222 is pin and function compatible to the MC100EP222.

**LOW-VOLTAGE 1:15 DIFFERENTIAL
ECL/PECL CLOCK DIVIDER
AND FANOUT DRIVER**

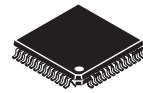

**TB SUFFIX
52-LEAD LQFP PACKAGE
EXPOSED PAD
CASE 1336A-01**

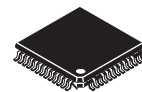

**AE SUFFIX
52-LEAD LQFP PACKAGE
EXPOSED PAD
Pb-FREE PACKAGE
CASE 1336A-01**

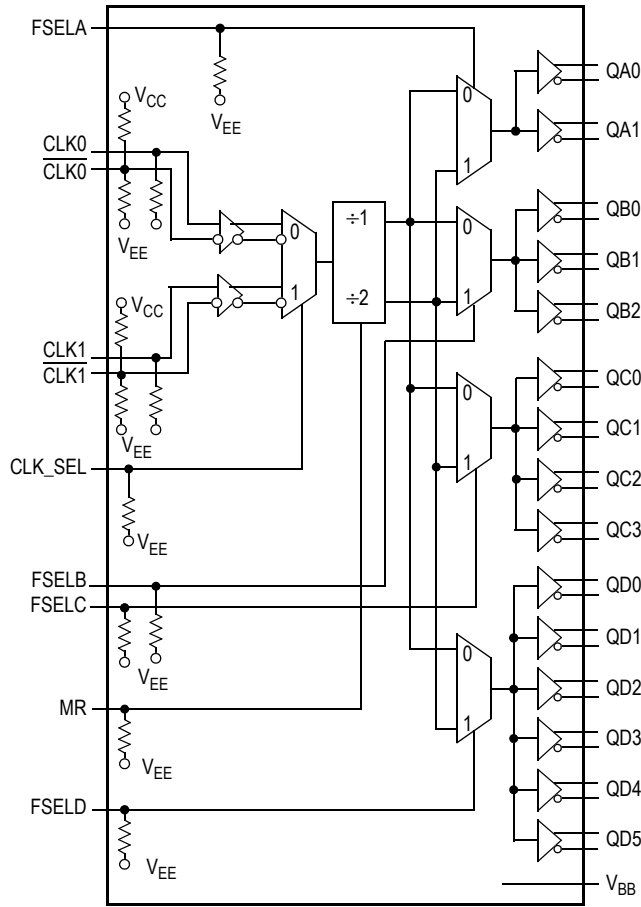

Figure 1. MC100ES6222 Logic Diagram

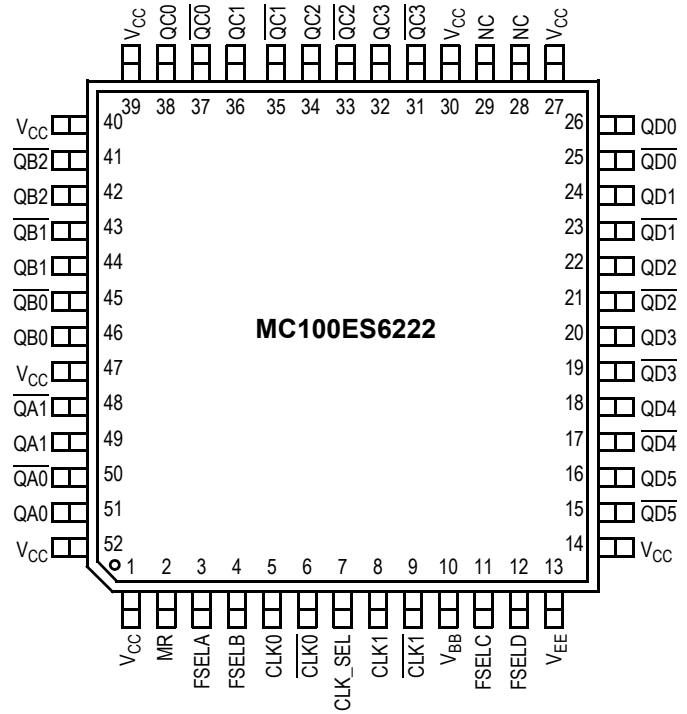

Figure 2. 52-Lead Package Pinout (Top View)

Table 1. Function Table

Control Pin	0	1
FSELA (asynchronous)	÷1	÷2
FSELB (asynchronous)	÷1	÷2
FSELB (asynchronous)	÷1	÷2
FSELB (asynchronous)	÷1	÷2
CLK_SEL (asynchronous)	CLK0	CLK1
MR (asynchronous)	Active	Reset. Q _X = L and Q̄ _X = H.

Table 2. Pin Configurations

Pin	I/O	Type	Description
CLK0, $\overline{\text{CLK0}}$	Input	ECL/PECL	Differential reference clock signal input
CLK1, $\overline{\text{CLK1}}$	Input	ECL/PECL	Alternative differential reference clock signal input
FSELA, FSELB, FSELC, FSELD	Input	ECL/PECL	Selection output frequency divider for bank A, B, C and D
MR	Input	ECL/PECL	Reset
CLK_SEL	Input	ECL/PECL	Clock reference select input
QA[0:1], $\overline{\text{QA}}[0:1]$	Output	ECL/PECL	Bank A differential outputs
QB[0:2], $\overline{\text{QB}}[0:2]$	Output	ECL/PECL	Bank B differential outputs
QC[0:3], $\overline{\text{QC}}[0:3]$	Output	ECL/PECL	Bank C differential outputs
QD[0:5], $\overline{\text{QD}}[0:5]$	Output	ECL/PECL	Bank D differential outputs
V _{BB}	Output	DC	Reference voltage output for single ended ECL or PECL operation
V _{EE} ⁽¹⁾		Power supply	Negative power supply
V _{CC}		Power supply	Positive power supply. All V _{CC} pins must be connected to the positive power supply for correct DC and AC operation.

1. In ECL mode (negative power supply mode), V_{EE} is either -3.3 V or -2.5 V and V_{CC} is connected to GND (0 V). In PECL mode (positive power supply mode), V_{EE} is connected to GND (0 V) and V_{CC} is either +3.3 V or +2.5 V. In both modes, the input and output levels are referenced to the most positive supply (V_{CC}).

Table 3. Absolute Maximum Ratings⁽¹⁾

Symbol	Characteristics	Min	Max	Unit	Condition
V _{CC}	Supply Voltage	-0.3	3.6	V	
V _{IN}	DC Input Voltage	-0.3	V _{CC} + 0.3	V	
V _{OUT}	DC Output Voltage	-0.3	V _{CC} + 0.3	V	
I _{IN}	DC Input Current		±20	mA	
I _{OUT}	DC Output Current		±50	mA	
T _S	Storage Temperature	-65	125	°C	
T _{FUNC}	Functional Temperature Range	T _A = -40	T _J = +110	°C	

1. Absolute maximum continuous ratings are those maximum values beyond which damage to the device may occur. Exposure to these conditions or conditions beyond those indicated may adversely affect device reliability. Functional operation at absolute-maximum-rated conditions is not implied.

Table 4. General Specifications

Symbol	Characteristics	Min	Typ	Max	Unit	Condition
V_{TT}	Output Termination Voltage		$V_{CC} - 2^{(1)}$		V	
MM	ESD Protection (Machine Model)	175			V	
HBM	ESD Protection (Human Body Model)	4000			V	
CDM	ESD Protection (Charged Device Model)	2000			V	
LU	Latch-Up Immunity	200			mA	
C_{IN}	Input Capacitance		4.0		pF	Inputs
θ_{JA}, θ_{JC} θ_{JB}	Thermal Resistance (junction-to-ambient, junction-to-board, junction-to-case)	See Table 9. Thermal Resistance			°C/W	
T_J	Operating Junction Temperature ⁽²⁾ (continuous operation) MTBF = 9.1 years	0		110	°C	

- Output termination voltage $V_{TT} = 0$ V for $V_{CC} = 2.5$ V operation is supported but the power consumption of the device will increase.
- Operating junction temperature impacts device life time. Maximum continuous operating junction temperature should be selected according to the application life time requirements (See application note AN1545 for more information). The device AC and DC parameters are specified up to 110°C junction temperature allowing the MC100ES6222 to be used in applications requiring industrial temperature range. It is recommended that users of the MC100ES6222 employ thermal modeling analysis to assist in applying the junction temperature specifications to their particular application.

Table 5. PECL DC Characteristics ($V_{CC} = 2.5$ V \pm 5% or $V_{CC} = 3.3$ V \pm 5%, $V_{EE} = \text{GND}$, $T_J = 0^\circ\text{C}$ to $+110^\circ\text{C}$)

Symbol	Characteristics	Min	Typ	Max	Unit	Condition
Clock Input Pair CLK0, $\overline{\text{CLK0}}$, CLK1, $\overline{\text{CLK1}}$ (PECL differential signals)						
V_{PP}	Differential Input Voltage ⁽¹⁾	0.1		1.3	V	Differential operation
V_{CMR}	Differential Cross Point Voltage ⁽²⁾	1.0		$V_{CC} - 0.3$	V	Differential operation
I_{IN}	Input Current ⁽¹⁾			± 150	μA	$V_{IN} = V_{IL}$ or $V_{IN} = V_{IH}$
Clock Inputs MR, CLK_SEL, FSELA, FSELB, FSELC, FSELD (PECL single ended signals)						
V_{IH}	Input Voltage High	$V_{CC} - 1.165$		$V_{CC} - 0.880$	V	
V_{IL}	Input Voltage Low	$V_{CC} - 1.810$		$V_{CC} - 1.475$	V	
I_{IN}	Input Current ⁽³⁾			± 150	μA	$V_{IN} = V_{IL}$ or $V_{IN} = V_{IH}$
PECL Clock Outputs (QA[0:1], $\overline{\text{QA}}[0:1]$, QB[0:2], $\overline{\text{QB}}[0:2]$, QC[0:3], $\overline{\text{QC}}[0:3]$, QD[0:5], $\overline{\text{QD}}[0:5]$						
V_{OH}	Output High Voltage	$V_{CC} - 1.1$	$V_{CC} - 1.005$	$V_{CC} - 0.7$	V	$I_{OH} = -30$ mA ⁽⁴⁾
V_{OL}	Output Low Voltage	$V_{CC} - 1.9$	$V_{CC} - 1.705$	$V_{CC} - 1.4$	V	$I_{OL} = -5$ mA ⁽⁴⁾
Supply Current and V_{BB}						
$I_{EE}^{(5)}$	Maximum Quiescent Supply Current without Output Termination Current		96	170	mA	V_{EE} pins
V_{BB}	Output Reference Voltage	$V_{CC} - 1.38$		$V_{CC} - 1.22$	V	$I_{BB} = 0.4$ mA

- V_{PP} (DC) is the minimum differential input voltage swing required to maintain device functionality.
- V_{CMR} (DC) is the crosspoint of the differential input signal. Functional operation is obtained when the crosspoint is within the V_{CMR} (DC) range and the input swing lies within the V_{PP} (DC) specification.
- Input have internal pullup/pulldown resistors which affect the input current.
- Equivalent to a termination of 50 Ω to V_{TT} .
- I_{CC} calculation: $I_{CC} = (\text{number of differential output used}) \times (I_{OH} + I_{OL}) + I_{EE}$
 $I_{CC} = (\text{number of differential output used}) \times (V_{OH} - V_{TT}) \div R_{load} + (V_{OL} - V_{TT}) \div R_{load} + I_{EE}$.

Table 6. ECL DC Characteristics ($V_{EE} = -2.5\text{ V} \pm 5\%$ or $V_{EE} = -3.3\text{ V} \pm 5\%$, $V_{CC} = \text{GND}$, $T_J = 0^\circ\text{C}$ to $+110^\circ\text{C}$)

Symbol	Characteristics	Min	Typ	Max	Unit	Condition
Clock Input Pair CLK0, $\overline{\text{CLK0}}$, CLK1, $\overline{\text{CLK1}}$ (ECL differential signals)						
V_{PP}	Differential Input Voltage ⁽¹⁾	0.1		1.3	V	Differential operation
V_{CMR}	Differential Cross Point Voltage ⁽²⁾	$V_{EE} + 1.0$		-0.3	V	Differential operation
I_{IN}	Input Current ⁽¹⁾			± 150	μA	$V_{IN} = V_{IL}$ or $V_{IN} = V_{IH}$
Clock Inputs MR, CLK_SEL, FSELA, FSELB, FSELC, FSELD (PECL single ended signals)						
V_{IH}	Input Voltage High	-1.165		-0.880	V	
V_{IL}	Input Voltage Low	-1.810		-1.475	V	
I_{IN}	Input Current ⁽³⁾			± 150	μA	$V_{IN} = V_{IL}$ or $V_{IN} = V_{IH}$
ECL Clock Outputs (QA[0:1], $\overline{\text{QA}}$ [0:1], QB[0:2], $\overline{\text{QB}}$ [0:2], QC[0:3], $\overline{\text{QC}}$ [0:3], QD[0:5], $\overline{\text{QD}}$ [0:5])						
V_{OH}	Output High Voltage	-1.1	-1.005	-0.7	V	$I_{OH} = -30\text{ mA}^{(4)}$
V_{OL}	Output Low Voltage	-1.9	-1.705	1.4	V	$I_{OL} = -5\text{ mA}^{(4)}$
Supply Current and V_{BB}						
$I_{EE}^{(5)}$	Maximum Quiescent Supply Current without Output Termination Current		96	170	mA	V_{EE} pins
V_{BB}	Output Reference Voltage	-1.38		-1.22	V	$I_{BB} = 0.4\text{ mA}$

1. V_{PP} (DC) is the minimum differential input voltage swing required to maintain device functionality.

2. V_{CMR} (DC) is the crosspoint of the differential input signal. Functional operation is obtained when the crosspoint is within the V_{CMR} (DC) range and the input swing lies within the V_{PP} (DC) specification.

3. Input have internal pullup/pulldown resistors which affect the input current.

4. Equivalent to a termination of $50\ \Omega$ to V_{TT} .

5. I_{CC} calculation: $I_{CC} = (\text{number of differential output used}) \times (I_{OH} + I_{OL}) + I_{EE}$
 $I_{CC} = (\text{number of differential output used}) \times (V_{OH} - V_{TT}) \div R_{load} + (V_{OL} - V_{TT}) \div R_{load} + I_{EE}$.

Table 7. AC Characteristics (ECL: $V_{EE} = -3.3 \text{ V} \pm 5\%$ or $V_{EE} = -2.5 \text{ V} \pm 5\%$, $V_{CC} = \text{GND}$) or
(PECL: $V_{CC} = 3.3 \text{ V} \pm 5\%$ or $V_{CC} = 2.5 \text{ V} \pm 5\%$, $V_{EE} = \text{GND}$, $T_J = 0^\circ\text{C}$ to $+110^\circ\text{C}$)⁽¹⁾

Symbol	Characteristics	Min	Typ	Max	Unit	Condition	
Clock Input Pair CLK0, $\overline{\text{CLK0}}$, CLK1, $\overline{\text{CLK1}}$ (PECL or ECL differential signals)							
V_{PP}	Differential Input Voltage ⁽²⁾ (peak-to-peak)	0.2		1.3	V		
V_{CMR}	Differential Input Crosspoint Voltage ⁽³⁾	PECL ECL 1.0 $V_{EE}+1.0$		$V_{CC}-0.3$ -0.3 V	V V		
f_{CLK}	Input Frequency	0		2000	MHz	Differential	
ECL/PECL Clock Outputs (QA[0:1], $\overline{\text{QA}}$ [0:1], QB[0:2], $\overline{\text{QB}}$ [0:2], QC[0:3], $\overline{\text{QC}}$ [0:3], QD[0:5], $\overline{\text{QD}}$ [0:5])							
t_{PD}	Propagation Delay	CLK0 or CLK1 to Qx MR to Qx	670 820	970	ps ps	Differential	
$V_{O(P-P)}$	Differential Output Voltage (peak-to-peak)	$f_O < 1.0 \text{ GHz}$ $f_O < 2.0 \text{ GHz}$	TBD TBD		mV mV		
$t_{sk(O)}$	Output-to-Output Skew	within QA[0:1] within QB[0:2] within QC[0:3] within QD[0:5] any output		35 35 50 60 130	ps ps ps ps ps	Differential	
$t_{sk(PP)}$	Output-to-Output Skew (part-to-part)			300	ps	Differential	
$t_{JIT(CC)}$	Output Cycle-to-Cycle Jitter	RMS (1σ)		1	ps		
$t_{SK(P)}$	Output Pulse Skew ⁽⁴⁾		5	15	ps		
DC_O	Output Duty Cycle	$f_{REF} < 0.1 \text{ GHz}$ $f_{REF} < 1.0 \text{ GHz}$ $f_{REF} < 2.0 \text{ GHz}$	49.85 48.50 47.00	50 50 50	50.15 51.50 53.00	% % %	$DC_{REF} = 50\%$ $DC_{REF} = 50\%$ $DC_{REF} = 50\%$
t_r, t_f	Output Rise/Fall Time		50	300	ps	20% to 80%	

- AC characteristics apply for parallel output termination of 50Ω to V_{TT} .
- V_{PP} (AC) is the minimum differential ECL/PECL input voltage swing required to maintain AC characteristics including t_{pd} and device-to-device skew.
- V_{CMR} (AC) is the crosspoint of the differential ECL/PECL input signal. Normal AC operation is obtained when the crosspoint is within the V_{CMR} (AC) range and the input swing lies within the V_{PP} (AC) specification. Violation of V_{CMR} (AC) or V_{PP} (AC) impacts the device propagation delay, device and part-to-part skew.
- Output pulse skew is the absolute difference of the propagation delay times: $|t_{pLH} - t_{pHL}|$.

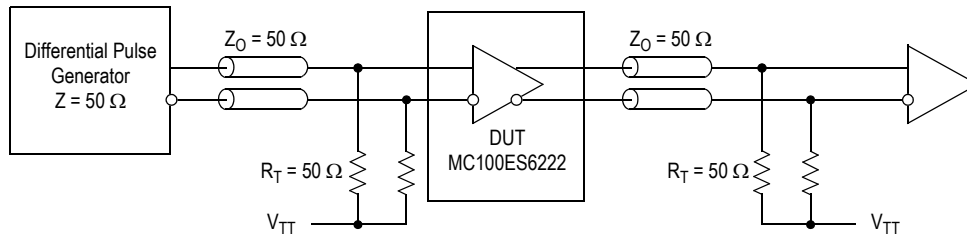

Figure 3. MC100ES6222 AC Test Reference

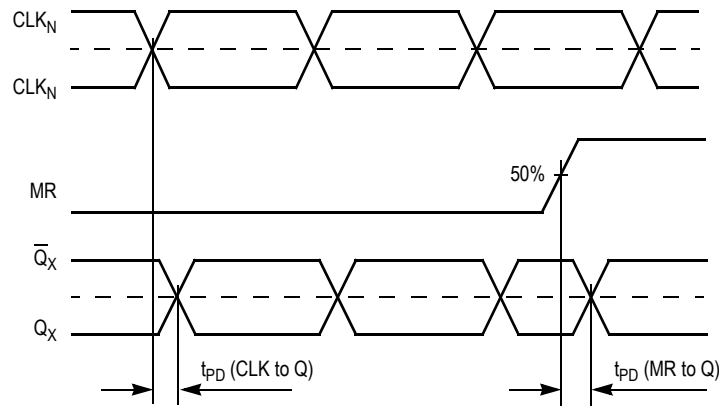

Figure 4. MC100ES6222 t_{PD} Measurement Waveform

APPLICATIONS INFORMATION

Asynchronous Reset Functional Diagram

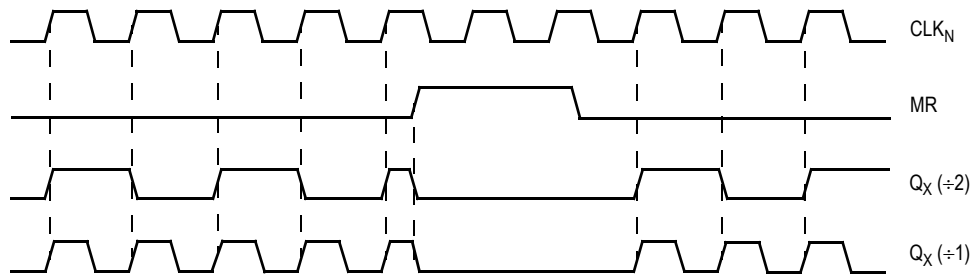

Figure 5. Functional Diagram

APPLICATIONS INFORMATION

Understanding the Junction Temperature Range of the MC100ES6222

To make the optimum use of high clock frequency and low skew capabilities of the MC100ES6222, the MC100ES6222 is specified, characterized and tested for the junction temperature range of $T_J = 0^\circ\text{C}$ to $+110^\circ\text{C}$. Because the exact thermal performance depends on the PCB type, design, thermal management and natural or forced air convection, the junction temperature provides an exact way to correlate the application specific conditions to the published performance data of this data sheet. The correlation of the junction temperature range to the application ambient temperature range and vice versa can be done by calculation:

$$T_J = T_A + R_{thja} \cdot P_{tot}$$

Assuming a thermal resistance (junction to ambient) of $17^\circ\text{C}/\text{W}$ (2s2p board, 200 ft/min airflow, see [Table 9. Thermal Resistance](#)) and a typical power consumption of 1026 mW (all outputs terminated 50 ohms to V_{TT} , $V_{CC} = 3.3\text{ V}$, frequency independent), the junction temperature of the MC100ES6222 is approximately $T_A + 17^\circ\text{C}$, and the minimum ambient temperature in this example case calculates to -17°C (the maximum ambient temperature is 93°C , see [Table 8](#)). Exceeding the minimum junction temperature specification of the MC100ES6222 does not have a significant impact on the device functionality. However, the continuous use the MC100ES6222 at high ambient temperatures requires thermal management to not exceed the specified maximum junction temperature. Please see the application note AN1545 for a power consumption calculation guideline.

Table 8. Ambient Temperature Ranges ($P_{tot} = 1026\text{ mW}$)

R_{thja} (2s2p board)		T_A , Min ⁽¹⁾	T_A , Max
Natural convection	$20^\circ\text{C}/\text{W}$	-21°C	89°C
100 ft/min	$18^\circ\text{C}/\text{W}$	-18°C	92°C
200 ft/min	$17^\circ\text{C}/\text{W}$	-17°C	93°C
400 ft/min	$16^\circ\text{C}/\text{W}$	-16°C	94°C
800 ft/min	$15^\circ\text{C}/\text{W}$	-15°C	95°C

- The MC100ES6222 device function is guaranteed from $T_A = -40^\circ\text{C}$ to $T_J = 110^\circ\text{C}$.

Maintaining Lowest Device Skew

The MC100ES6222 guarantees low output-to-output bank skew of 130 ps and a part-to-part skew of max. 300 ps. To ensure low skew clock signals in the application, both outputs of any differential output pair need to be terminated identically, even if only one output is used. When fewer than all nine output pairs are used, identical termination of all output pairs within the output bank is recommended. This will reduce the device power consumption while maintaining minimum output skew.

Power Supply Bypassing

The MC100ES6222 is a mixed analog/digital product. The differential architecture of the MC100ES6222 supports low noise signal operation at high frequencies. In order to maintain its superior signal quality, all V_{CC} pins should be bypassed by high-frequency ceramic capacitors connected to GND. If the spectral frequencies of the internally generated switching noise on the supply pins cross the series resonant point of an individual bypass capacitor, its overall impedance begins to look inductive and thus increases with increasing frequency. The parallel capacitor combination shown ensures that a low impedance path to ground exists for frequencies well above the noise bandwidth.

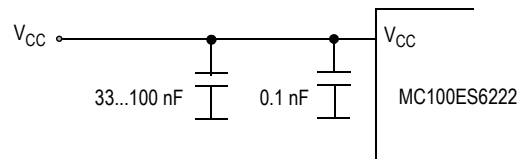
**Figure 6. V_{CC} Power Supply Bypass**

APPLICATIONS INFORMATION

Using the Thermally Enhanced Package of the MC100ES6222

The MC100ES6222 uses a thermally enhanced exposed pad (EP) 52 lead LQFP package. The package is molded so the lead frame is exposed at the surface of the package bottom side. The exposed metal pad will provide the low thermal impedance supporting the power consumption of the MC100ES6222 high-speed bipolar integrated circuit and eases the power management task for the system design. A thermal land pattern on the printed circuit board and thermal vias are recommended in order to take advantage of the enhanced thermal capabilities of the MC100ES6222. Direct soldering of the exposed pad to the thermal land will provide an efficient thermal path. In multilayer board designs, thermal vias thermally connect the exposed pad to internal copper planes. Number of vias, spacing, via diameters and land pattern design depend on the application and the amount of heat to be removed from the package. A nine thermal via array, arranged in a 3 x 3 array and using a 1.2 mm pitch in the center of the thermal land is a requirement for MC100ES6222 applications on multi-layer boards. The recommended thermal land design comprises a 3 x 3 thermal via array as illustrated in Figure 7. Recommended Thermal Land Pattern, providing an efficient heat removal path.

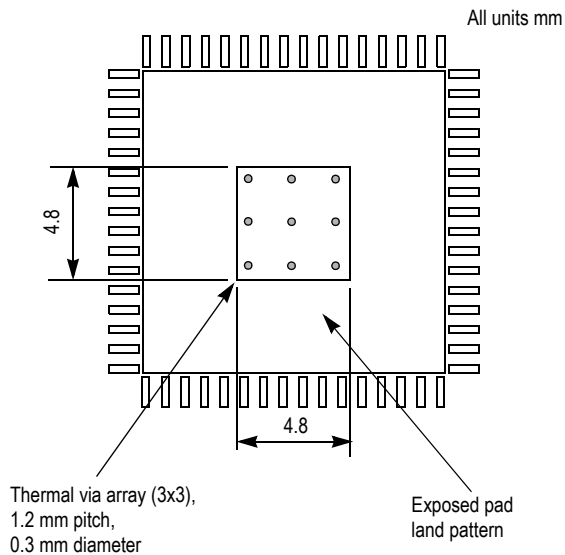

Figure 7. Recommended Thermal Land Pattern

The via diameter is should be approximately 0.3 mm with 1 ounce copper via barrel plating. Solder wicking inside the via resulting in voids during the solder process must be avoided. If the copper plating does not plug the vias, stencil print solder paste onto the printed circuit pad. This will supply enough solder paste to fill those vias and not starve the solder joints. The attachment process for exposed pad package is equivalent to standard surface mount packages. Figure 8. Recommended Solder Mask Openings illustrates a recommend solder mask opening with respect to the

recommended 3 x 3 thermal via array. Because a large solder mask opening may result in a poor release, the opening should be subdivided as illustrated in Figure 8. Recommended Solder Mask Openings. For the nominal package standoff 0.1 mm, a stencil thickness of 5 to 8 mils should be considered.

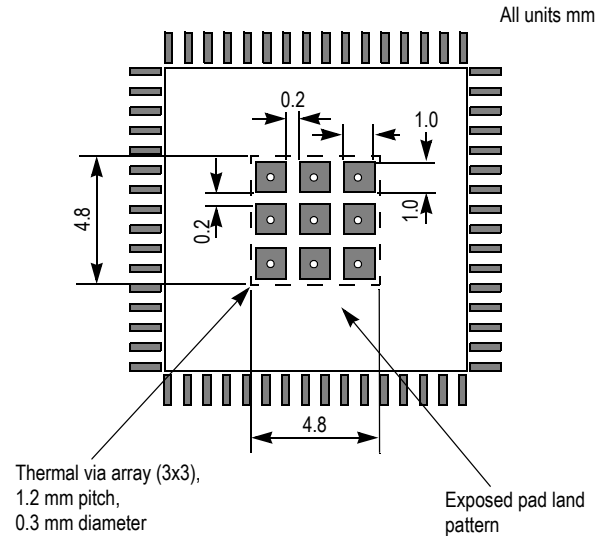

Figure 8. Recommended Solder Mask Openings

For thermal system analysis and junction temperature calculation the thermal resistance parameters of the package is provided:

Table 9. Thermal Resistance⁽¹⁾

Convection LPM	$R_{THJA}^{(2)}$ °C/W	$R_{THJA}^{(3)}$ °C/W	R_{THJC} °C/W	$R_{THJB}^{(4)}$ °C/W
Natural	20	48	4 ⁽⁵⁾ 29 ⁽⁶⁾	16
100	18	47		
200	17	46		
400	16	43		
800	15	41		

1. Applicable for a 3 x 3 thermal via array
2. Junction to ambient, four conductor layer test board (2S2P), per JES51-7 and JESD 51-5
3. Junction to ambient, single layer test board, per JESD51-3
4. Junction to board, four conductor layer test board (2S2P) per JESD 51-8
5. Junction to exposed pad
6. Junction to top of package

It is recommended to employ thermal modeling analysis to assist in applying the general recommendations to their particular application. The exposed pad of the MC100ES6222 package does not have an electrical low impedance path to the substrate of the integrated circuit and its terminals. The thermal land should be connected to GND through connection of internal board layers.

PACKAGE DIMENSIONS

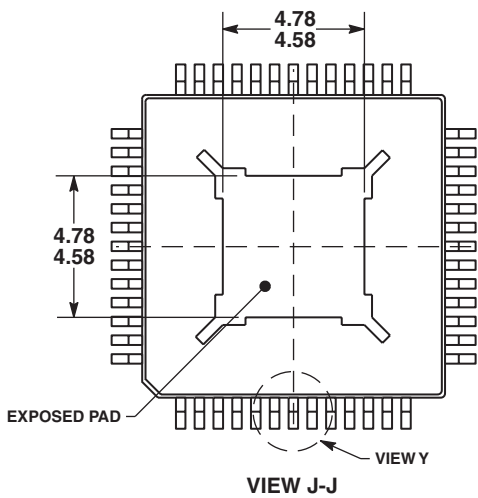
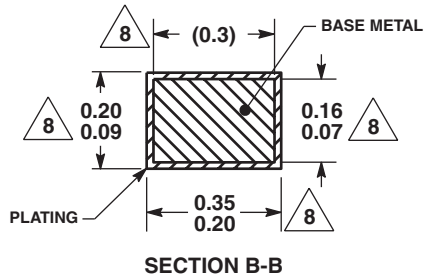
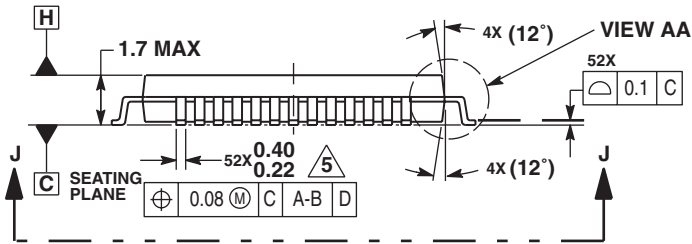
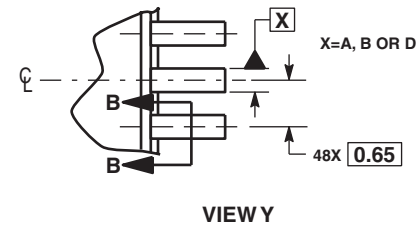
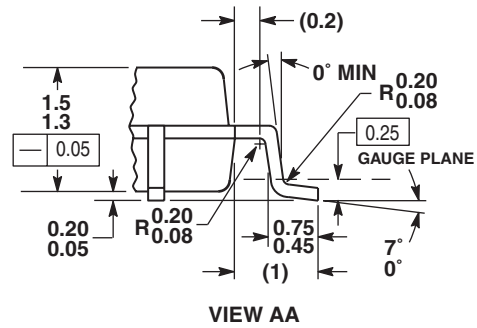
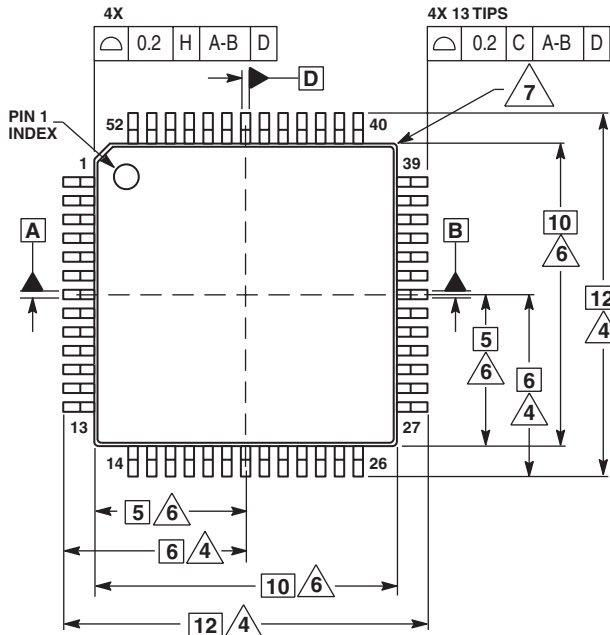

- NOTES:
1. DIMENSIONS ARE IN MILLIMETERS.
 2. INTERPRET DIMENSIONS AND TOLERANCES PER ASME Y14.5M, 1994.
 3. DATUMS A, B AND D TO BE DETERMINED AT DATUM PLANE H.
 4. DIMENSION TO BE DETERMINED AT SEATING PLANE C.
 5. THIS DIMENSION DOES NOT INCLUDE DAMBAR PROTRUSION. ALLOWABLE DAMBAR PROTRUSION SHALL NOT CAUSE THE LEAD WIDTH TO EXCEED 0.46 mm. DAMBAR CANNOT BE LOCATED ON THE LOWER RADIUS OR THE FOOT. MINIMUM SPACE BETWEEN PROTRUSION AND ADJACENT LEAD SHALL NOT BE LESS THAN 0.07 mm.
 6. THIS DIMENSION DOES NOT INCLUDE MOLD PROTRUSION. ALLOWABLE PROTRUSION IS 0.25mm PER SIDE. THIS DIMENSION IS MAXIMUM PLSTIC BODY SIZE DIMENSION INCLUDING MOLD MISMATCH. EXACT SHAPE OF EACH CORNER IS OPTIONAL.
 8. THESE DIMENSIONS APPLY TO THE FLAT SECTION OF THE LEAD BETWEEN 0.10mm AND 0.25mm FROM THE LEAD TIP.

CASE 1336A-01
ISSUE O
52-LEAD LQFP PACKAGE

MC100ES6222

LOW VOLTAGE, 1:15 DIFFERENTIAL, ECL/PECL CLOCK DIVIDER AND FANOUT BUFFER

Innovate with IDT and accelerate your future networks. Contact:

www.IDT.com

For Sales

800-345-7015
408-284-8200
Fax: 408-284-2775

For Tech Support

netcom@idt.com
480-763-2056

Corporate Headquarters

Integrated Device Technology, Inc.
6024 Silver Creek Valley Road
San Jose, CA 95138
United States
800 345 7015
+408 284 8200 (outside U.S.)

Asia

Integrated Device Technology
IDT (S) Pte. Ltd.
1 Kallang Sector, #07-01/06
Kolam Ayer Industrial Park
Singapore 349276
+65 67443356
Fax: +65 67441764

Japan

NIPPON IDT KK
Sanbancho Tokyu, Bld. 7F,
8-1 Sanbancho
Chiyoda-ku, Tokyo 102-0075
+81 3 3221 9822
Fax: +81 3 3221 9824

Europe

IDT Europe, Limited
321 Kingston Road
Leatherhead, Surrey
KT22 7TU
England
+44 (0) 1372 363 339
Fax: +44 (0) 1372 37885
idteurope@idt.com



© 2008 Integrated Device Technology, Inc. All rights reserved. Product specifications subject to change without notice. IDT and the IDT logo are trademarks of Integrated Device Technology, Inc. Accelerated Thinking is a service mark of Integrated Device Technology, Inc. All other brands, product names and marks are or may be trademarks or registered trademarks used to identify products or services of their respective owners.
Printed in USA