



2.5V PROGRAMMABLE SKEW PLL CLOCK DRIVER TURBOCLOCK™ II

IDT5T995/A

FEATURES:

- Ref input is 3.3V tolerant
- 4 pairs of programmable skew outputs
- Low skew: 185ps same pair, 250ps all outputs
- Selectable positive or negative edge synchronization:
Excellent for DSP applications
- Synchronous output enable
- Input frequency:
 - Std: 2MHz to 160MHz
 - A: 2MHz to 200MHz
- Output frequency:
 - Std: 6MHz to 160MHz
 - A: 6MHz to 200MHz
- 3-level inputs for skew and PLL range control
- 3-level inputs for feedback divide selection multiply / divide ratios of (1-6, 8, 10, 12) / (2, 4)
- PLL bypass for DC testing
- External feedback, internal loop filter
- 12mA balanced drive outputs
- Low Jitter: <100ps cycle-to-cycle
- Power-down mode
- Lock indicator
- Standard and A speed grades
- Available in TQFP package

DESCRIPTION:

The IDT5T995 is a high fanout 2.5V PLL based clock driver intended for high performance computing and data-communications applications. A key feature of the programmable skew is the ability of outputs to lead or lag the REF input signal. The IDT5T995 has eight programmable skew outputs in four banks of 2. Skew is controlled by 3-level input signals that may be hard-wired to appropriate high-mid-low levels.

The feedback input allows divide-by-functionality from 1 to 12 through the use of the DS[1:0] inputs. This provides the user with frequency multiplication from 1 to 12 without using divided outputs for feedback.

When the $\overline{\text{sOE}}$ pin is held low, all the outputs are synchronously enabled. However, if $\overline{\text{sOE}}$ is held high, all the outputs except 2Q0 and 2Q1 are synchronously disabled. The LOCK output asserts to indicate when Phase Lock has been achieved.

Furthermore, when PE is held high, all the outputs are synchronized with the positive edge of the REF clock input. When PE is held low, all the outputs are synchronized with the negative edge of REF. The IDT5T995 has LVTTTL outputs with 12mA balanced drive outputs.

FUNCTIONAL BLOCK DIAGRAM

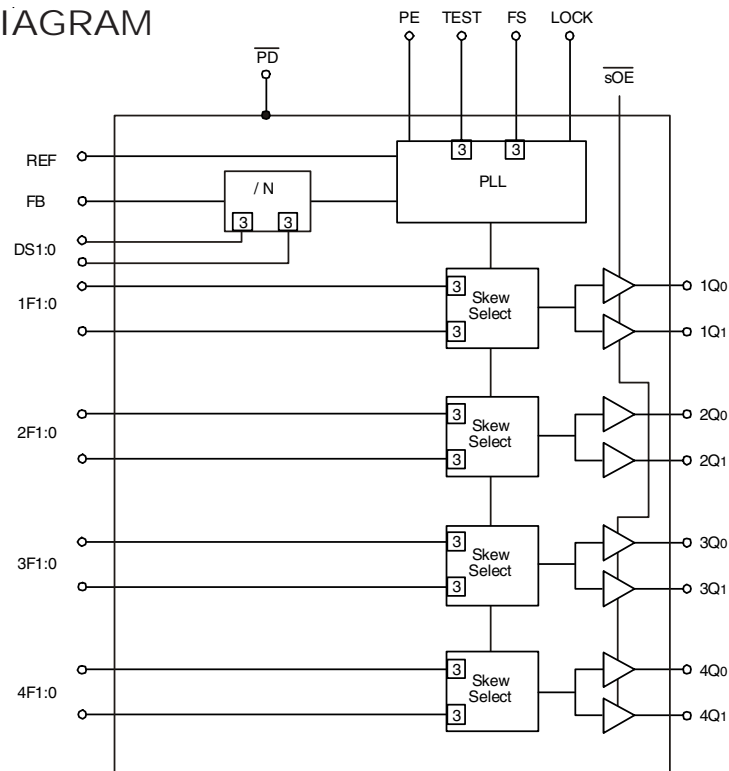

The IDT logo is a registered trademark of Integrated Device Technology, Inc.

INDUSTRIAL TEMPERATURE RANGE

DECEMBER 2006

PIN CONFIGURATION

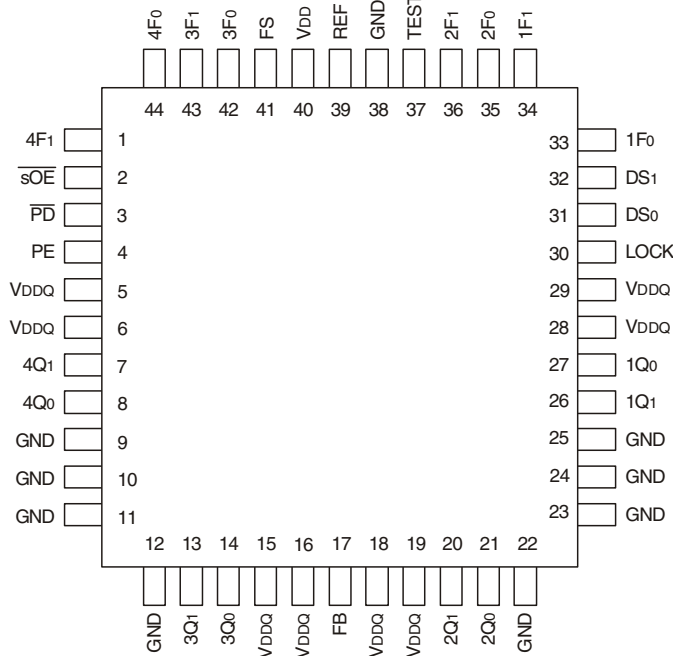

TQFP
TOP VIEW

ABSOLUTE MAXIMUM RATINGS⁽¹⁾

Symbol	Description	Max	Unit	
V _{DDQ} , V _{DD}	Supply Voltage to Ground	-0.5 to +4.6	V	
V _I	DC Input Voltage	-0.5 to V _{DD} +0.5	V	
	REF Input Voltage	-0.5 to +4.6	V	
	Maximum Power Dissipation	T _A = 85°C T _A = 55°C	0.7 1.1	W
T _{STG}	Storage Temperature Range	-65 to +150	°C	

NOTE:

- Stresses beyond those listed under ABSOLUTE MAXIMUM RATINGS may cause permanent damage to the device. These are stress ratings only, and functional operation of the device at these or any other conditions above those indicated in the operational sections of this specification is not implied. Exposure to absolute-maximum-rated conditions for extended periods may affect device reliability.

CAPACITANCE (T_A = +25°C, f = 1MHz, V_{IN} = 0V)

Parameter	Description	Typ.	Max.	Unit
C _{IN}	Input Capacitance	5	7	pF

NOTE:

- Capacitance applies to all inputs except TEST, FS, nF[1:0], and DS[1:0].

PIN DESCRIPTION

Pin Name	Type	Description
REF	IN	Reference Clock Input
FB	IN	Feedback Input
TEST ⁽¹⁾	IN	When MID or HIGH, disables PLL (except for conditions of Note 1). REF goes to all outputs. Skew Selections (See Control Summary Table) remain in effect. Set LOW for normal operation.
sOE ⁽¹⁾	IN	Synchronous Output Enable. When HIGH, it stops clock outputs (except 2Q0 and 2Q1) in a LOW state (for PE = H) - 2Q0 and 2Q1 may be used as the feedback signal to maintain phase lock. When TEST is held at MID level and sOE is HIGH, the nF[1:0] pins act as output disable controls for individual banks when nF[1:0] = LL. Set sOE LOW for normal operation (has internal pull-down).
PE	IN	Selectable positive or negative edge control. When LOW/HIGH the outputs are synchronized with the negative/positive edge of the reference clock (has internal pull-up).
nF[1:0]	IN	3-level inputs for selecting 1 of 9 skew taps or frequency functions
FS	IN	Selects appropriate oscillator circuit based on anticipated frequency range. (See Programmable Skew Range.)
nQ[1:0]	OUT	Four banks of two outputs with programmable skew
DS[1:0]	IN	3-level inputs for feedback divider selection
PD	IN	Power down control. Shuts off entire chip when LOW (has internal pull-up).
LOCK	OUT	PLL lock indication signal. HIGH indicates lock. LOW indicates that the PLL is not locked and outputs may not be synchronized to the inputs. (For more information on application specific use of the LOCK pin, please see AN237.)
V _{DDQ}	PWR	Power supply for output buffers
V _{DD}	PWR	Power supply for phase locked loop, lock output, and other internal circuitry
GND	PWR	Ground

NOTE:

- When TEST = MID and sOE = HIGH, PLL remains active with nF[1:0] = LL functioning as an output disable control for individual output banks. Skew selections remain in effect unless nF[1:0] = LL.

PROGRAMMABLE SKEW

Output skew with respect to the REF input is adjustable to compensate for PCB trace delays, backplane propagation delays or to accommodate requirements for special timing relationships between clocked components. Skew is selectable as a multiple of a time unit (tu) which ranges from 782ps to 1.5625ns for Standard version and 6.25ps to 1.3ns for A version (see Programmable Skew Range and Resolution Table). There are nine skew configurations available for each output pair. These con-

figurations are chosen by the nF_{1:0} control pins. In order to minimize the number of control pins, 3-level inputs (HIGH-MID-LOW) are used, they are intended for but not restricted to hard-wiring. Undriven 3-level inputs default to the MID level. Where programmable skew is not a requirement, the control pins can be left open for the zero skew default setting. The Control Summary Table shows how to select specific skew taps by using the nF_{1:0} control pins.

EXTERNAL FEEDBACK

By providing external feedback, the IDT5T995 gives users flexibility with regard to skew adjustment. The FB signal is compared with the input REF signal at the phase detector in order to drive the VCO. Phase differences cause the VCO of the PLL to adjust upwards or downwards accordingly.

An internal loop filter moderates the response of the VCO to the phase detector. The loop filter transfer function has been chosen to provide minimal jitter (or frequency variation) while still providing accurate responses to input frequency changes.

PROGRAMMABLE SKEW RANGE AND RESOLUTION TABLE

	IDT5T995			IDT5T995A			Comments
	FS = LOW	FS = MID	FS = HIGH	FS = LOW	FS = MID	FS = HIGH	
Timing Unit Calculation (tu)	1/(32 x FNOM)	1/(16 x FNOM)	1/(8 x FNOM)	1/(32 x FNOM)	1/(16 x FNOM)	1/(8 x FNOM)	
VCO Frequency Range (FNOM) ^(1,2)	24 to 40MHz	40 to 80MHz	80 to 160MHz	24 to 50MHz	48 to 100MHz	96 to 200MHz	
Skew Adjustment Range ⁽³⁾							
Max Adjustment:	±7.8125ns	±9.375ns	±9.375ns	±7.8125ns	±7.8125ns	±7.8125ns	ns
	±67.5°	±135°	±270°	±67.5°	±135°	±270°	Phase Degrees
	±18.75%	±37.5%	±75%	±18.75%	±37.5%	±75%	% of Cycle Time
Example 1, FNOM = 25MHz	tu = 1.25ns	—	—	tu = 1.25ns	—	—	
Example 2, FNOM = 37.5MHz	tu = 0.833ns	—	—	tu = 0.833ns	—	—	
Example 3, FNOM = 50MHz	—	tu = 1.25ns	—	tu = 0.625ns	tu = 1.25ns	—	
Example 4, FNOM = 75MHz	—	tu = 0.833ns	—	—	tu = 0.833ns	—	
Example 5, FNOM = 100MHz	—	—	tu = 1.25ns	—	tu = 0.625ns	tu = 1.25ns	
Example 6, FNOM = 150MHz	—	—	tu = 0.833ns	—	—	tu = 0.833ns	
Example 7, FNOM = 200MHz	—	—	—	—	—	tu = 0.625ns	

NOTES:

- The device may be operated outside recommended frequency ranges without damage, but functional operation is not guaranteed.
- The level to be set on FS is determined by the nominal operating frequency of the VCO and Time Unit Generator. The VCO frequency always appears at 1Q_{1:0}, 2Q_{1:0}, and the higher outputs when they are operated in their undivided modes. The frequency appearing at the REF and FB inputs will be FNOM when the output connected to FB is undivided and DS_[1:0] = MM. The frequency of the REF and FB inputs will be FNOM /2 or FNOM /4 when the part is configured for frequency multiplication by using a divided output as the FB input and setting DS_[1:0] = MM. Using the DS_[1:0] inputs allows a different method for frequency multiplication (see Divide Selection Table).
- Skew adjustment range assumes that a zero skew output is used for feedback. If a skewed Q output is used for feedback, then adjustment range will be greater. For example if a 4tu skewed output is used for feedback, all other outputs will be skewed -4tu in addition to whatever skew value is programmed for those outputs. 'Max adjustment' range applies to output pairs 3 and 4 where ±6tu skew adjustment is possible and at the lowest FNOM value.

DIVIDE SELECTION TABLE

DS [1:0]	FB Divide-by-n	Permitted Output Divide-by-n connected to FB _{IN} ⁽¹⁾
LL	2	1 or 2
LM	3	1
LH	4	1, 2, or 4
ML	5	1 or 2
MM	1	1, 2, or 4
MH	6	1 or 2
HL	8	1 or 2
HM	10	1
HH	12	1

NOTE:
1. Permissible output division ratios connected to FB. The frequency of the REF input will be F_{NOM}/N when the part is configured for frequency multiplication by using an undivided output for FB and setting DS[1:0] to N (N = 1-6, 8, 10, 12).

CONTROL SUMMARY TABLE FOR FEEDBACK SIGNALS

nF1:0	Skew (Pair #1, #2)	Skew (Pair #3)	Skew (Pair #4)
LL ⁽¹⁾	-4t _u	Divide by 2	Divide by 2
LM	-3t _u	-6t _u	-6t _u
LH	-2t _u	-4t _u	-4t _u
ML	-1t _u	-2t _u	-2t _u
MM	Zero Skew	Zero Skew	Zero Skew
MH	1t _u	2t _u	2t _u
HL	2t _u	4t _u	4t _u
HM	3t _u	6t _u	6t _u
HH	4t _u	Divide by 4	Inverted ⁽²⁾

NOTES:
1. LL disables outputs if TEST = MID and \overline{sOE} = HIGH.
2. When pair #4 is set to HH (inverted), \overline{sOE} disables pair #4 HIGH when PE = HIGH, \overline{sOE} disables pair #4 LOW when PE = LOW.

RECOMMENDED OPERATING RANGE

Symbol	Description	Min.	Typ.	Max.	Unit
V _{DD} /V _{DDQ}	Power Supply Voltage	2.3	2.5	2.7	V
T _A	Ambient Operating Temperature	-40	+25	+85	°C

DC ELECTRICAL CHARACTERISTICS OVER OPERATING RANGE

Symbol	Parameter	Conditions	Min.	Max.	Unit
V _{IH}	Input HIGH Voltage	Guaranteed Logic HIGH (REF, FB Inputs Only)	2	—	V
V _{IL}	Input LOW Voltage	Guaranteed Logic LOW (REF, FB Inputs Only)	—	0.7	V
V _{IHH}	Input HIGH Voltage ⁽¹⁾	3-Level Inputs Only	V _{DD} −0.4	—	V
V _{IMM}	Input MID Voltage ⁽¹⁾	3-Level Inputs Only	V _{DD} /2−0.2	V _{DD} /2+0.2	V
V _{ILL}	Input LOW Voltage ⁽¹⁾	3-Level Inputs Only	—	0.4	V
I _{IN}	Input Leakage Current (REF, FB Inputs Only)	V _{IN} = V _{DD} or GND V _{DD} = Max.	−5	+5	μA
I ₃	3-Level Input DC Current (TEST, FS, nF _[1:0] , DS _[1:0])	V _{IN} = V _{DD} HIGH Level	—	+200	μA
		V _{IN} = V _{DD} /2 MID Level	−50	+50	
		V _{IN} = GND LOW Level	−200	—	
I _{PU}	Input Pull-Up Current (PE, \overline{PD})	V _{DD} = Max., V _{IN} = GND	−25	—	μA
I _{PD}	Input Pull-Down Current (\overline{sOE})	V _{DD} = Max., V _{IN} = V _{DD}	—	+100	μA
V _{OH}	Output HIGH Voltage	V _{DD} = Min., I _{OH} = −2mA (LOCK Output)	2	—	V
		V _{DDQ} = Min., I _{OH} = −12mA (nQ _[1:0] Outputs)	2	—	
V _{OL}	Output LOW Voltage	V _{DD} = Min., I _{OL} = 2mA (LOCK Output)	—	0.4	V
		V _{DDQ} = Min., I _{OL} = 12mA (nQ _[1:0] Outputs)	—	0.4	

- NOTE:
- These inputs are normally wired to V_{DD}, GND, or unconnected. Internal termination resistors bias unconnected inputs to V_{DD}/2. If these inputs are switched, the function and timing of the outputs may be glitched, and the PLL may require an additional t_{LOCK} time before all datasheet limits are achieved.

POWER SUPPLY CHARACTERISTICS

Symbol	Parameter	Test Conditions ⁽¹⁾	5T995		5T995A		Unit	
			Typ. ⁽²⁾	Max.	Typ. ⁽²⁾	Max.		
I _{DDQ}	Quiescent Power Supply Current	V _{DD} = Max., TEST = MID, REF = LOW, PE = LOW, \overline{sOE} = LOW, \overline{PD} = HIGH FS = MID, All outputs unloaded	20	30	20	30	mA	
I _{DDPD}	Power Down Current	V _{DD} = Max., \overline{PD} = LOW, \overline{sOE} = LOW PE = HIGH, TEST = HIGH, FS = HIGH nF _[1:0] = HH, DS _[1:0] = HH	—	25	—	25	μA	
ΔI _{DD}	Power Supply Current per Input HIGH (REF and FB inputs only)	V _{IN} = 2.3V, V _{DD} = Max., \overline{PD} = LOW TEST = HIGH	1	30	1	30	μA	
I _{DD}	Dynamic Power Supply Current per Output	FS = L	190	290	190	290	μA/MHz	
		FS = M	150	230	150	230		
		FS = H	130	200	130	200		
I _{TOT}	Total Power Supply Current	FS = L	Fvco = 40MHz, C _L = 0pF	49	—	—	mA	
			Fvco = 50MHz, C _L = 0pF	—	—	56		—
		FS = M	Fvco = 80MHz, C _L = 0pF	66	—	—		—
			Fvco = 100MHz, C _L = 0pF	—	—	80		—
		FS = H	Fvco = 160MHz, C _L = 0pF	103	—	—		—
Fvco = 200MHz, C _L = 0pF	—	—	125	—	—			

- NOTES:
- Measurements are for divide-by-1 outputs, nF_[1:0] = MM, and DS_[1:0] = MM.
 - For nominal voltage and temperature.

INPUT TIMING REQUIREMENTS

Symbol	Description ⁽¹⁾	5T995		5T995A		Unit	
		Min.	Max.	Min.	Max.		
t _R , t _F	Maximum input rise and fall times, 0.7V to 1.7V	—	10	—	10	ns/V	
t _{PWC}	Input clock pulse, HIGH or LOW	2	—	2	—	ns	
D _H	Input duty cycle	10	90	10	90	%	
F _{REF}	Reference clock input frequency	FS = LOW	2	40	2	50	MHz
		FS = MID	3.33	80	4	100	
		FS = HIGH	6.67	160	8	200	

NOTE:

- Where pulse width implied by D_H is less than t_{PWC} limit, t_{PWC} limit applies.

SWITCHING CHARACTERISTICS OVER OPERATING RANGE

Symbol	Parameter	5T995			5T995A			Unit
		Min.	Typ.	Max.	Min.	Typ.	Max.	
FNOM	VCO Frequency Range	See Programmable Skew Range and Resolution Table						
tRPWH	REF Pulse Width HIGH ⁽¹⁾	2	—	—	2	—	—	ns
tRPWL	REF Pulse Width LOW ⁽¹⁾	2	—	—	2	—	—	ns
t _u	Programmable Skew Time Unit	See Control Summary Table						
tSKEWPR	Zero Output Matched-Pair Skew (xQ0, xQ1) ^(2,3)	—	50	185	—	50	185	ps
tSKEW0	Zero Output Skew (All Outputs) ⁽⁴⁾	—	0.1	0.25	—	0.1	0.25	ns
tSKEW1	Output Skew (Rise-Rise, Fall-Fall, Same Class Outputs) ⁽⁵⁾	—	0.1	0.25	—	0.1	0.25	ns
tSKEW2	Output Skew (Rise-Fall, Nominal-Inverted, Divided-Divided) ⁽⁵⁾	—	0.2	0.5	—	0.2	0.5	ns
tSKEW3	Output Skew (Rise-Rise, Fall-Fall, Different Class Outputs) ⁽⁵⁾	—	0.15	0.5	—	0.15	0.5	ns
tSKEW4	Output Skew (Rise-Fall, Nominal-Divided, Divided-Inverted) ⁽²⁾	—	0.3	0.9	—	0.3	0.9	ns
tDEV	Device-to-Device Skew ^(2,6)	—	—	0.75	—	—	0.75	ns
t _{(φ)1-3}	Static Phase Offset (FS = L, M, H) (FB Divide-by-n = 1, 2, 3) ⁽⁷⁾	-0.3	—	0.3	-0.25	—	0.25	ns
t _{(φ)H}	Static Phase Offset (FS = H) ⁽⁷⁾	-0.5	—	0.5	-0.25	—	0.25	ns
t _{(φ)M}	Static Phase Offset (FS = M) ⁽⁷⁾	-0.7	—	0.7	-0.5	—	0.5	ns
t _{(φ)L1-6}	Static Phase Offset (FS = L) (FB Divide-by-n = 1, 2, 3, 4, 5, 6) ⁽⁷⁾	-0.7	—	0.7	-0.7	—	0.7	ns
t _{(φ)L8-12}	Static Phase Offset (FS = L) (FB Divide-by-n = 8, 10, 12) ⁽⁷⁾	-1	—	1	-1	—	1	ns
tODCV	Output Duty Cycle Variation from 50%	-1	—	1	-1	—	1	ns
tPWH	Output HIGH Time Deviation from 50% ⁽⁸⁾	—	—	1.5	—	—	1.5	ns
tPWL	Output LOW Time Deviation from 50% ⁽⁹⁾	—	—	2	—	—	2	ns
tORISE	Output Rise Time	0.15	0.7	1.5	0.15	0.7	1.5	ns
tOFALL	Output Fall Time	0.15	0.7	1.5	0.15	0.7	1.5	ns
t _{LOCK}	PLL Lock Time ^(10,11)	—	—	0.5	—	—	0.5	ms
tCCJH	Cycle-to-Cycle Output Jitter (peak-to-peak) (divide by 1 output frequency, FS = H, FB divide-by-n=1,2)	—	—	100	—	—	100	ps
tCCJHA	Cycle-to-Cycle Output Jitter (peak-to-peak) (divide by 1 output frequency, FS = H, FB divide-by-n=any)	—	—	150	—	—	150	
tCCJM	Cycle-to-Cycle Output Jitter (peak-to-peak) (divide by 1 output frequency, FS = M)	—	—	200	—	—	150	
tCCJL	Cycle-to-Cycle Output Jitter (peak-to-peak) (divide by 1 output frequency, FS = L, F _{REF} > 3MHz)	—	—	200	—	—	200	
tCCJLA	Cycle-to-Cycle Output Jitter (peak-to-peak) (divide by 1 output frequency, FS = L, F _{REF} < 3MHz)	—	—	300	—	—	300	

NOTES:

1. Refer to Input Timing Requirements table for more detail.
2. Skew is the time between the earliest and the latest output transition among all outputs for which the same t_u delay has been selected when all are loaded with the specified load.
3. tSKEWPR is the skew between a pair of outputs (xQ0 and xQ1) when all eight outputs are selected for 0t_u.
4. tSK(0) is the skew between outputs when they are selected for 0t_u.
5. There are 3 classes of outputs: Nominal (multiple of t_u delay), Inverted (4Q0 and 4Q1 only with 4F0 = 4F1 = HIGH), and Divided (3Qx and 4Qx only in Divide-by-2 or Divide-by-4 mode). Test condition: nF0:1=MM is set on unused outputs.
6. tDEV is the output-to-output skew between any two devices operating under the same conditions (V_{DDQ}, V_{DD}, ambient temperature, air flow, etc.)
7. t_φ is measured with REF input rise and fall times (from 0.7V to 1.7V) of 0.5ns. Measured from 1.25V on REF to 1.25V on FB.
8. Measured at 1.7V.
9. Measured at 0.7V.
10. t_{LOCK} is the time that is required before synchronization is achieved. This specification is valid only after V_{DDQ}/V_{DD} is stable and within normal operating limits. This parameter is measured from the application of a new signal or frequency at REF or FB until t_{PD} is within specified limits.
11. Lock detector may be unreliable for input frequencies less than approximately 4MHz, or for input signals which contain significant jitter.

AC TEST LOADS AND WAVEFORMS

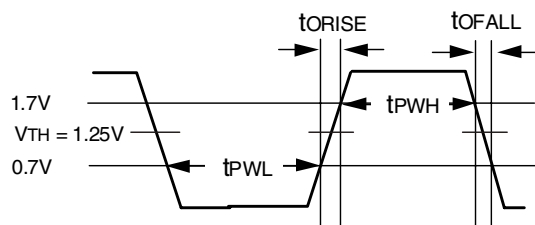
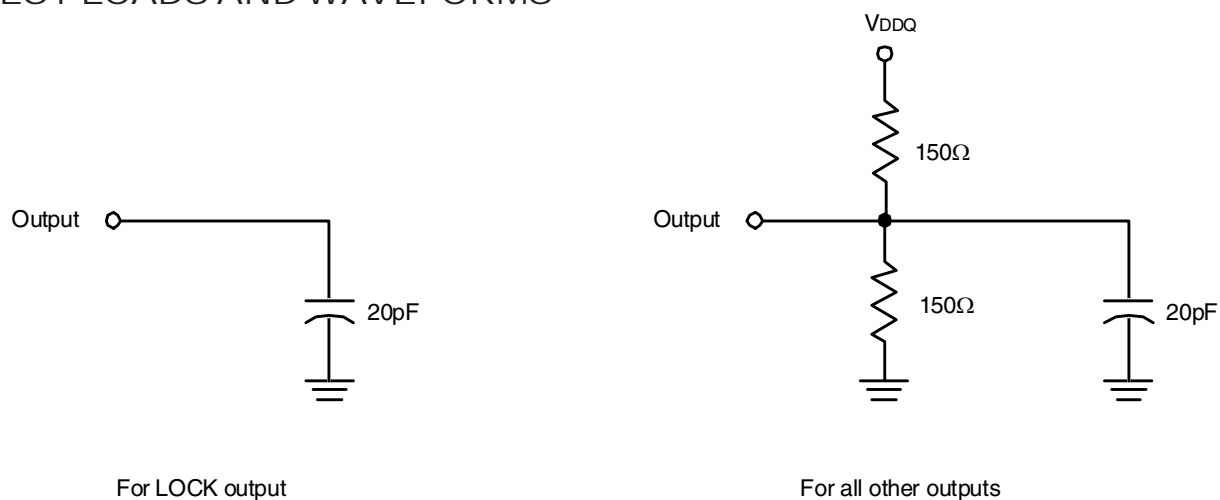

2.5V Output Waveform

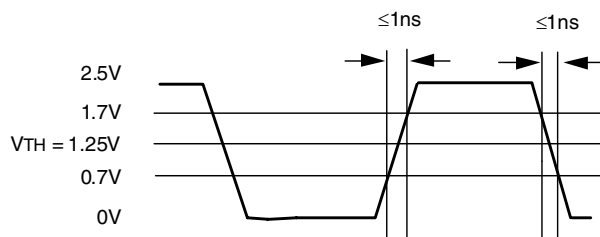

LVTTL Input Test Waveform

AC TIMING DIAGRAM

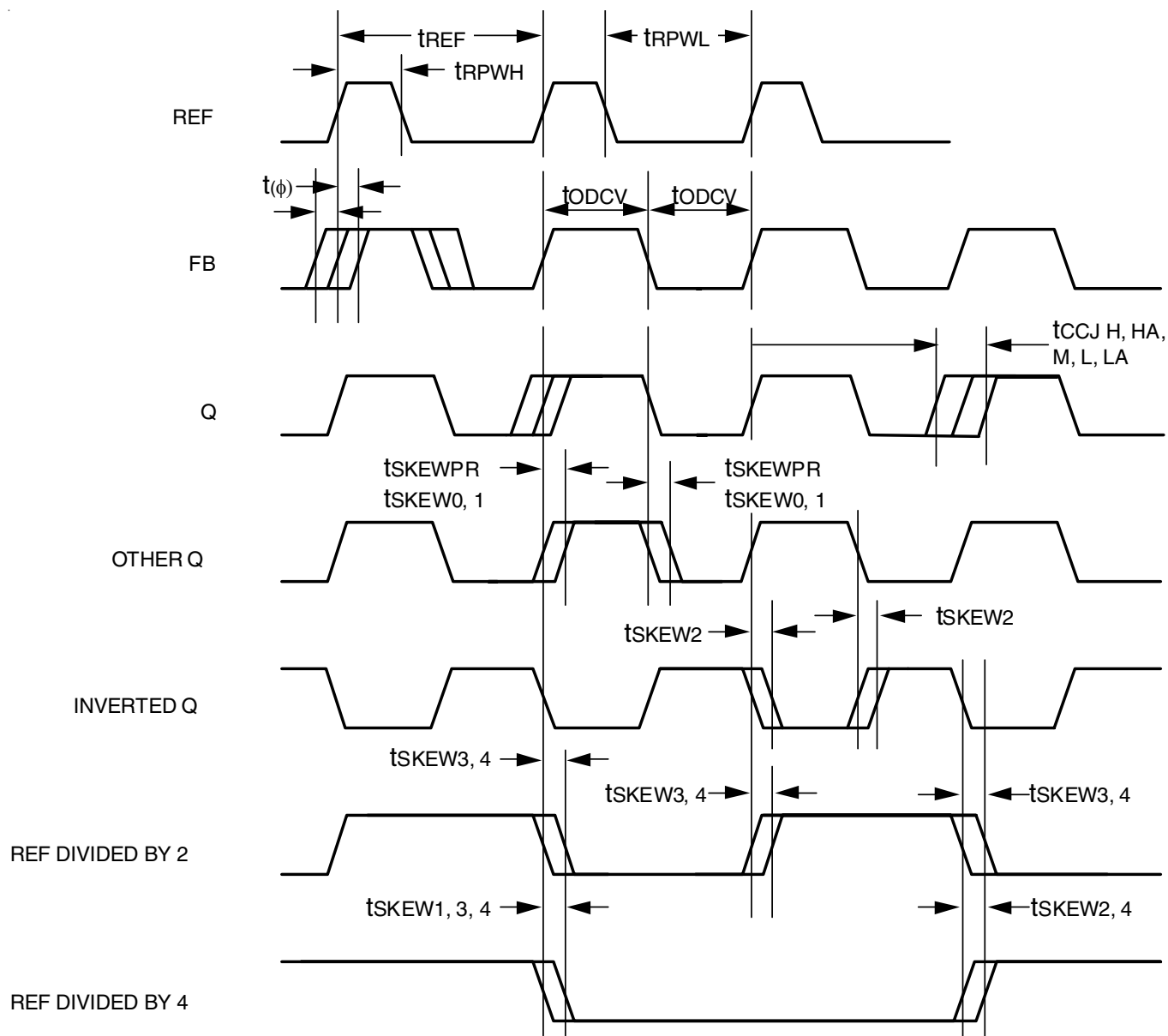

NOTES:

- PE: The AC Timing Diagram applies to PE=V_{DD}. For PE=GND, the negative edge of FB aligns with the negative edge of REF, divided outputs change on the negative edge of REF, and the positive edges of the divide-by-2 and the divide-by-4 signals align.
- Skew: The time between the earliest and the latest output transition among all outputs for which the same t_u delay has been selected when all are loaded with 20pF and terminated with 75Ω to V_{DDQ}/2.
- t_{SKEWPR}: The skew between a pair of outputs (xQ0 and xQ1) when all eight outputs are selected for 0t_u.
- t_{SKEW0}: The skew between outputs when they are selected for 0t_u.
- t_{DEV}: The output-to-output skew between any two devices operating under the same conditions (V_{DDQ}, V_{DD}, ambient temperature, air flow, etc.)
- t_{ODCV}: The deviation of the output from a 50% duty cycle. Output pulse width variations are included in t_{SKEW2} and t_{SKEW4} specifications.
- t_{PWH} is measured at 1.7V.
- t_{PWL} is measured at 0.7V.
- t_{ORISE} and t_{OFALL} are measured between 0.7V and 1.7V.
- t_{LOCK}: The time that is required before synchronization is achieved. This specification is valid only after V_{DD}/V_{DDQ} is stable and within normal operating limits. This parameter is measured from the application of a new signal or frequency at REF or FB until t_{PD} is within specified limits.

ORDERING INFORMATION

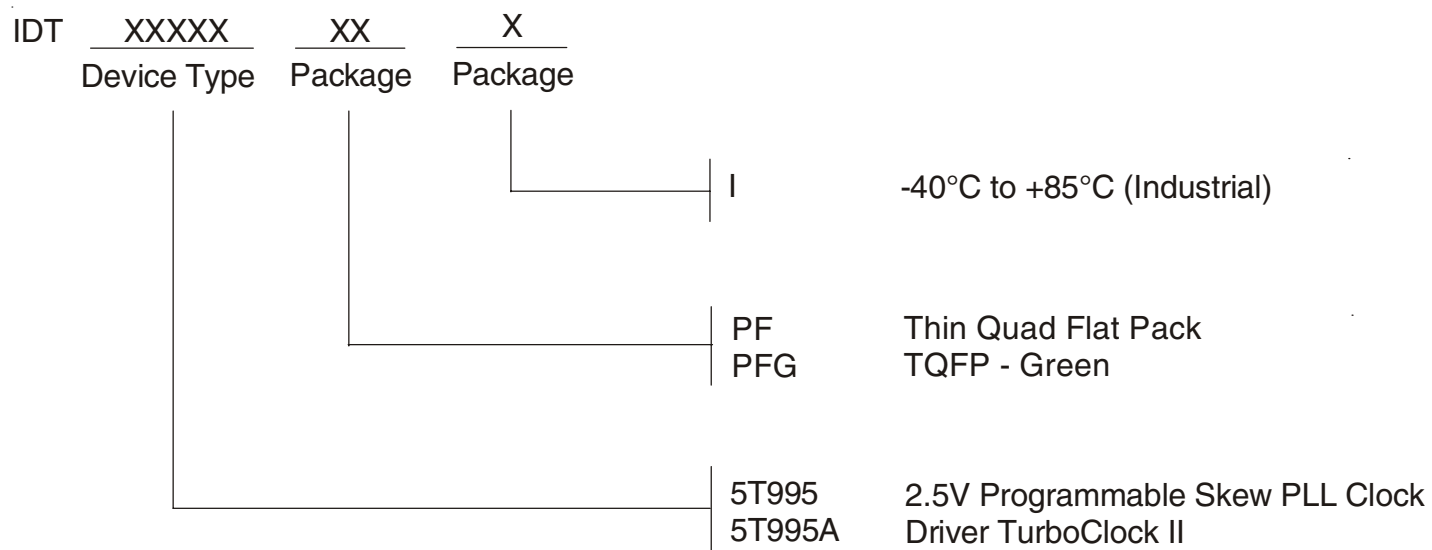

CORPORATE HEADQUARTERS
6024 Silver Creek Valley Road
San Jose, CA 95138

for SALES:
800-345-7015 or 408-284-8200
fax: 408-284-2775
www.idt.com

for Tech Support:
clockhelp@idt.com