

HF Front End for Car Radios and HiFi Receivers

Description

Technology: Bipolar

Features

- Completely integrated FM front end increases quality level and reliability
- High performance due to three AGC loops allow extreme large signal handling
- Fulfills FTZ rules
- Double-balanced high linear mixer with low-noise figure
- Oscillator with low phase noise and excellent frequency stability
- IF preamplifier with dB-linear gain control
- Low noise and high stability of the reference voltage circuit for internal and auxiliary functions

Block Diagram

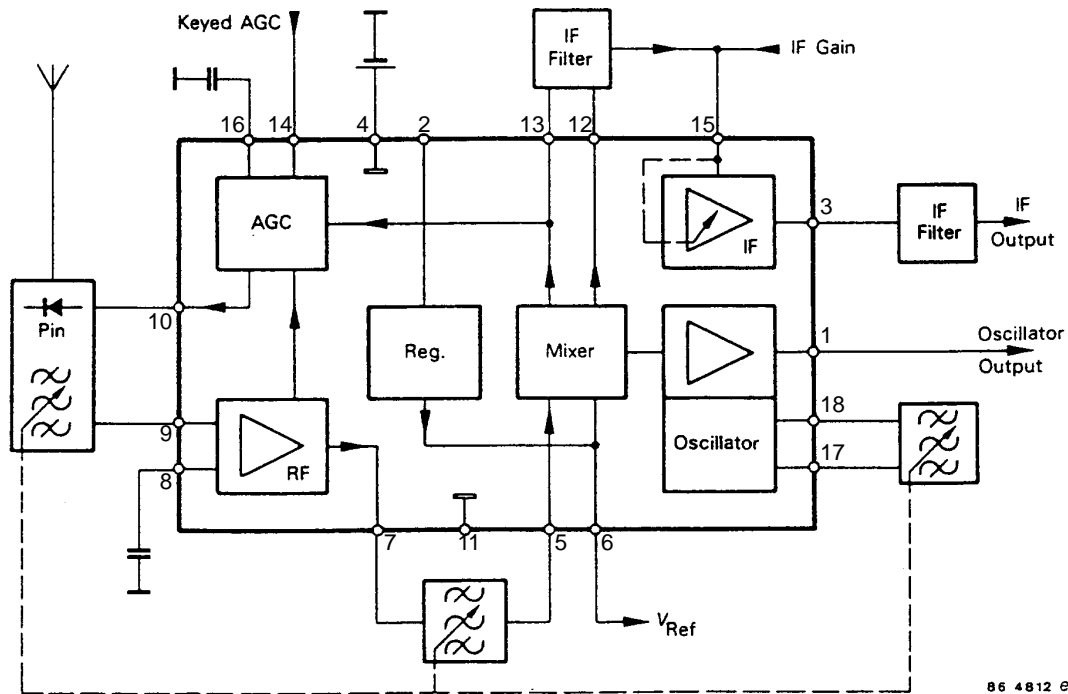

Figure 1. Block diagram

Ordering Information

Extended Type Number	Package	Remarks
U4062B-B	DIP18	

Pin Description

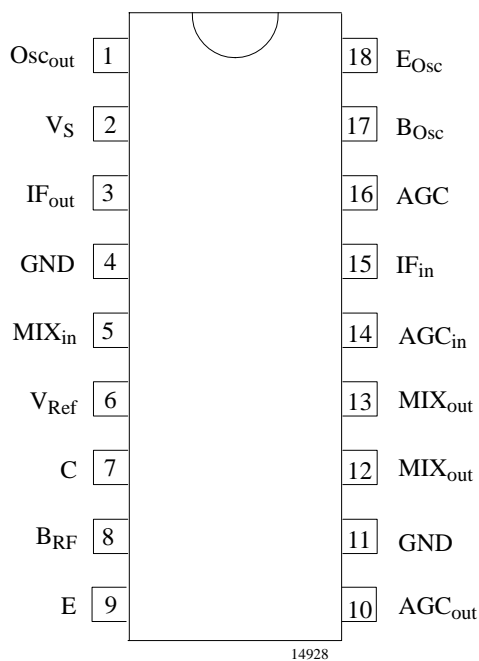

Figure 2. Pinning DIP18

Pin	Symbol	Function
1	Osc _{out}	Oscillator output
2	V _S	Supply voltage
3	IF _{out}	IF output
4	GND	Ground
5	MIX _{in}	Mixer input
6	V _{Ref}	Reference voltage output
7	C	Collector
8	B _{RF}	Base, RF preamplifier
9	E	Emitter
10	AGC _{out}	AGC output
11	GND	Ground
12	MIX _{out}	Mixer output
13	MIX _{out}	Mixer output
14	AGC _{in}	AGC input (IF strip)
15	IF _{in}	IF input / IF gain control
16	AGC	AGC time constant
17	B _{Osc}	Base oscillator
18	E _{Osc}	Emitter oscillator

Absolute Maximum Ratings

Reference point ground, Pins 4 and 11

Parameters	Symbol	Value	Unit
Supply voltage Pins 2, 12 and 13	V _S	18	V
Power dissipation T _{amb} = 85°C	P _{tot}	450	mW
Junction temperature	T _j	125	°C
Storage temperature range	T _{stg}	-50 to +125	°C
Ambient temperature range	T _{amb}	-25 to +85	°C

Thermal Resistance

Parameters	Symbol	Value	Unit
Junction ambient	R _{thJA}	90	K/W

Electrical Characteristics

$V_S = 10\text{ V}$, $f_{iRF} = 50.3\text{ MHz}$, $f_{Osc} \approx 100\text{ MHz}$, $f_{IF} = f_{Osc} - f_{iRF} \approx 49.7\text{ MHz}$, reference point Pins 4 and 11, $T_{amb} = +25^\circ\text{C}$, unless otherwise specified, see test circuit figure 4.

Parameters	Test Conditions / Pins	Symbol	Min.	Typ.	Max.	Unit
Supply voltage range		V_S	7		16	V
Supply currents						
Supply current	Pin 2	I_S		11.5		mA
Mixer	Pins 12 and 13	$I_{12} + I_{13}$		9		mA
RF stage	$R_4 = 470\ \Omega$ Pin 7	I_7		9		mA
RF preamplifier ($R_{g9} = 50\ \Omega$, $R_{L7} = 200\ \Omega$)						
DC voltage	Pin 7	V_7		5.7		V
	Pin 8	V_8		0.77		V
Power gain		G_{RF}		10.5		dB
Third order intercept		IP_3		12		dBm
Dynamic characteristics, $f = 100\text{ MHz}$						
Input impedance		Z_9			5	Ω
Forward current gain	$ i_7/i_9 $	h_{fb}		1		A/A
Parallel output resistance		R_7		3		k Ω
Parallel output capacitance		C_1		3.8		pF
Noise figure		NF_{RF}		2		dB
Oscillator ($f_{Osc} = 100\text{ MHz}$, unloaded $Q = 80$, resonance resistance $R_{g17} = 250\ \Omega$)						
DC voltage	Pin 17	V_{17}		3.2		V
	Pin 18	V_{18}		2.5		V
Oscillator voltage	Pin 17	V_{Osc17}	100	130		mV
Frequency drift	By supply voltage change d_{f_o}/dV_S	$\Delta f_{Osc}(V_S)$		1.3		kHz/V
	By temperature change d_{f_o}/dT_K	$\Delta f_{Osc}(T_j)$		2		kHz/K
FM noise equivalent deviation, (Ripple voltage < 0.5 mV)	Frequency band 300 Hz to 20 kHz, unweighted	Δf_{noise}		5		Hz
	Peak CCIR	Δf_{noise}		10.5		Hz
	Peak CCIR, weighted with 75 μ s, deemphasis	Δf_{noise}		4.2		Hz
FM by AM signal at mixer input	$f_{iRF} = 90\text{ MHz}$, $m = 0.8$, $f_M = 1\text{ kHz}$, $V_{iRF} = 106\text{ dB}\mu\text{V}$	$\Delta f_{Osc}(V_{iRF})$		160		Hz
Oscillator output buffer ($R_{L1} = 520\ \Omega$)						
DC current load limitation	Pin 1	I_1			0.2	mA
DC voltage	Pin 1	V_1		1.7		V
Voltage gain	$V_{Osc17} \leq 200\text{ mV}$ V_{Osc1}/V_{Osc17} Pin 1	G_{buffer}		0.86		
Harmonics				< -30		dBc
Output impedance	Pin 1	Z_1		80		Ω

Electrical Characteristics (continued)

$V_S = 10\text{ V}$, $f_{iRF} = 50.3\text{ MHz}$, $f_{Osc} \approx 100\text{ MHz}$, $f_{IF} = f_{Osc} - f_{iRF} \approx 49.7\text{ MHz}$, reference point Pins 4 and 11, $T_{amb} = 25^\circ\text{C}$, unless otherwise specified, see test circuit figure 4.

Parameters	Test Conditions / Pins	Symbol	Min.	Typ.	Max.	Unit
Mixer ($R_{g5} = 200\ \Omega$, $R_{L12-13} = 200\ \Omega$)						
Conversion power gain		G_C		7.5		dB
Third order intercept		IP_3		3.5		dBm
Parallel input resistance	$f = 100\text{ MHz}$ Pin 5	R_5		5		k Ω
Parallel input capacitance	$f = 100\text{ MHz}$ Pin 5	C_5		3		pF
Parallel output resistance	$f = 10.7\text{ MHz}$, Pins 12, 13 parallel connected	R_{12+13}		55		k Ω
Effective output capacitance between Pin 12 and 13	$f = 10.7\text{ MHz}$	C_{12-13}	2.9	3.1	3.3	pF
	$V_{12,13} = 10\text{ V}$	C_{12-13}	3.25	3.5	3.75	pF
	$V_{12,13} = 16\text{ V}$	C_{12-13}	2.5	2.7	2.9	pF
Conversion transconductance	$ i_{12}/u_5 $, $ i_{13}/u_5 $	g_c		5.8		m-mho
Maximum available conversion power gain	$f_{iRF} = 100\text{ MHz}$, $f_{IF} = 10.7\text{ MHz}$	MACG		43		dB
Noise figure ($f_{IF} = 10.7\text{ MHz}$) Single side band	$R_{g5}(f_{iRF}) = 450\ \Omega$, $f_{iRF} = f_{Osc} - f_{IF}$	NF _{CSSB}		5.6		dB
IF preamplifier ($f = 10.7\text{ MHz}$, $R_{L3} = R_{g15} = 200\ \Omega$)						
DC voltage	Pin 3	V_3		7.6		V
Power gain	Maximum control voltage of $V_{15} = 1.6\text{ V}$ is recommended $V_{15} = 1.6\text{ V}$ $V_{15} < 0.8\text{ V}$	G_{maxIF}		24		dB
		G_{minIF}		-4		dB
Gain control deviation by V_{15}		ΔG_{IF}		28		dB
External control current	at G_{maxIF} at G_{minIF} Pin 15	I_{15max}		20		μA
		I_{15min}		0		μA
Gain control slope	dG_{IF}/dI_{15} dG_{IF}/dV_{15} Pin 15	S_{I15}		1.3		dB/ μA
		S_{V15}		35		dB/V
Temperature coefficient of voltage gain	dG_{IF}/dT_j at $V_{15} = 1.6\text{ V}$ $V_{15} < 0.8\text{ V}$ $I_{15} = \text{constant}$	TCG		0		dB/K
				0.04		dB/K
				-0.02		dB/K
Parallel input resistance	Pin 15	R_{15}		2.4		k Ω
Parallel input capacitance	Pin 15	C_{15}		5.9		pF
Parallel output resistance	Pin 3	R_3		350		Ω
Parallel output capacitance	Pin 3	C_3		4.1		pF
Noise figure	$V_{15} = 1.6\text{ V}$	NF _{IF}		11		dB

Electrical Characteristics (continued)

$V_S = 10\text{ V}$, $f_{iRF} = 50.3\text{ MHz}$, $f_{Osc} \approx 100\text{ MHz}$, $f_{IF} = f_{Osc} - f_{iRF} \approx 49.7\text{ MHz}$, reference point Pins 4 and 11, $T_{amb} = 25^\circ\text{C}$, unless otherwise specified, see test circuit figure 4.

Parameters	Test Conditions / Pins	Symbol	Min.	Typ.	Max.	Unit
AGC circuit (no signal at Pins 5 and 9)						
DC voltage	Pin 16	V_{16}		1.0		V
Saturation voltage	Pin 10	V_{10min}		0.08	0.2	V
Input current	$V_{14} \leq V_6$ Pin 14	$-I_{14}$		0.01	0.1	μA
Maximum allowable current	Pin 14	$ \pm I_{14} _{max}$			50	μA
Maximum control current for external PIN-diode	$I_{10} = 0$	I_{diode}			I_7	
AGC threshold voltages (respecting $V_{10} = 0.25\text{ V}$)						
RF stage output	Pin 7	V_{RF7}		450		mV
Mixer-stage output	$V_{14} = V_6$ Pin 13	V_{IF13}		300		mV
External AGC voltage	$V_{IF13} = 1\text{ V}$ Pin 14	V_{14min}		0.9		V
Internal AGC voltage	Pin 16	V_{16min}		1.4		V
Reference voltage source						
Output voltage, without load	$I_6 = 0$ Pin 6	V_6	1.6	1.7	1.8	V
Temperature dependence of V_6	$ V_6 $ $T_{amb} = -25$ to $+85^\circ\text{C}$	$\Delta V_6 (T)$		20		mV
Internal differential resistance	dV_6/dI_6 when $I_6 = 0\text{ mA}$	r_{d6}		50		Ω
Ripple rejection	$20 \log (dV_S/dV_6)$ when $I_6 = 0\text{ mA}$	α_6		65		dB
Noise voltage / $\sqrt{\text{Hz}}$	when $I_6 = 0$ and $f = 25\text{ Hz}$ $f = 125\text{ Hz}$ $f = 1\text{ kHz}$ $f = 10\text{ kHz}$			0.6 0.37 0.1 0.1		μV μV μV μV

Test Circuit

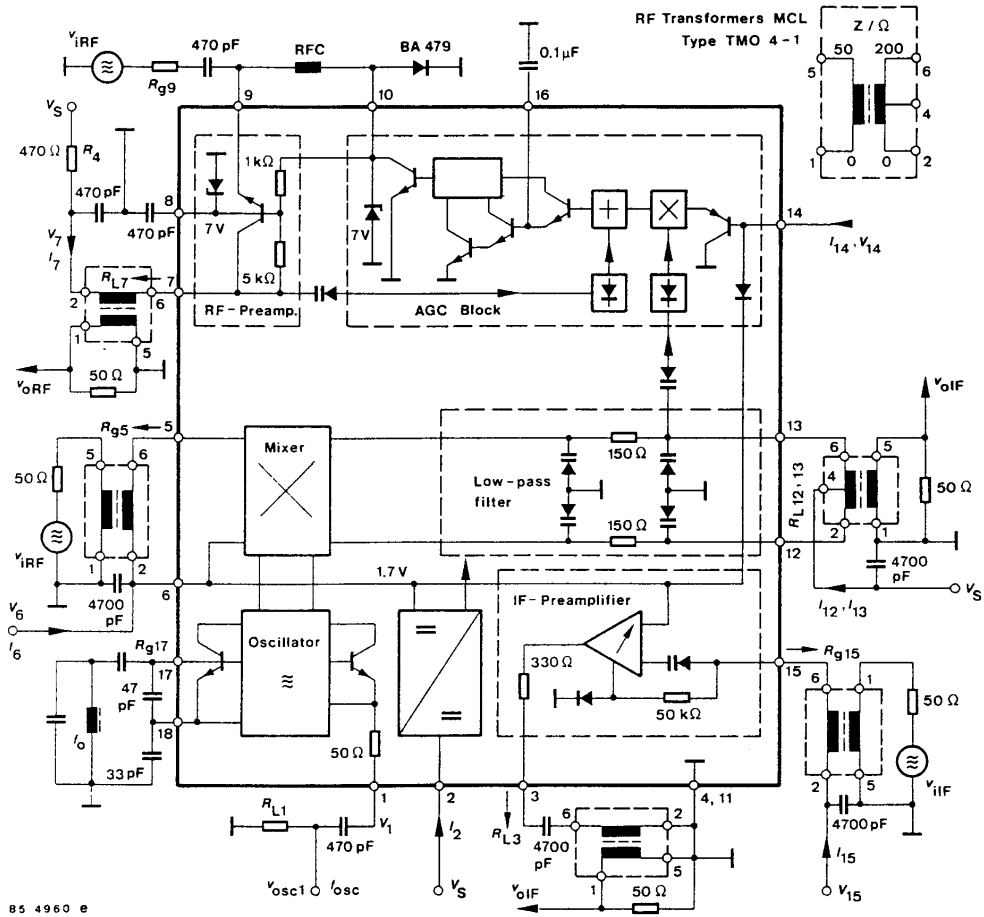

Figure 3. Test circuit

RF Preamplifier

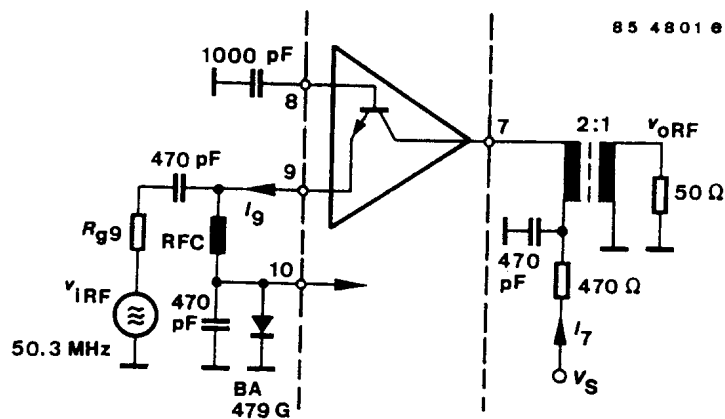

Figure 4. Test circuit

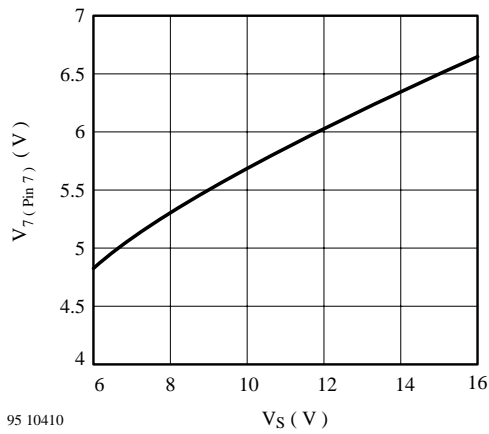

Figure 5. V_7 vs. V_S

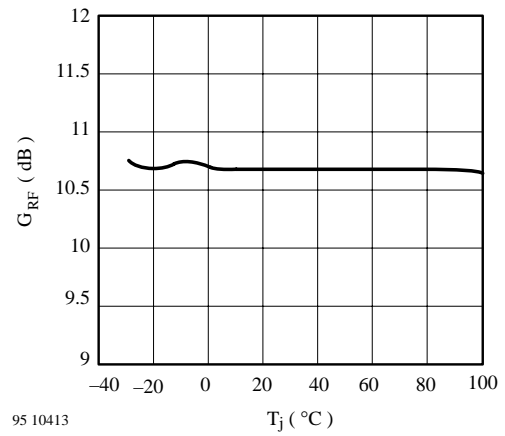

Figure 8. G_{RF} vs. T_j

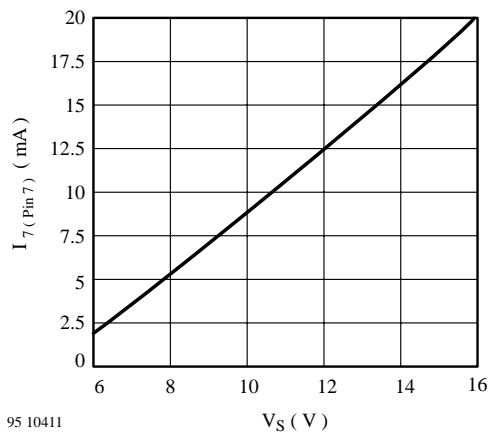

Figure 6. I_7 vs. V_S

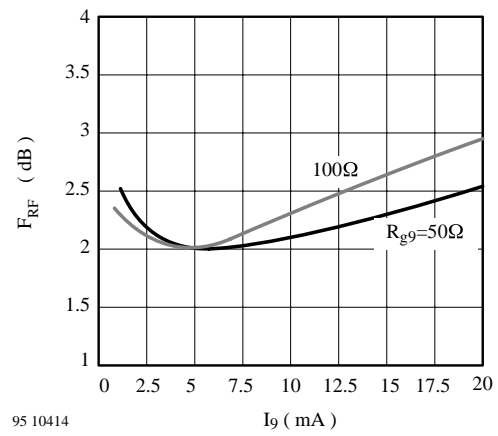

Figure 9. F_{RF} vs. I_g

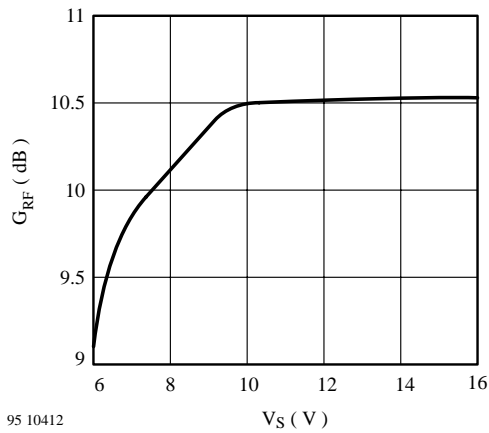

Figure 7. G_{RF} vs. V_S

Oscillator/ Oscillator Output Buffer

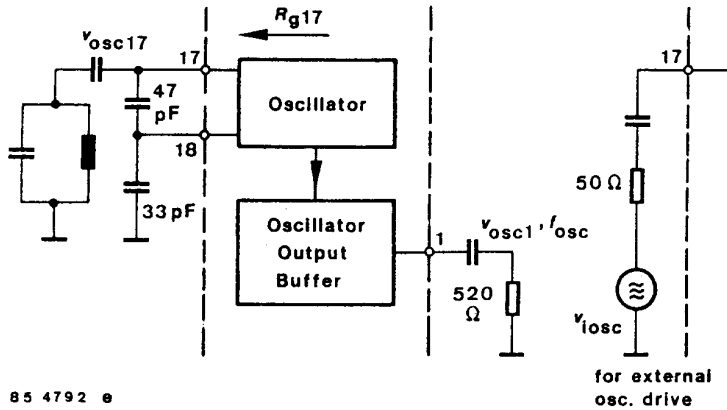

Figure 10. Test circuit – free running oscillator frequency $f_{osc} \approx 100$ MHz

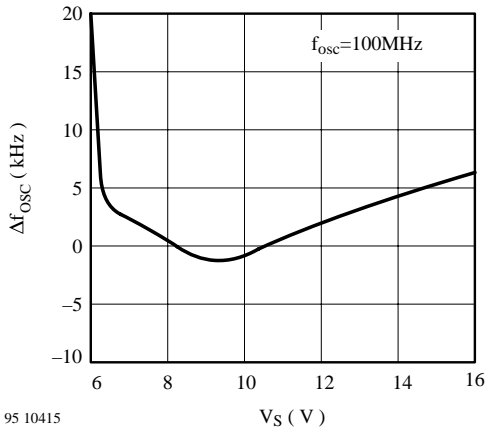

Figure 11. Δf_{osc} vs. V_S

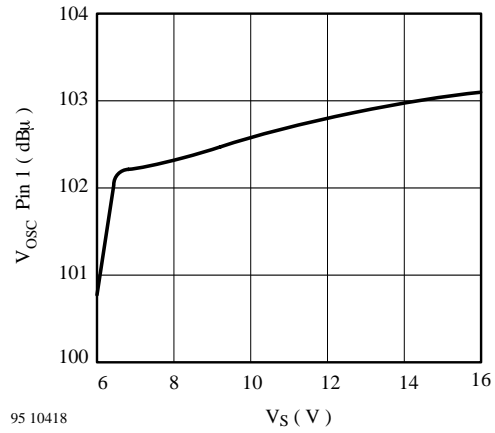

Figure 13. V_{osc} vs. V_S

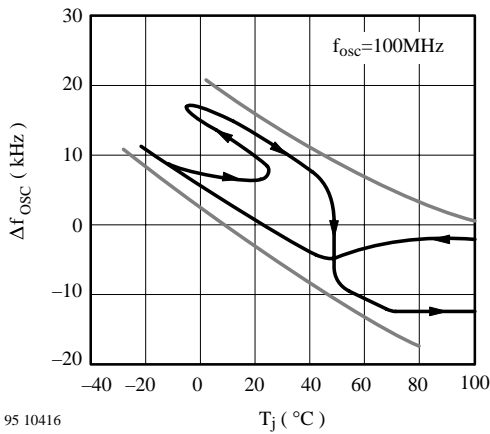

Figure 12. Δf_{osc} vs. T_j

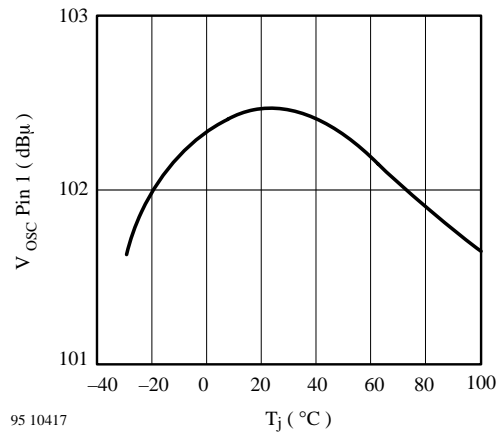

Figure 14. V_{osc} vs. T_j

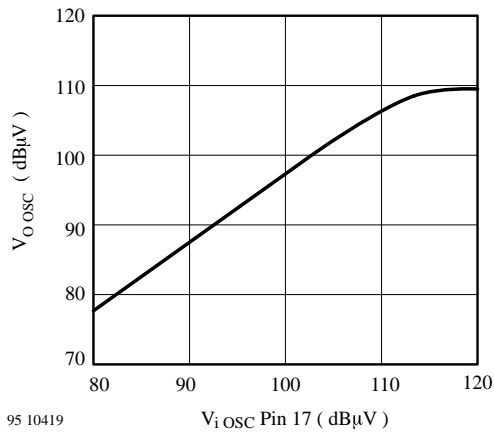

Figure 15. V_{Osc} vs. $V_{i\text{ Osc}}$

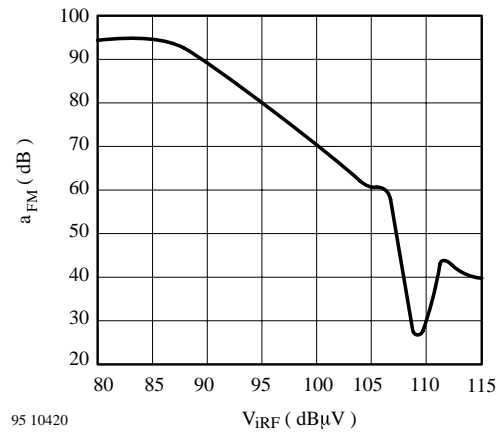
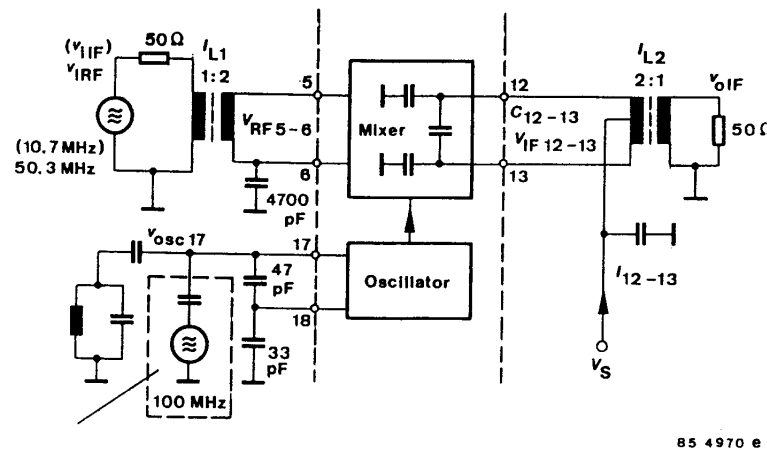

Figure 16. a_{FM} vs. $V_{i\text{ RF}}$

Mixer



For test's versus $v_{\text{osc 17}}$ only

Figure 17. Test circuit

- I_{L1}, I_{L2} = Insertion loss of the RF transformers
- Conversion power gain $G_C = 20 \log (2 V_{o\text{ IF}}/V_{i\text{ RF}}) + I_{L1} \text{ (dB)} + I_{L2} \text{ (dB)}$
- $V_{\text{RF5-6}} \text{ (dBμV)} = V_{i\text{ RF}} \text{ (dBμV)} - I_{L1} \text{ (dB)} + 6$
- $V_{\text{IF12-13}} \text{ (dBμV)} = V_{o\text{ IF}} \text{ (dBμV)} - I_{L2} \text{ (dB)} + 6$
- $\Delta G_C = G_C (V_{\text{OSC17}}) - G_C \text{ (nominal)}$
- Input to output IF isolation
- $a_{\text{IF}} = 20 \log (2 V_{o\text{ IF}}/V_{i\text{ IF}}) + I_{L1} \text{ (dB)} + I_{L2} \text{ (dB)} - G_C \text{ (nominal)}$

Characteristics α_{FM} versus $v_{i\text{ RF}}$ see previous page

Oscillator frequency immunity against amplitude modulated signal at mixer input (Pin 5–6) related to FM standard modulation:

$$\alpha_{\text{FM}} = 20 \log [75 \text{ kHz}/\Delta f_{\text{OSC}}(v_{i\text{ RF}})] \text{ whereas}$$

$$v_{i\text{ RF}} = \text{mixer input signal } (f_{i\text{ RF}} = 89.3 \text{ MHz, } m = 0.8, f_{\text{M}} = 1 \text{ kHz})$$

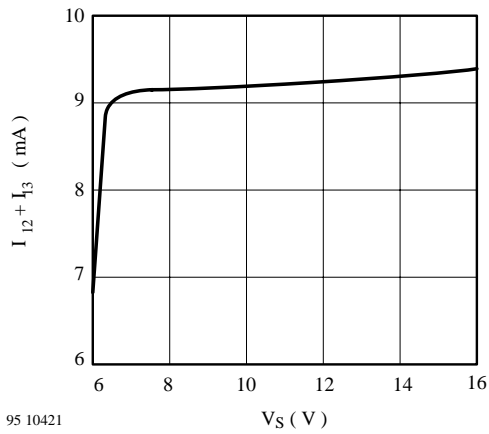

Figure 18. $I_{12} + I_{13}$ vs. V_S

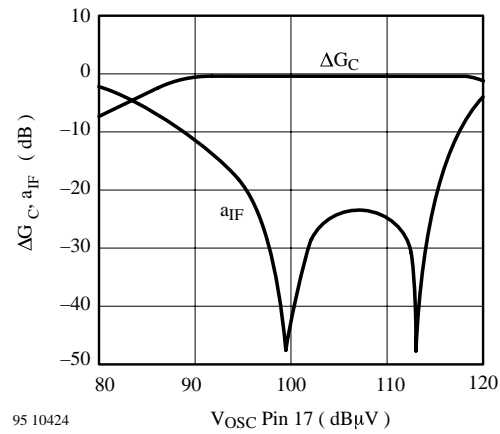

Figure 21. $\Delta G_C, a_{IF}$ vs. V_{Osc} Pin 17

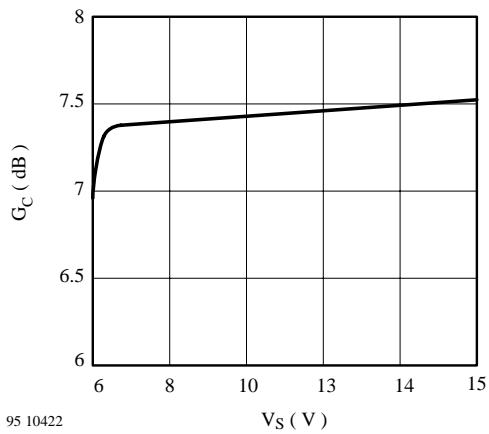

Figure 19. G_C vs. V_S

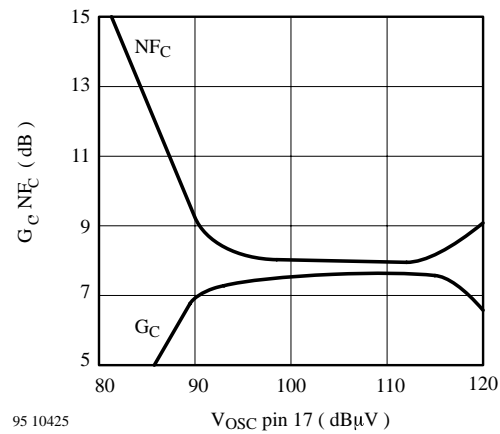

Figure 22. G_C, N_{FC} vs. V_{Osc} Pin 17

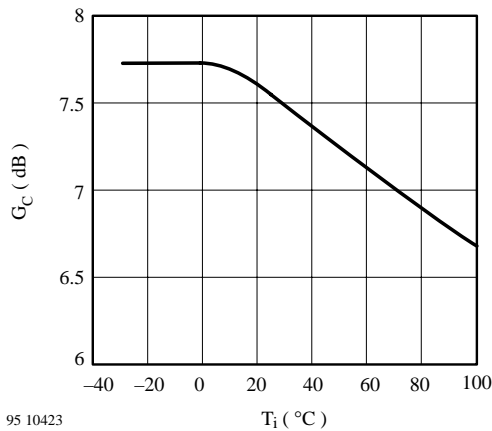

Figure 20. G_C vs. T_j

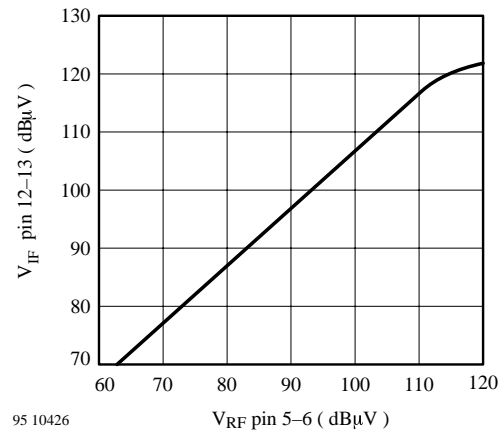

Figure 23. V_{IF} Pin 5-6 vs. V_{RF} Pin 5-6

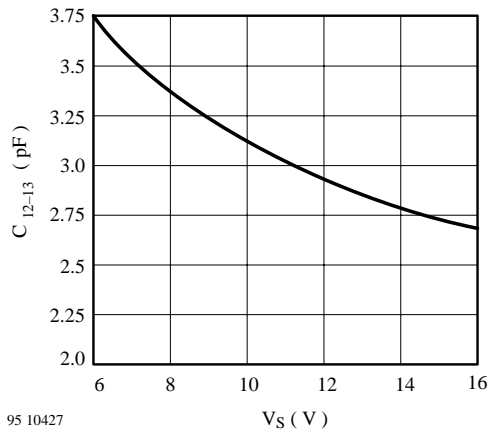

Figure 24. C_{12-13} vs. V_S

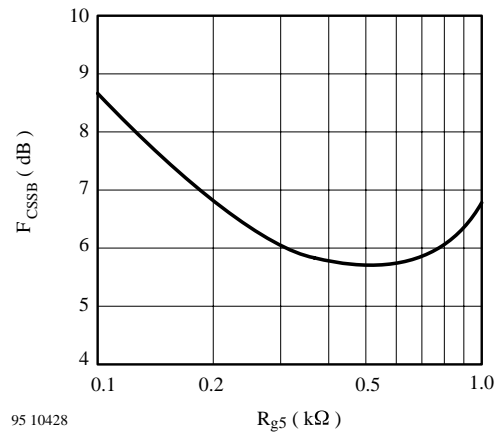

Figure 25.
 F_{CSSB} = Noise figure reading /dB- I_L /dB
 I_L = Insertion loss of the tuned transformer network

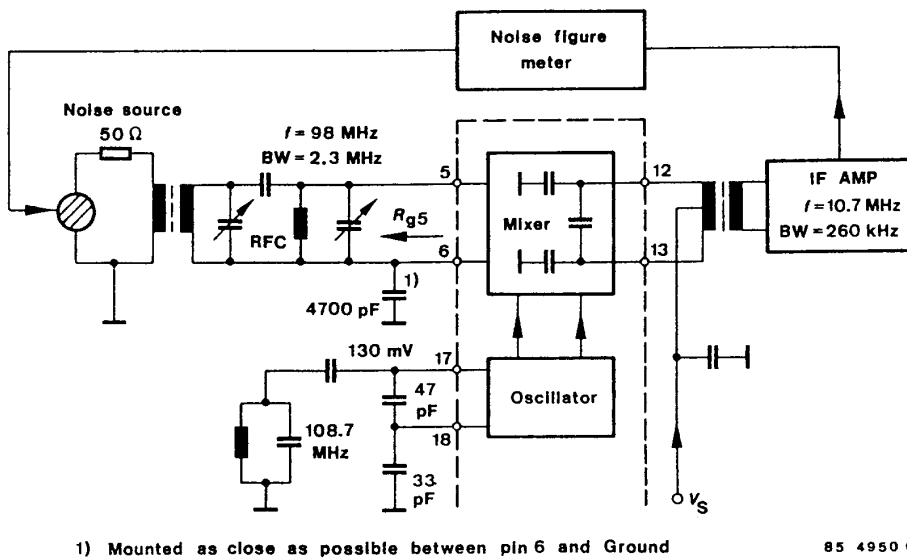

Figure 26. Test circuit for single sideband noise (F_{CSSB})

AGC Circuit

I_{L1}, I_{L2} = Insertion loss of the RF transformers,
 $V_{RF7} \text{ (dB}\mu\text{V)} = V_{IRF} \text{ (dB}\mu\text{V)} - I_{L1} \text{ (dB)} + 6$
 $V_{IF13} \text{ (dB}\mu\text{V)} = V_{iIF} \text{ (dB}\mu\text{V)} - I_{L2} \text{ (dB)}$

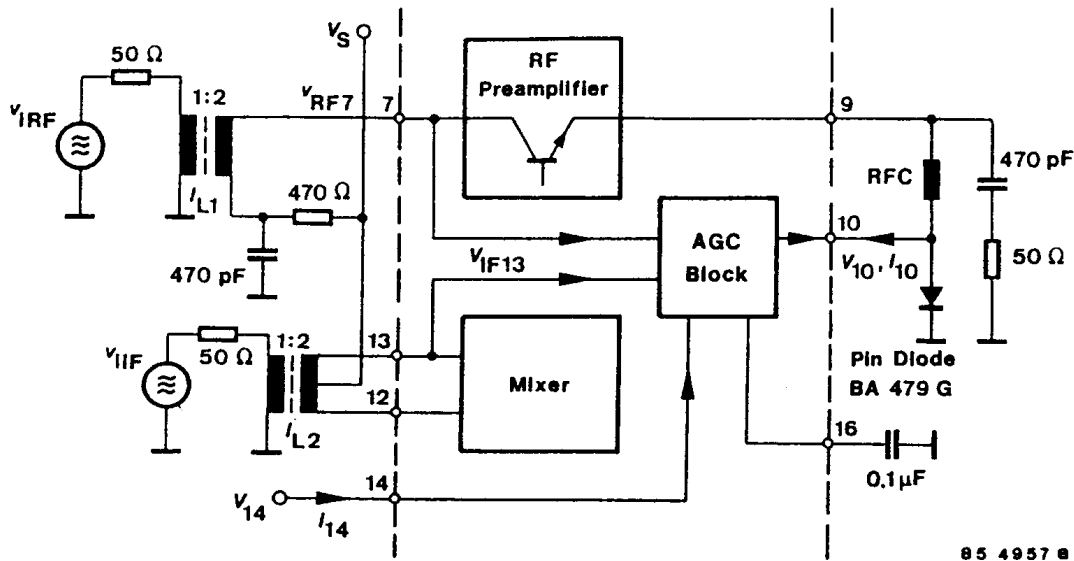

Figure 27. Test circuit

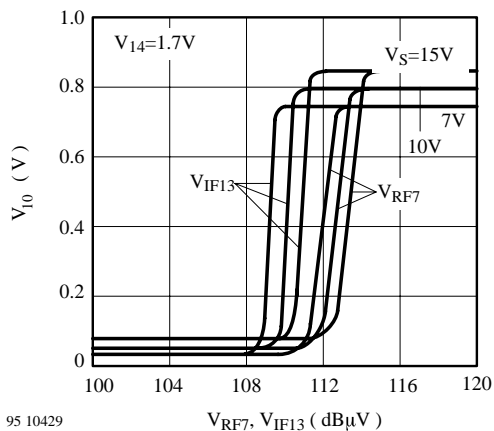

Figure 28. V_{10} vs. V_{RF7}, V_{IF13}

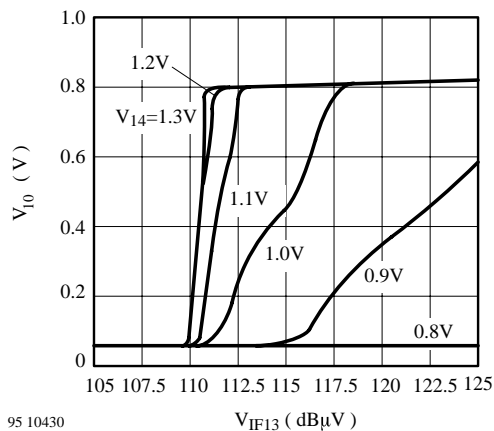

Figure 29. V_{10} vs. V_{IF13}

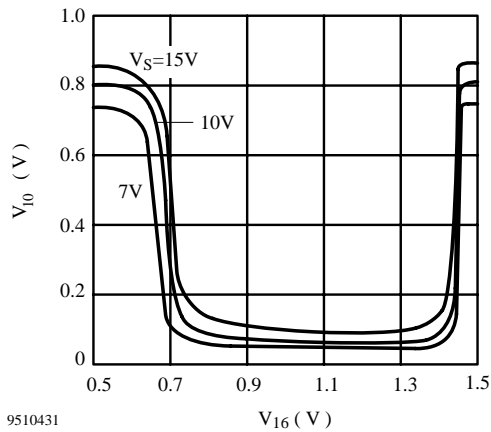

Figure 30. V_{10} vs. V_{16}

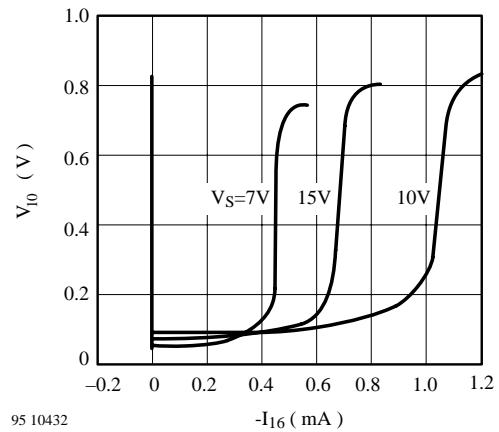

Figure 31. V_{10} vs. $-I_{16}$

IF Preampifier

I_{L1}, I_{L2} = Insertion loss of the RF transformers

Power gain $G_F = 20 \log (2 V_{oIF}/V_{iRF}) + I_{L1} \text{ (dB)} + I_{L2} \text{ (dB)}$

$V_{iIF15} \text{ (dB}\mu\text{V)} = V_{iIF} \text{ (dB}\mu\text{V)} - I_{L1} \text{ (dB)} + 6$

$V_{oIF3} \text{ (dB}\mu\text{V)} = V_{oIF} \text{ (dB}\mu\text{V)} - I_{L2} \text{ (dB)} + 6$

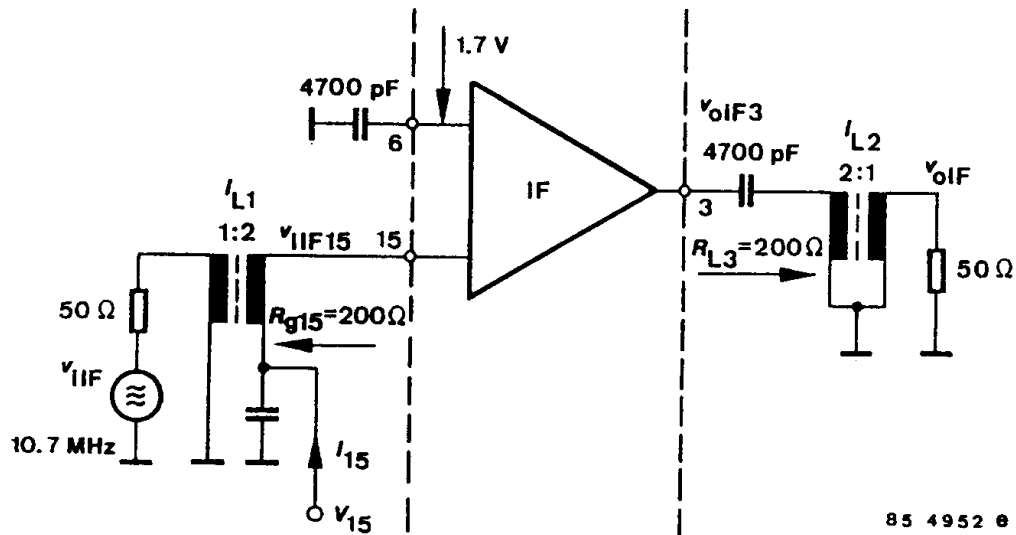
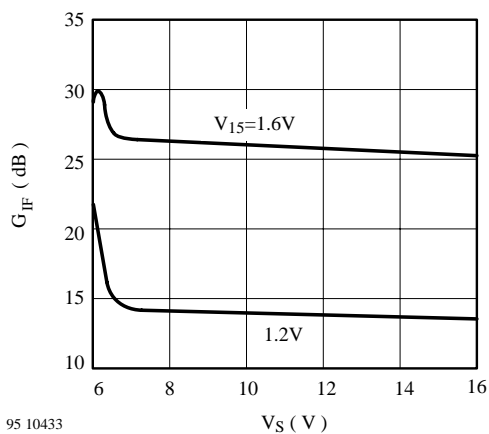
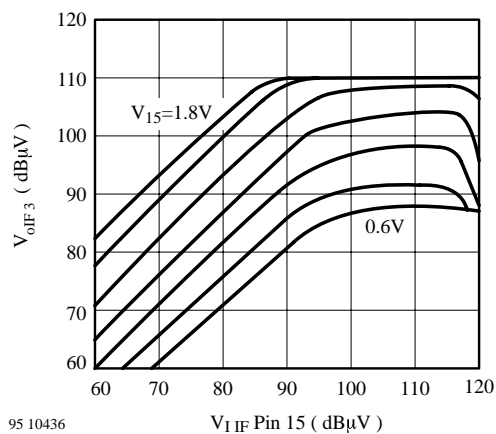

Figure 32. Test circuit



95 10433

Figure 33. G_{IF} vs. V_S



95 10436

Figure 36. V_{OIF3} vs. V_{1IF} Pin 15

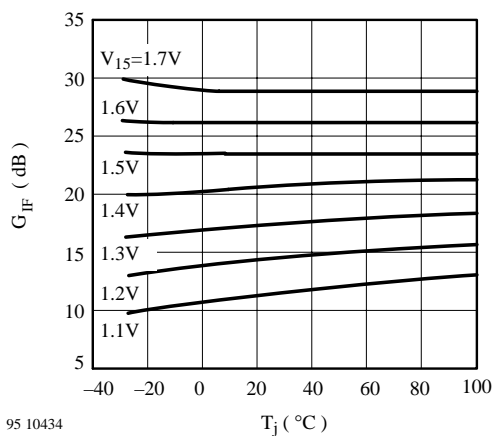

95 10434

Figure 34. G_{IF} vs. T_j

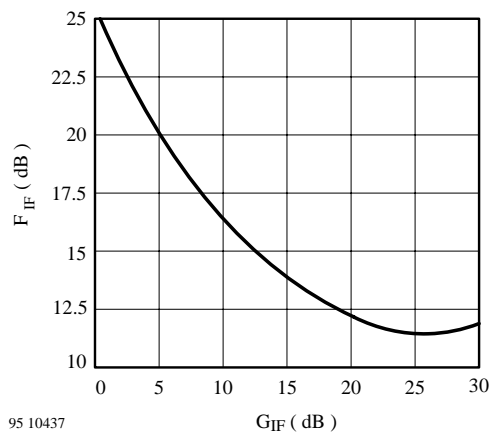

95 10437

Figure 37. F_{IF} vs. G_{IF}

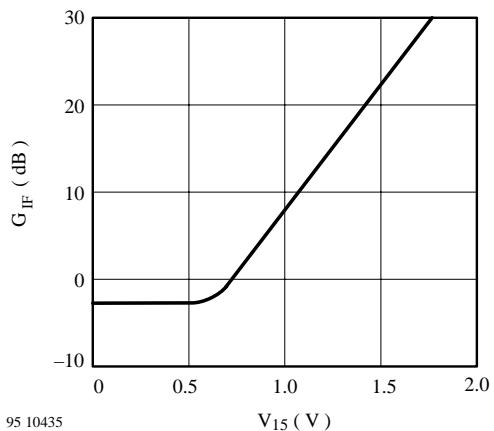

95 10435

Figure 35. G_{IF} vs. V_{15}

Reference Voltage

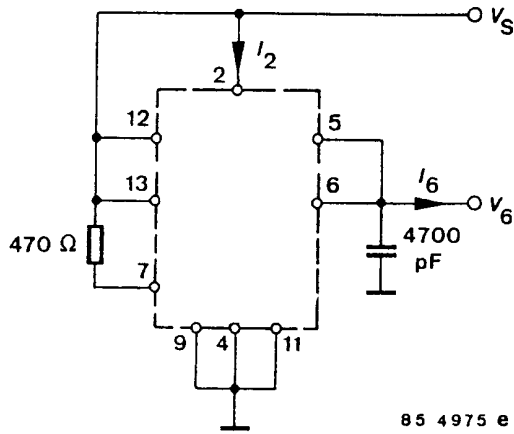
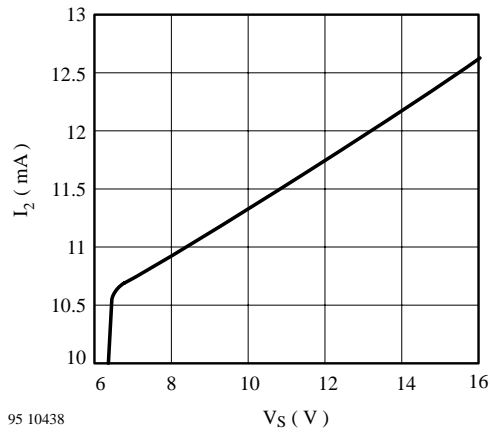
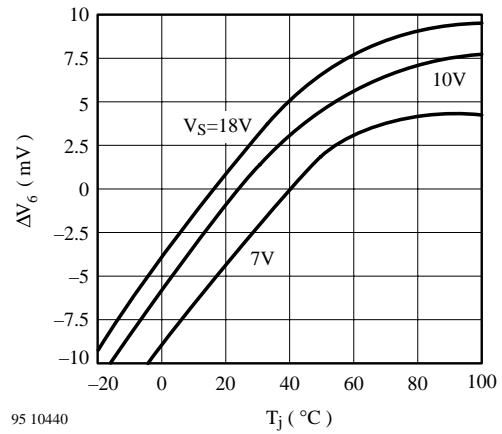

Figure 38. Test circuit



95 10438

Figure 39. I_2 vs. V_S



95 10440

Figure 41. ΔV_6 vs. T_j

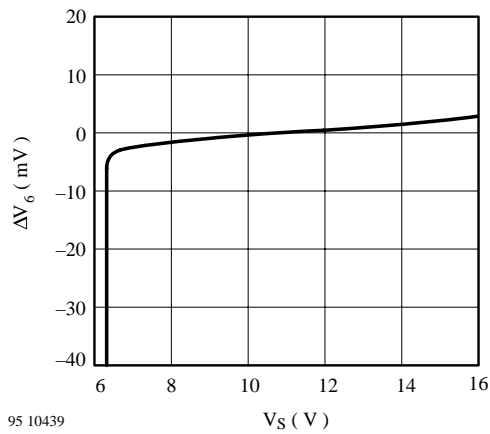

95 10439

Figure 40. ΔV_6 vs. V_S

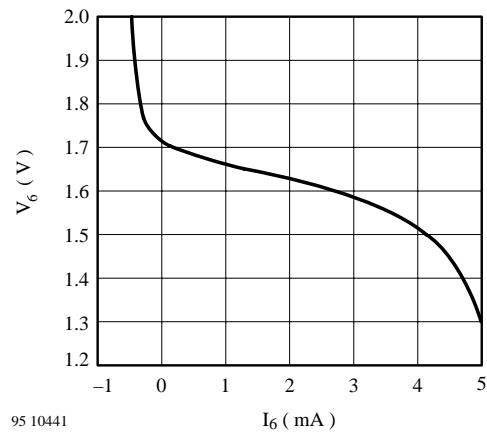

95 10441

Figure 42. V_6 vs. I_6

Application Circuit

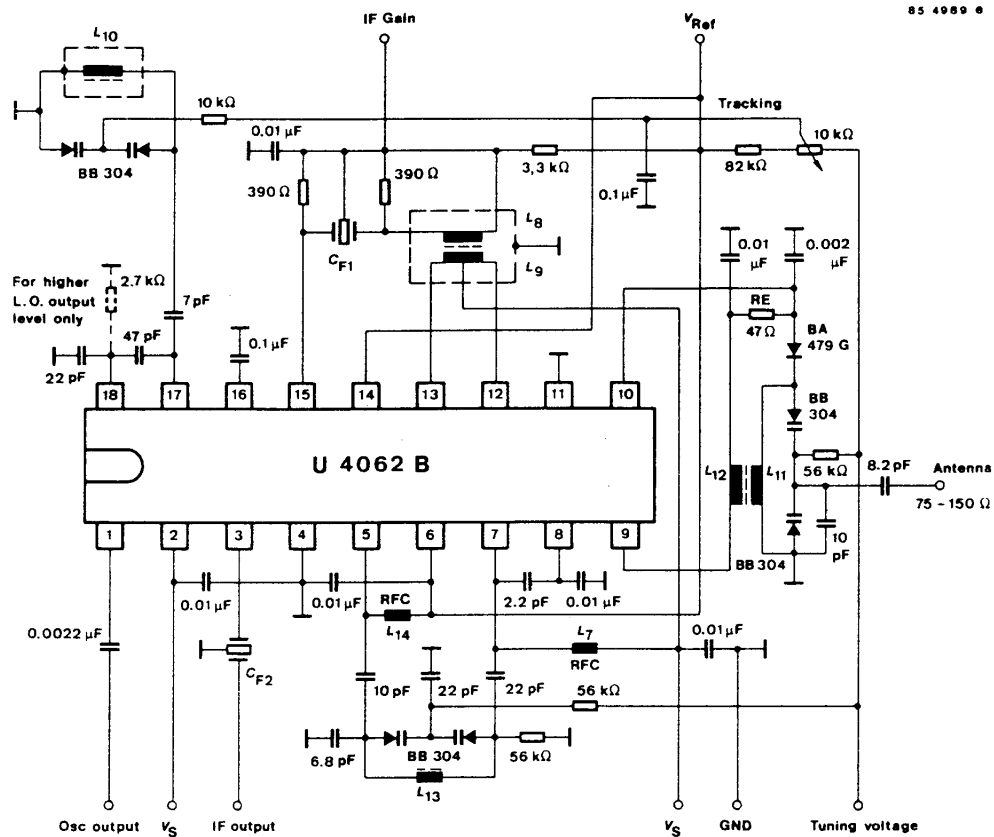

Circuit (section) from above diagram with keyed AGC

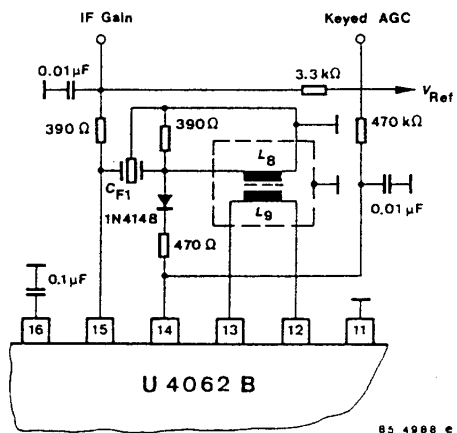

Figure 43. Typical Application circuit for high performance FM front end using non-repetitive alignment concept

Coils Specifications

L ₈ /L ₉	Toko 7 PL9/ (18 + 18) turns Nr. 218 ANS – 788 N
L ₁₀	Toko 7 K1 3 turns Nr. 291 ENS – 2054 IB or Toko MC 122 Nr. E528 SNAS – 100075
L ₁₁ /L ₁₂	Toko 7 K1 without case 4/8 turns Nr. 291 ENF – 2342 x
L ₁₃	Toko 7 K1 4 turns Nr. 291 ENS – 2341 IB or Toko MC 122 Nr. E528 SNAS – 100076
L ₁₄ /L ₁₇	Choke 1.5 μH Toko 348 LS – 1R5 or similar
CF1; CF2	Toko CFSK – 107M3 or similar

V_S = 8.5 V, T_{amb} = 25°C

Electrical Connections	Pin DIP18	Voltage (DC) in V
LO output	1	1.73
V _S	2	8.5
IF output	3	6.1
Ground	4	0
Mixer input	5	1.7
Reference output voltage	6	1.7
RF preamplifier (collector)	7	8.5
RF preamplifier (base)	8	1.3
RF preamplifier (emitter)	9	0.53
AGC output	10	0.07
Ground	11	0
Mixer output	12	8.5
Mixer output	13	8.5
AGC input	14	1.7
IF input, IF gain control	15	1.54
AGC time constant	16	1.06
LO (base)	17	3.2
LO (emitter)	18	2.51

FM Front End Data Using Application Circuit

Antenna impedance 75 Ω, Z_{load} IF = 330 Ω, V_S = 8.5 V, T_{amb} = 25°C

Characteristics	Symbol	Min.	Typ.	Max.	Unit
Supply current	I _S		32		mA
Tuning range	f	88		108	MHz
Tuning voltage – at 88 MHz (equal IC's reference voltage) – at 108 MHz	V _{tune} V _{tune}		1.7 6.5		V V
Center IF	f		10.7*		MHz
IF output bandwidth at –3 dB	B _{IF}		130*		kHz
Power gain	G		46*		dB
Gain variation versus the band	ΔG		1		dB
Noise figure	NF		6		dB
Image rejection		57	70		dB
RF intermodulation			70		dB
1/2 IF rejection			90		dB
Spurious response, second osc. harmonic			90		dB
IF rejection		85			dB
Osc. output voltage at 520 Ω load	V _{OSC}		200		mV

* Depending on ceramic IF filters to be used

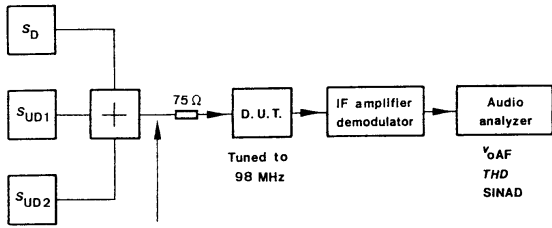

$V_{iD}(f_D)$ = Desired signal (EMF)
 $V_{iUD1}(f_{UD1})$
 $V_{iUD2}(f_{UD2})$ } = Undesired signals (EMF)

Figure 44. Block diagram of the test set up

Test conditions

- De-emphasis - 75 μ s
- AF bandwidth 30 to 20 kHz
- RMS, unweighted

Setup for one signal measurement

- $f_D = 98$ MHz

Note: V_{oAF} related to 75 kHz dev., 1 kHz, $V_{iD} = 66$ dB μ V

Setup for three signals intermodulation measurement

- S_D : $f_D = 98$ MHz, FM: 1 kHz, 22.5 kHz dev.
- S_{UD1} : FM: 0.15 kHz, 22.5 kHz dev.
- S_{UD2} : Unmodulated
- V_{iD} : for 35 dB SINAD

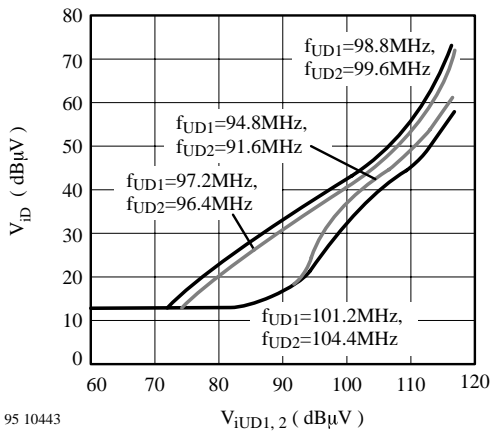

95 10443

Figure 45. V_{iD} vs. $V_{iUD1,2}$

V_{iD} = input desired, V_{iUD} = input undesired

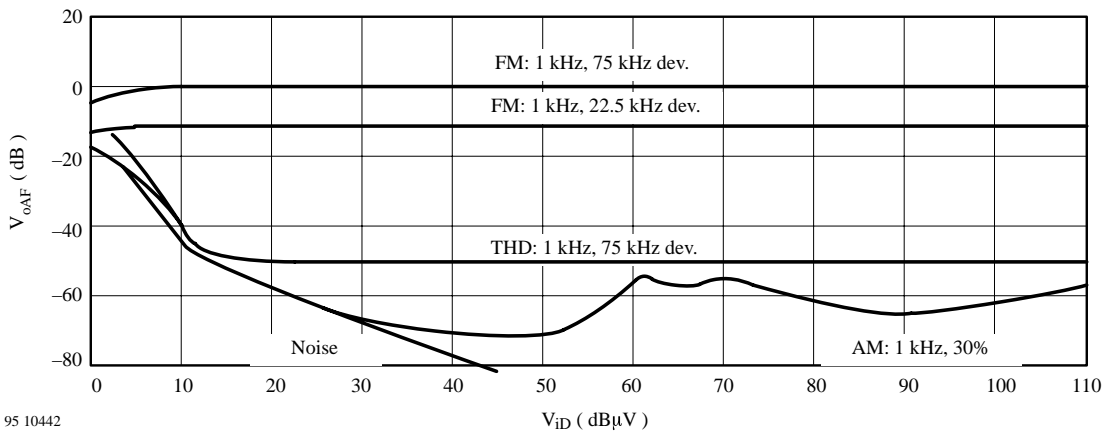

95 10442

Figure 46. V_{oAF} vs. V_{iD}

Package Information

Package DIP18

Dimensions in mm

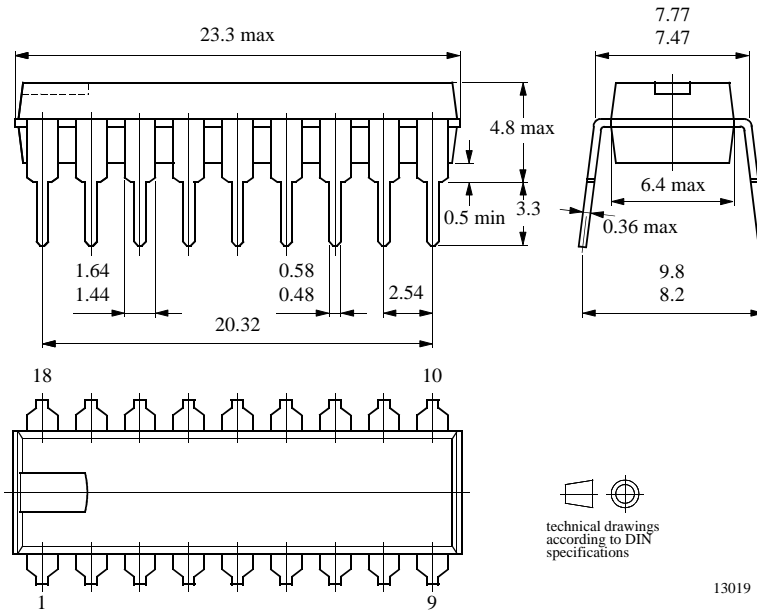

Ozone Depleting Substances Policy Statement

It is the policy of **TEMIC Semiconductor GmbH** to

1. Meet all present and future national and international statutory requirements.
2. Regularly and continuously improve the performance of our products, processes, distribution and operating systems with respect to their impact on the health and safety of our employees and the public, as well as their impact on the environment.

It is particular concern to control or eliminate releases of those substances into the atmosphere which are known as ozone depleting substances (ODSs).

The Montreal Protocol (1987) and its London Amendments (1990) intend to severely restrict the use of ODSs and forbid their use within the next ten years. Various national and international initiatives are pressing for an earlier ban on these substances.

TEMIC Semiconductor GmbH has been able to use its policy of continuous improvements to eliminate the use of ODSs listed in the following documents.

1. Annex A, B and list of transitional substances of the Montreal Protocol and the London Amendments respectively
2. Class I and II ozone depleting substances in the Clean Air Act Amendments of 1990 by the Environmental Protection Agency (EPA) in the USA
3. Council Decision 88/540/EEC and 91/690/EEC Annex A, B and C (transitional substances) respectively.

TEMIC Semiconductor GmbH can certify that our semiconductors are not manufactured with ozone depleting substances and do not contain such substances.

We reserve the right to make changes to improve technical design and may do so without further notice.

Parameters can vary in different applications. All operating parameters must be validated for each customer application by the customer. Should the buyer use TEMIC Semiconductors products for any unintended or unauthorized application, the buyer shall indemnify TEMIC Semiconductors against all claims, costs, damages, and expenses, arising out of, directly or indirectly, any claim of personal damage, injury or death associated with such unintended or unauthorized use.

TEMIC Semiconductor GmbH, P.O.B. 3535, D-74025 Heilbronn, Germany
Telephone: 49 (0)7131 67 2594, Fax number: 49 (0)7131 67 2423