

LP5900

Ultra Low Noise, 150 mA Linear Regulator for RF/Analog Circuits Requires No Bypass Capacitor

General Description

The LP5900 is a linear regulator capable of supplying 150 mA output current. Designed to meet the requirements of RF/Analog circuits, the LP5900 device provides low noise, high PSRR, low quiescent current, and low line transient response figures. Using new innovative design techniques the LP5900 offers class-leading device noise performance without a noise bypass capacitor.

The device is designed to work with 0.47 μ F input and output ceramic capacitors. (No Bypass Capacitor is required)

The device is available in micro SMD package and LLP package. For all other package options contact your local NSC sales office.

This device is available with 1.5V, 1.575V, 1.8V, 1.9V, 2.0V, 2.1V, 2.2V, 2.5V, 2.6V, 2.7V, 2.75V, 2.8V, 2.85V, 3.0V, and 3.3V outputs. Please contact your local sales office for any other voltage options.

Features

- Stable with 0.47 μ F Ceramic Input and Output Capacitors
- No Noise Bypass Capacitor Required
- Logic Controlled Enable
- Thermal-overload and short-circuit protection
- -40°C to $+125^{\circ}\text{C}$ junction temperature range for operation

Key Specifications

■ Input voltage range	2.5V to 5.5V
■ Output voltage range	1.5V to 3.3V
■ Output current	150 mA
■ Low output voltage noise	6.5 μV_{RMS}
■ PSRR	75 dB at 1 kHz
■ Output voltage tolerance	$\pm 2\%$
■ Virtually zero I_{Q} (disabled)	$< 1 \mu\text{A}$
■ Very low I_{Q} (enabled)	25 μA
■ Start-up time	150 μs
■ Low dropout	80 mV typ.

Package

4-Bump micro SMD (lead free)	1.057 mm x 1.083 mm
6 Pin LLP (SC-70 footprint)	2.2 mm x 2.5 mm

Applications

- Cellular phones
- PDA handsets
- Wireless LAN devices

Typical Application Circuit

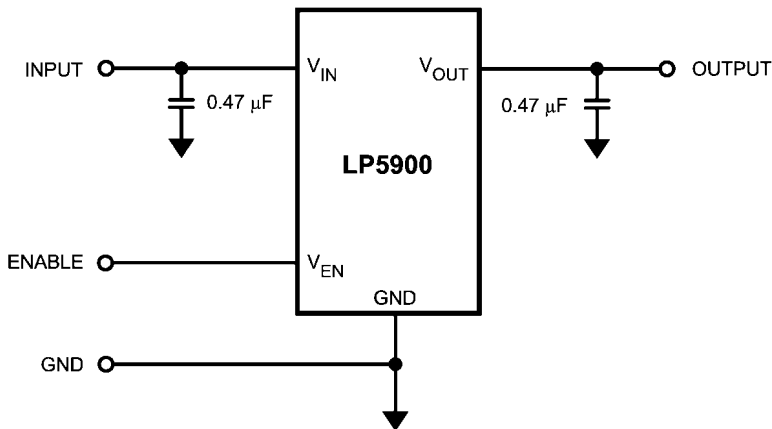

20144101

Connection Diagrams

4-Bump Thin micro SMD Package, Large Bump
NS Package Number TLA04

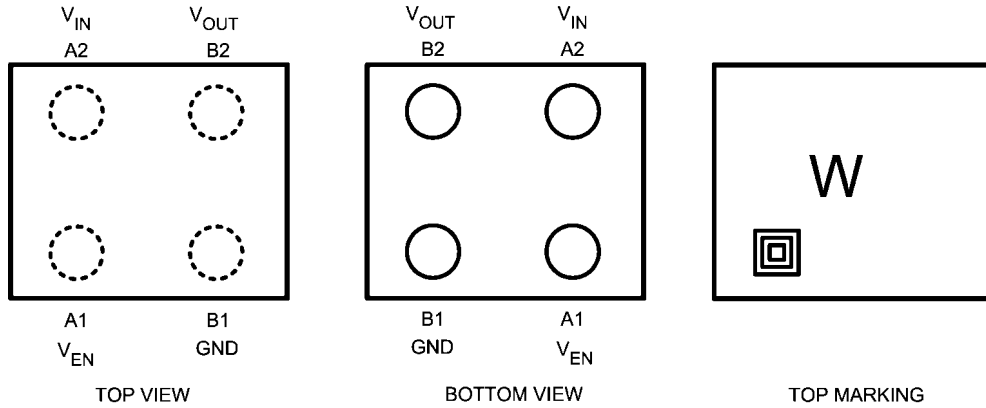

20144102

The actual physical placement of the package marking will vary from part to part.

LLP-6 Package
NS Package Number SDB06A

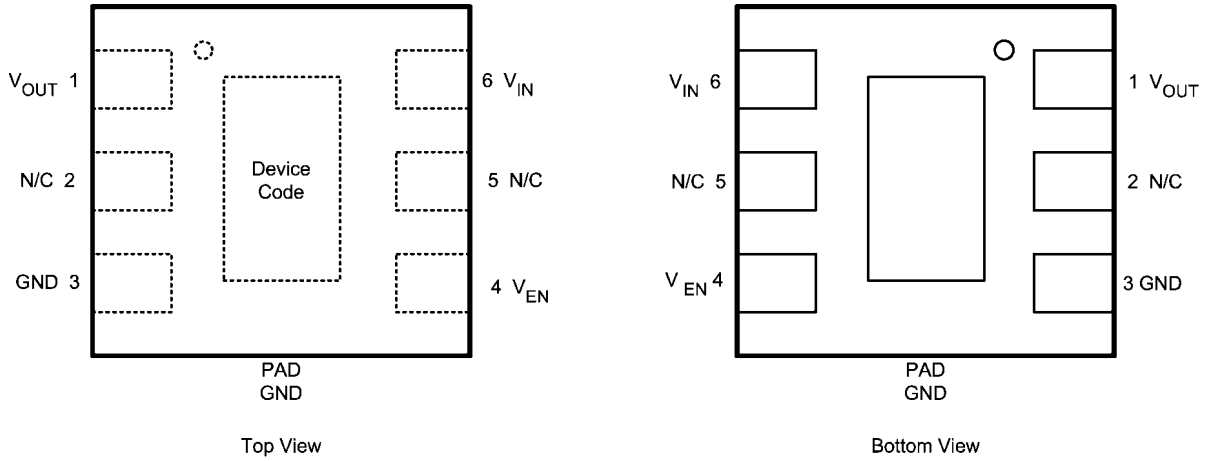

20144106

Pin Descriptions

Pin No.		Symbol	Name and Function
micro SMD	LLP		
A1	4	V_{EN}	Enable input; disables the regulator when $\leq 0.4V$. Enables the regulator when $\geq 1.2V$. An internal $1 M\Omega$ pulldown resistor connects this input to ground.
B1	3	GND	Common ground
B2	1	V_{OUT}	Output voltage. A $0.47 \mu F$ Low ESR capacitor should be connected to this Pin. Connect this output to the load circuit.
A2	6	V_{IN}	Input voltage supply. A $0.47 \mu F$ capacitor should be connected at this input.
	Pad	GND	Common Ground. Connect to Pin 3.

Ordering Information

micro SMD Package (Lead Free)

Output Voltage (V)	Supplied As		Package Marking
	250 Units Tape and Reel	3k Units Tape and Reel	
1.5	LP5900TL-1.5/NOPB	LP5900TLX-1.5/NOPB	
1.575	LP5900TL-1.575/NOPB	LP5900TLX-1.575/NOPB	
1.8	LP5900TL-1.8/NOPB	LP5900TLX-1.8/NOPB	
1.9	LP5900TL-1.9/NOPB	LP5900TLX-1.9/NOPB	
2.0	LP5900TL-2.0/NOPB	LP5900TLX-2.0/NOPB	
2.1	LP5900TL-2.1/NOPB	LP5900TLX-2.1/NOPB	
2.2	LP5900TL-2.2/NOPB	LP5900TLX-2.2/NOPB	
2.5	LP5900TL-2.5/NOPB	LP5900TLX-2.5/NOPB	
2.6	LP5900TL-2.6/NOPB	LP5900TLX-2.6/NOPB	
2.7	LP5900TL-2.7/NOPB	LP5900TLX-2.7/NOPB	
2.75	LP5900TL-2.75/NOPB	LP5900TLX-2.75/NOPB	
2.8	LP5900TL-2.8/NOPB	LP5900TLX-2.8/NOPB	
2.85	LP5900TL-2.85/NOPB	LP5900TLX-2.85/NOPB	
3.0	LP5900TL-3.0/NOPB	LP5900TLX-3.0/NOPB	
3.3	LP5900TL-3.3/NOPB	LP5900TLX-3.3/NOPB	

** For availability contact National Semiconductor local sales office

For LLP-6 Package

Output Voltage (V)	Supplied As		Package Marking
	250 Units Tape and Reel	3k Units Tape and Reel	
1.5	LP5900SD-1.5/NOPB	LP5900SDX-1.5/NOPB	L15
1.8	LP5900SD-1.8/NOPB	LP5900SDX-1.8/NOPB	L17
2.0	LP5900SD-2.0/NOPB	LP5900SDX-2.0/NOPB	L18
2.2	LP5900SD-2.2/NOPB	LP5900SDX-2.2/NOPB	L19
2.5	LP5900SD-2.5/NOPB	LP5900SDX-2.5/NOPB	L13
2.7	LP5900SD-2.7/NOPB	LP5900SDX-2.7/NOPB	L14
2.8	LP5900SD-2.8/NOPB	LP5900SDX-2.8/NOPB	L12
3.0	LP5900SD-3.0/NOPB	LP5900SDX-3.0/NOPB	L20
3.3	LP5900SD-3.3/NOPB	LP5900SDX-3.3/NOPB	L16

Absolute Maximum Ratings (Notes 1, 2)

If Military/Aerospace specified devices are required, please contact the National Semiconductor Sales Office/Distributors for availability and specifications.

V_{IN} Pin: Input Voltage	-0.3 to 6.0V
V_{OUT} Pin: Output Voltage	-0.3 to ($V_{IN} + 0.3V$) to 6.0V (max)
V_{EN} Pin: Enable Input Voltage	-0.3 to ($V_{IN} + 0.3V$) to 6.0V (max)
Continuous Power Dissipation (Note 3)	Internally Limited
Junction Temperature (T_{JMAX})	150°C
Storage Temperature Range	-65 to 150°C
Maximum Lead Temperature (Soldering, 10 sec.)	260°C
ESD Rating (Note 4)	

Human Body Model	2 kV
Machine Model	200V

Operating Ratings (Note 1), (Note 2)

V_{IN} : Input Voltage Range	2.5V to 5.5V
V_{EN} : Enable Voltage Range	0 to ($V_{IN} + 0.3V$) to 5.5V (max)
Recommended Load Current (Note 5)	0 to 150 mA
Junction Temperature Range (T_J)	-40°C to +125°C
Ambient Temperature Range (T_A) (Note 5)	-40°C to +85°C

Thermal Properties

Junction to Ambient Thermal Resistance θ_{JA} (Note 6)	
JEDEC Board (microSMD) (Note 16)	88°C/W
4L Cellphone Board (microSMD)	157.4°C/W
JEDEC Board (LLP-6)(Note 16)	77.3°C/W

Electrical Characteristics

Limits in standard typeface are for $T_A = 25^\circ\text{C}$. Limits in **boldface** type apply over the full operating junction temperature range (-40°C $\leq T_J \leq$ +125°C). Unless otherwise noted, specifications apply to the LP5900 Typical Application Circuit (pg. 1) with: $V_{IN} = V_{OUT(NOM)} + 1.0V$, $V_{EN} = 1.2V$, $C_{IN} = C_{OUT} = 0.47 \mu\text{F}$, $I_{OUT} = 1.0 \text{ mA}$. (Note 2), (Note 7)

Symbol	Parameter	Conditions	Min	Typ	Max	Units
V_{IN}	Input Voltage		2.5		5.5	V
ΔV_{OUT}	Output Voltage Tolerance	$V_{IN} = (V_{OUT(NOM)} + 1.0V)$ to 5.5V, $I_{OUT} = 1 \text{ mA}$ to 150mA	-2		2	%
	Line Regulation	$V_{IN} = (V_{OUT(NOM)} + 1.0V)$ to 5.5V, $I_{OUT} = 1 \text{ mA}$		0.05		%/V
	Load Regulation	$I_{OUT} = 1 \text{ mA}$ to 150 mA		0.001		%/mA
I_{LOAD}	Load Current	(Note 9)	0			mA
	Maximum Output Current		150			
I_Q	Quiescent Current (Note 11)	$V_{EN} = 1.2V$, $I_{OUT} = 0 \text{ mA}$		25	50	μA
		$V_{EN} = 1.2V$, $I_{OUT} = 150 \text{ mA}$		160	230	
		$V_{EN} = 0.3V$ (Disabled)		0.003	1.0	
I_G	Ground Current (Note 13)	$I_{OUT} = 0 \text{ mA}$ ($V_{OUT} = 2.5V$)		30		μA
V_{DO}	Dropout Voltage (Note 10)	$I_{OUT} = 150 \text{ mA}$		80	150	mV
I_{SC}	Short Circuit Current Limit	(Note 12)		300		mA
PSRR	Power Supply Rejection Ratio (Note 15)	$f = 100 \text{ Hz}$, $I_{OUT} = 150 \text{ mA}$		85		dB
		$f = 1 \text{ kHz}$, $I_{OUT} = 150 \text{ mA}$		75		
		$f = 10 \text{ kHz}$, $I_{OUT} = 150 \text{ mA}$		65		
		$f = 50 \text{ kHz}$, $I_{OUT} = 150 \text{ mA}$		52		
		$f = 100 \text{ kHz}$, $I_{OUT} = 150 \text{ mA}$		40		
e_n	Output Noise Voltage (Note 15)	BW = 10 Hz to 100 kHz, $V_{IN} = 4.2V$	$I_{OUT} = 0 \text{ mA}$	7		μV_{RMS}
			$I_{OUT} = 1 \text{ mA}$	10		
			$I_{OUT} = 150 \text{ mA}$	6.5		
$T_{SHUTDOWN}$	Thermal Shutdown	Temperature		160		°C
		Hysteresis		20		

Symbol	Parameter	Conditions	Min	Typ	Max	Units
Login Input Thresholds						
V_{IL}	Low Input Threshold (V_{EN})	$V_{IN} = 2.5V$ to $5.5V$			0.4	V
V_{IH}	High Input Threshold (V_{EN})	$V_{IN} = 2.5V$ to $5.5V$	1.2			V
I_{EN}	Input Current at V_{EN} Pin (Note 14)	$V_{EN} = 5.5V$ and $V_{IN} = 5.5V$		5.5		μA
		$V_{EN} = 0.0V$ and $V_{IN} = 5.5V$		0.001		
Transient Characteristics						
ΔV_{OUT}	Line Transient (Note 15)	$V_{IN} = (V_{OUT(NOM)} + 1.0V)$ to $(V_{OUT(NOM)} + 1.6V)$ in $30 \mu s$, $I_{OUT} = 1 mA$	-2			mV
		$V_{IN} = (V_{OUT(NOM)} + 1.6V)$ to $(V_{OUT(NOM)} + 1.0V)$ in $30 \mu s$, $I_{OUT} = 1 mA$			2	
	Load Transient (Note 15)	$I_{OUT} = 1 mA$ to $150 mA$ in $10 \mu s$	-110			mV
		$I_{OUT} = 150 mA$ to $1 mA$ in $10 \mu s$			50	
Overshoot on Startup (Note 15)					20	mV
	Turn on Time	To 95% of $V_{OUT(NOM)}$		150	300	μs

Note 1: Absolute Maximum Ratings indicate limits beyond which damage to the component may occur. Operating Ratings are conditions under which operation of the device is guaranteed. Operating Ratings do not imply guaranteed performance limits. For guaranteed performance limits and associated test conditions, see the Electrical Characteristics tables.

Note 2: All voltages are with respect to the potential at the GND pin.

Note 3: Internal thermal shutdown circuitry protects the device from permanent damage.

Note 4: The Human body model is a 100 pF capacitor discharged through a 1.5 k Ω resistor into each pin. The machine model is a 200 pF capacitor discharged directly into each pin. MIL-STD-883 3015.7

Note 5: In applications where high power dissipation and/or poor package thermal resistance is present, the maximum ambient temperature may have to be derated. Maximum ambient temperature (T_{A-MAX}) is dependent on the maximum operating junction temperature ($T_{J-MAX-OP} = 125^{\circ}C$), the maximum power dissipation of the device in the application (P_{D-MAX}), and the junction-to ambient thermal resistance of the part/package in the application (θ_{JA}), as given by the following equation: $T_{A-MAX} = T_{J-MAX-OP} - (\theta_{JA} \times P_{D-MAX})$. See applications section.

Note 6: Junction-to-ambient thermal resistance is highly application and board-layout dependent. In applications where high maximum power dissipation exists, special care must be paid to thermal dissipation issues in board design.

Note 7: Min and Max limits are guaranteed by design, test, or statistical analysis. Typical numbers are not guaranteed, but do represent the most likely norm.

Note 8: C_{IN} , C_{OUT} : Low-ESR Surface-Mount Ceramic Capacitors (MLCCs) used in setting electrical characteristics.

Note 9: The device maintains a stable, regulated output voltage without a load current.

Note 10: Dropout voltage is the voltage difference between the input and the output at which the output voltage drops to 100 mV below its nominal value. This parameter only applies to output voltages above 2.5V.

Note 11: Quiescent current is defined here as the difference in current between the input voltage source and the load at V_{OUT} .

Note 12: Short Circuit Current is measured with V_{OUT} pulled to 0v and V_{IN} worst case = 6.0V.

Note 13: Ground current is defined here as the total current flowing to ground as a result of all input voltages applied to the device.

Note 14: There is a 1 M Ω resistor between V_{EN} and ground on the device.

Note 15: This specification is guaranteed by design.

Note 16: Detailed description of the board can be found in JESD51-7

Output & Input Capacitor, Recommended Specifications

Symbol	Parameter	Conditions	Min	Nom	Max	Units
C_{IN}	Input Capacitance	Capacitance for stability	0.33	0.47	10	μF
C_{OUT}	Output Capacitance					
ESR	Output/Input Capacitance		5		500	m Ω

Note: The minimum capacitance should be greater than 0.33 μF over the full range of operating conditions. The capacitor tolerance should be 30% or better over the full temperature range. The full range of operating conditions for the capacitor in the application should be considered during device selection to ensure this minimum capacitance specification is met. X7R capacitors are recommended however capacitor types X5R, Y5V and Z5U may be used with consideration of the application and conditions.

Typical Performance Characteristics. Unless otherwise specified, $C_{IN} = C_{OUT} = 0.47\mu F$, $V_{IN} = V_{OUT(NOM)} + 1.0V$, $V_{EN} = 1.2V$, $I_{OUT} = 1mA$, $T_A = 25^\circ C$.

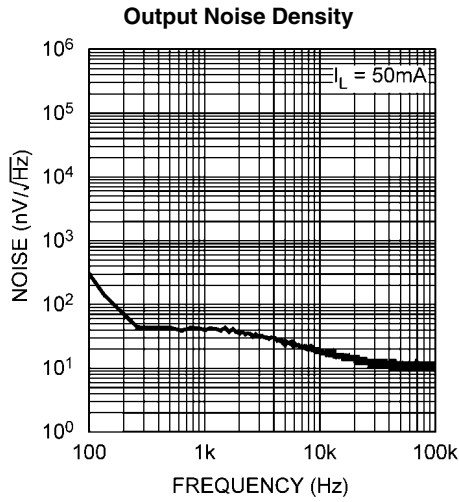

20144157

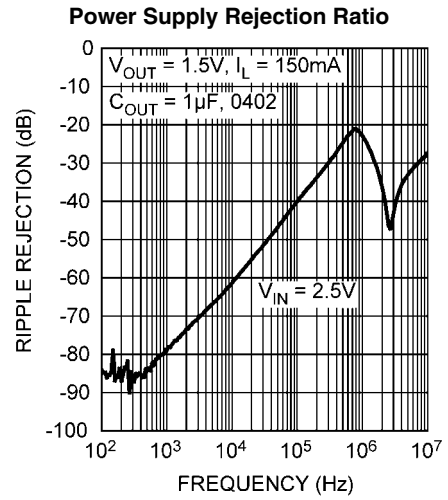

20144158

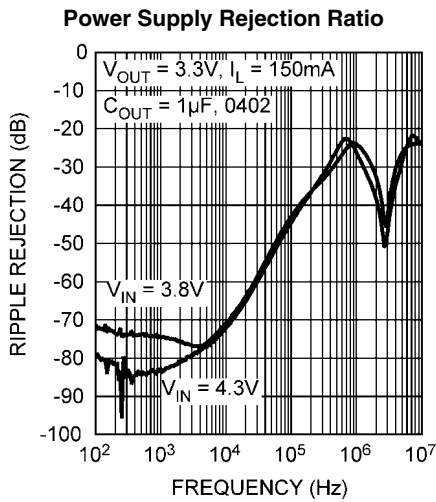

20144159

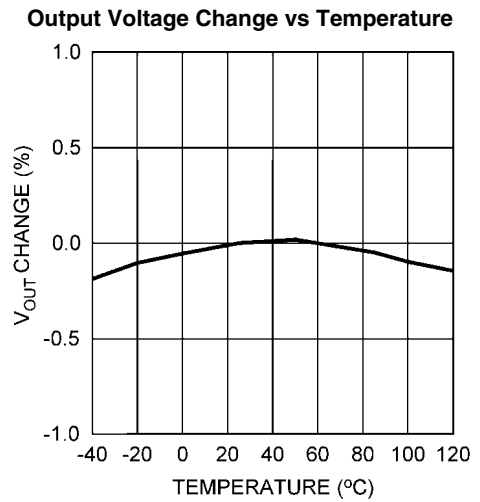

20144154

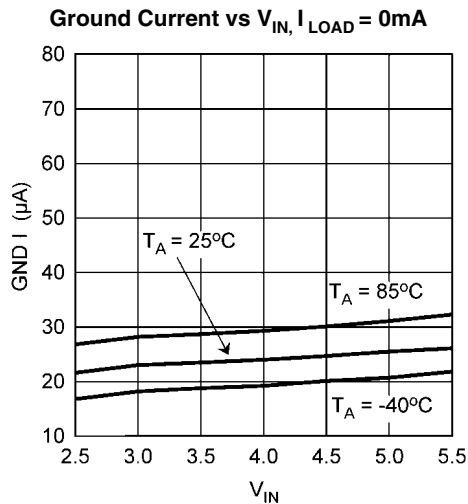

20144151

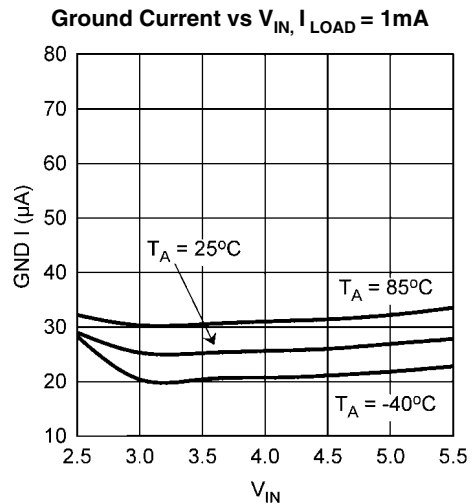

20144152

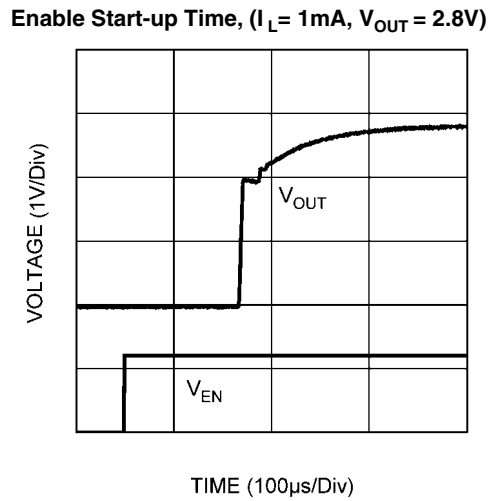
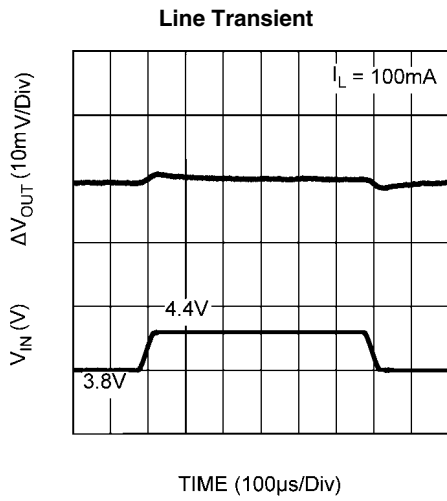
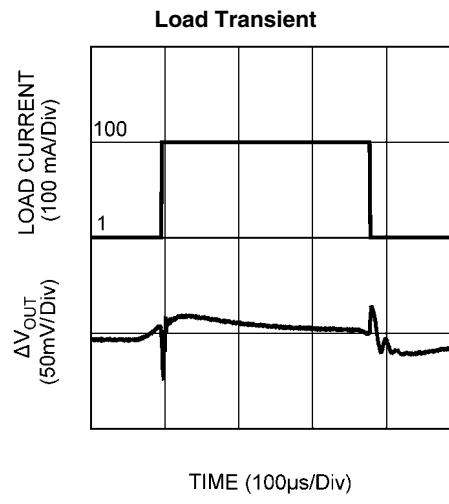
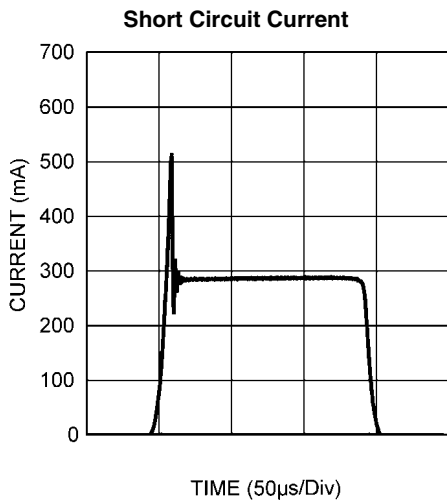
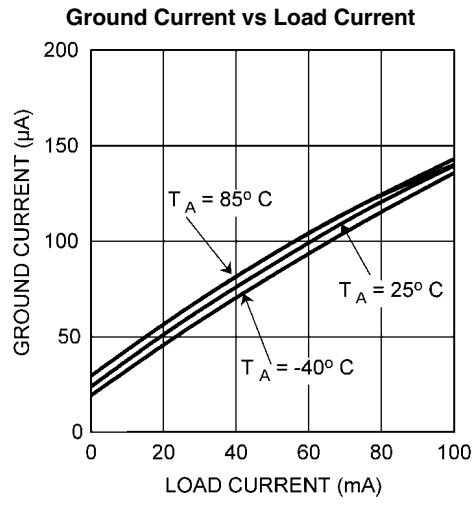
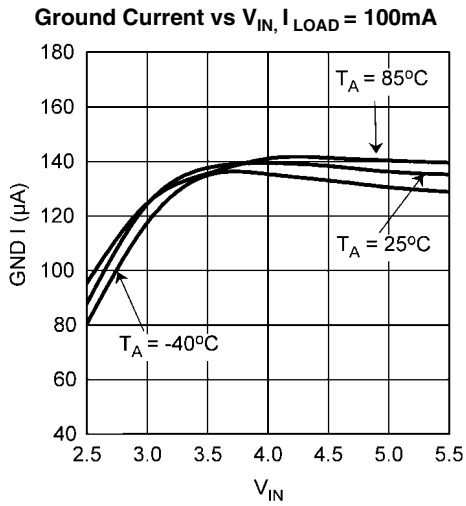

Enable Start-up Time, ($I_L = 100\text{mA}$, $V_{OUT} = 2.8\text{V}$)

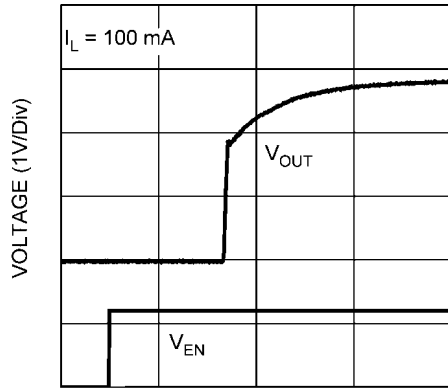

TIME (100 $\mu\text{s/Div}$)

20144145

Enable Start-up Time, ($I_L = 1\text{mA}$, $V_{OUT} = 2.8\text{V}$)

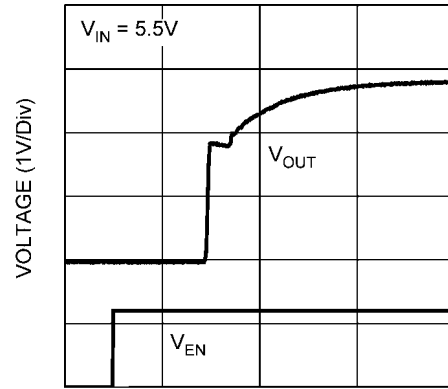

TIME (100 $\mu\text{s/Div}$)

20144146

Enable Start-up Time, ($I_L = 100\text{mA}$, $V_{OUT} = 2.8\text{V}$)

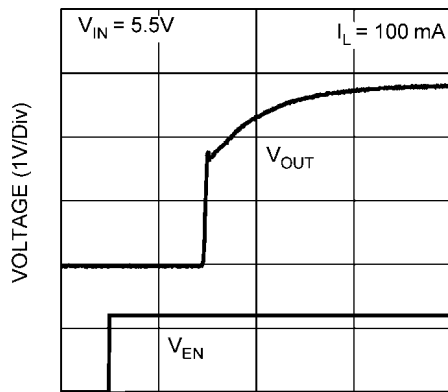

TIME (100 $\mu\text{s/Div}$)

20144147

Dropout Over Temperature (100mA)

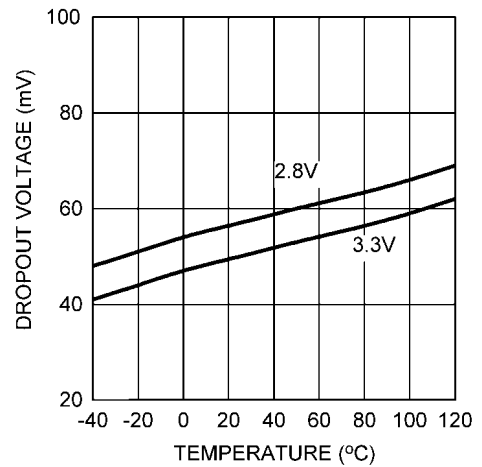

20144105

Application Hints

POWER DISSIPATION AND DEVICE OPERATION

The permissible power dissipation for any package is a measure of the capability of the device to pass heat from the power source, the junctions of the IC, to the ultimate heat sink, the ambient environment. Thus the power dissipation is dependent on the ambient temperature and the thermal resistance across the various interfaces between the die and ambient air. As stated in (Note 5) of the electrical characteristics, the allowable power dissipation for the device in a given package can be calculated using the equation:

$$P_D = \frac{(T_{JMAX} - T_A)}{\theta_{JA}}$$

The actual power dissipation across the device can be represented by the following equation:

$$P_D = (V_{IN} - V_{OUT}) \times I_{OUT}$$

This establishes the relationship between the power dissipation allowed due to thermal consideration, the voltage drop across the device, and the continuous current capability of the

device. These two equations should be used to determine the optimum operating conditions for the device in the application.

EXTERNAL CAPACITORS

Like any low-dropout regulator, the LP5900 requires external capacitors for regulator stability. The LP5900 is specifically designed for portable applications requiring minimum board space and smallest components. These capacitors must be correctly selected for good performance.

INPUT CAPACITOR

An input capacitor is required for stability. The input capacitor should be at least equal to or greater than the output capacitor. It is recommended that a 0.47 μF capacitor be connected between the LP5900 input pin and ground.

This capacitor must be located a distance of not more than 1 cm from the input pin and returned to a clean analogue ground. Any good quality ceramic, tantalum, or film capacitor may be used at the input.

Important: To ensure stable operation it is essential that good PCB practices are employed to minimize ground impedance and keep input inductance low. If these conditions cannot be met, or if long leads are to be used to connect the battery or other power source to the LP5900, then it is recommended to increase the input capacitor to at least 2.2 μF .

Also, tantalum capacitors can suffer catastrophic failures due to surge current when connected to a low-impedance source of power (like a battery or a very large capacitor). If a tantalum capacitor is used at the input, it must be guaranteed by the manufacturer to have a surge current rating sufficient for the application. There are no requirements for the ESR (Equivalent Series Resistance) on the input capacitor, but tolerance and temperature coefficient must be considered when selecting the capacitor to ensure the capacitance will remain $0.47 \mu\text{F} \pm 30\%$ over the entire operating temperature range.

OUTPUT CAPACITOR

The LP5900 is designed specifically to work with very small ceramic output capacitors. A ceramic capacitor (dielectric types X5R or X7R) in the $0.47 \mu\text{F}$ to $10 \mu\text{F}$ range, and with ESR between $5 \text{ m}\Omega$ to $500 \text{ m}\Omega$, is suitable in the LP5900 application circuit. For this device the output capacitor should be connected between the V_{OUT} pin and a good ground connection and should be mounted within 1 cm of the device.

It may also be possible to use tantalum or film capacitors at the device output, V_{OUT} , but these are not as attractive for reasons of size and cost (see the section Capacitor Characteristics).

The output capacitor must meet the requirement for the minimum value of capacitance and have an ESR value that is within the range $5 \text{ m}\Omega$ to $500 \text{ m}\Omega$ for stability.

CAPACITOR CHARACTERISTICS

The LP5900 is designed to work with ceramic capacitors on the input and output to take advantage of the benefits they offer. For capacitance values in the range of $0.47 \mu\text{F}$ to $4.7 \mu\text{F}$, ceramic capacitors are the smallest, least expensive and have the lowest ESR values, thus making them best for eliminating high frequency noise. The ESR of a typical $0.47 \mu\text{F}$ ceramic capacitor is in the range of $20 \text{ m}\Omega$ to $40 \text{ m}\Omega$, which easily meets the ESR requirement for stability for the LP5900.

The temperature performance of ceramic capacitors varies by type and manufacturer. Most large value ceramic capacitors ($\geq 2.2 \mu\text{F}$) are manufactured with Z5U or Y5V temperature characteristics, which results in the capacitance dropping by more than 50% as the temperature goes from 25°C to 85°C .

A better choice for temperature coefficient in a ceramic capacitor is X7R. This type of capacitor is the most stable and holds the capacitance within $\pm 15\%$ over the temperature range. Tantalum capacitors are less desirable than ceramic for use as output capacitors because they are more expensive when comparing equivalent capacitance and voltage ratings in the $0.47 \mu\text{F}$ to $4.7 \mu\text{F}$ range.

Another important consideration is that tantalum capacitors have higher ESR values than equivalent size ceramics. This

means that while it may be possible to find a tantalum capacitor with an ESR value within the stable range, it would have to be larger in capacitance (which means bigger and more costly) than a ceramic capacitor with the same ESR value. It should also be noted that the ESR of a typical tantalum will increase about 2:1 as the temperature goes from 25°C down to -40°C , so some guard band must be allowed.

NO-LOAD STABILITY

The LP5900 will remain stable and in regulation with no external load.

ENABLE CONTROL

The LP5900 may be switched ON or OFF by a logic input at the ENABLE pin. A high voltage at this pin will turn the device on. When the enable pin is low, the regulator output is off and the device typically consumes 3 nA . However if the application does not require the shutdown feature, the V_{EN} pin can be tied to V_{IN} to keep the regulator output permanently on. In this case the supply voltage must be fully established $500 \mu\text{s}$ or less to ensure correct operation of the start-up circuit. Failure to comply with this condition may cause a delayed start-up time of several seconds.

A $1 \text{ M}\Omega$ pulldown resistor ties the V_{EN} input to ground, this ensures that the device will remain off when the enable pin is left open circuit. To ensure proper operation, the signal source used to drive the V_{EN} input must be able to swing above and below the specified turn-on/off voltage thresholds listed in the Electrical Characteristics section under V_{IL} and V_{IH} .

micro SMD MOUNTING

The micro SMD package requires specific mounting techniques, which are detailed in National Semiconductor Application Note AN-1112.

For best results during assembly, alignment ordinals on the PC board may be used to facilitate placement of the micro SMD device.

micro SMD LIGHT SENSITIVITY

Exposing the micro SMD device to direct light may cause incorrect operation of the device. Light sources such as halogen lamps can affect electrical performance if they are situated in proximity to the device.

Light with wavelengths in the red and infra-red part of the spectrum have the most detrimental effect thus the fluorescent lighting used inside most buildings has very little effect on performance.

Physical Dimensions inches (millimeters) unless otherwise noted

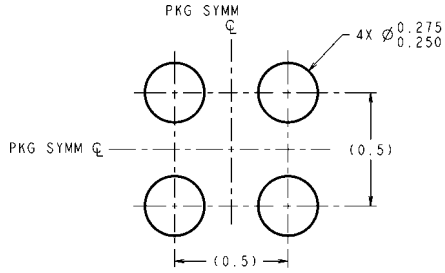

DIMENSIONS ARE IN MILLIMETERS
DIMENSIONS IN () FOR REFERENCE ONLY

LAND PATTERN RECOMMENDATION

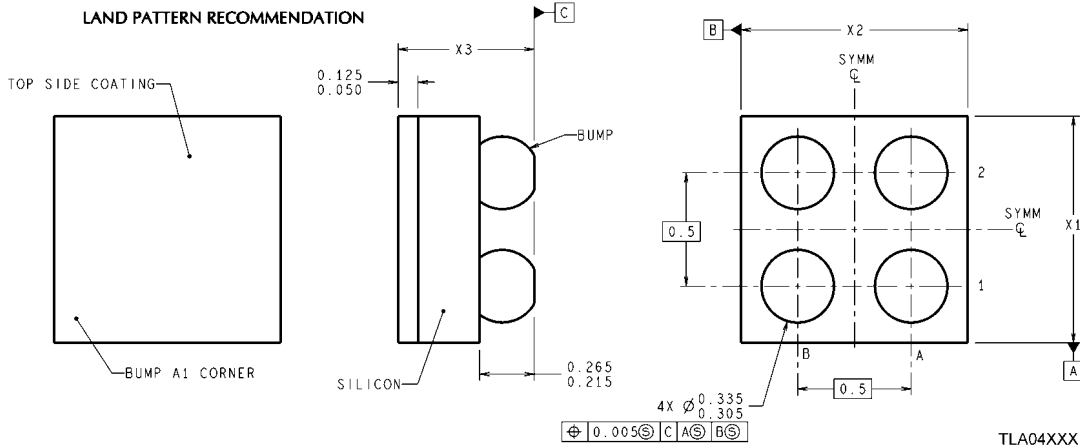

TLA04XXX (Rev D)

4-Bump Thin micro SMD
NS Package Number TLA04CDA
The dimensions for X1, X2 and X3 are given as:
X1 = 1.065 mm ± 0.030 mm
X2 = 1.090 mm ± 0.030 mm
X3 = 0.600 mm ± 0.075 mm

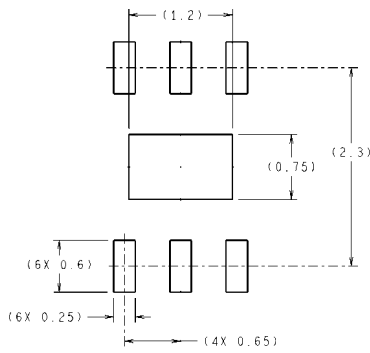

DIMENSIONS ARE IN MILLIMETERS
DIMENSIONS IN () FOR REFERENCE ONLY

RECOMMENDED LAND PATTERN

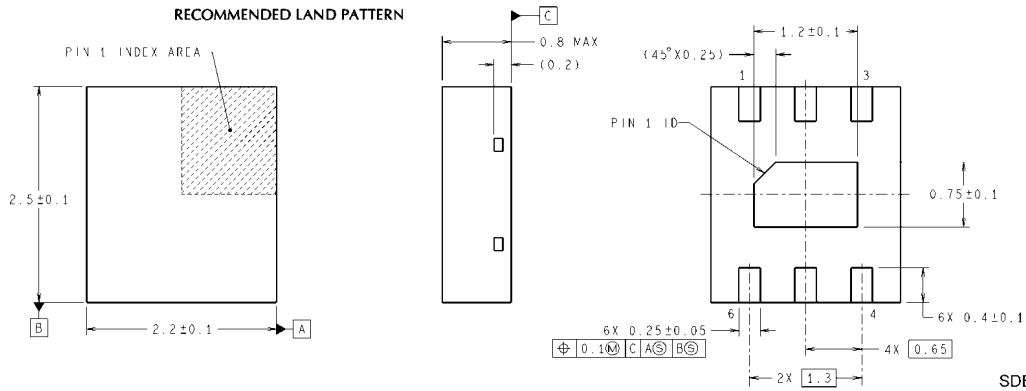

SDB06A (Rev A)

LLP, 6Lead Package (SC70 Land)
NS Package Number SDB06A

Notes

LP5900

Notes

THE CONTENTS OF THIS DOCUMENT ARE PROVIDED IN CONNECTION WITH NATIONAL SEMICONDUCTOR CORPORATION ("NATIONAL") PRODUCTS. NATIONAL MAKES NO REPRESENTATIONS OR WARRANTIES WITH RESPECT TO THE ACCURACY OR COMPLETENESS OF THE CONTENTS OF THIS PUBLICATION AND RESERVES THE RIGHT TO MAKE CHANGES TO SPECIFICATIONS AND PRODUCT DESCRIPTIONS AT ANY TIME WITHOUT NOTICE. NO LICENSE, WHETHER EXPRESS, IMPLIED, ARISING BY ESTOPPEL OR OTHERWISE, TO ANY INTELLECTUAL PROPERTY RIGHTS IS GRANTED BY THIS DOCUMENT.

TESTING AND OTHER QUALITY CONTROLS ARE USED TO THE EXTENT NATIONAL DEEMS NECESSARY TO SUPPORT NATIONAL'S PRODUCT WARRANTY. EXCEPT WHERE MANDATED BY GOVERNMENT REQUIREMENTS, TESTING OF ALL PARAMETERS OF EACH PRODUCT IS NOT NECESSARILY PERFORMED. NATIONAL ASSUMES NO LIABILITY FOR APPLICATIONS ASSISTANCE OR BUYER PRODUCT DESIGN. BUYERS ARE RESPONSIBLE FOR THEIR PRODUCTS AND APPLICATIONS USING NATIONAL COMPONENTS. PRIOR TO USING OR DISTRIBUTING ANY PRODUCTS THAT INCLUDE NATIONAL COMPONENTS, BUYERS SHOULD PROVIDE ADEQUATE DESIGN, TESTING AND OPERATING SAFEGUARDS.

EXCEPT AS PROVIDED IN NATIONAL'S TERMS AND CONDITIONS OF SALE FOR SUCH PRODUCTS, NATIONAL ASSUMES NO LIABILITY WHATSOEVER, AND NATIONAL DISCLAIMS ANY EXPRESS OR IMPLIED WARRANTY RELATING TO THE SALE AND/OR USE OF NATIONAL PRODUCTS INCLUDING LIABILITY OR WARRANTIES RELATING TO FITNESS FOR A PARTICULAR PURPOSE, MERCHANTABILITY, OR INFRINGEMENT OF ANY PATENT, COPYRIGHT OR OTHER INTELLECTUAL PROPERTY RIGHT.

LIFE SUPPORT POLICY

NATIONAL'S PRODUCTS ARE NOT AUTHORIZED FOR USE AS CRITICAL COMPONENTS IN LIFE SUPPORT DEVICES OR SYSTEMS WITHOUT THE EXPRESS PRIOR WRITTEN APPROVAL OF THE CHIEF EXECUTIVE OFFICER AND GENERAL COUNSEL OF NATIONAL SEMICONDUCTOR CORPORATION. As used herein:

Life support devices or systems are devices which (a) are intended for surgical implant into the body, or (b) support or sustain life and whose failure to perform when properly used in accordance with instructions for use provided in the labeling can be reasonably expected to result in a significant injury to the user. A critical component is any component in a life support device or system whose failure to perform can be reasonably expected to cause the failure of the life support device or system or to affect its safety or effectiveness.

National Semiconductor and the National Semiconductor logo are registered trademarks of National Semiconductor Corporation. All other brand or product names may be trademarks or registered trademarks of their respective holders.

Copyright© 2007 National Semiconductor Corporation

For the most current product information visit us at www.national.com



National Semiconductor Americas Customer Support Center
Email: new.feedback@nsc.com
Tel: 1-800-272-9959

National Semiconductor Europe Customer Support Center
Fax: +49 (0) 180-530-85-86
Email: europe.support@nsc.com
Deutsch Tel: +49 (0) 69 9508 6208
English Tel: +49 (0) 870 24 0 2171
Français Tel: +33 (0) 1 41 91 8790

National Semiconductor Asia Pacific Customer Support Center
Email: ap.support@nsc.com

National Semiconductor Japan Customer Support Center
Fax: 81-3-5639-7507
Email: jpn.feedback@nsc.com
Tel: 81-3-5639-7560