

# A1101, A1102, A1103, A1104, and A1106

## Continuous-Time Switch Family

Package LH, 3-pin Surface Mount

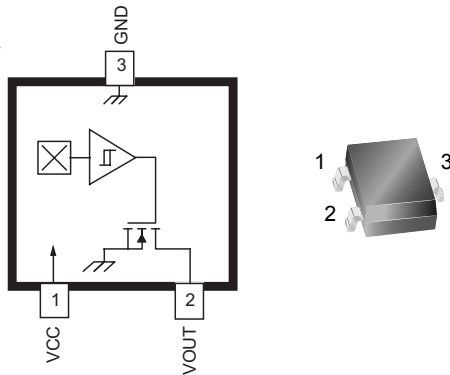

Package UA, 3-pin SIP

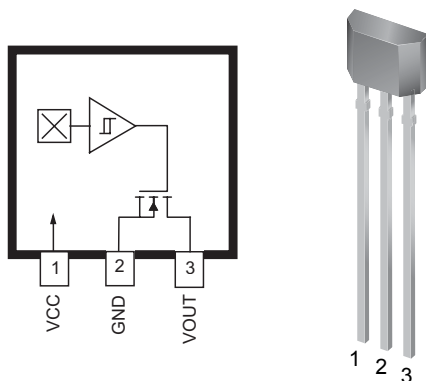

### ABSOLUTE MAXIMUM RATINGS

Supply Voltage, $V_{CC}$ .....	30 V
Reverse-Supply Voltage, $V_{RCC}$ .....	-30 V
Output Off Voltage, $V_{OUT}$ .....	30 V
Reverse-Output Voltage, $V_{ROUT}$ .....	-0.5 V
Output Current, $I_{OUTSINK}$ .....	25 mA
Magnetic Flux Density, $B$ .....	Unlimited
Operating Temperature	
Ambient, $T_A$ , Range E .....	-40°C to 85°C
Ambient, $T_A$ , Range L .....	-40°C to 150°C
Maximum Junction, $T_{J(max)}$ .....	165°C
Storage Temperature, $T_S$ .....	-65°C to 170°C

The Allegro® A1101-A1104 and A1106 Hall-effect switches are next generation replacements for the popular Allegro 312x and 314x lines of bipolar switches. The A110x family, produced with BiCMOS technology, consists of devices that feature fast power-on time and low-noise operation. Device programming is performed after packaging, to ensure increased switchpoint accuracy by eliminating offsets that can be induced by package stress. Unique Hall element geometries and low-offset amplifiers help to minimize noise and to reduce the residual offset voltage normally caused by device overmolding, temperature excursions, and thermal stress.

The A1101-A1104 and A1106 Hall-effect switches include the following on a single silicon chip: voltage regulator, Hall-voltage generator, small-signal amplifier, Schmitt trigger, and NMOS output transistor. The integrated voltage regulator permits operation from 3.8 to 24 V. The extensive on-board protection circuitry makes possible a  $\pm 30$  V absolute maximum voltage rating for superior protection in automotive and industrial motor commutation applications, without adding external components. All devices in the family are identical except for magnetic switchpoint levels.

The small geometries of the BiCMOS process allow these devices to be provided in ultrasmall packages. The package styles available provide magnetically optimized solutions for most applications. Package LH is an SOT23W, a miniature low-profile surface-mount package, while package UA is a three-lead ultramini SIP for through-hole mounting. Each package is lead (Pb) free, with 100% matte tin plated leadframes.

### Features and Benefits

- Continuous-time operation
  - Fast power-on time
  - Low noise
- Stable operation over full operating temperature range
- Reverse battery protection
- Solid-state reliability
- Factory-programmed at end-of-line for optimum performance
- Robust EMC performance
- High ESD rating
- Regulator stability without a bypass capacitor



# A1101, A1102, A1103, A1104, and A1106

## Continuous-Time Switch Family

### Product Selection Guide

Part Number	Packing*	Mounting	Ambient, T <sub>A</sub>	B <sub>RP</sub> (Min)	B <sub>OP</sub> (Max)
A1101ELHLT-T	7-in. reel, 3000 pieces/reel	3-pin SOT23W surface mount	-40°C to 85°C	10	175
A1101EUA-T	Bulk, 500 pieces/bag	3-pin SIP through hole			
A1101LLHLT-T	7-in. reel, 3000 pieces/reel	3-pin SOT23W surface mount	-40°C to 150°C	60	245
A1101LUA-T	Bulk, 500 pieces/bag	3-pin SIP through hole			
A1102ELHLT-T	7-in. reel, 3000 pieces/reel	3-pin SOT23W surface mount	-40°C to 85°C	150	355
A1102EUA-T	Bulk, 500 pieces/bag	3-pin SIP through hole			
A1102LLHLT-T	7-in. reel, 3000 pieces/reel	3-pin SOT23W surface mount	-40°C to 150°C	25	450
A1102LUA-T	Bulk, 500 pieces/bag	3-pin SIP through hole			
A1103ELHLT-T	7-in. reel, 3000 pieces/reel	3-pin SOT23W surface mount	-40°C to 85°C	160	430
A1103EUA-T	Bulk, 500 pieces/bag	3-pin SIP through hole			
A1103LLHLT-T	7-in. reel, 3000 pieces/reel	3-pin SOT23W surface mount	-40°C to 150°C	25	450
A1103LUA-T	Bulk, 500 pieces/bag	3-pin SIP through hole			
A1104ELHLT-T	7-in. reel, 3000 pieces/reel	3-pin SOT23W surface mount	-40°C to 85°C	160	430
A1104EUA-T	Bulk, 500 pieces/bag	3-pin SIP through hole			
A1104LLHLT-T	7-in. reel, 3000 pieces/reel	3-pin SOT23W surface mount	-40°C to 150°C	25	450
A1104LUA-T	Bulk, 500 pieces/bag	3-pin SIP through hole			
A1106ELHLT-T	7-in. reel, 3000 pieces/reel	3-pin SOT23W surface mount	-40°C to 85°C	160	430
A1106EUA-T	Bulk, 500 pieces/bag	3-pin SIP through hole			
A1106LLHLT-T	7-in. reel, 3000 pieces/reel	3-pin SOT23W surface mount	-40°C to 150°C	25	450
A1106LUA-T	Bulk, 500 pieces/bag	3-pin SIP through hole			

\*Contact Allegro for additional packing options.

### Functional Block Diagram

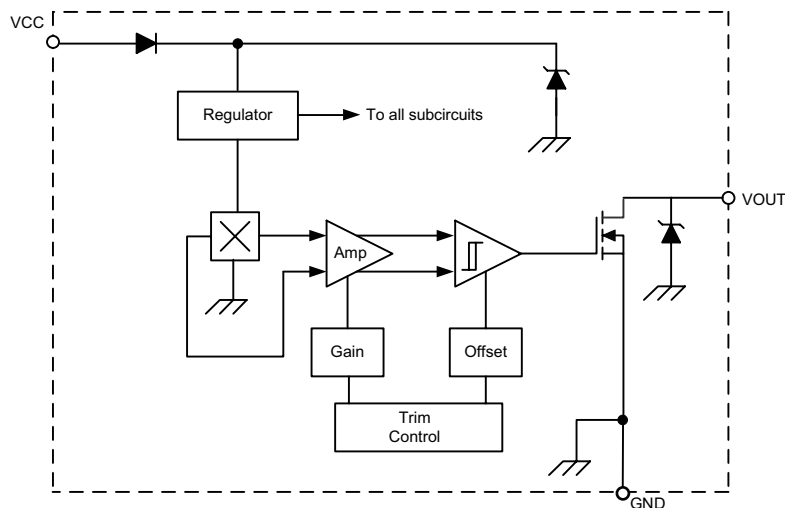

#### Terminal List

Name	Description	Number	
		Package LH	Package UA
VCC	Connects power supply to chip	1	1
VOUT	Output from circuit	2	3
GND	Ground	3	2

# A1101, A1102, A1103, A1104, and A1106

## Continuous-Time Switch Family

### ELECTRICAL OPERATING CHARACTERISTICS over full operating voltage and ambient temperature ranges, unless otherwise noted

Characteristic	Symbol	Test Conditions	Min.	Typ.	Max.	Units
Supply Voltage <sup>1</sup>	$V_{CC}$	Operating, $T_J < 165^\circ\text{C}$	3.8	–	24	V
Output Leakage Current	$I_{OUTOFF}$	$V_{OUT} = 24\text{ V}$ , $B < B_{RP}$	–	–	10	$\mu\text{A}$
Output On Voltage	$V_{OUT(SAT)}$	$I_{OUT} = 20\text{ mA}$ , $B > B_{OP}$	–	215	400	mV
Power-On Time <sup>2</sup>	$t_{PO}$	Slew rate ( $dV_{CC}/dt$ ) $< 2.5\text{ V}/\mu\text{s}$ , $B > B_{OP} + 5\text{ G}$ or $B < B_{RP} - 5\text{ G}$	–	–	4	$\mu\text{s}$
Output Rise Time <sup>3</sup>	$t_r$	$V_{CC} = 12\text{ V}$ , $R_{LOAD} = 820\ \Omega$ , $C_S = 12\text{ pF}$	–	–	400	ns
Output Fall Time <sup>3</sup>	$t_f$	$V_{CC} = 12\text{ V}$ , $R_{LOAD} = 820\ \Omega$ , $C_S = 12\text{ pF}$	–	–	400	ns
Supply Current	$I_{CCON}$	$B > B_{OP}$	–	4.1	7.5	mA
	$I_{CCOFF}$	$B < B_{RP}$	–	3.8	7.5	mA
Reverse Battery Current	$I_{RCC}$	$V_{RCC} = -30\text{ V}$	–	–	-10	mA
Supply Zener Clamp Voltage	$V_Z$	$I_{CC} = 10.5\text{ mA}$ ; $T_A = 25^\circ\text{C}$	32	–	–	V
Supply Zener Current <sup>4</sup>	$I_Z$	$V_Z = 32\text{ V}$ ; $T_A = 25^\circ\text{C}$	–	–	10.5	mA

<sup>1</sup> Maximum voltage must be adjusted for power dissipation and junction temperature, see *Power Derating* section.

<sup>2</sup> For  $V_{CC}$  slew rates greater than  $250\text{ V}/\mu\text{s}$ , and  $T_A = 150^\circ\text{C}$ , the Power-On Time can reach its maximum value.

<sup>3</sup>  $C_S$  = oscilloscope probe capacitance.

<sup>4</sup> Maximum current limit is equal to the maximum  $I_{CC(max)} + 3\text{ mA}$ .

### DEVICE QUALIFICATION PROGRAM

Contact Allegro for information.

### EMC (Electromagnetic Compatibility) REQUIREMENTS

Contact Allegro for information.

# A1101, A1102, A1103, A1104, and A1106

## Continuous-Time Switch Family

**MAGNETIC OPERATING CHARACTERISTICS<sup>1</sup>** over full operating voltage and ambient temperature ranges, unless otherwise noted

Characteristic	Symbol	Test Conditions		Min.	Typ.	Max.	Units		
Operate Point	$B_{OP}$	A1101	$T_A = 25^\circ\text{C}$	50	100	160	G		
			Operating Temperature Range	30	100	175	G		
		A1102	$T_A = 25^\circ\text{C}$	130	180	230	G		
			Operating Temperature Range	115	180	245	G		
		A1103	$T_A = 25^\circ\text{C}$	220	280	340	G		
			Operating Temperature Range	205	280	355	G		
		A1104	$T_A = 25^\circ\text{C}$	70	–	350	G		
			Operating Temperature Range	35	–	450	G		
		A1106	$T_A = 25^\circ\text{C}$	280	340	400	G		
			Operating Temperature Range	260	340	430	G		
		Release Point	$B_{RP}$	A1101	$T_A = 25^\circ\text{C}$	10	45	130	G
					Operating Temperature Range	10	45	145	G
A1102	$T_A = 25^\circ\text{C}$			75	125	175	G		
	Operating Temperature Range			60	125	190	G		
A1103	$T_A = 25^\circ\text{C}$			165	225	285	G		
	Operating Temperature Range			150	225	300	G		
A1104	$T_A = 25^\circ\text{C}$			50	–	330	G		
	Operating Temperature Range			25	–	430	G		
A1106	$T_A = 25^\circ\text{C}$			180	240	300	G		
	Operating Temperature Range			160	240	330	G		
Hysteresis	$B_{HYS}$			A1101	$T_A = 25^\circ\text{C}$	20	55	80	G
					Operating Temperature Range	20	55	80	G
		A1102	$T_A = 25^\circ\text{C}$	30	55	80	G		
			Operating Temperature Range	30	55	80	G		
		A1103	$T_A = 25^\circ\text{C}$	30	55	80	G		
			Operating Temperature Range	30	55	80	G		
		A1104	$T_A = 25^\circ\text{C}$	20	55	–	G		
			Operating Temperature Range	20	55	–	G		
		A1106	$T_A = 25^\circ\text{C}$	70	105	140	G		
			Operating Temperature Range	70	105	140	G		

<sup>1</sup> Magnetic flux density, B, is indicated as a negative value for north-polarity magnetic fields, and as a positive value for south-polarity magnetic fields. This so-called algebraic convention supports arithmetic comparison of north and south polarity values, where the relative strength of the field is indicated by the absolute value of B, and the sign indicates the polarity of the field (for example, a –100 G field and a 100 G field have equivalent strength, but opposite polarity).

# A1101, A1102, A1103, A1104, and A1106

## Continuous-Time Switch Family

**THERMAL CHARACTERISTICS may require derating at maximum conditions, see application information**

Characteristic	Symbol	Test Conditions	Value	Units
Package Thermal Resistance	$R_{\theta JA}$	Package LH, minimum-K PCB (single layer, single-sided with copper limited to solder pads)	110	$^{\circ}\text{C}/\text{W}$
		Package LH, low-K PCB (single layer, double-sided with 0.926 in <sup>2</sup> copper area)	228	$^{\circ}\text{C}/\text{W}$
		Package UA, minimum-K PCB (single layer, single-sided with copper limited to solder pads)	165	$^{\circ}\text{C}/\text{W}$

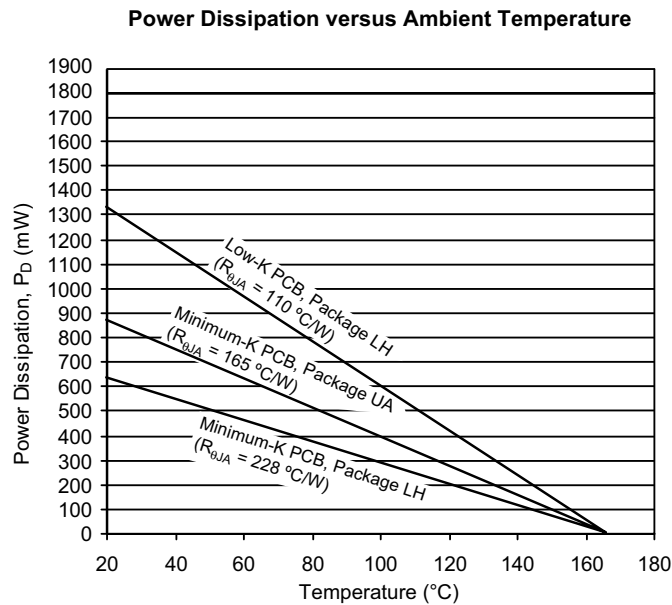
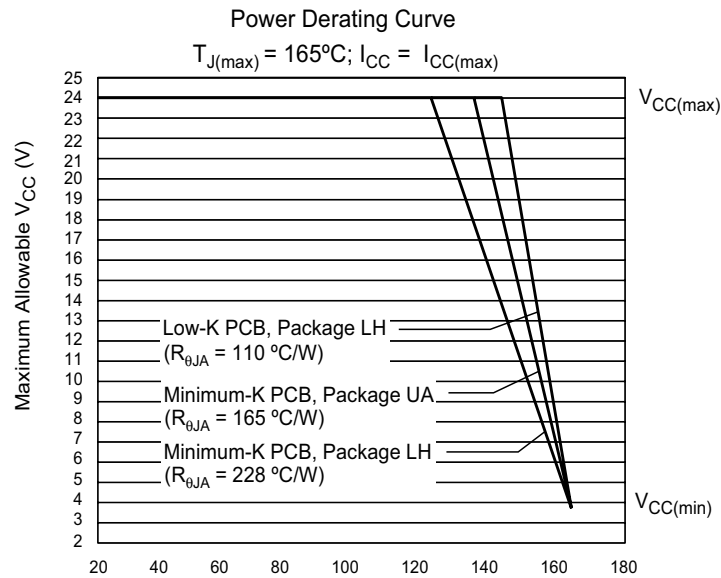

# A1101, A1102, A1103, A1104, and A1106

## Continuous-Time Switch Family

### Characteristic Data

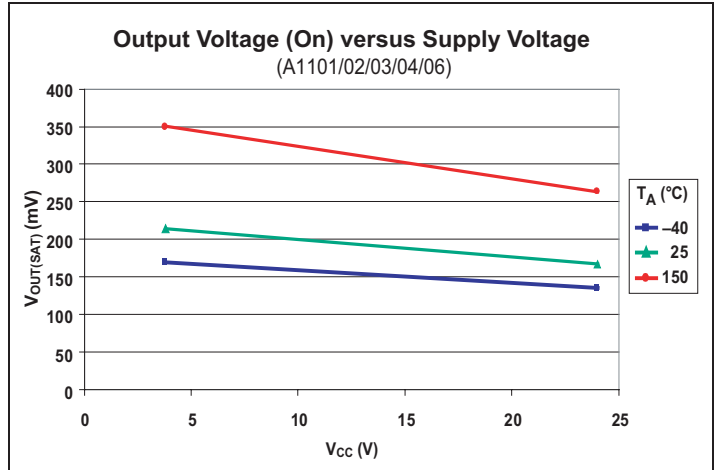
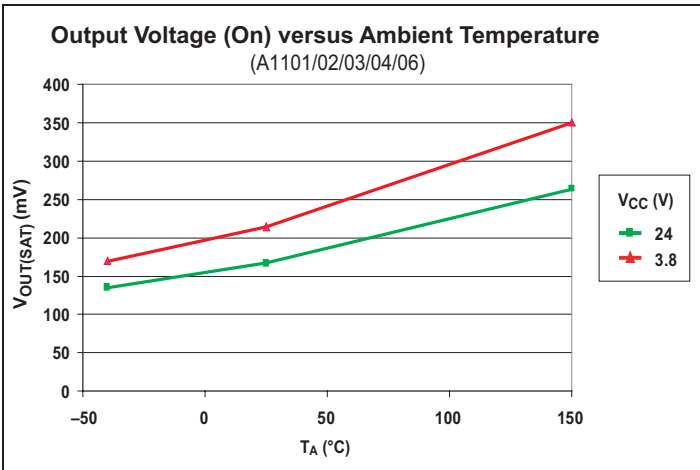
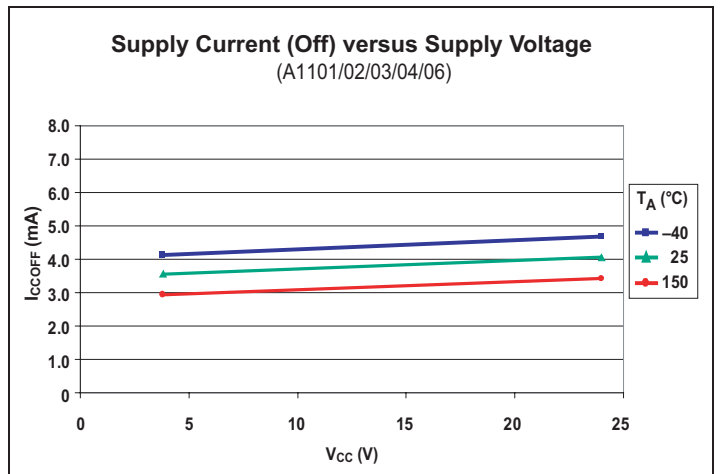
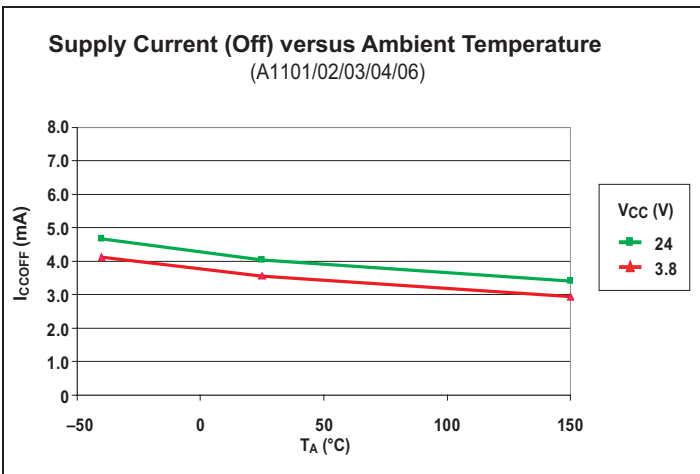
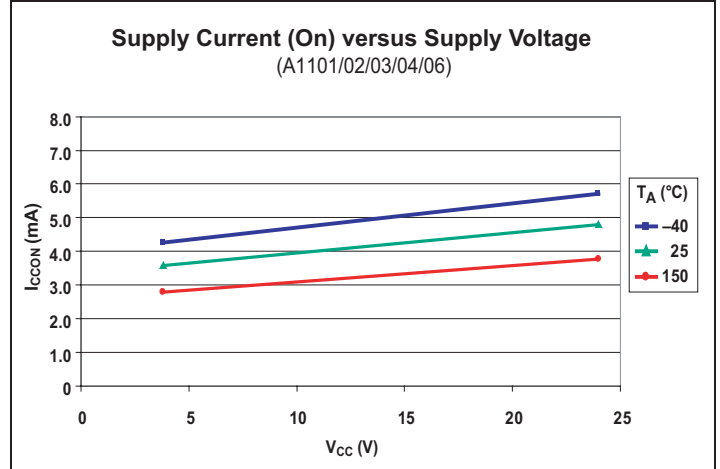
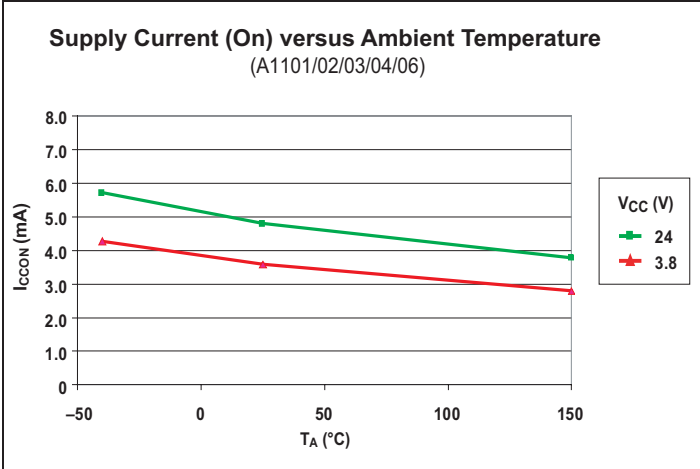

## Functional Description

### OPERATION

The output of these devices switches low (turns on) when a magnetic field (south polarity) perpendicular to the Hall sensor exceeds the operate point threshold,  $B_{OP}$ . After turn-on, the output is capable of sinking 25 mA and the output voltage is  $V_{OUT(SAT)}$ . When the magnetic field is reduced below the release point,  $B_{RP}$ , the device output goes high (turns off). The difference in the magnetic operate and release points is the hysteresis,  $B_{HYS}$ , of the device. This built-in hysteresis allows clean switching of the output, even in the presence of external mechanical vibration and electrical noise.

Powering-on the device in the hysteresis region, less than  $B_{OP}$  and higher than  $B_{RP}$ , allows an indeterminate output state. The correct state is attained after the first excursion beyond  $B_{OP}$  or  $B_{RP}$ .

### CONTINUOUS-TIME BENEFITS

Continuous-time devices, such as the A110x family, offer the fastest available power-on settling time and frequency response. Due to offsets generated during the IC packaging process,

continuous-time devices typically require programming after packaging to tighten magnetic parameter distributions. In contrast, chopper-stabilized switches employ an offset cancellation technique on the chip that eliminates these offsets without the need for after-packaging programming. The tradeoff is a longer settling time and reduced frequency response as a result of the chopper-stabilization offset cancellation algorithm.

The choice between continuous-time and chopper-stabilized designs is solely determined by the application. Battery management is an example where continuous-time is often required. In these applications,  $V_{CC}$  is chopped with a very small duty cycle in order to conserve power (refer to figure 2). The duty cycle is controlled by the power-on time,  $t_{PO}$ , of the device. Because continuous-time devices have the shorter power-on time, they are the clear choice for such applications.

For more information on the chopper stabilization technique, refer to Technical Paper STP 97-10, *Monolithic Magnetic Hall Sensor Using Dynamic Quadrature Offset Cancellation* and Technical Paper STP 99-1, *Chopper-Stabilized Amplifiers with a Track-and-Hold Signal Demodulator*.

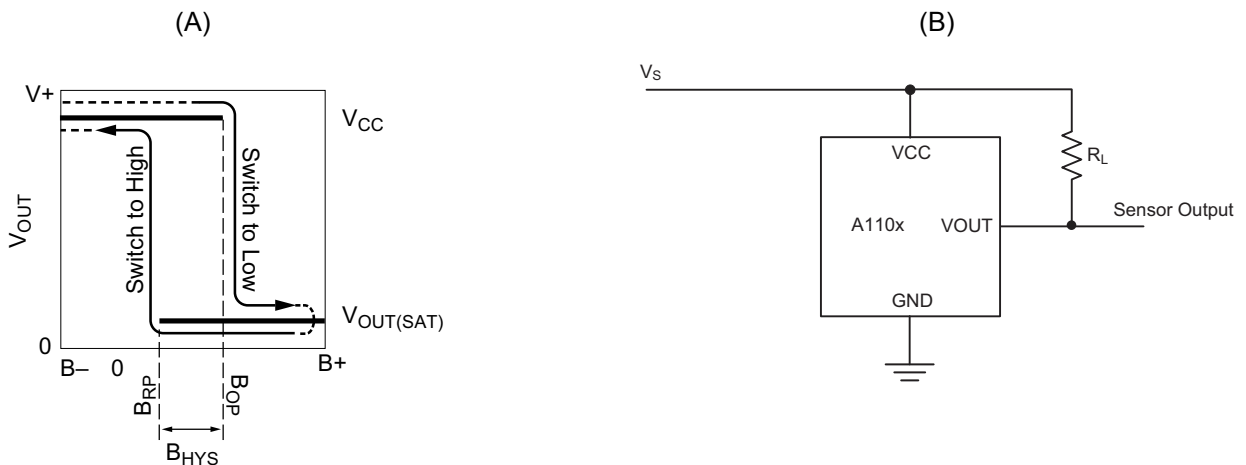

Figure 1. Switching Behavior of Unipolar Switches. On the horizontal axis, the  $B+$  direction indicates increasing south polarity magnetic field strength, and the  $B-$  direction indicates decreasing south polarity field strength (including the case of increasing north polarity). This behavior can be exhibited when using a circuit such as that shown in Panel B.

# A1101, A1102, A1103, A1104, and A1106

## Continuous-Time Switch Family

### ADDITIONAL APPLICATIONS INFORMATION

Extensive applications information for Hall-effect sensors is available in:

- *Hall-Effect IC Applications Guide*, Application Note 27701
- *Hall-Effect Devices: Gluing, Potting, Encapsulating, Lead Welding and Lead Forming*, Application Note 27703.1
- *Soldering Methods for Allegro's Products – SMT and Through-Hole*, Application Note 26009

All are provided in *Allegro Electronic Data Book*, AMS-702, and the Allegro Web site, [www.allegromicro.com](http://www.allegromicro.com).

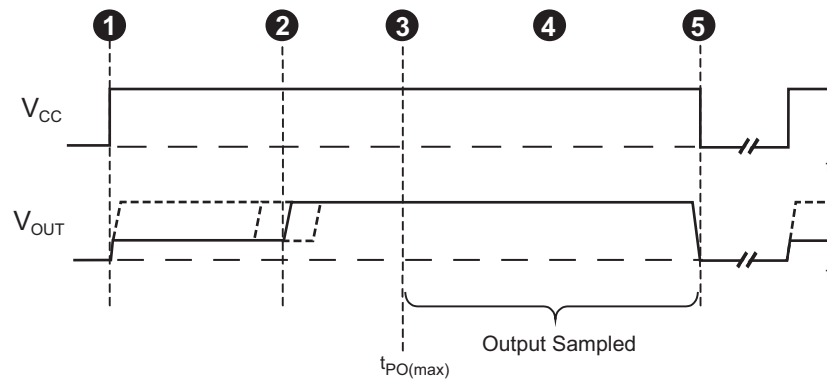

Figure 2. Continuous-Time Application,  $B < B_{RP}$ . This figure illustrates the use of a quick cycle for chopping  $V_{CC}$  in order to conserve battery power. Position 1, power is applied to the device. Position 2, the output assumes the correct state at a time prior to the maximum Power-On Time,  $t_{PO(max)}$ . The case shown is where the correct output state is HIGH. Position 3,  $t_{PO(max)}$  has elapsed. The device output is valid. Position 4, after the output is valid, a control unit reads the output. Position 5, power is removed from the device.



## Power Derating

### Power Derating

The device must be operated below the maximum junction temperature of the device,  $T_{J(\max)}$ . Under certain combinations of peak conditions, reliable operation may require derating supplied power or improving the heat dissipation properties of the application. This section presents a procedure for correlating factors affecting operating  $T_J$ . (Thermal data is also available on the Allegro MicroSystems Web site.)

The Package Thermal Resistance,  $R_{\theta JA}$ , is a figure of merit summarizing the ability of the application and the device to dissipate heat from the junction (die), through all paths to the ambient air. Its primary component is the Effective Thermal Conductivity,  $K$ , of the printed circuit board, including adjacent devices and traces. Radiation from the die through the device case,  $R_{\theta JC}$ , is relatively small component of  $R_{\theta JA}$ . Ambient air temperature,  $T_A$ , and air motion are significant external factors, damped by overmolding.

The effect of varying power levels (Power Dissipation,  $P_D$ ), can be estimated. The following formulas represent the fundamental relationships used to estimate  $T_J$ , at  $P_D$ .

$$P_D = V_{IN} \times I_{IN} \quad (1)$$

$$\Delta T = P_D \times R_{\theta JA} \quad (2)$$

$$T_J = T_A + \Delta T \quad (3)$$

For example, given common conditions such as:  $T_A = 25^\circ\text{C}$ ,  $V_{CC} = 12\text{ V}$ ,  $I_{CC} = 4\text{ mA}$ , and  $R_{\theta JA} = 140\text{ }^\circ\text{C/W}$ , then:

$$P_D = V_{CC} \times I_{CC} = 12\text{ V} \times 4\text{ mA} = 48\text{ mW}$$

$$\Delta T = P_D \times R_{\theta JA} = 48\text{ mW} \times 140\text{ }^\circ\text{C/W} = 7^\circ\text{C}$$

$$T_J = T_A + \Delta T = 25^\circ\text{C} + 7^\circ\text{C} = 32^\circ\text{C}$$

A worst-case estimate,  $P_{D(\max)}$ , represents the maximum allowable power level ( $V_{CC(\max)}$ ,  $I_{CC(\max)}$ ), without exceeding  $T_{J(\max)}$ , at a selected  $R_{\theta JA}$  and  $T_A$ .

*Example:* Reliability for  $V_{CC}$  at  $T_A = 150^\circ\text{C}$ , package UA, using minimum-K PCB.

Observe the worst-case ratings for the device, specifically:  $R_{\theta JA} = 165^\circ\text{C/W}$ ,  $T_{J(\max)} = 165^\circ\text{C}$ ,  $V_{CC(\max)} = 24\text{ V}$ , and  $I_{CC(\max)} = 7.5\text{ mA}$ .

Calculate the maximum allowable power level,  $P_{D(\max)}$ . First, invert equation 3:

$$\Delta T_{\max} = T_{J(\max)} - T_A = 165^\circ\text{C} - 150^\circ\text{C} = 15^\circ\text{C}$$

This provides the allowable increase to  $T_J$  resulting from internal power dissipation. Then, invert equation 2:

$$P_{D(\max)} = \Delta T_{\max} \div R_{\theta JA} = 15^\circ\text{C} \div 165\text{ }^\circ\text{C/W} = 91\text{ mW}$$

Finally, invert equation 1 with respect to voltage:

$$V_{CC(\text{est})} = P_{D(\max)} \div I_{CC(\max)} = 91\text{ mW} \div 7.5\text{ mA} = 12.1\text{ V}$$

The result indicates that, at  $T_A$ , the application and device can dissipate adequate amounts of heat at voltages  $\leq V_{CC(\text{est})}$ .

Compare  $V_{CC(\text{est})}$  to  $V_{CC(\max)}$ . If  $V_{CC(\text{est})} \leq V_{CC(\max)}$ , then reliable operation between  $V_{CC(\text{est})}$  and  $V_{CC(\max)}$  requires enhanced  $R_{\theta JA}$ . If  $V_{CC(\text{est})} \geq V_{CC(\max)}$ , then operation between  $V_{CC(\text{est})}$  and  $V_{CC(\max)}$  is reliable under these conditions.

# A1101, A1102, A1103, A1104, and A1106

## Continuous-Time Switch Family

### Package LH, 3-Pin (SOT-23W)

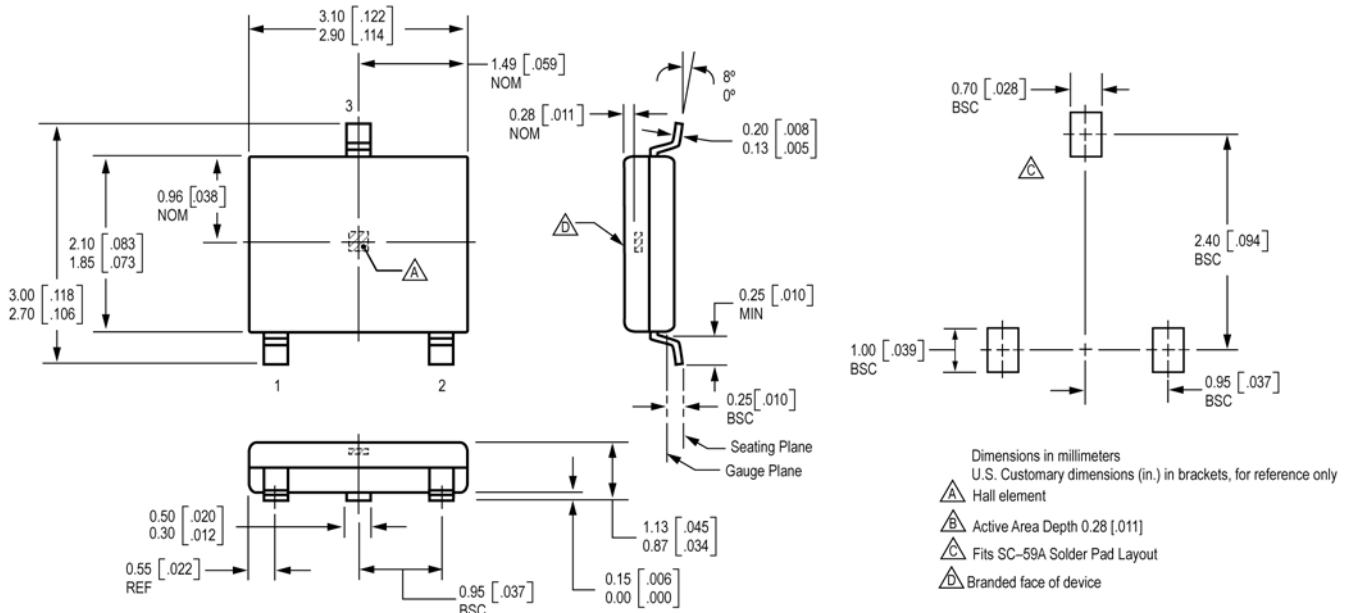

### Package UA, 3-Pin

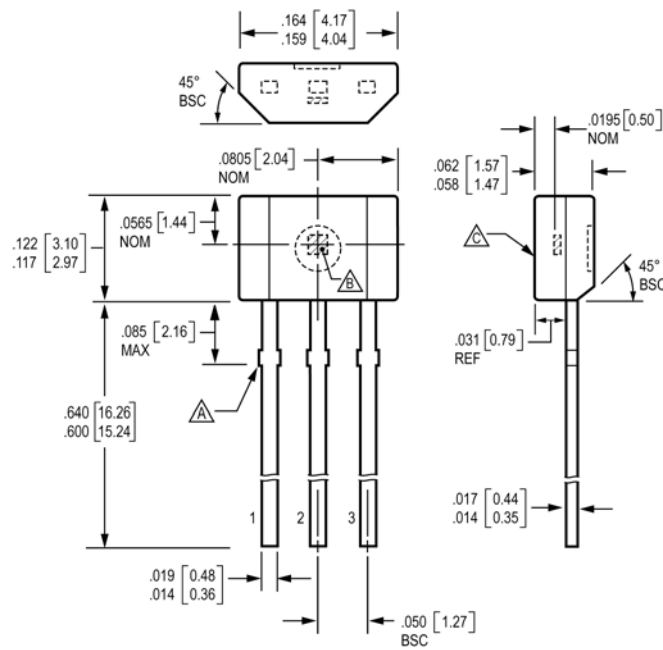

# A1101, A1102, A1103, A1104, and A1106

## Continuous-Time Switch Family

*The products described herein are manufactured under one or more of the following U.S. patents: 5,045,920; 5,264,783; 5,442,283; 5,389,889; 5,581,179; 5,517,112; 5,619,137; 5,621,319; 5,650,719; 5,686,894; 5,694,038; 5,729,130; 5,917,320; and other patents pending.*

*Allegro MicroSystems, Inc. reserves the right to make, from time to time, such departures from the detail specifications as may be required to permit improvements in the performance, reliability, or manufacturability of its products. Before placing an order, the user is cautioned to verify that the information being relied upon is current.*

*Allegro products are not authorized for use as critical components in life-support devices or systems without express written approval.*

*The information included herein is believed to be accurate and reliable. However, Allegro MicroSystems, Inc. assumes no responsibility for its use; nor for any infringement of patents or other rights of third parties which may result from its use.*

*Copyright © 2005, Allegro MicroSystems, Inc.*