

Sensitive SCRs

(0.8 A to 10 A) RoHS

General Description

The Teccor line of sensitive SCR semiconductors are half-wave unidirectional, gate-controlled rectifiers (SCR-thyristor) which complement Teccor's line of power SCRs. This group of packages offers ratings of 0.8 A to 10 A, and 200 V to 600 V with gate sensitivities of 12 μ A to 500 μ A. For gate currents in the 10 mA to 50 mA ranges, see "SCRs" section of this catalog.

The TO-220 and TO-92 are electrically isolated where the case or tab is internally isolated to allow the use of low-cost assembly and convenient packaging techniques.

Teccor's line of SCRs features glass-passivated junctions to ensure long-term device reliability and parameter stability. Teccor's glass offers a rugged, reliable barrier against junction contamination.

Tape-and-reel packaging is available for the TO-92 package. Consult the factory for more information.





Variations of devices covered in this data sheet are available for custom design applications. Consult the factory for more information.

Features

- RoHS Compliant
- Electrically-isolated TO-220 package
- High voltage capability — up to 600 V
- High surge capability — up to 100 A
- Glass-passivated chip

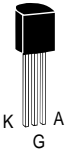
Compak Features

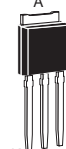
- Surface mount package — 0.8 A series
- New small-profile three-leaded Compak package
- Four gate sensitivities available
- Packaged in embossed carrier tape with 2,500 devices per reel
- Can replace SOT-223

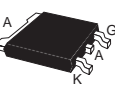
| TYPE | Part Number | | | | | I_T | | V_{DRM} & V_{RRM} | I_{GT} | I_{DRM} & I_{RRM} | | | V_{TM} | |
|---|---|---|---|---|---|--------------|-------------|-----------------------|-----------------------------------|------------------------------------|------------------------------------|-------|----------|-----|
| | Non-isolated | | | | | I_T | | | | μAmps | μAmps | | | |
| |  |  |  |  |  | (1) | (1) | (2) (12) | (20) (21) | | (3) (10) | | | |
| | TO-92 | TO-202 | TO-251 V-Pak | Compak | TO-252 D-Pak | Amps | | Volts | T_C or $T_L = 25^\circ\text{C}$ | T_C or $T_L = 100^\circ\text{C}$ | T_C or $T_L = 110^\circ\text{C}$ | Volts | | |
| See "Package Dimensions" section for variations. (11) | | | | | | $I_{T(RMS)}$ | $I_{T(AV)}$ | MIN | MAX | MAX | | MAX | | |
| 0.8 A | | | | S2S1 | | 0.8 | 0.51 | 200 | 12 | 2 | | 100 | 1.7 | |
| | | | | S4S1 | | 0.8 | 0.51 | 400 | 12 | 2 | | 100 | 1.7 | |
| | | | | S6S1 | | 0.8 | 0.51 | 600 | 12 | 2 | | 100 | 1.7 | |
| | | | | S2S2 | | 0.8 | 0.51 | 200 | 50 | 2 | | 100 | 1.7 | |
| | | | | S4S2 | | 0.8 | 0.51 | 400 | 50 | 2 | | 100 | 1.7 | |
| | | | | S6S2 | | 0.8 | 0.51 | 600 | 50 | 2 | | 100 | 1.7 | |
| | | | | S2S | | 0.8 | 0.51 | 200 | 200 | 2 | | 100 | 1.7 | |
| | | | | S4S | | 0.8 | 0.51 | 400 | 200 | 2 | | 100 | 1.7 | |
| | | | | S6S | | 0.8 | 0.51 | 600 | 200 | 2 | | 100 | 1.7 | |
| | | | | S2S3 | | 0.8 | 0.51 | 200 | 500 | 2 | | 100 | 1.7 | |
| | | | | S4S3 | | 0.8 | 0.51 | 400 | 500 | 2 | | 100 | 1.7 | |
| | | | | S6S3 | | 0.8 | 0.51 | 600 | 500 | 2 | | 100 | 1.7 | |
| | | EC103B | | | | 0.8 | 0.51 | 200 | 200 | 1 | 50 | | 100 | 1.7 |
| | | EC103D | | | | 0.8 | 0.51 | 400 | 200 | 1 | 50 | | 100 | 1.7 |
| | | EC103M | | | | 0.8 | 0.51 | 600 | 200 | 2 | 100 | | 100 | 1.7 |
| | | EC103B1 | | | | 0.8 | 0.51 | 200 | 12 | 1 | 50 | | 100 | 1.7 |
| | | EC103D1 | | | | 0.8 | 0.51 | 400 | 12 | 1 | 50 | | 100 | 1.7 |
| | | EC103M1 | | | | 0.8 | 0.51 | 600 | 12 | 2 | 100 | | 100 | 1.7 |
| | | EC103B2 | | | | 0.8 | 0.51 | 200 | 50 | 1 | 50 | | 100 | 1.7 |
| | | EC103D2 | | | | 0.8 | 0.51 | 400 | 50 | 1 | 50 | | 100 | 1.7 |
| | EC103M2 | | | | 0.8 | 0.51 | 600 | 50 | 2 | 100 | | 100 | 1.7 | |
| | EC103B3 | | | | 0.8 | 0.51 | 200 | 500 | 1 | 50 | | 100 | 1.7 | |
| | EC103D3 | | | | 0.8 | 0.51 | 400 | 500 | 1 | 50 | | 100 | 1.7 | |
| | EC103M3 | | | | 0.8 | 0.51 | 600 | 500 | 2 | 100 | | 100 | 1.7 | |
| | 2N5064 | | | | 0.8 | 0.51 | 200 | 200 | 1 | | 50 | 100 | 1.7 | |
| | 2N6565 | | | | 0.8 | 0.51 | 400 | 200 | 1 | | 100 | 100 | 1.7 | |
| 1.5 A | | | | TCR22-4 | | 1.5 | 0.95 | 200 | 200 | 1 | | 100 | 1.5 | |
| | | | | TCR22-6 | | 1.5 | 0.95 | 400 | 200 | 1 | | 100 | 1.5 | |
| | | | | TCR22-8 | | 1.5 | 0.95 | 600 | 200 | 2 | | 100 | 1.5 | |
| 4 A | | T106B1 | | | | 4 | 2.5 | 200 | 200 | 2 | | 100 | 2.2 | |
| | | T106D1 | | | | 4 | 2.5 | 400 | 200 | 2 | | 100 | 2.2 | |
| | | T106M1 | | | | 4 | 2.5 | 600 | 200 | 2 | | 100 | 2.2 | |
| | | T107B1 | | | | 4 | 2.5 | 200 | 500 | 2 | | 100 | 2.5 | |
| | | T107D1 | | | | 4 | 2.5 | 400 | 500 | 2 | | 100 | 2.5 | |
| | | T107M1 | | | | 4 | 2.5 | 600 | 500 | 2 | | 100 | 2.5 | |
| | | | S2004VS1 | | S2004DS1 | 4 | 2.5 | 200 | 50 | 2 | | 100 | 1.6 | |
| | | | S4004VS1 | | S4004DS1 | 4 | 2.5 | 400 | 50 | 2 | | 100 | 1.6 | |
| | | | S6004VS1 | | S6004DS1 | 4 | 2.5 | 600 | 50 | 2 | | 100 | 1.6 | |
| | | | S2004VS2 | | S2004DS2 | 4 | 2.5 | 200 | 200 | 2 | | 100 | 1.6 | |
| | | S4004VS2 | | S4004DS2 | 4 | 2.5 | 400 | 200 | 2 | | 100 | 1.6 | | |
| | | S6004VS2 | | S6004DS2 | 4 | 2.5 | 600 | 200 | 2 | | 100 | 1.6 | | |

See "General Notes" on page E5 - 4 and "Electrical Specifications Notes" on page E5 - 5

| V _{GT} | | | I _H | I _{GM} | V _{GRM} | P _{GM} | P _{G(AV)} | I _{TSM} | dv/dt | | di/dt | t _{gt} | t _q | I ² t |
|--|---|--|-----------------------|-----------------|------------------|-----------------|--------------------|------------------|------------|----------|-----------|-----------------|----------------|------------------------|
| (4) (12) (22) | | | (5) (15) (16) (19) | (17) | | (17) | | (6) (7) (13) | | | | (8) | (9) | |
| Volts | | | | | | | | Amps | | | | | | |
| T _C or T _L = -40 °C | T _C or T _L = 25 °C | T _C or T _L = 110 °C | mAmps | Amps | Volts | Watts | Watts | 60/50 Hz | Volts/μSec | | Amps/μSec | μSec | μSec | Amps ² /Sec |
| MAX | | | MAX | | MIN | | | | MIN | TYP (23) | | TYP | MAX | |
| 1.2 | 0.8 | 0.2 | 5 | 1 | 5 | 1 | 0.1 | 20/16 | 20 | | 50 | 2 | 60 | 1.6 |
| 1.2 | 0.8 | 0.2 | 5 | 1 | 5 | 1 | 0.1 | 20/16 | 20 | | 50 | 2 | 60 | 1.6 |
| 1.2 | 0.8 | 0.2 | 5 | 1 | 5 | 1 | 0.1 | 20/16 | 10 | | 50 | 2 | 60 | 1.6 |
| 1.2 | 0.8 | 0.25 | 5 | 1 | 5 | 1 | 0.1 | 20/16 | 25 | | 50 | 3 | 60 | 1.6 |
| 1.2 | 0.8 | 0.25 | 5 | 1 | 5 | 1 | 0.1 | 20/16 | 25 | | 50 | 3 | 60 | 1.6 |
| 1.2 | 0.8 | 0.25 | 5 | 1 | 5 | 1 | 0.1 | 20/16 | 10 | | 50 | 3 | 60 | 1.6 |
| 1.2 | 0.8 | 0.25 | 5 | 1 | 5 | 1 | 0.1 | 20/16 | 30 | | 50 | 4 | 50 | 1.6 |
| 1.2 | 0.8 | 0.25 | 5 | 1 | 5 | 1 | 0.1 | 20/16 | 30 | | 50 | 4 | 50 | 1.6 |
| 1.2 | 0.8 | 0.25 | 5 | 1 | 5 | 1 | 0.1 | 20/16 | 15 | | 50 | 4 | 50 | 1.6 |
| 1.2 | 0.8 | 0.25 | 8 | 1 | 5 | 1 | 0.1 | 20/16 | 40 | | 50 | 5 | 45 | 1.6 |
| 1.2 | 0.8 | 0.25 | 8 | 1 | 5 | 1 | 0.1 | 20/16 | 40 | | 50 | 5 | 45 | 1.6 |
| 1.2 | 0.8 | 0.25 | 8 | 1 | 5 | 1 | 0.1 | 20/16 | 20 | | 50 | 5 | 45 | 1.6 |
| 1.2 | 0.8 | 0.25 | 5 | 1 | 5 | 1 | 0.1 | 20/16 | 30 | | 50 | 3.5 | 50 | 1.6 |
| 1.2 | 0.8 | 0.25 | 5 | 1 | 5 | 1 | 0.1 | 20/16 | 30 | | 50 | 3.5 | 50 | 1.6 |
| 1.2 | 0.8 | 0.25 | 5 | 1 | 5 | 1 | 0.1 | 20/16 | 15 | | 50 | 3.5 | 50 | 1.6 |
| 1.2 | 0.8 | 0.2 | 5 | 1 | 5 | 1 | 0.1 | 20/16 | 20 | | 50 | 2 | 60 | 1.6 |
| 1.2 | 0.8 | 0.2 | 5 | 1 | 5 | 1 | 0.1 | 20/16 | 20 | | 50 | 2 | 60 | 1.6 |
| 1.2 | 0.8 | 0.2 | 5 | 1 | 5 | 1 | 0.1 | 20/16 | 10 | | 50 | 2 | 60 | 1.6 |
| 1.2 | 0.8 | 0.25 | 5 | 1 | 5 | 1 | 0.1 | 20/16 | 25 | | 50 | 3 | 60 | 1.6 |
| 1.2 | 0.8 | 0.25 | 5 | 1 | 5 | 1 | 0.1 | 20/16 | 25 | | 50 | 3 | 60 | 1.6 |
| 1.2 | 0.8 | 0.25 | 5 | 1 | 5 | 1 | 0.1 | 20/16 | 10 | | 50 | 3 | 60 | 1.6 |
| 1.2 | 0.8 | 0.25 | 8 | 1 | 5 | 1 | 0.1 | 20/16 | 40 | | 50 | 5 | 45 | 1.6 |
| 1.2 | 0.8 | 0.25 | 8 | 1 | 5 | 1 | 0.1 | 20/16 | 40 | | 50 | 5 | 45 | 1.6 |
| 1.2 | 0.8 | 0.25 | 8 | 1 | 5 | 1 | 0.1 | 20/16 | 20 | | 50 | 5 | 45 | 1.6 |
| 1.2 | 0.8 | 0.25 | 5 | 1 | 5 | 1 | 0.1 | 20/16 | 25 | | 50 | 2.2 | 60 | 1.6 |
| 1.2 | 0.8 | 0.25 | 5 | 1 | 6 | 1 | 0.1 | 20/16 | 25 | | 50 | 2.2 | 60 | 1.6 |
| 1 | 0.8 | 0.25 | 5 | 1 | 6 | 1 | 0.1 | 20/16 | 60 | | 50 | 3.5 | 50 | 1.6 |
| 1 | 0.8 | 0.25 | 5 | 1 | 6 | 1 | 0.1 | 20/16 | 40 | | 50 | 3.5 | 50 | 1.6 |
| 1 | 0.8 | 0.25 | 5 | 1 | 6 | 1 | 0.1 | 20/16 | 30 | | 50 | 3.5 | 50 | 1.6 |
| 1 | 0.8 | 0.2 | 5 | 1 | 6 | 1 | 0.1 | 20/16 | | 8 | 50 | 4 | 50 | 1.6 |
| 1 | 0.8 | 0.2 | 5 | 1 | 6 | 1 | 0.1 | 20/16 | | 8 | 50 | 4 | 50 | 1.6 |
| 1 | 0.8 | 0.2 | 5 | 1 | 6 | 1 | 0.1 | 20/16 | | 8 | 50 | 4 | 50 | 1.6 |
| 1 | 0.8 | 0.2 | 6 | 1 | 6 | 1 | 0.1 | 20/16 | | 8 | 50 | 5 | 45 | 1.6 |
| 1 | 0.8 | 0.2 | 6 | 1 | 6 | 1 | 0.1 | 20/16 | | 8 | 50 | 5 | 45 | 1.6 |
| 1 | 0.8 | 0.2 | 6 | 1 | 6 | 1 | 0.1 | 20/16 | | 8 | 50 | 5 | 45 | 1.6 |
| 1 | 0.8 | 0.2 | 4 | 1 | 6 | 1 | 0.1 | 30/25 | | 8 | 50 | 3 | 50 | 3.7 |
| 1 | 0.8 | 0.2 | 4 | 1 | 6 | 1 | 0.1 | 30/25 | | 8 | 50 | 3 | 50 | 3.7 |
| 1 | 0.8 | 0.2 | 4 | 1 | 6 | 1 | 0.1 | 30/25 | | 8 | 50 | 3 | 50 | 3.7 |
| 1 | 0.8 | 0.2 | 6 | 1 | 6 | 1 | 0.1 | 30/25 | | 8 | 50 | 4 | 50 | 3.7 |
| 1 | 0.8 | 0.2 | 6 | 1 | 6 | 1 | 0.1 | 30/25 | | 8 | 50 | 4 | 50 | 3.7 |
| 1 | 0.8 | 0.2 | 6 | 1 | 6 | 1 | 0.1 | 30/25 | | 8 | 50 | 4 | 50 | 3.7 |

See "General Notes" on page E5 - 4 and "Electrical Specifications Notes" on page E5 - 5

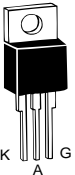
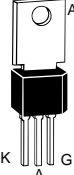
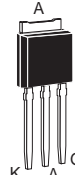
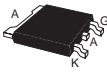
| TYPE | Part Number | | | | I _T | | V _{DRM} & V _{R_{RRM}} | I _{GT} | I _{DRM} & I _{R_{RRM}} | | V _{TM} |
|---|---|---|---|---|--------------------|-------|---|------------------------|---|-------|-----------------|
| | Isolated | Non-isolated | | | | | | | | | |
| |  |  |  |  | (1) | | | (2) (12) | (20) (21) | | (3) (10) |
| | TO-220 | TO-202 | TO-251 V-Pak | TO-252 D-Pak | Amps | | | | μAmps | | |
| See "Package Dimensions" section for variations. (11) | | | | I _{T(RMS)} | I _{T(AV)} | Volts | μAmps | T _C = 25 °C | T _C = 110 °C | Volts | |
| | | | | MAX | MAX | MIN | MAX | MAX | MAX | MAX | |
| 6 A | S2006LS2 | S2006FS21 | S2006VS2 | S2006DS2 | 6 | 3.8 | 200 | 200 | 5 | 250 | 1.6 |
| | S4006LS2 | S4006FS21 | S4006VS2 | S4006DS2 | 6 | 3.8 | 400 | 200 | 5 | 250 | 1.6 |
| | S6006LS2 | S6006FS21 | S6006VS2 | S6006DS2 | 6 | 3.8 | 600 | 200 | 5 | 250 | 1.6 |
| | S2006LS3 | S2006FS31 | S2006VS3 | S2006DS3 | 6 | 3.8 | 200 | 500 | 5 | 250 | 1.6 |
| | S4006LS3 | S4006FS31 | S4006VS3 | S4006DS3 | 6 | 3.8 | 400 | 500 | 5 | 250 | 1.6 |
| | S6006LS3 | S6006FS31 | S6006VS3 | S6006DS3 | 6 | 3.8 | 600 | 500 | 5 | 250 | 1.6 |
| 8 A | S2008LS2 | S2008FS21 | S2008VS2 | S2008DS2 | 8 | 5.1 | 200 | 200 | 5 | 250 | 1.6 |
| | S4008LS2 | S4008FS21 | S4008VS2 | S4008DS2 | 8 | 5.1 | 400 | 200 | 5 | 250 | 1.6 |
| | S6008LS2 | S6008FS21 | S6008VS2 | S6008DS2 | 8 | 5.1 | 600 | 200 | 5 | 250 | 1.6 |
| | S2008LS3 | S2008FS31 | S2008VS3 | S2008DS3 | 8 | 5.1 | 200 | 500 | 5 | 250 | 1.6 |
| | S4008LS3 | S4008FS31 | S4008VS3 | S4008DS3 | 8 | 5.1 | 400 | 500 | 5 | 250 | 1.6 |
| | S6008LS3 | S6008FS31 | S6008VS3 | S6008DS3 | 8 | 5.1 | 600 | 500 | 5 | 250 | 1.6 |
| 10 A | S2010LS2 | S2010FS21 | S2010VS2 | S2010DS2 | 10 | 6.4 | 200 | 200 | 5 | 250 | 1.6 |
| | S4010LS2 | S4010FS21 | S4010VS2 | S4010DS2 | 10 | 6.4 | 400 | 200 | 5 | 250 | 1.6 |
| | S6010LS2 | S6010FS21 | S6010VS2 | S6010DS2 | 10 | 6.4 | 600 | 200 | 5 | 250 | 1.6 |
| | S2010LS3 | S2010FS31 | S2010VS3 | S2010DS3 | 10 | 6.4 | 200 | 500 | 5 | 250 | 1.6 |
| | S4010LS3 | S4010FS31 | S4010VS3 | S4010DS3 | 10 | 6.4 | 400 | 500 | 5 | 250 | 1.6 |
| | S6010LS3 | S6010FS31 | S6010VS3 | S6010DS3 | 10 | 6.4 | 600 | 500 | 5 | 250 | 1.6 |

Specific Test Conditions

- di/dt** — Maximum rate-of-change of on-state current; I_{GT} = 50 mA pulse width ≥15 μsec with ≤0.1 μs rise time
- dv/dt** — Critical rate-of-rise of forward off-state voltage
- I²t** — RMS surge (non-repetitive) on-state current for period of 8.3 ms for fusing
- I_{DRM} and I_{R_{RRM}}** — Peak off-state current at V_{DRM} and V_{R_{RRM}}
- I_{GT}** — DC gate trigger current V_D = 6 V dc; R_L = 100 Ω
- I_{GM}** — Peak gate current
- I_H** — DC holding current; initial on-state current = 20 mA
- I_T** — Maximum on-state current
- I_{TSM}** — Peak one-cycle forward surge current
- P_{G(AV)}** — Average gate power dissipation
- P_{GM}** — Peak gate power dissipation
- t_{gt}** — Gate controlled turn-on time gate pulse = 10 mA; minimum width = 15 μS with rise time ≤0.1 μs
- t_q** — Circuit commutated turn-off time
- V_{DRM} and V_{R_{RRM}}** — Repetitive peak off-state forward and reverse voltage
- V_{GRM}** — Peak reverse gate voltage
- V_{GT}** — DC gate trigger voltage; V_D = 6 V dc; R_L = 100 Ω
- V_{TM}** — Peak on-state voltage





General Notes

- Teccor 2N5064 and 2N6565 Series devices conform to all JEDEC registered data. See specifications table on pages E5 - 2 and E5 - 3.
- The case lead temperature (T_C or T_L) is measured as shown on dimensional outline drawings in the "Package Dimensions" section of this catalog.
- All measurements (except I_{GT}) are made with an external resistor R_{GK} = 1 kΩ unless otherwise noted.
- All measurements are made at 60 Hz with a resistive load at an ambient temperature of +25 °C unless otherwise specified.
- Operating temperature (T_J) is -65 °C to +110 °C for EC Series devices, -65 °C to +125 °C for 2N Series devices, -40 °C to +125 °C for "TCR" Series, and -40 °C to +110 °C for all others.
- Storage temperature range (T_S) is -65 °C to +150 °C for TO-92 devices, -40 °C to +150 °C for TO-202 and Compak devices, and -40 °C to +125 °C for all others.
- Lead solder temperature is a maximum of +230 °C for 10 seconds maximum ≥1/16" (1.59 mm) from case.

| V _{GT} | | | I _H | I _{GM} | V _{GRM} | P _{GM} | P _{G(AV)} | I _{TSM} | dv/dt | di/dt | t _{gt} | t _q | I ² t |
|----------------------------|---------------------------|----------------------------|----------------|-----------------|------------------|-----------------|--------------------|------------------|-------------------------|-----------|-----------------|----------------|-----------------------|
| (4) (12) (22) | | | (5) (19) | (17) | | (17) | | (6) (13) | | | (8) | (9) | |
| Volts | | | | | | | | | Volts/μSec | | | | |
| T _C = -40 °C | T _C = 25 °C | T _C = 110 °C | mAmps | Amps | Volts | Watts | Watts | Amps | T _C = 110 °C | Amps/μSec | μSec | μSec | Amps ² Sec |
| MAX | | | MAX | | MIN | | | 60/50 Hz | TYP | | TYP | MAX | |
| 1 | 0.8 | 0.25 | 6 | 1 | 6 | 1 | 0.1 | 100/83 | 10 | 100 | 4 | 50 | 41 |
| 1 | 0.8 | 0.25 | 6 | 1 | 6 | 1 | 0.1 | 100/83 | 8 | 100 | 4 | 50 | 41 |
| 1 | 0.8 | 0.25 | 6 | 1 | 6 | 1 | 0.1 | 100/83 | 8 | 100 | 4 | 50 | 41 |
| 1 | 0.8 | 0.25 | 8 | 1 | 6 | 1 | 0.1 | 100/83 | 10 | 100 | 5 | 45 | 41 |
| 1 | 0.8 | 0.25 | 8 | 1 | 6 | 1 | 0.1 | 100/83 | 8 | 100 | 5 | 45 | 41 |
| 1 | 0.8 | 0.25 | 8 | 1 | 6 | 1 | 0.1 | 100/83 | 8 | 100 | 5 | 45 | 41 |
| 1 | 0.8 | 0.25 | 6 | 1 | 6 | 1 | 0.1 | 100/83 | 10 | 100 | 4 | 50 | 41 |
| 1 | 0.8 | 0.25 | 6 | 1 | 6 | 1 | 0.1 | 100/83 | 8 | 100 | 4 | 50 | 41 |
| 1 | 0.8 | 0.25 | 6 | 1 | 6 | 1 | 0.1 | 100/83 | 8 | 100 | 4 | 50 | 41 |
| 1 | 0.8 | 0.25 | 8 | 1 | 6 | 1 | 0.1 | 100/83 | 10 | 100 | 5 | 45 | 41 |
| 1 | 0.8 | 0.25 | 8 | 1 | 6 | 1 | 0.1 | 100/83 | 8 | 100 | 5 | 45 | 41 |
| 1 | 0.8 | 0.25 | 8 | 1 | 6 | 1 | 0.1 | 100/83 | 8 | 100 | 5 | 45 | 41 |
| 1 | 0.8 | 0.25 | 6 | 1 | 6 | 1 | 0.1 | 100/83 | 10 | 100 | 4 | 50 | 41 |
| 1 | 0.8 | 0.25 | 6 | 1 | 6 | 1 | 0.1 | 100/83 | 8 | 100 | 4 | 50 | 41 |
| 1 | 0.8 | 0.25 | 6 | 1 | 6 | 1 | 0.1 | 100/83 | 8 | 100 | 4 | 50 | 41 |
| 1 | 0.8 | 0.25 | 8 | 1 | 6 | 1 | 0.1 | 100/83 | 10 | 100 | 5 | 45 | 41 |
| 1 | 0.8 | 0.25 | 8 | 1 | 6 | 1 | 0.1 | 100/83 | 8 | 100 | 5 | 45 | 41 |
| 1 | 0.8 | 0.25 | 8 | 1 | 6 | 1 | 0.1 | 100/83 | 8 | 100 | 5 | 45 | 41 |

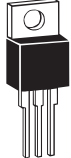
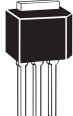
Electrical Specifications Notes

- (1) See Figure E5.1 through Figure E5.9 for current ratings at specified operating temperatures.
- (2) See Figure E5.10 for I_{GT} versus T_C or T_L.
- (3) See Figure E5.11 for instantaneous on-state current (I_T) versus on-state voltage (V_T) TYP.
- (4) See Figure E5.12 for V_{GT} versus T_C or T_L.
- (5) See Figure E5.13 for I_H versus T_C or T_L.
- (6) For more than one full cycle, see Figure E5.14.
- (7) 0.8 A to 4 A devices also have a pulse peak forward current on-state rating (repetitive) of 75 A. This rating applies for operation at 60 Hz, 75 °C maximum tab (or anode) lead temperature, switching from 80 V peak, sinusoidal current pulse width of 10 μs minimum, 15 μs maximum. See Figure E5.20 and Figure E5.21.
- (8) See Figure E5.15 for t_{gt} versus I_{GT}.
- (9) Test conditions as follows:
 - T_C or T_L ≤ 80 °C, rectangular current waveform
 - Rate-of-rise of current ≤ 10 A/μs
 - Rate-of-reversal of current ≤ 5 A/μs
 - I_{TM} = 1 A (50 μs pulse), Repetition Rate = 60 pps
 - V_{RRM} = Rated
 - V_R = 15 V minimum, V_{DRM} = Rated
 - Rate-of-rise reapplied forward blocking voltage = 5 V/μs
 - Gate Bias = 0 V, 100 Ω (during turn-off time interval)
- (10) Test condition is maximum rated RMS current except TO-92 devices are 1.2 A_{PK}; T106/T107 devices are 4 A_{PK}.
- (11) See package outlines for lead form configurations. When ordering special lead forming, add type number as suffix to part number.
- (12) V_D = 6 V dc, R_L = 100 Ω (See Figure E5.19 for simple test circuit for measuring gate trigger voltage and gate trigger current.)
- (13) See Figure E5.1 through Figure E5.9 for maximum allowable case temperature at maximum rated current.
- (14) I_{GT} = 500 μA maximum at T_C = -40 °C for T106 devices
- (15) I_H = 10 mA maximum at T_C = -65 °C for 2N5064 Series and 2N6565 Series devices
- (16) I_H = 6 mA maximum at T_C = -40 °C for T106 devices
- (17) Pulse Width ≤ 10 μs
- (18) I_{GT} = 350 μA maximum at T_C = -65 °C for 2N5064 Series and 2N6565 Series devices
- (19) Latching current can be higher than 20 mA for higher I_{GT} types. Also, latching current can be much higher at -40 °C. See Figure E5.18.
- (20) T_C or T_L = T_J for test conditions in off state
- (21) I_{DRM} and I_{RRM} = 50 μA for 2N5064 and 100 μA for 2N6565 at 125 °C
- (22) TO-92 devices specified at -65 °C instead of -40 °C
- (23) T_C = 110 °C

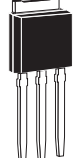
| Thermal Resistance (Steady State) $R_{\theta JC}$ [$R_{\theta JA}$] °C/W (TYPICAL) | | | | | | | |
|---|--|---|--|---|---|--|--|
| Package Code | E | L | F2 | F | C | D | V |
| Type |  TO-92 |  TO-220 |  TO-202 Type 2, 4, & 41 |  TO-202 Type 1 & 3 |  Compak |  TO-252 D-Pak |  TO-251 V-Pak |
| 0.8 A | 75 [160] | | | | 60* | | |
| 1.5 A | 50 [160] | | | | | | |
| 4.0 A | | | 10 [100] | 6.2 [80] | | 3.0 | 3.8 [85] |
| 6.0 A | | 4.0 [65] | | 4.3 | | 1.8 | 2.4 |
| 8.0 A | | 3.4 | | 3.9 | | 1.5 | 2.1 |
| 10.0 A | | 3.0 | | 3.4 | | 1.45 | 1.72 |

*Mounted on 1 cm² copper foil surface; two-ounce copper foil

Electrical Isolation

Tecor's isolated sensitive SCRs will withstand a minimum high potential test of 2500 V ac rms from leads to mounting tab over the device's operating temperature range. The following table shows other standard and optional isolation ratings.

| Electrical Isolation * from Leads to Mounting Tab | |
|--|-------------|
| V AC RMS | TO-220 |
| 2500 | Standard |
| 4000 | Optional ** |

*UL Recognized File #E71639

**For 4000 V isolation, use "V" suffix in part number.

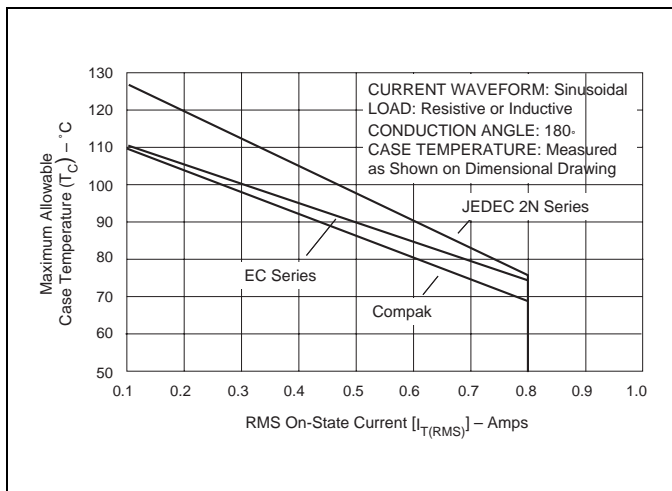

Figure E5.1 Maximum Allowable Case Temperature versus RMS On-state Current

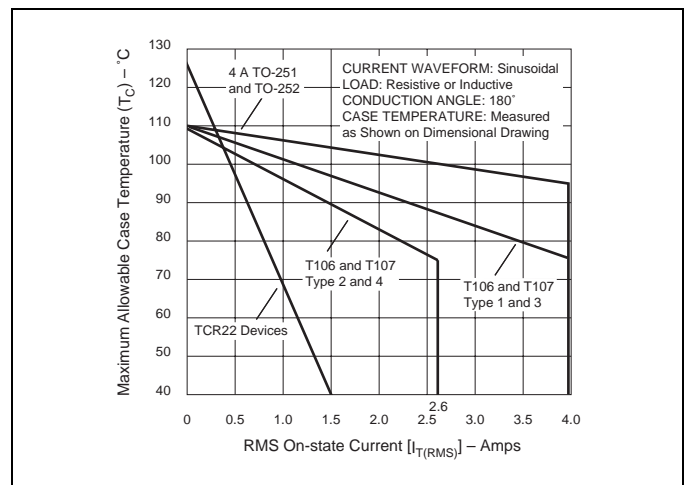

Figure E5.2 Maximum Allowable Case Temperature versus RMS On-state Current

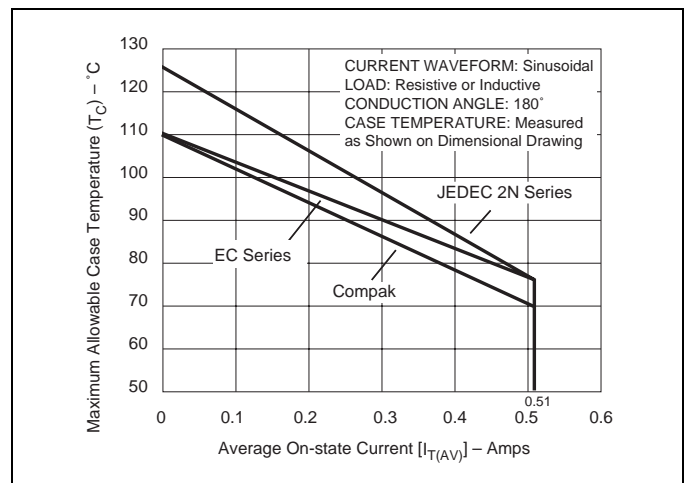

Figure E5.3 Maximum Allowable Case Temperature versus Average On-state Current

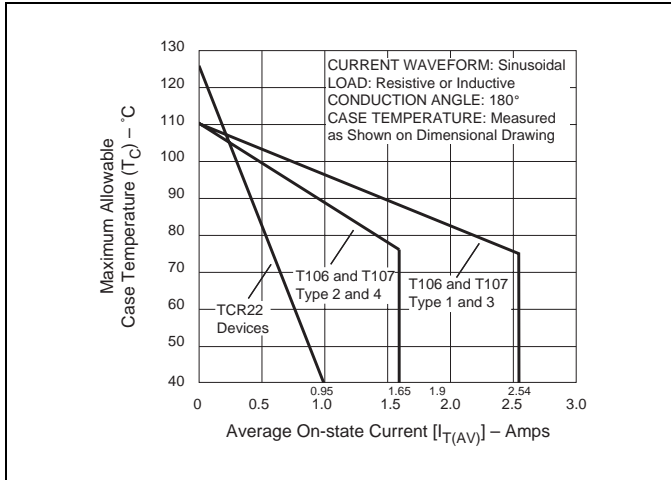

Figure E5.4 Maximum Allowable Case Temperature versus Average On-state Current

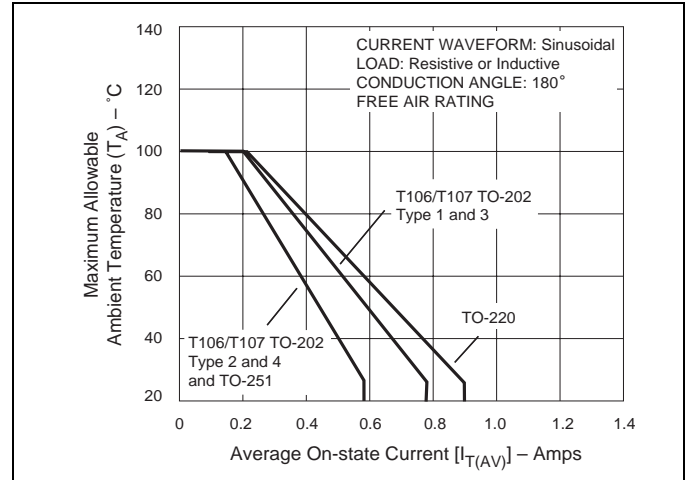

Figure E5.7 Maximum Allowable Ambient Temperature versus Average On-state Current

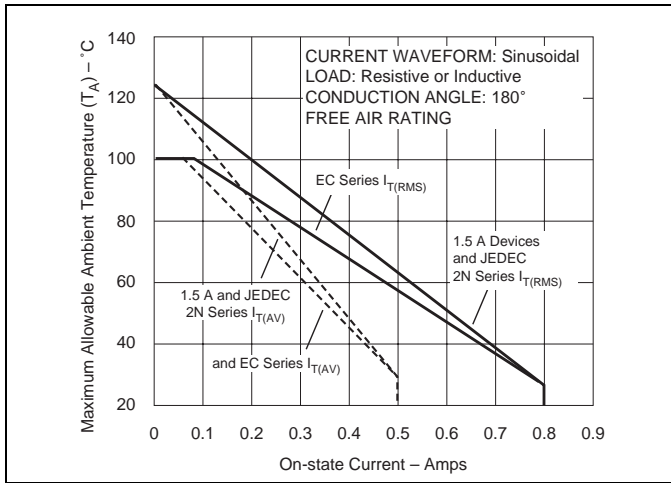

Figure E5.5 Maximum Allowable Ambient Temperature versus On-state Current

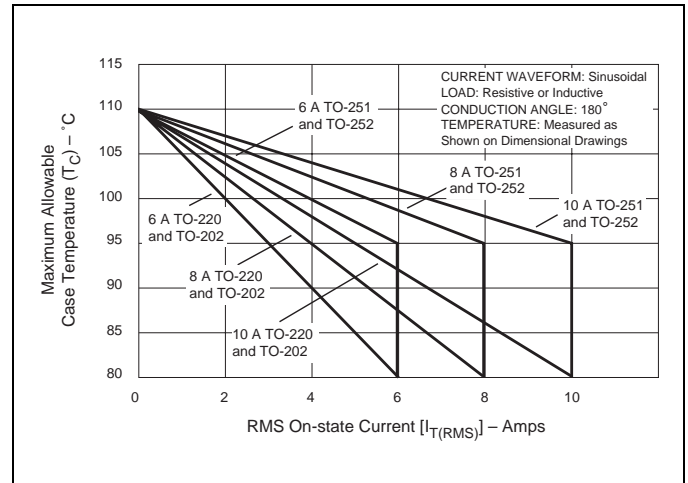

Figure E5.8 Maximum Allowable Case Temperature versus RMS On-state Current

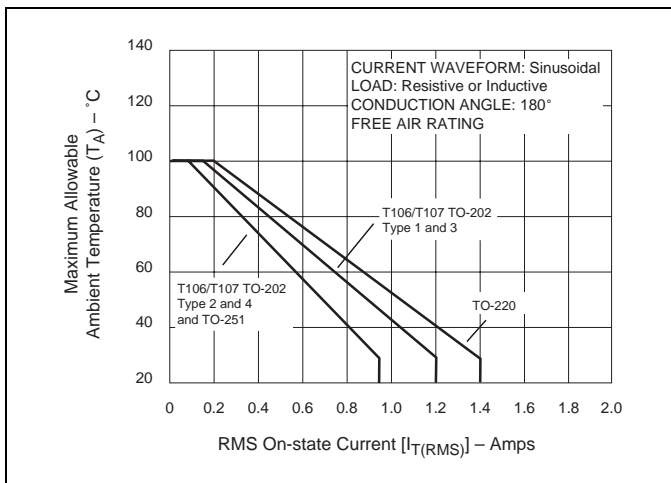

Figure E5.6 Maximum Allowable Ambient Temperature versus RMS On-state Current

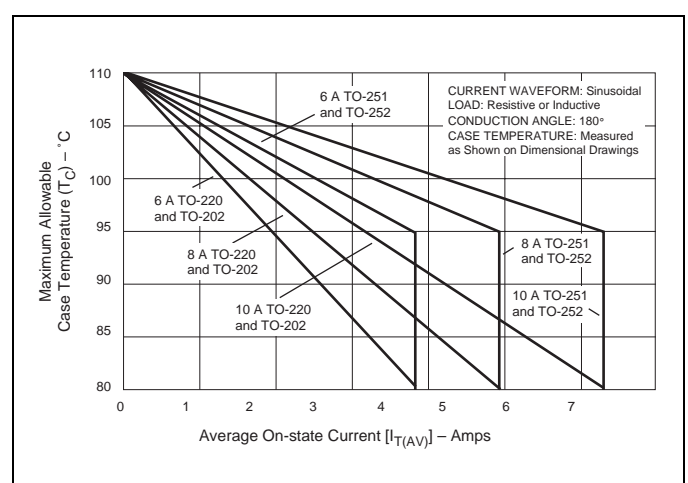

Figure E5.9 Maximum Allowable Case Temperature versus Average On-state Current

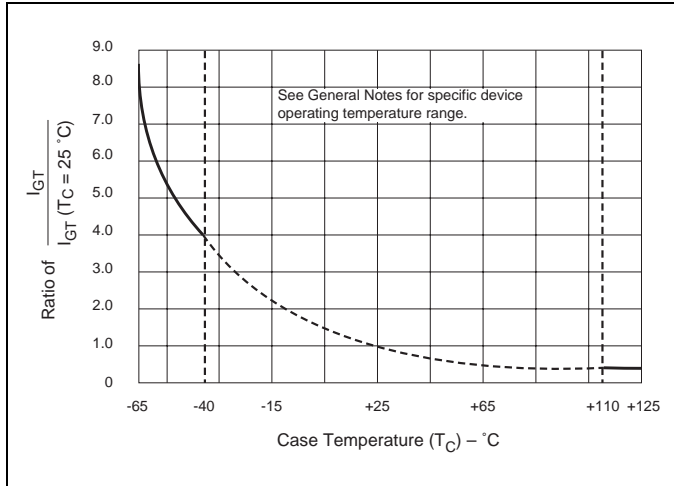

Figure E5.10 Normalized DC Gate-Trigger Current versus Case Temperature

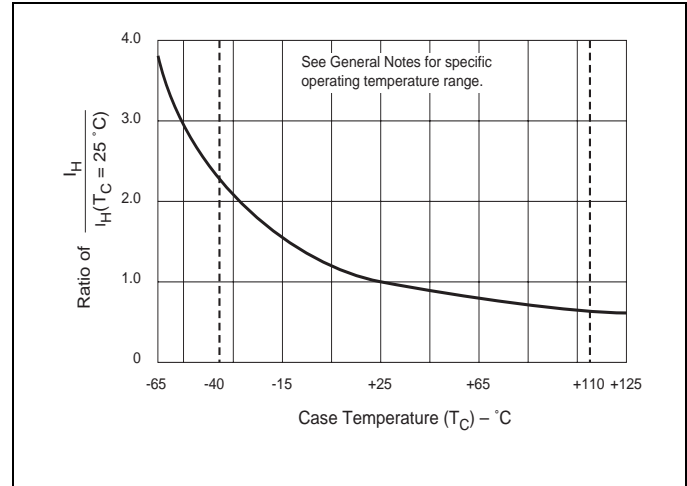

Figure E5.13 Normalized DC Holding Current versus Case Temperature

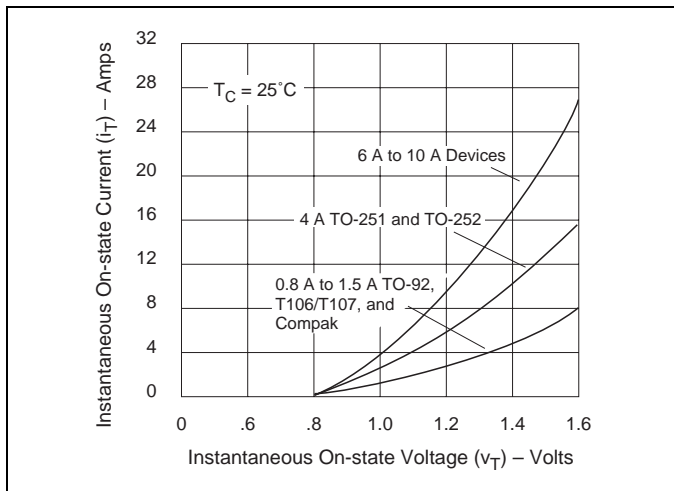

Figure E5.11 Instantaneous On-state Current versus On-state Voltage (Typical)

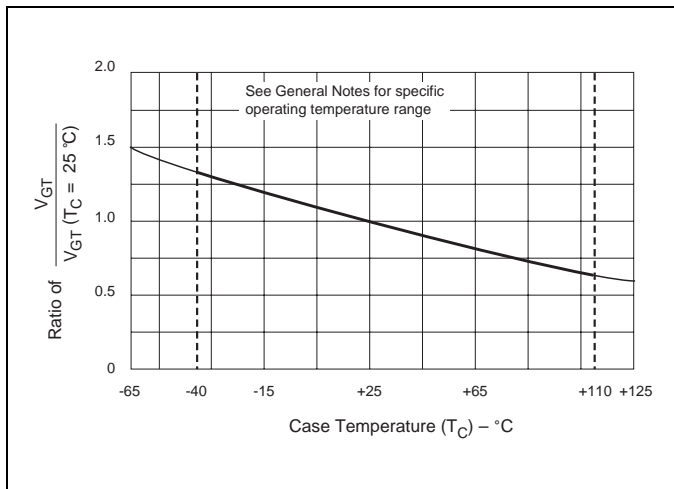

Figure E5.12 Normalized DC Gate-Trigger Voltage versus Case Temperature

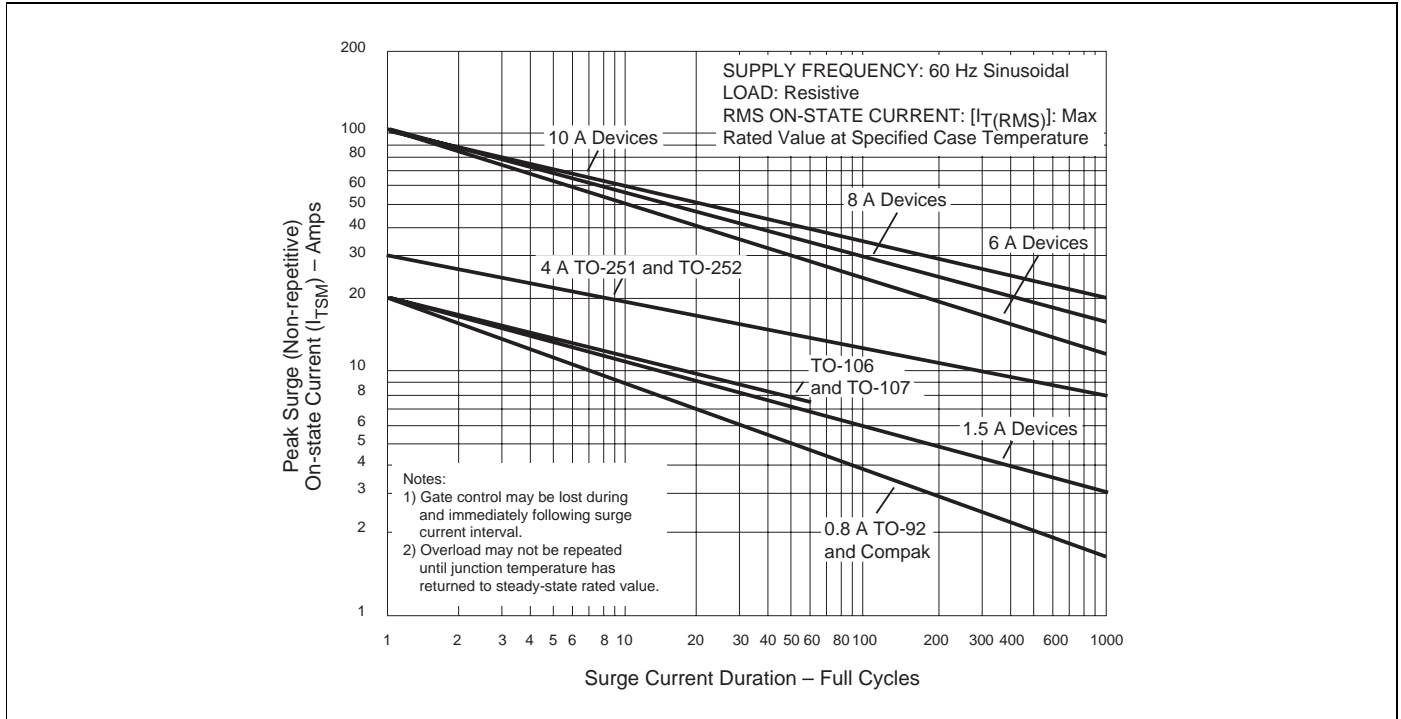

Figure E5.14 Peak Surge On-state Current versus Surge Current Duration

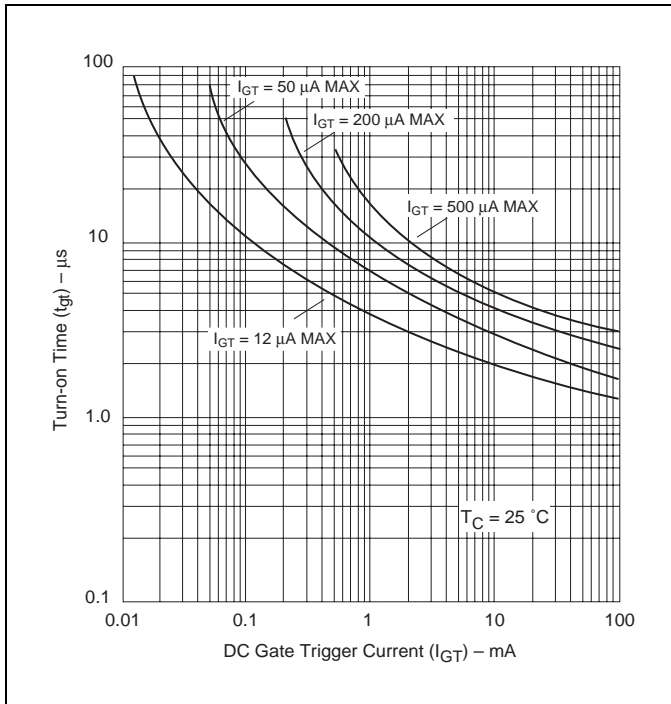

Figure E5.15 Typical Turn-on Time versus Gate Trigger Current

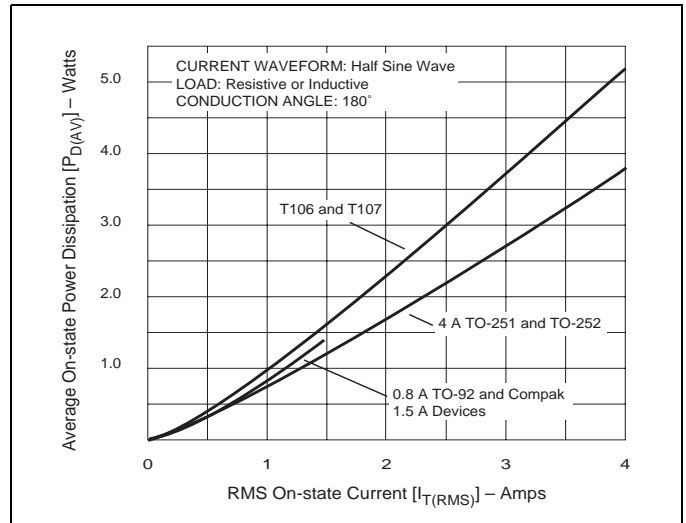

Figure E5.16 Power Dissipation (Typical) versus RMS On-state Current

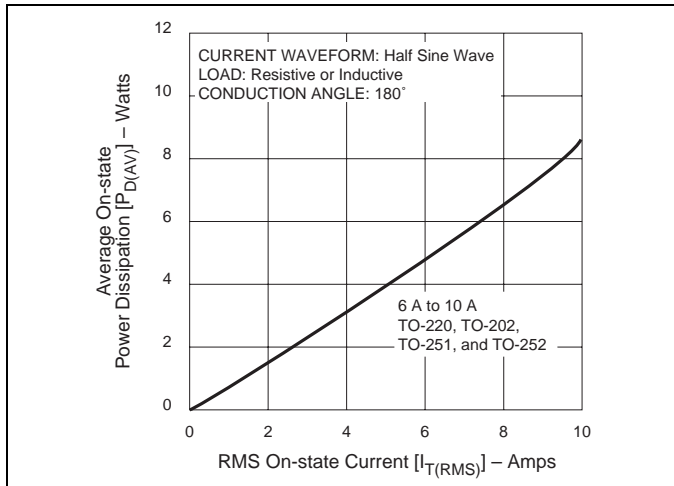

Figure E5.17 Power Dissipation (Typical) versus RMS On-state Current

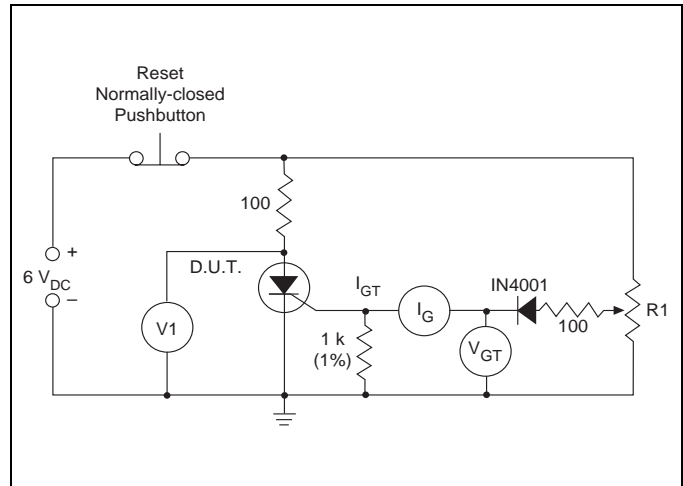

Figure E5.19 Simple Test Circuit for Gate Trigger Voltage and Current Measurement

Note: V1 — 0 V to 10 V dc meter
V_{GT} — 0 V to 1 V dc meter
I_G — 0 mA to 1 mA dc milliammeter
R1 — 1 k potentiometer

To measure gate trigger voltage and current, raise gate voltage (V_{GT}) until meter reading V1 drops from 6 V to 1 V. Gate trigger voltage is the reading on V_{GT} just prior to V1 dropping. Gate trigger current I_{GT} can be computed from the relationship

$$I_{GT} = I_G - \frac{V_{GT}}{1000} \text{ Amps}$$

where I_G is reading (in amperes) on meter just prior to V1 dropping.

Note: I_{GT} may turn out to be a negative quantity (trigger current flows out from gate lead). If negative current occurs, I_{GT} value is not a valid reading. Remove 1 k resistor and use I_G as the more correct I_{GT} value. This will occur on 12 μA gate products.

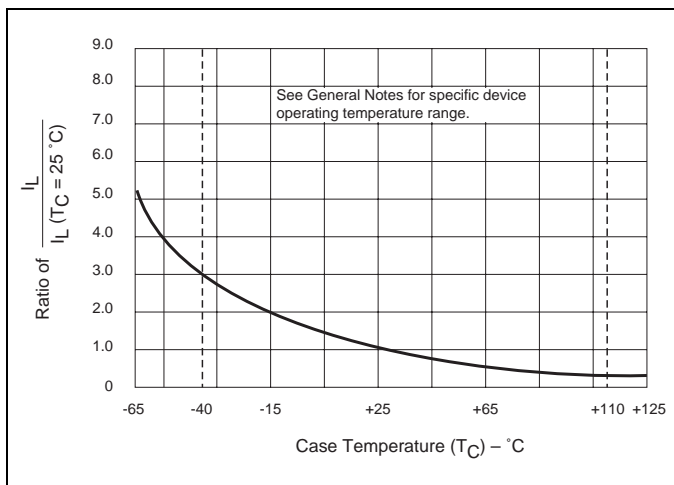

Figure E5.18 Normalized DC Latching Current versus Case Temperature

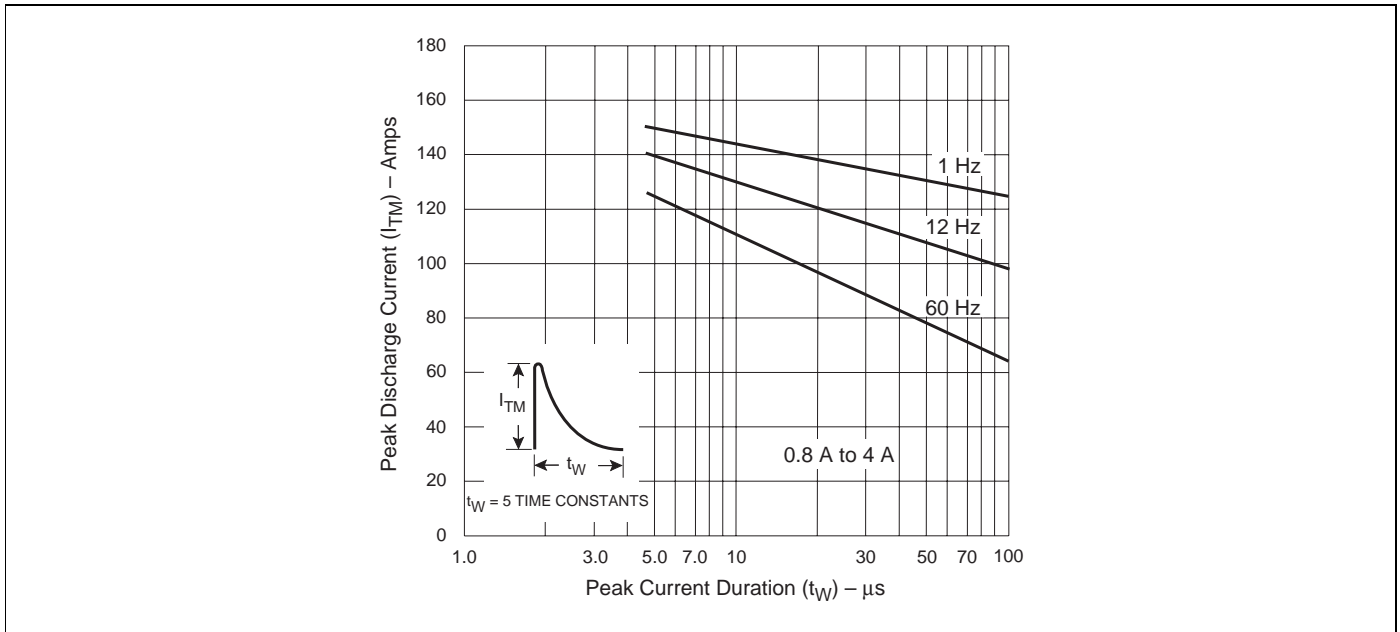

Figure E5.20 Peak Repetitive Capacitor Discharge Current

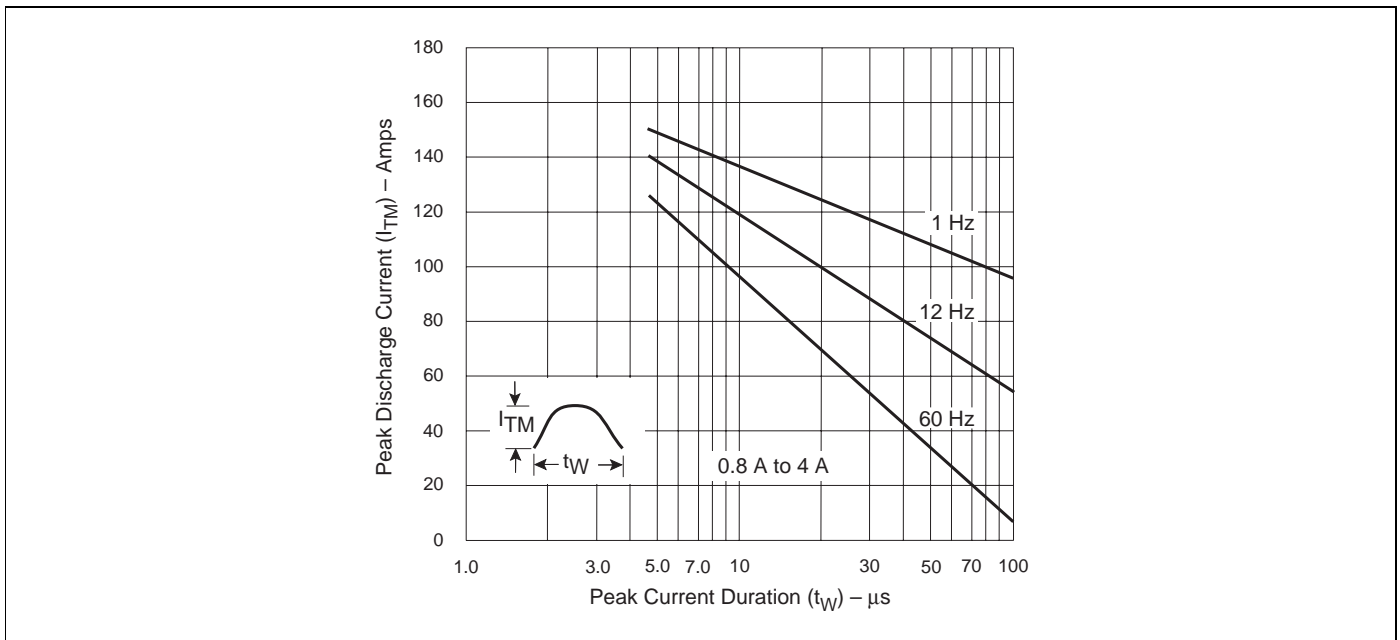

Figure E5.21 Peak Repetitive Sinusoidal Curve

