

High Voltage Positive Voltage Regulators

GENERAL DESCRIPTION

The XC6202 series are highly precise, low power consumption, high voltage input, positive voltage regulators manufactured using CMOS and laser trimming technologies. The XC6202 consists of a current limiter circuit, a driver transistor, a precision reference voltage and an error correction circuit.

Output voltage is selectable in 100mV steps from 1.8V ~ 18V. The series are also compatible with low ESR ceramic capacitors which give added output stability.

Since the current limiter circuit is built-in, the IC is protected against overshoot currents at such times of output shorts etc.

SOT-23 (150mW), SOT-89 (500mW), TO-92 (300mW), SOT-223 (1200mW) and USP-6B (100mW) packages are available.

APPLICATIONS

- Battery powered equipment
- Reference voltage
- Cameras, video cameras
- Palmtops

FEATURES

- Maximum Output Current** : 150mA (within Pd)
- Maximum Operational Voltage** : 20V
- Output Voltage Range** : 1.8V ~ 18V (0.1V increments)
- Highly Accurate** : $\pm 2\%$
- Low Power Consumption** : 10 μ A (TYP.)
- Line Regulation** : 0.01% / V (TYP.)
- Dropout Voltage** : 200mV @ 30mA
670mV @ 100mA
- Operational Temperature Range** : -40 ~ 85
- Low ESR Capacitor Compatible** : Ceramic capacitor
- Current Limiter Circuit Built-In**
- Small Packages** : SOT-23 (150mW),
SOT-89 (500mW),
TO-92 (300mW),
SOT-223 (1200mW),
USP-6B (100mW)

TYPICAL APPLICATION CIRCUIT

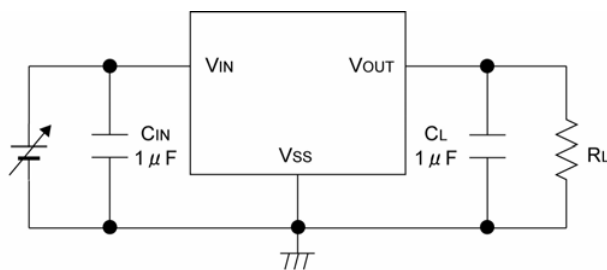

TYPICAL PERFORMANCE CHARACTERISTICS

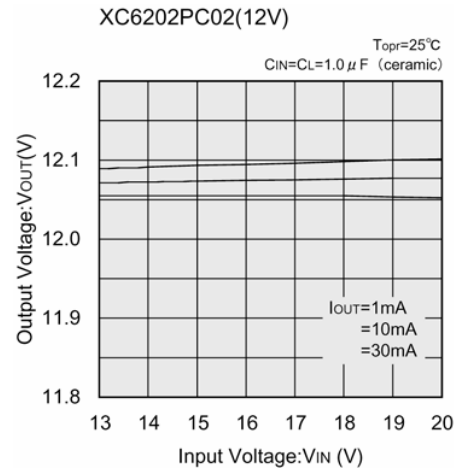

PIN CONFIGURATION

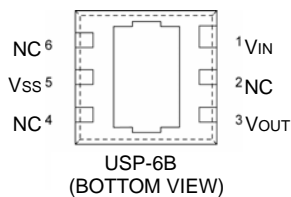
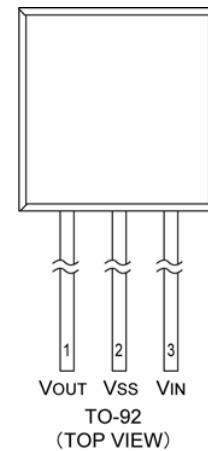
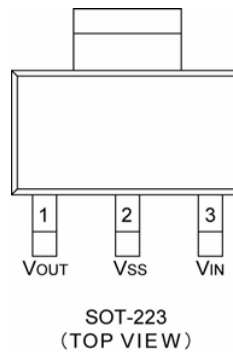
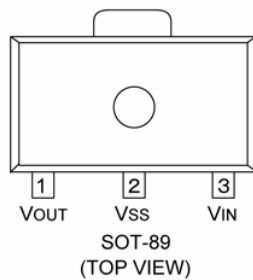
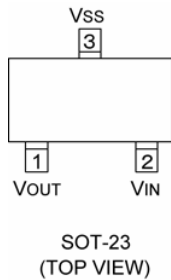

*The dissipation pad for the USP-6B package should be solder-plated in recommended mount pattern and metal masking so as to enhance mounting strength and heat release. If the pad needs to be connected to other pins, it should be connected to the VSS (No.5) pin.

PIN ASSIGNMENT

| PIN NUMBER | | | PIN NAME | FUNCTION |
|------------|--------------------------|---------|----------|---------------|
| SOT-23 | SOT-89/TO-92/ SOT-223 | USP-6B | | |
| 1 | 1 | 3 | VOUT | Output |
| 3 | 2 | 5 | Vss | Ground |
| 2 | 3 | 1 | VIN | Power Input |
| - | - | 2, 4, 6 | NC | No connection |

PRODUCT CLASSIFICATION

Ordering Information

XC6202P

| DESIGNATOR | DESCRIPTION | SYMBOL | DESCRIPTION |
|------------|--------------------|---------|---|
| | Output Voltage | 18 ~ J0 | : For the voltage above 10V, see the example 10=A, 11=B 12=C, 13=D, 14=E, 15=F, 16=G, 17=H, 18=J e.g. VOUT= 3.0V :3, :0 VOUT= 12V :C, :0 VOUT= 15V :F, :0 |
| | Accuracy | 2 | : ± 2% |
| | Packages | M | : SOT-23 |
| | | P | : SOT-89 |
| | | T | : TO-92 |
| | | F | : SOT-223 |
| | | D | : USP-6B |
| | Device Orientation | R | : Embossed tape, standard feed |
| | | L | : Embossed tape, reverse feed |
| | | H | : Paper Tape (TO-92) |
| | | B | : Bag (TO-92) |

BLOCK DIAGRAM

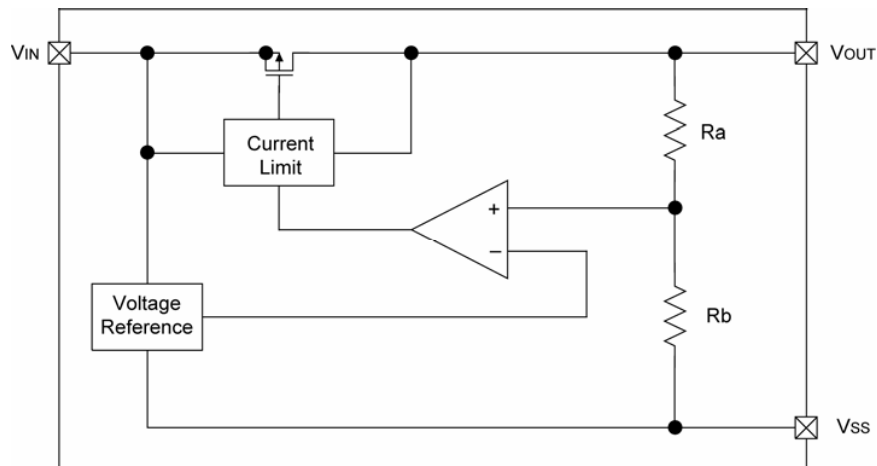

ABSOLUTE MAXIMUM RATINGS

Ta = 25

| PARAMETER | | SYMBOL | RATINGS | UNITS |
|-----------------------------|---------|------------------|---|-------|
| Input Voltage | | V _{IN} | 22.0 | V |
| Output Current | | I _{OUT} | 500 | mA |
| Output Voltage | | V _{OUT} | V _{SS} -0.3 ~ V _{IN} +0.3 | V |
| Power Dissipation | SOT-25 | P _d | 150 | mW |
| | SOT-89 | | 500 | |
| | TO-92 | | 300 | |
| | USP-6B | | 100 | |
| | SOT-223 | | 1,200* | |
| Operating Temperature Range | | T _{opr} | -40 ~ +85 | |
| Storage Temperature Range | | T _{stg} | -55 ~ +125 | |

* Circuits board mounting: Double-sided board

ELECTRICAL CHARACTERISTICS

XC6202P182

$V_{OUT(T)}=1.8V$ ^{(*)1}

$T_{opr}=25$

| PARAMETER | SYMBOL | CONDITIONS | MIN. | TYP. | MAX. | UNITS | CIRCUIT |
|--|---|--|-------|-----------|-------|---------|---------|
| Output Voltage | $V_{OUT(E)}$ ^{(*)2} | $V_{IN}=2.8V$ $I_{OUT}=30mA$ | 1.764 | 1.800 | 1.836 | V | |
| Maximum Output Current | I_{OUTmax} | $V_{IN}=2.8V$ $V_{OUT} < V_{OUT(E)} \times 0.9$ | 60 | - | - | mA | |
| Load Regulation | V_{OUT} | $V_{IN}=2.8V$ $1mA < I_{OUT} < 60mA$ | - | 10 | 80 | mV | |
| Dropout Voltage ^{(*)3} | V_{dif1} | $I_{OUT}=30mA$ | - | 340 | 470 | mV | |
| | V_{dif2} | $I_{OUT}=100mA$ | - | 1000 | 1500 | | |
| Supply Current | I_{SS} | $V_{IN}=2.8V$ | - | 10 | 24 | μA | |
| Line Regulation | $\frac{V_{OUT}}{V_{IN} \cdot V_{OUT}}$ | $I_{OUT}=1mA$ $2.8V < V_{IN} < 20V$ | - | 0.01 | 0.20 | %/V | |
| Input Voltage | V_{IN} | | - | - | 20 | V | - |
| Output Voltage Temperature Characteristics | $\frac{V_{OUT}}{T_{opr} \cdot V_{OUT}}$ | $I_{OUT}=30mA$ $-40 < T_{opr} < 85$ | - | ± 100 | - | ppm/ | |
| Short-circuit Current | I_{short} | $V_{IN}=3.8V$ | - | 40 | - | mA | |

XC6202P332

$V_{OUT(T)}=3.3V$ ^{(*)1}

$T_{opr}=25$

| PARAMETER | SYMBOL | CONDITIONS | MIN. | TYP. | MAX. | UNITS | CIRCUIT |
|--|---|--|-------|-----------|-------|---------|---------|
| Output Voltage | $V_{OUT(E)}$ ^{(*)2} | $V_{IN}=4.3V$ $I_{OUT}=30mA$ | 3.234 | 3.300 | 3.366 | V | |
| Maximum Output Current | I_{OUTmax} | $V_{IN}=4.3V$ $V_{OUT} < V_{OUT(E)} \times 0.9$ | 150 | - | - | mA | |
| Load Regulation | V_{OUT} | $V_{IN}=4.3V$ $1mA < I_{OUT} < 100mA$ | - | 25 | 90 | mV | |
| Dropout Voltage ^{(*)3} | V_{dif1} | $I_{OUT}=30mA$ | - | 200 | 280 | mV | |
| | V_{dif2} | $I_{OUT}=100mA$ | - | 670 | 900 | | |
| Supply Current | I_{SS} | $V_{IN}=4.3V$ | - | 10 | 24 | μA | |
| Line Regulation | $\frac{V_{OUT}}{V_{IN} \cdot V_{OUT}}$ | $I_{OUT}=1mA$ $4.3V < V_{IN} < 20V$ | - | 0.01 | 0.20 | %/V | |
| Input Voltage | V_{IN} | | - | - | 20 | V | - |
| Output Voltage Temperature Characteristics | $\frac{V_{OUT}}{T_{opr} \cdot V_{OUT}}$ | $I_{OUT}=30mA$ $-40 < T_{opr} < 85$ | - | ± 100 | - | ppm/ | |
| Short-circuit Current | I_{short} | $V_{IN}=5.3V$ | - | 40 | - | mA | |

ELECTRICAL CHARACTERISTICS (Continued)

XC6202P502 $V_{OUT(T)}=5.0V$ ^(*)

$T_{opr}=25$

| PARAMETER | SYMBOL | CONDITIONS | MIN. | TYP. | MAX. | UNITS | CIRCUIT |
|--|---|--|-------|-----------|------|---------|---------|
| Output Voltage | $V_{OUT(E)}$ ^(**) | $V_{IN}=6V$ $I_{OUT}=30mA$ | 4.900 | 5.000 | 5100 | V | |
| Maximum Output Current | I_{OUTmax} | $V_{IN}=6V$ $V_{OUT} < V_{OUT(E)} \times 0.9$ | 200 | - | - | mA | |
| Load Regulation | V_{OUT} | $V_{IN}=6V$ $1mA < I_{OUT} < 100mA$ | - | 30 | 100 | mV | |
| Dropout Voltage ^(**3) | V_{dif1} | $I_{OUT}=30mA$ | - | 130 | 190 | mV | |
| | V_{dif2} | $I_{OUT}=100mA$ | - | 440 | 550 | | |
| Supply Current | I_{SS} | $V_{IN}=6V$ | - | 10 | 24 | μA | |
| Line Regulation | $\frac{V_{OUT}}{V_{IN} \cdot V_{OUT}}$ | $I_{OUT}=1mA$ $6V < V_{IN} < 20V$ | - | 0.01 | 0.20 | %/V | |
| Input Voltage | V_{IN} | | - | - | 20 | V | - |
| Output Voltage Temperature Characteristics | $\frac{V_{OUT}}{T_{opr} \cdot V_{OUT}}$ | $I_{OUT}=30mA$ $-40 < T_{opr} < 85$ | - | ± 100 | - | ppm/ | |
| Short-circuit Current | I_{short} | $V_{IN}=7V$ | - | 40 | - | mA | |

XC6202PC02 $V_{OUT(T)}=12V$ ^(*)

$T_{opr}=25$

| PARAMETER | SYMBOL | CONDITIONS | MIN. | TYP. | MAX. | UNITS | CIRCUIT |
|--|---|---|--------|-----------|--------|---------|---------|
| Output Voltage | $V_{OUT(E)}$ ^(**) | $V_{IN}=13V$ $I_{OUT}=30mA$ | 11.760 | 12.000 | 12.240 | V | |
| Maximum Output Current | I_{OUTmax} | $V_{IN}=13V$ $V_{OUT} < V_{OUT(E)} \times 0.9$ | 200 | - | - | mA | |
| Load Regulation | V_{OUT} | $V_{IN}=13V$ $1mA < I_{OUT} < 100mA$ | - | 60 | 230 | mV | |
| Dropout Voltage ^(**3) | V_{dif1} | $I_{OUT}=30mA$ | - | 90 | 150 | mV | |
| | V_{dif2} | $I_{OUT}=100mA$ | - | 290 | 380 | | |
| Supply Current | I_{SS} | $V_{IN}=13V$ | - | 12 | 28 | μA | |
| Line Regulation | $\frac{V_{OUT}}{V_{IN} \cdot V_{OUT}}$ | $I_{OUT}=1mA$ $13V < V_{IN} < 20V$ | - | 0.01 | 0.20 | %/V | |
| Input Voltage | V_{IN} | | - | - | 20 | V | - |
| Output Voltage Temperature Characteristics | $\frac{V_{OUT}}{T_{opr} \cdot V_{OUT}}$ | $I_{OUT}=30mA$ $-40 < T_{opr} < 85$ | - | ± 100 | - | ppm/ | |
| Short-circuit Current | I_{short} | $V_{IN}=14V$ | - | 40 | - | mA | |

ELECTRICAL CHARACTERISTICS (Continued)

XC6202PJ02

$V_{OUT(T)}=18V$ ⁽¹⁾

$T_{opr}=25$

| PARAMETER | SYMBOL | CONDITIONS | MIN. | TYP. | MAX. | UNITS | CIRCUIT |
|--|---|---|--------|-----------|--------|---------|---------|
| Output Voltage | $V_{OUT(E)}$ ⁽²⁾ | $V_{IN}=19V$ $I_{OUT}=30mA$ | 17.640 | 18.000 | 18.360 | V | |
| Maximum Output Current | I_{OUTmax} | $V_{IN}=19V$ $V_{OUT} = V_{OUT(E)} \times 0.9$ | 200 | - | - | mA | |
| Load Regulation | V_{OUT} | $V_{IN}=19V$ $1mA \leq I_{OUT} \leq 100mA$ | - | 120 | 380 | mV | |
| Dropout Voltage ⁽³⁾ | V_{dif1} | $I_{OUT}=30mA$ | - | 80 | 150 | mV | |
| | V_{dif2} | $I_{OUT}=100mA$ | - | 280 | 380 | | |
| Supply Current | I_{SS} | $V_{IN}=19V$ | - | 15 | 30 | μA | |
| Line Regulation | $\frac{V_{OUT}}{V_{IN} \cdot V_{OUT}}$ | $I_{OUT}=1mA$ $19V \leq V_{IN} \leq 20V$ | - | 0.01 | 0.20 | %/V | |
| Input Voltage | V_{IN} | | - | - | 20 | V | - |
| Output Voltage Temperature Characteristics | $\frac{V_{OUT}}{T_{opr} \cdot V_{OUT}}$ | $I_{OUT}=30mA$ $-40 \leq T_{opr} \leq 85$ | - | ± 100 | - | ppm/ | |
| Short-circuit Current | I_{short} | $V_{IN}=20V$ | - | 40 | - | mA | |

*1. $V_{OUT(T)}$ = Specified output voltage.

*2. $V_{OUT(E)}$ = Effective output voltage (i.e. the output voltage when " $V_{OUT(T)}+1.0V$ " is provided at the V_{IN} pin while maintaining certain I_{OUT} value).

*3. $V_{dif} = \{V_{IN1}^{(5)} - V_{OUT1}^{(4)}\}$

*4. V_{OUT1} = A voltage equal to 98% of the output voltage when " $V_{OUT(T)} + 1.0V$ " is input.

*5. V_{IN1} = The input voltage when V_{OUT1} is output following a gradual decrease in the input voltage.

TEST CIRCUITS

CIRCUIT

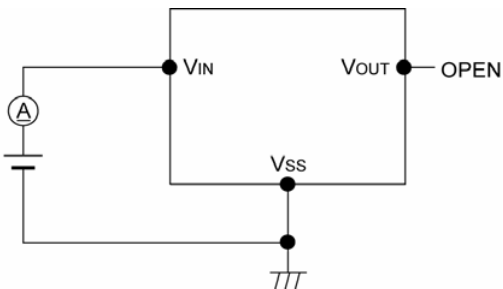

CIRCUIT

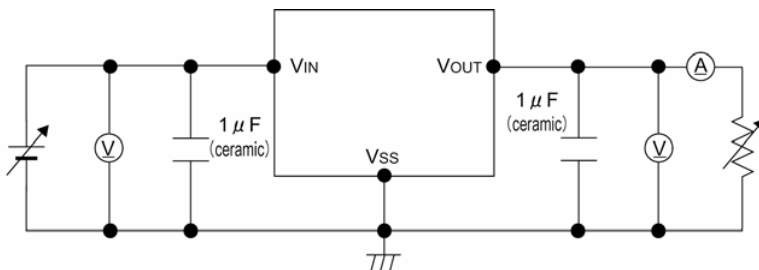

TYPICAL PERFORMANCE CHARACTERISTICS

XC6202P182

(1) Output Voltage vs. Output Current

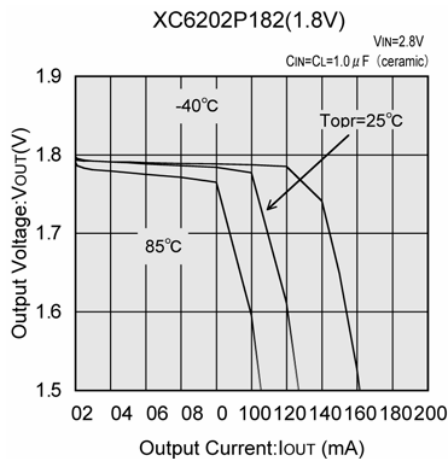

(2) Output Voltage vs. Input Voltage

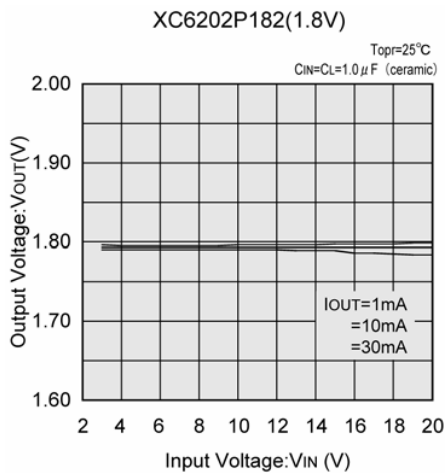
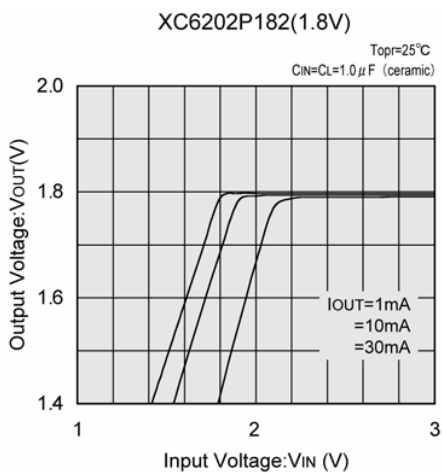

(3) Dropout Voltage vs. Output Current

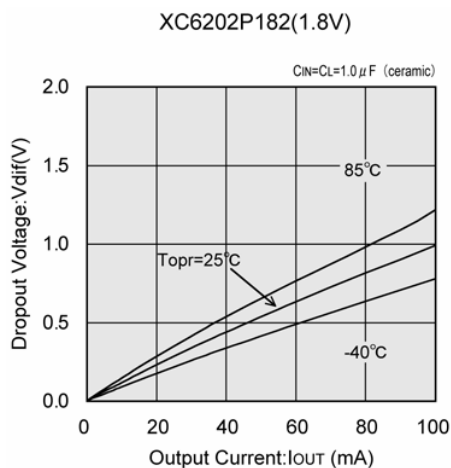

TYPICAL PERFORMANCE CHARACTERISTICS (Continued)

XC6202P182 (Continued)

(4) Supply Current vs. Input Voltage

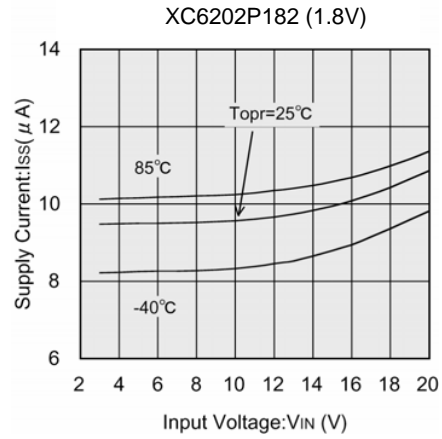
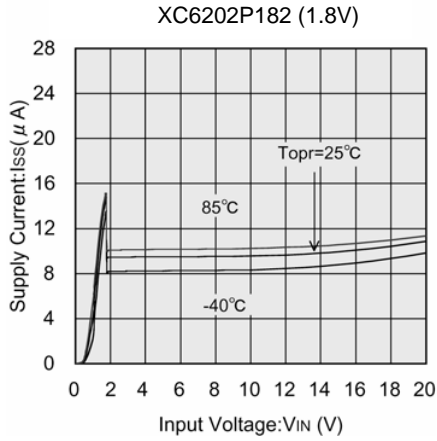

(5) Output Voltage vs. Ambient Temperature

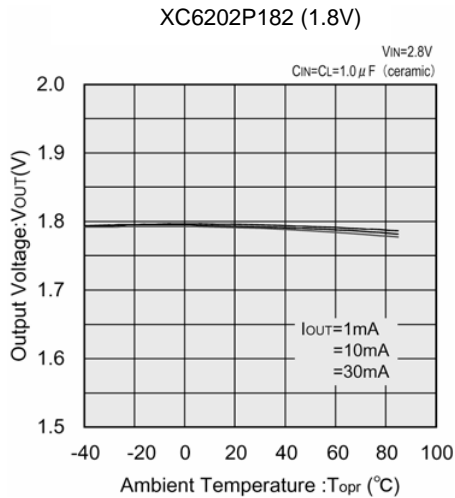

(6) Supply Current vs. Ambient Temperature

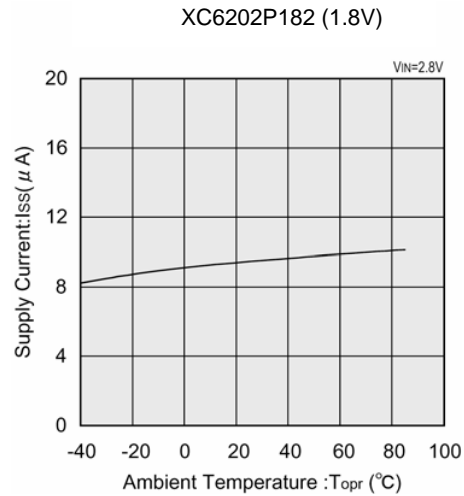

(7) Current Limiter Circuit

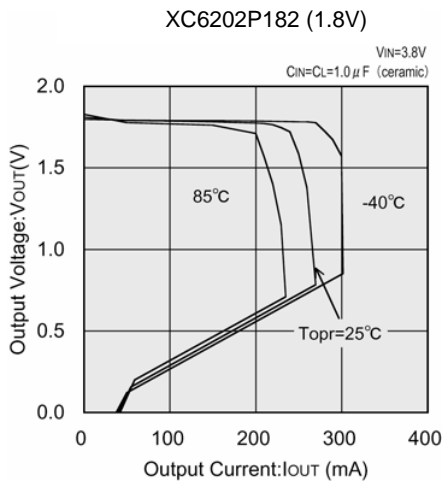

TYPICAL PERFORMANCE CHARACTERISTICS (Continued)

XC6202P182 (Continued)

(8) Input Transient Response 1

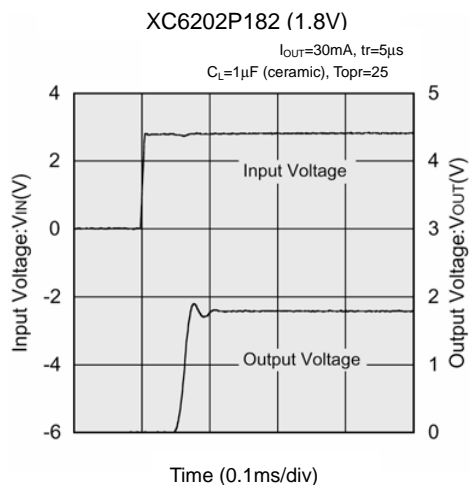
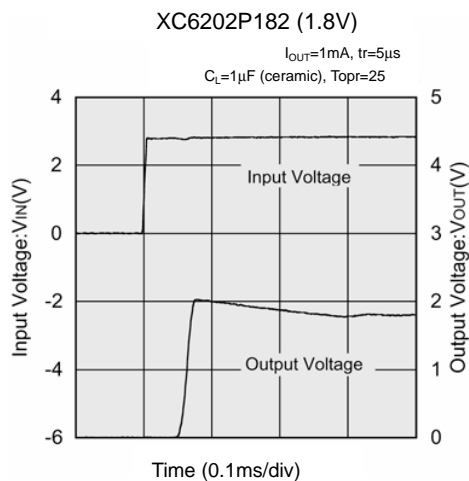

(9) Input Transient Response 2

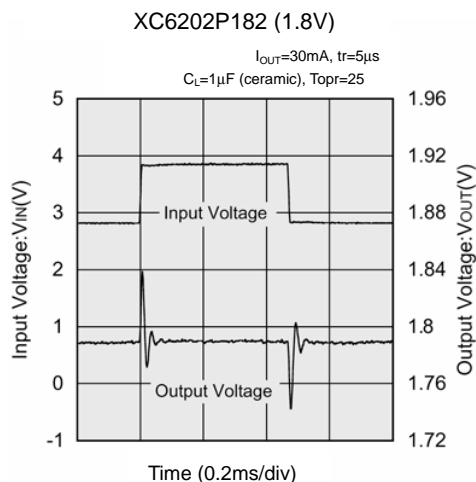
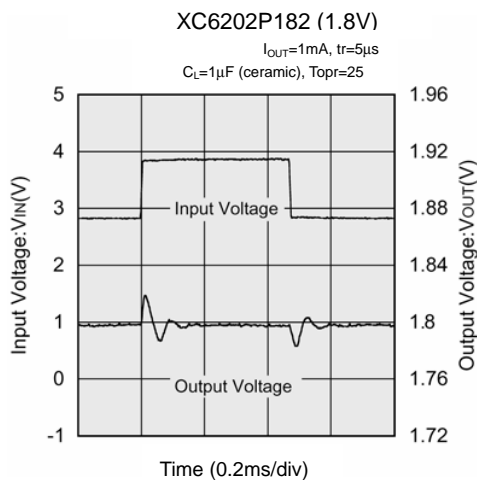

(10) Load Transient Response

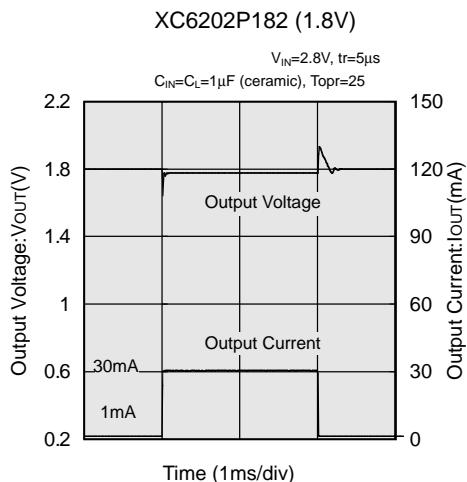

TYPICAL PERFORMANCE CHARACTERISTICS (Continued)

XC6202P182 (Continued)

(11) Ripple Rejection Rate

XC6202P182 (1.8V)

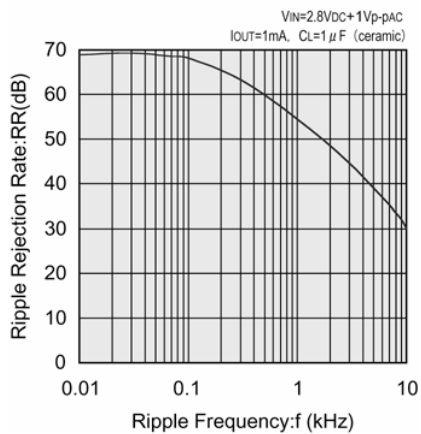

XC6202P182 (1.8V)

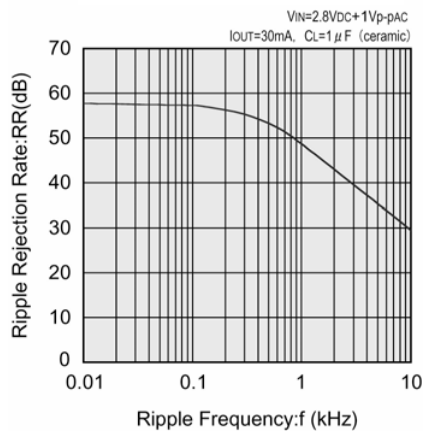

XC6202P182 (1.8V)

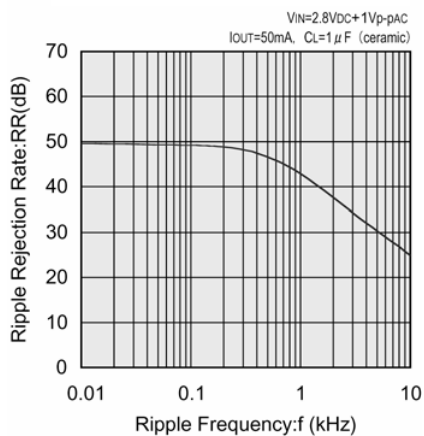

TYPICAL PERFORMANCE CHARACTERISTICS (Continued)

XC6202P332

(1) Output Voltage vs. Output Current

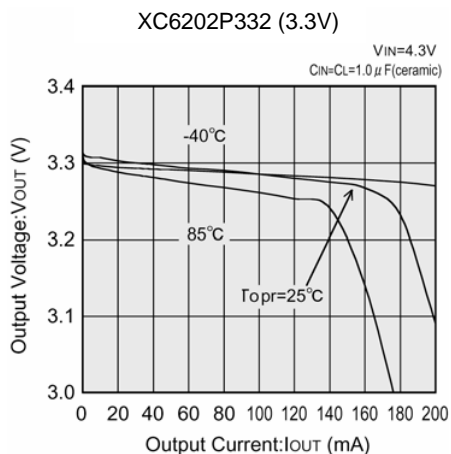

(2) Output Voltage vs. Input Voltage

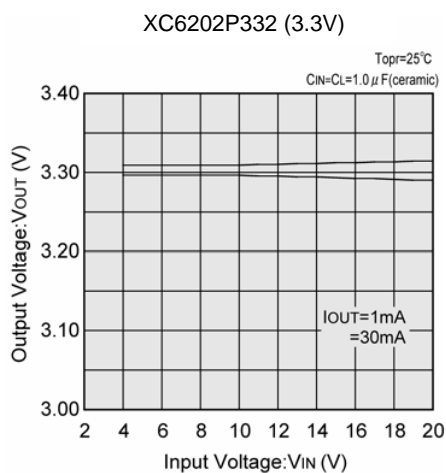
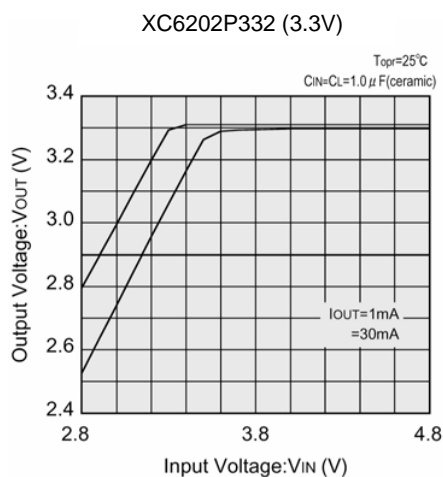

(3) Dropout Voltage vs. Output Current

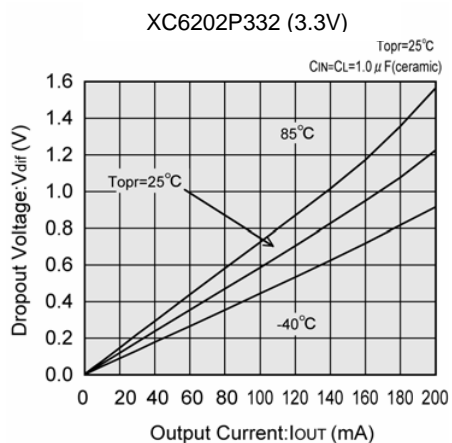

TYPICAL PERFORMANCE CHARACTERISTICS (Continued)

XC6202P332 (Continued)

(4) Supply Current vs. Input Voltage

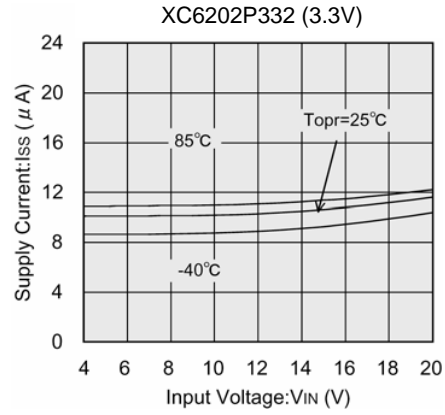
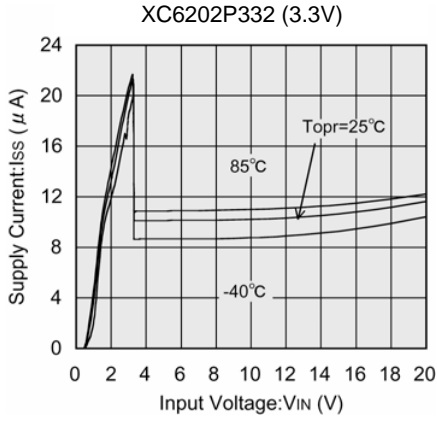

(5) Output Voltage vs. Ambient Temperature

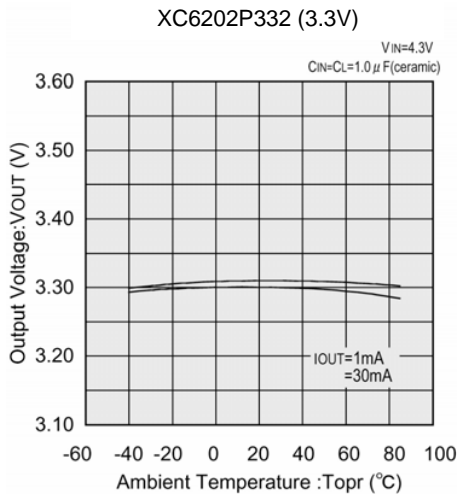

(6) Supply Current vs. Ambient Temperature

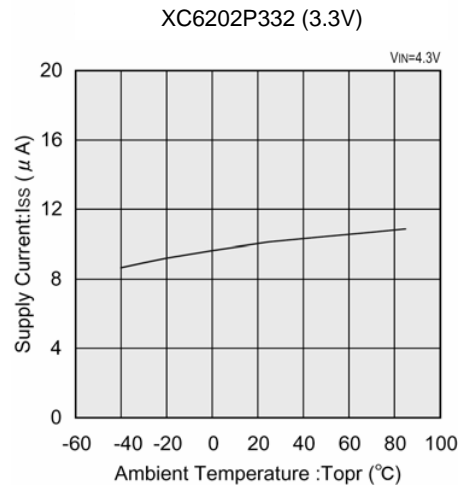

(7) Current Limiter Circuit

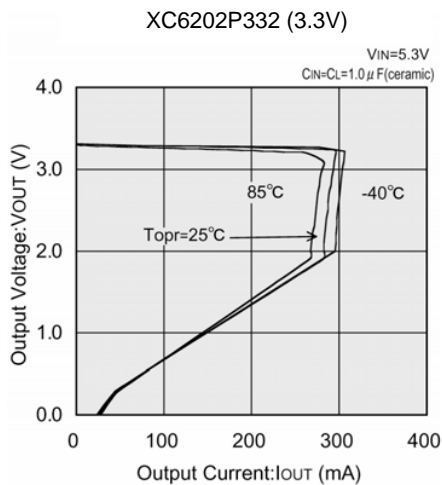

TYPICAL PERFORMANCE CHARACTERISTICS (Continued)

XC6202P332 (Continued)

(8) Input Transient Response 1

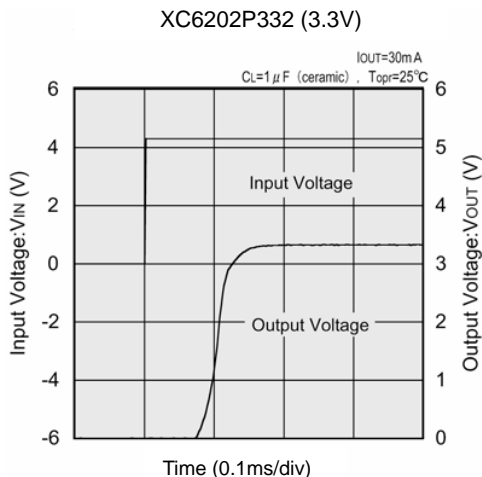

(9) Input Transient Response 2

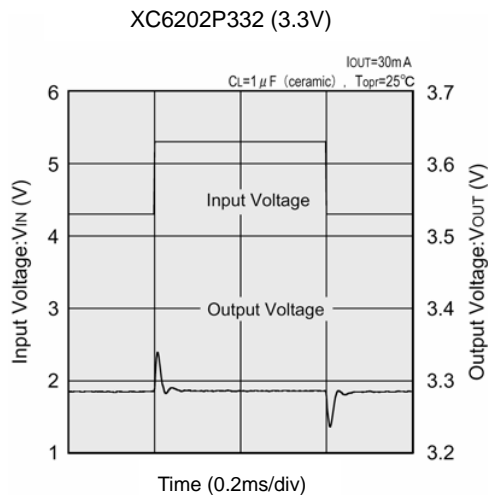
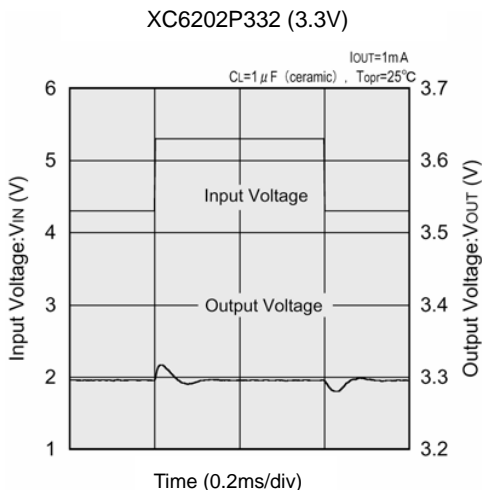

(10) Load Transient Response

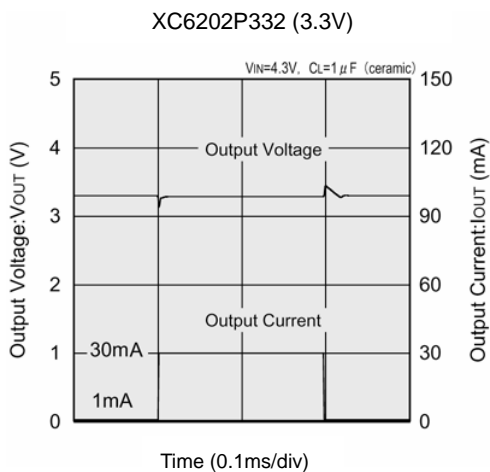

TYPICAL PERFORMANCE CHARACTERISTICS (Continued)

XC6202P332 (Continued)

(11) Ripple Rejection Rate

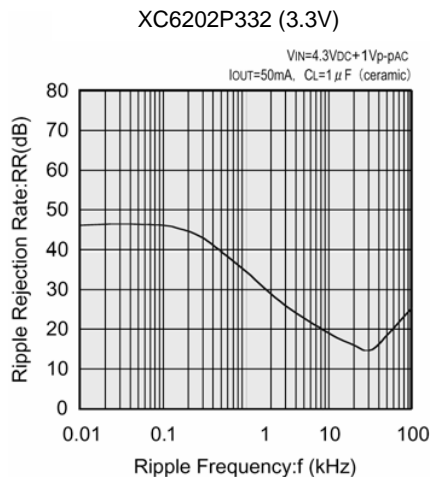
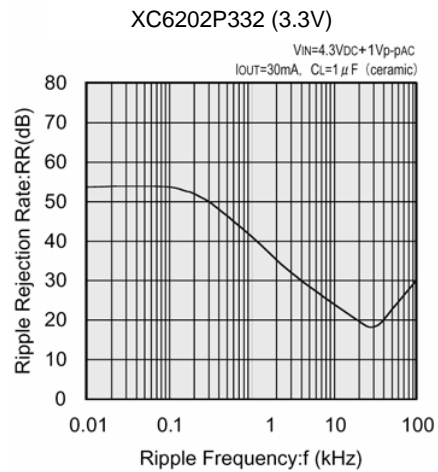
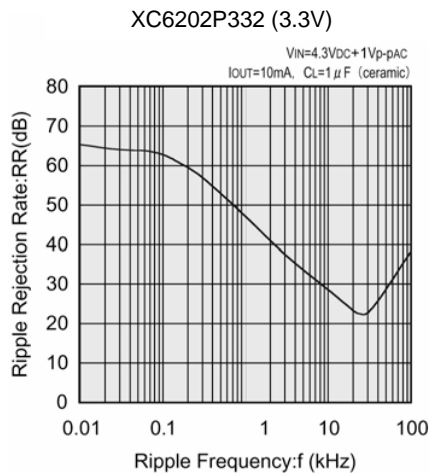
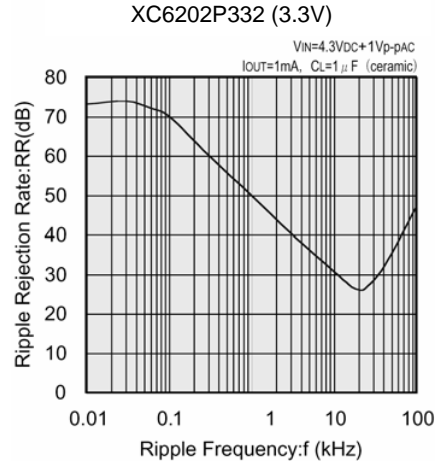
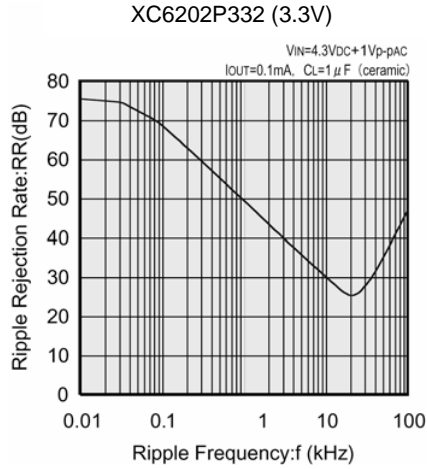

TYPICAL PERFORMANCE CHARACTERISTICS (Continued)

XC6202P502

(1) Output Voltage vs. Output Current

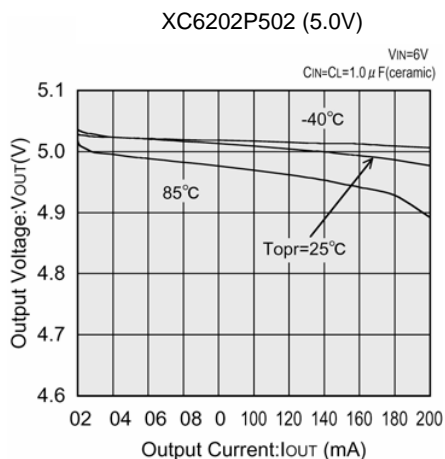

(2) Output Voltage vs. Input Voltage

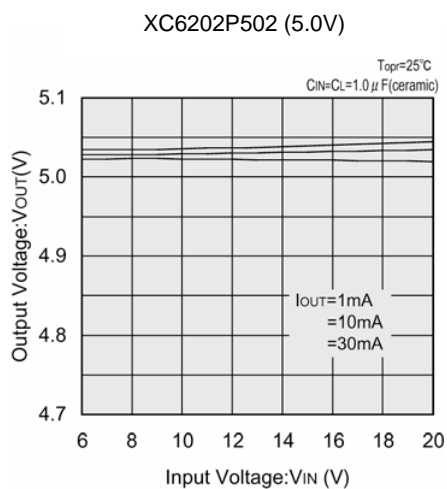
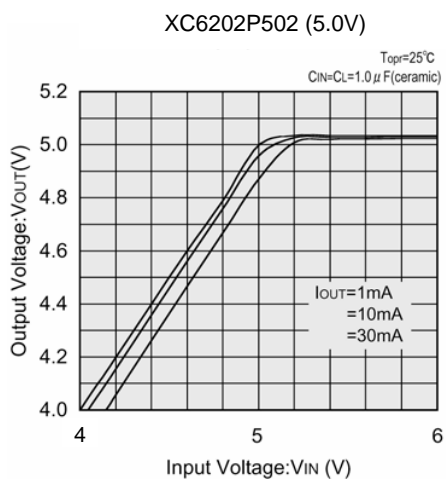

(3) Dropout Voltage vs. Output Current

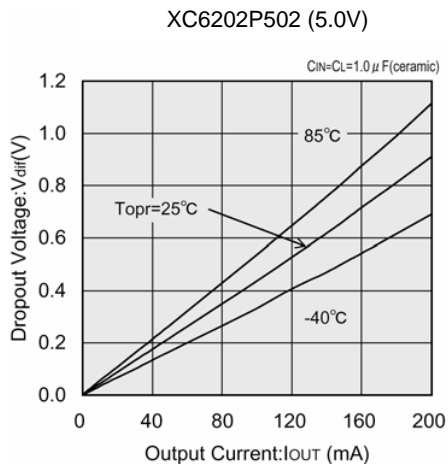

TYPICAL PERFORMANCE CHARACTERISTICS (Continued)

XC6202P502 (Continued)

(4) Supply Current vs. Input Voltage

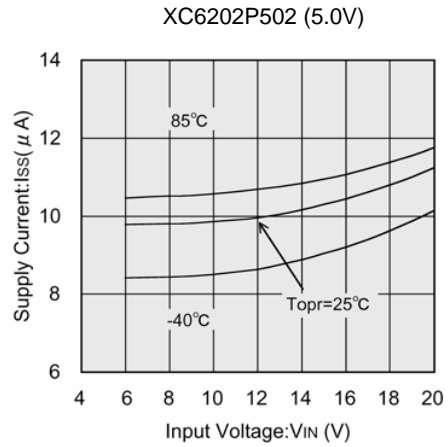
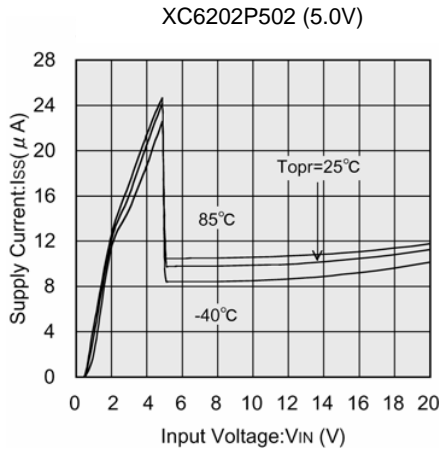

(5) Output Voltage vs. Ambient Temperature

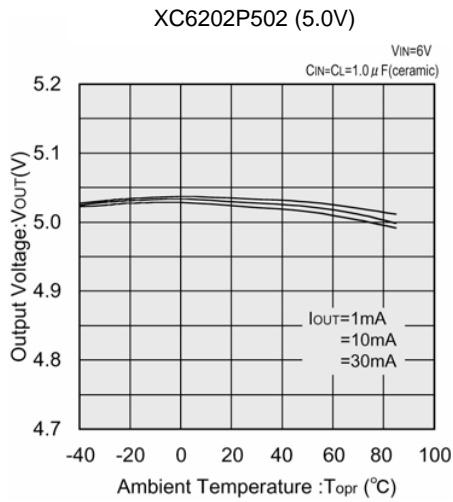

(6) Supply Current vs. Ambient Temperature

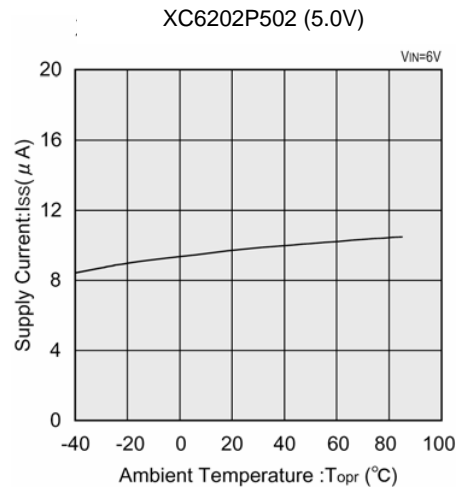

(7) Current Limiter Circuit

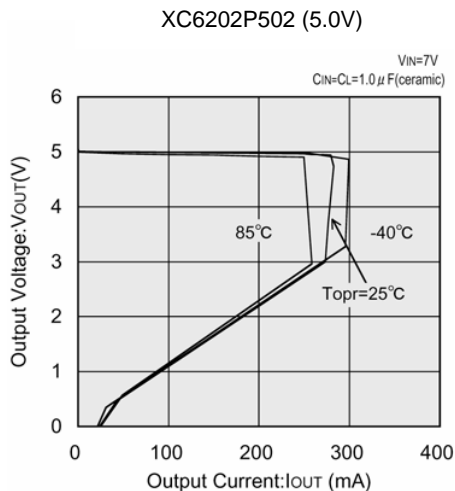

TYPICAL PERFORMANCE CHARACTERISTICS (Continued)

XC6202P502 (Continued)

(8) Input Transient Response 1

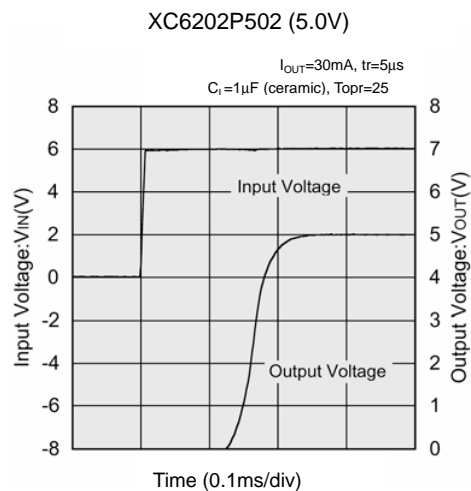
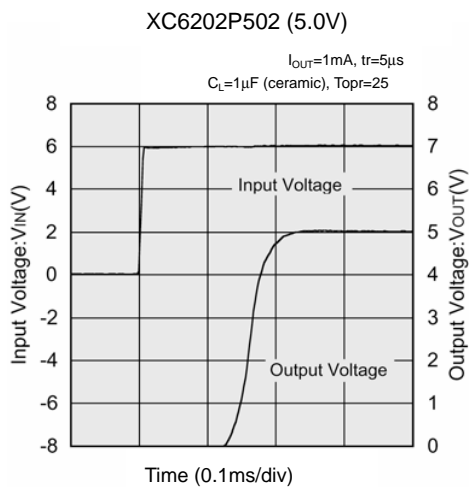

(9) Input Transient Response 2

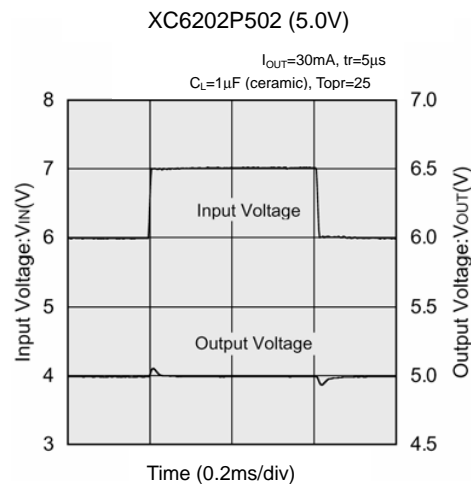
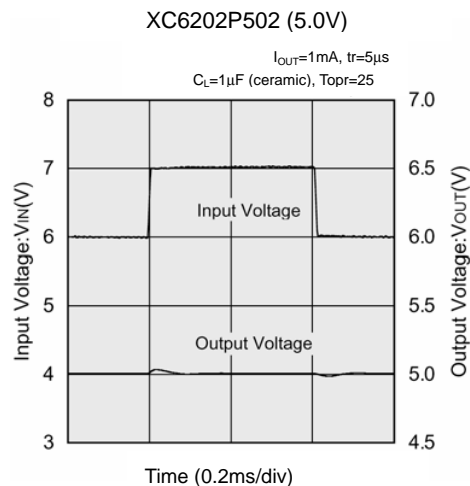

(10) Load Transient Response

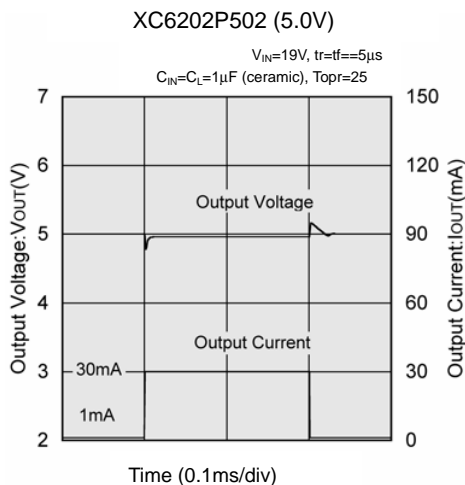

TYPICAL PERFORMANCE CHARACTERISTICS (Continued)

XC6202P502 (Continued)

(11) Ripple Rejection Rate

XC6202P502 (5.0V)

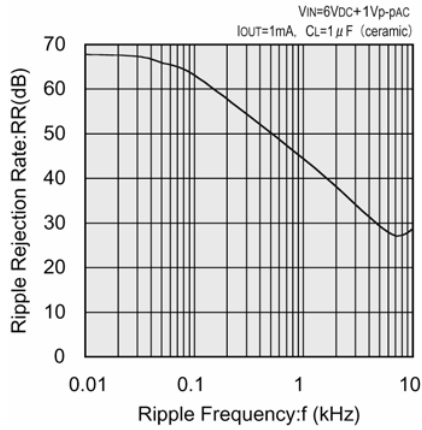

XC6202P502 (5.0V)

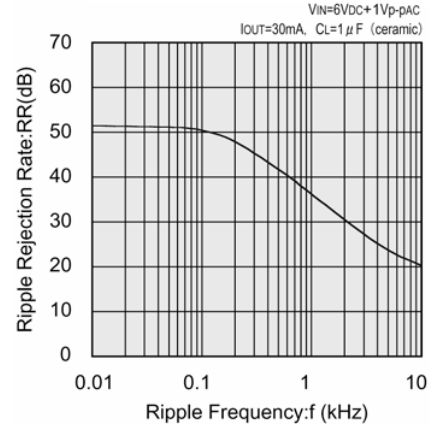

XC6202P502 (5.0V)

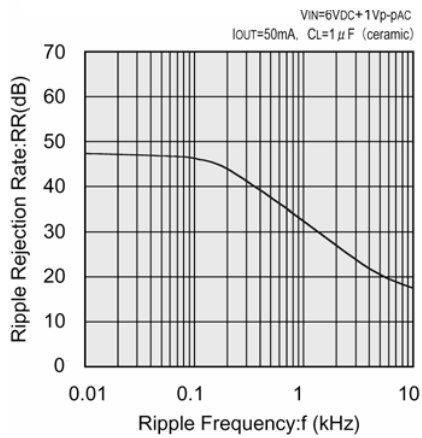

TYPICAL PERFORMANCE CHARACTERISTICS (Continued)

XC6202PC02

(1) Output Voltage vs. Output Current

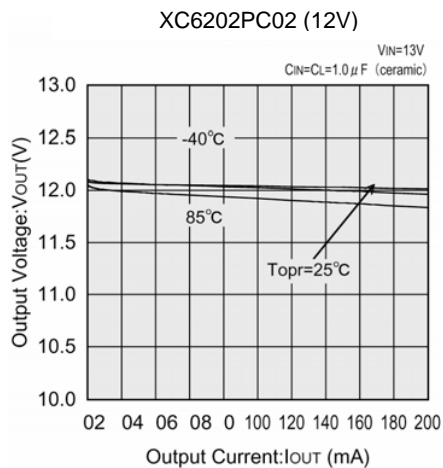

(2) Output Voltage vs. Input Voltage

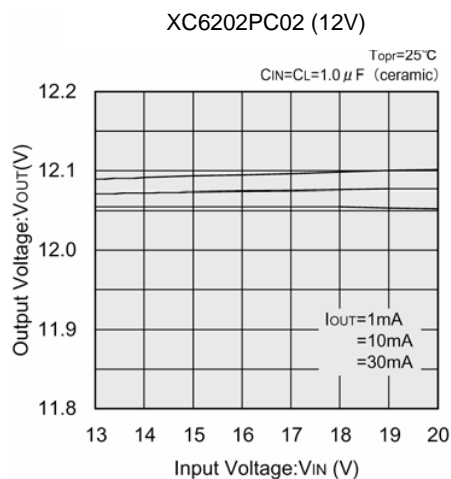
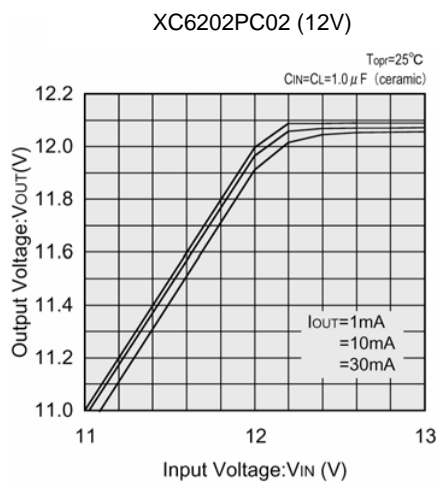

(3) Dropout Voltage vs. Output Current

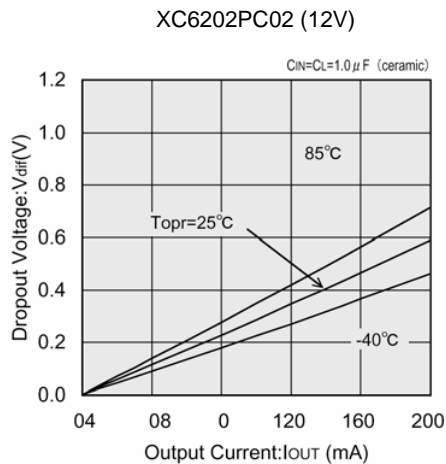

TYPICAL PERFORMANCE CHARACTERISTICS (Continued)

XC6202PC02 (Continued)

(4) Supply Current vs. Input Voltage

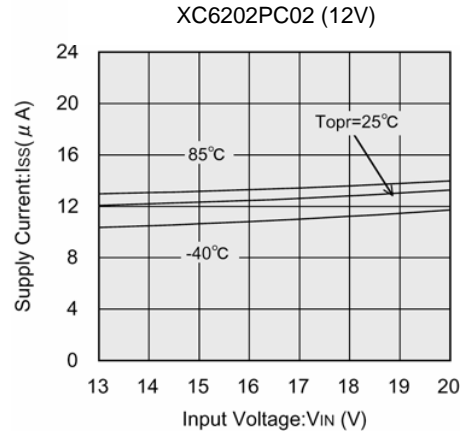
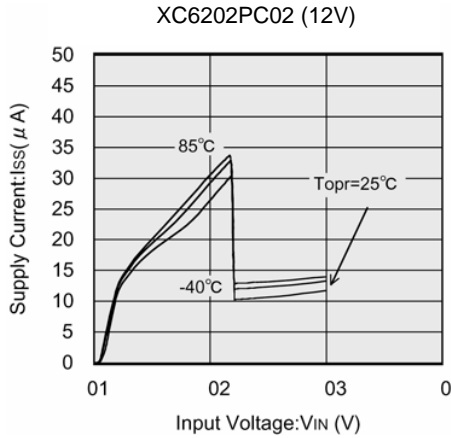

(5) Output Voltage vs. Ambient Temperature

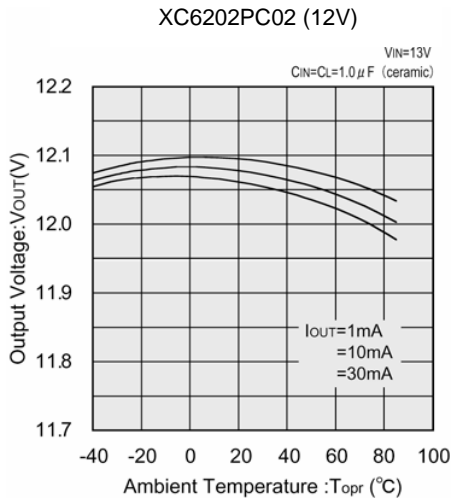

(6) Supply Current vs. Ambient Temperature

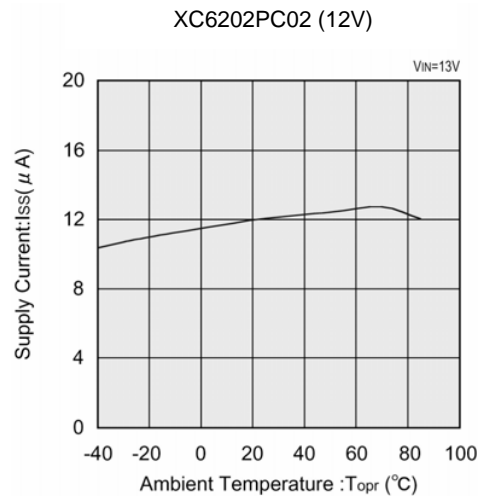

(7) Current Limiter Circuit

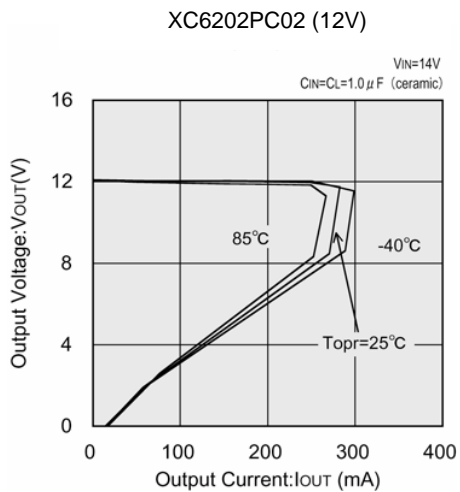

TYPICAL PERFORMANCE CHARACTERISTICS (Continued)

XC6202PC02 (Continued)

(8) Input Transient Response 1

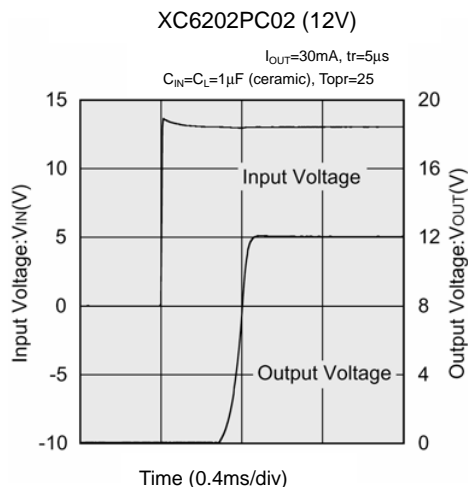
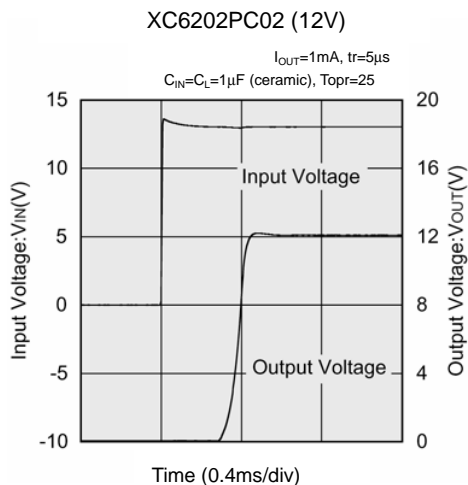

(9) Input Transient Response 2

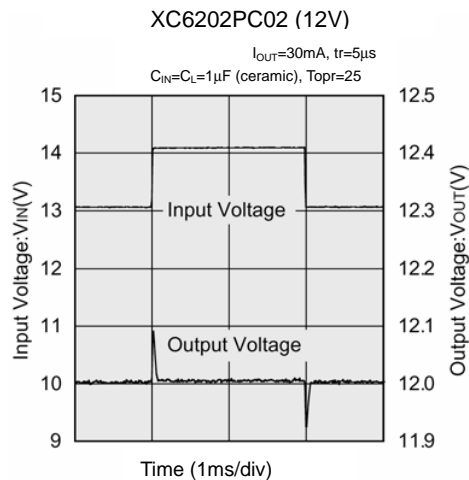
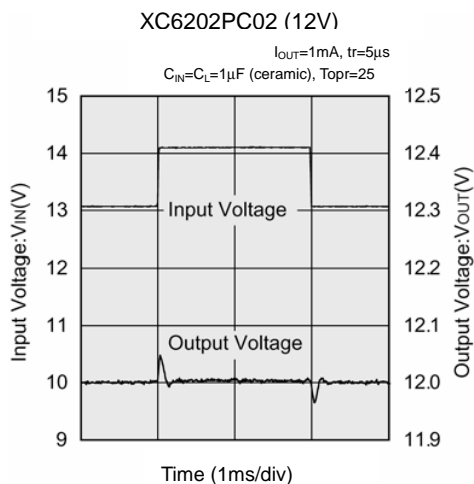

(10) Load Transient Response

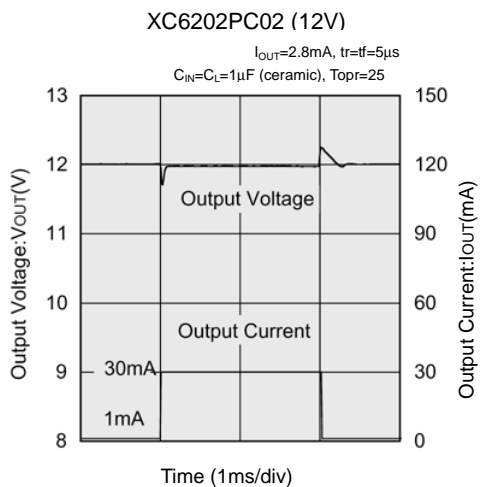

TYPICAL PERFORMANCE CHARACTERISTICS (Continued)

XC6202PC02 (Continued)

(11) Ripple Rejection Rate

XC6202PC02 (12V)

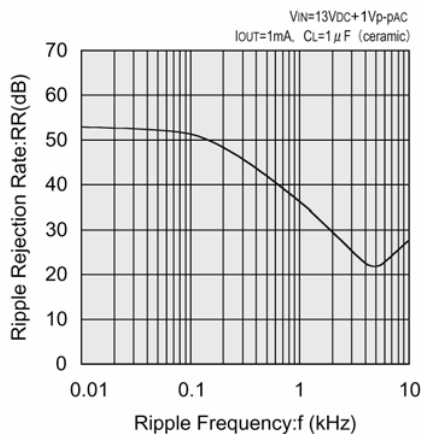

XC6202PC02 (12V)

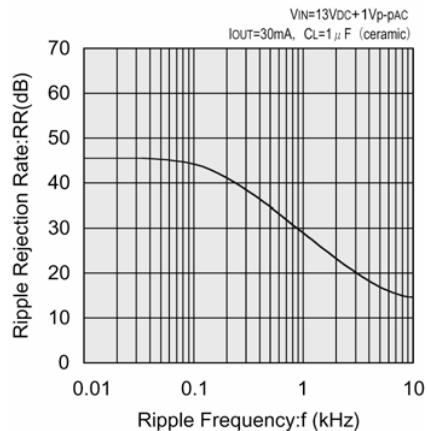

XC6202PC02 (12V)

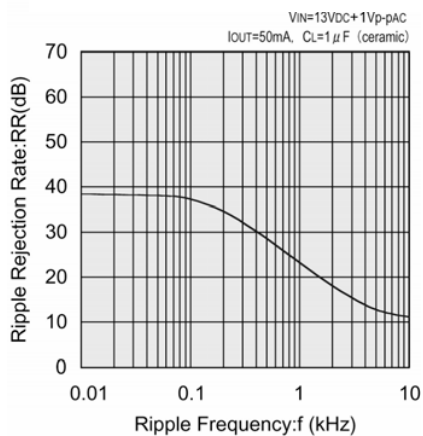

TYPICAL PERFORMANCE CHARACTERISTICS (Continued)

XC6202PJ02

(1) Output Voltage vs. Output Current

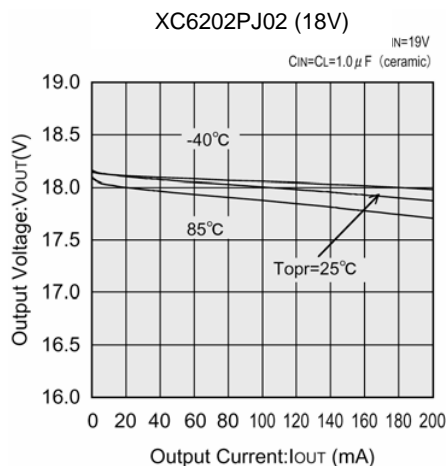

(2) Output Voltage vs. Input Voltage

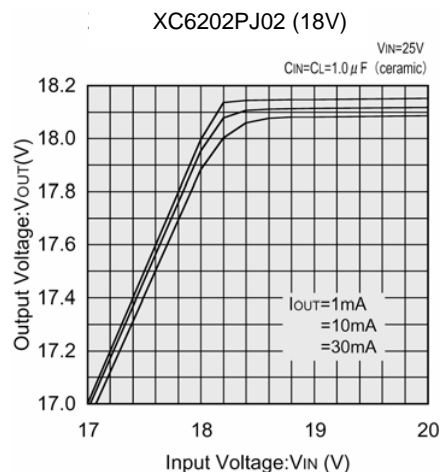

(3) Dropout Voltage vs. Output Current

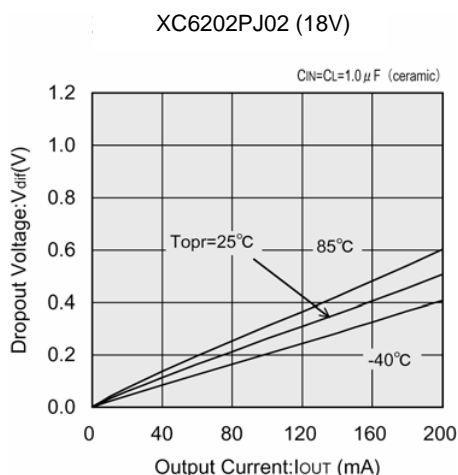

(4) Supply Current vs. Input Voltage

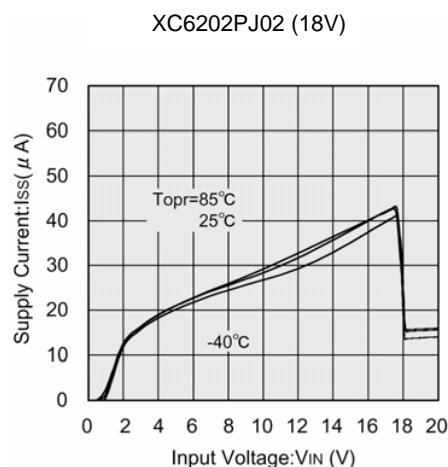

(5) Output Voltage vs. Ambient Temperature

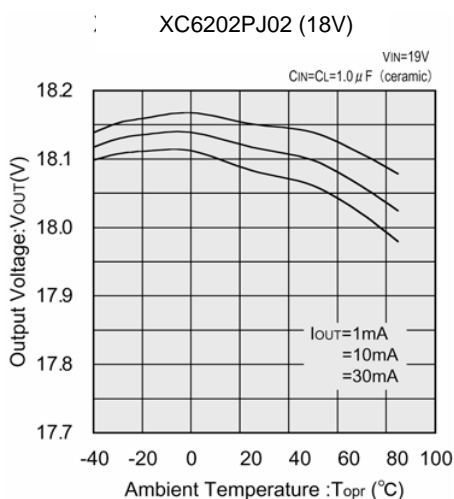

(6) Supply Current vs. Ambient Temperature

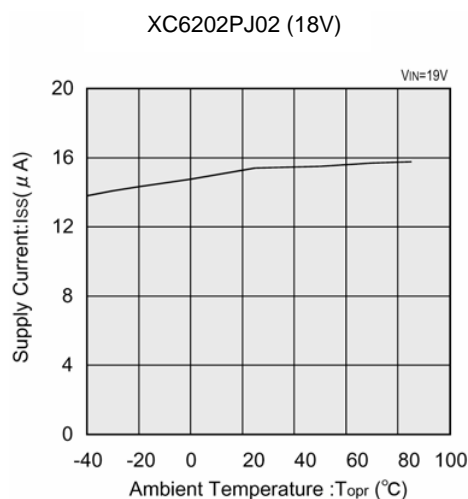

TYPICAL PERFORMANCE CHARACTERISTICS (Continued)

XC6202PJ02 (Continued)

(7) Current Limiter Circuit

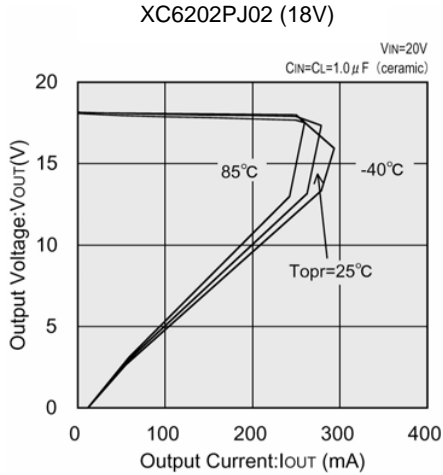

(8) Input Transient Response 1

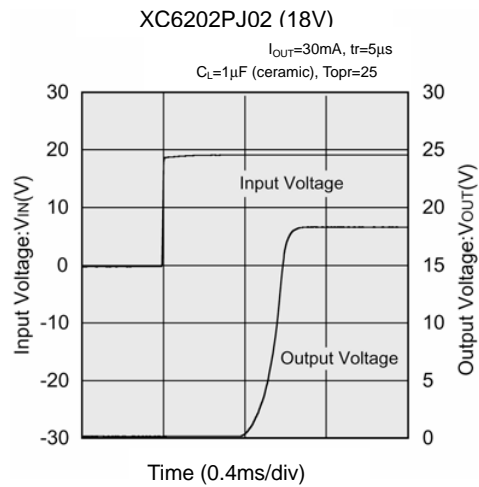
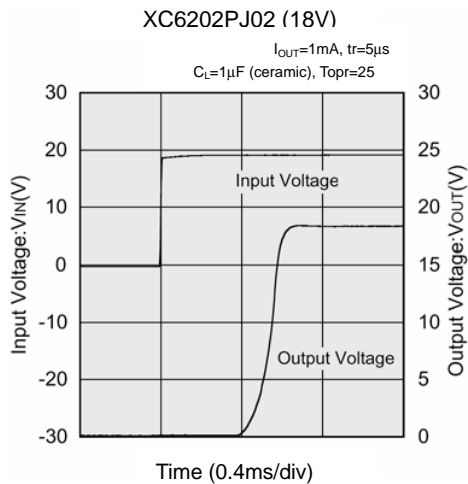

(9) Input Transient Response 2

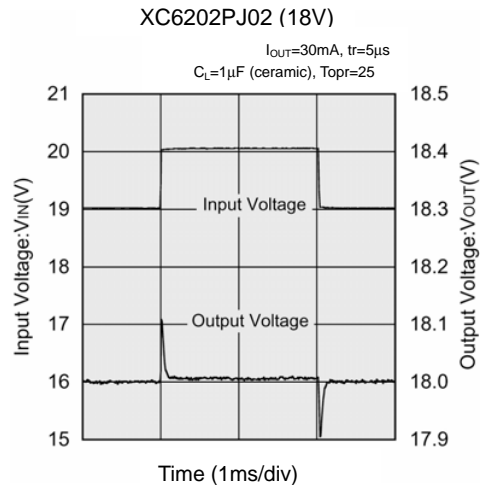
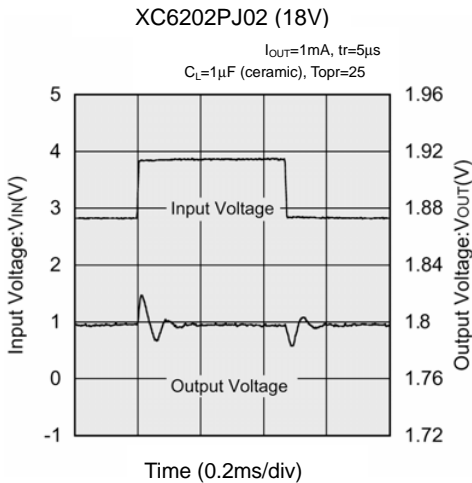

TYPICAL PERFORMANCE CHARACTERISTICS (Continued)

XC6202PJ02 (Continued)

(10) Load Transient Response

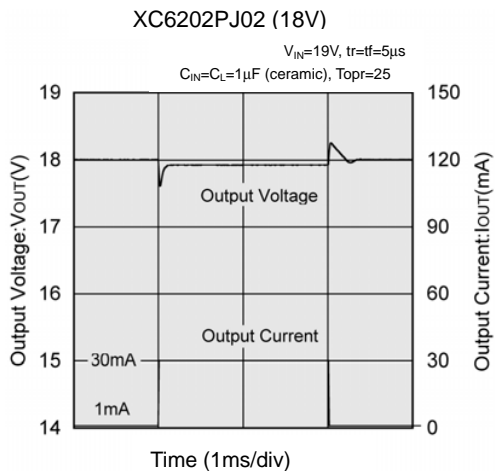

(11) Ripple Rejection Rate

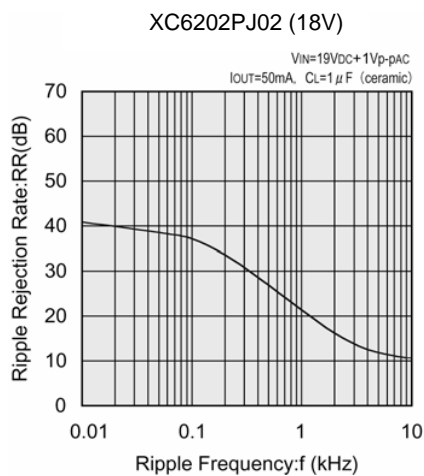
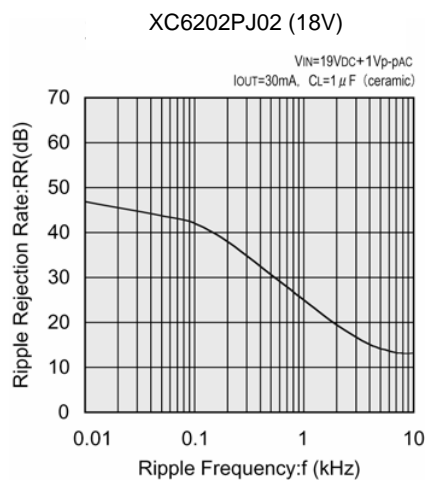
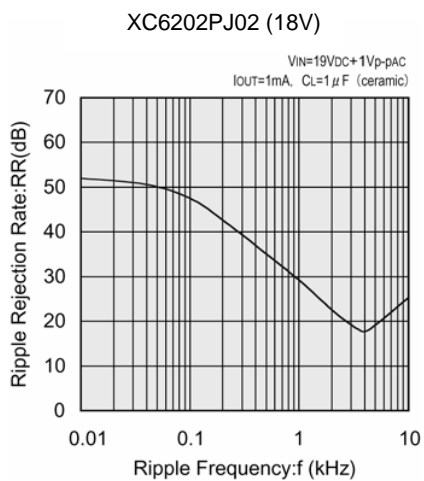

PACKAGING INFORMATION

SOT-23

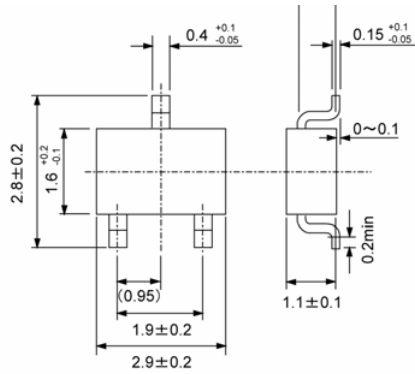

SOT-89

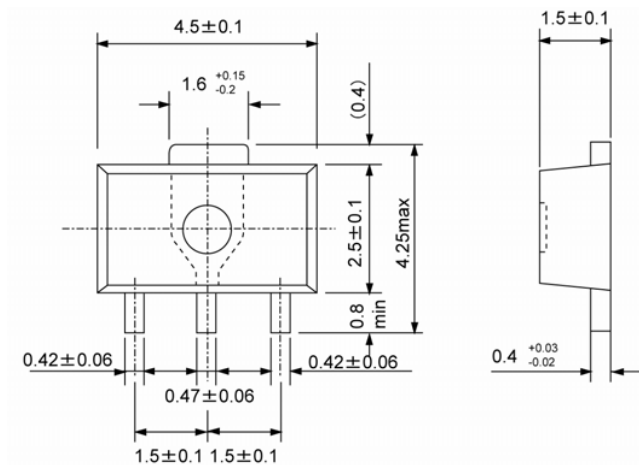

PACKAGING INFORMATION (Continued)

TO-92

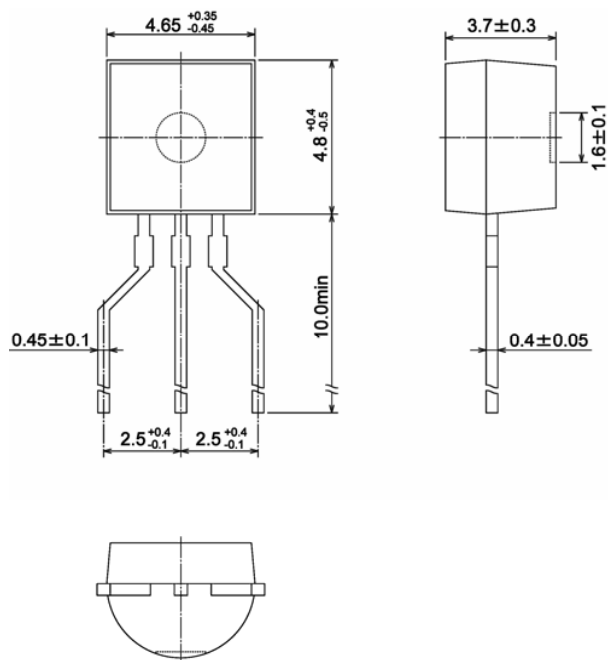

SOT-223

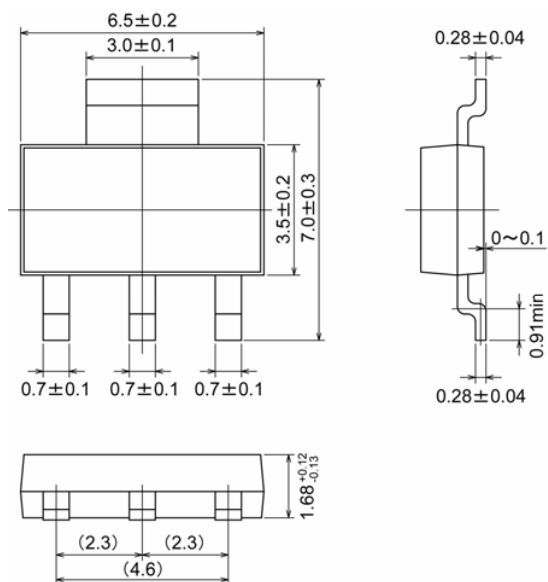

PACKAGING INFORMATION (Continued)

USP-6B

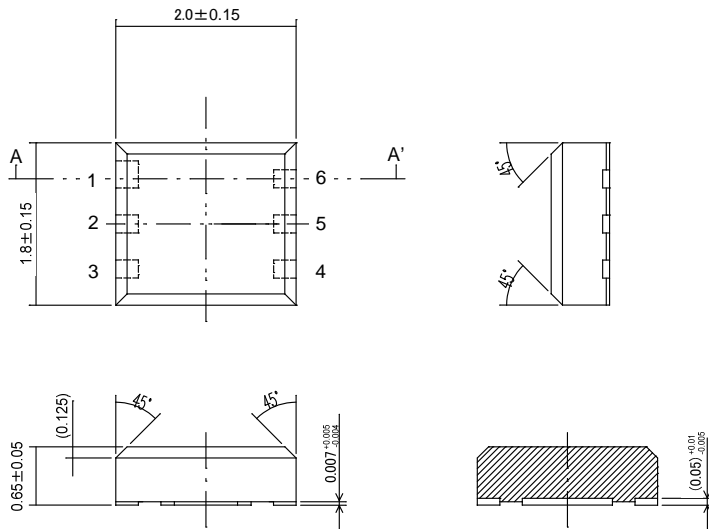

A-A' cross section

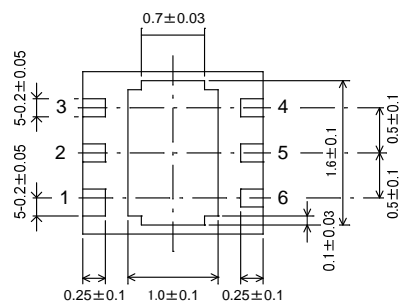

Note: Pin 1 is larger than the other pins

USP-6B Recommended Pattern Layout

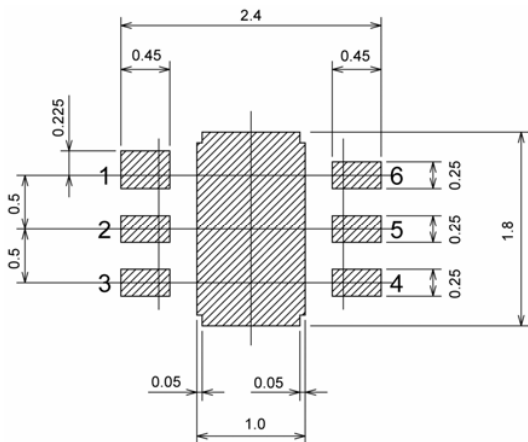

USP-6B Recommended Metal Mask Design

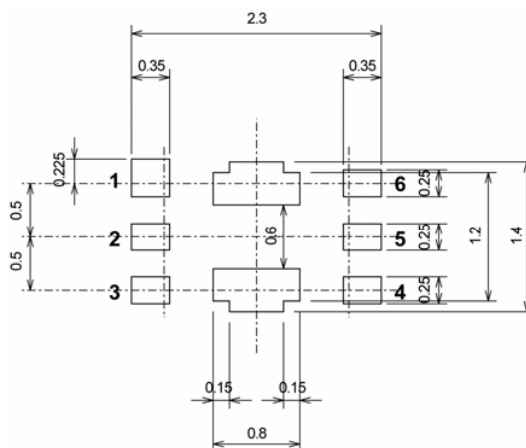

MARKING RULE

SOT-23, SOT-89, SOT-223

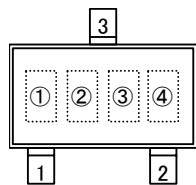

SOT-23
(TOP VIEW)

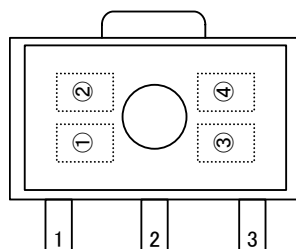

SOT-89
(TOP VIEW)

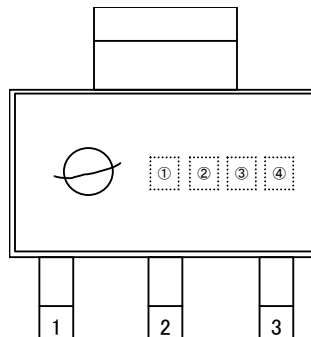

SOT-223
(TOP VIEW)

Represents product series

| MARK | PRODUCT SERIES |
|------|----------------|
| 2 | XC6202Pxxxx |

Represents output voltage range

| MARK | VOLTAGE (V) | PRODUCT SERIES |
|------|-------------|----------------|
| 4 | 0.1 ~ 3.0 | XC6202Pxxxx |
| 5 | 3.1 ~ 6.0 | |
| 6 | 6.1 ~ 9.0 | |
| 7 | 9.1 ~ 12.0 | |
| 8 | 12.1 ~ 15.0 | |
| 9 | 15.1 ~ 18.0 | |

Represents output voltage

| MARK | VOLTAGE (V) | | | | | MARK | VOLTAGE (V) | | | | | | |
|------|-------------|-----|-----|------|------|------|-------------|-----|-----|-----|------|------|------|
| 0 | - | 3.1 | 6.1 | 9.1 | 12.1 | 15.1 | F | - | 4.6 | 7.6 | 10.6 | 13.6 | 16.6 |
| 1 | - | 3.2 | 6.2 | 9.2 | 12.2 | 15.2 | H | - | 4.7 | 7.7 | 10.7 | 13.7 | 16.7 |
| 2 | - | 3.3 | 6.3 | 9.3 | 12.3 | 15.3 | K | 1.8 | 4.8 | 7.8 | 10.8 | 13.8 | 16.8 |
| 3 | - | 3.4 | 6.4 | 9.4 | 12.4 | 15.4 | L | 1.9 | 4.9 | 7.9 | 10.9 | 13.9 | 16.9 |
| 4 | - | 3.5 | 6.5 | 9.5 | 12.5 | 15.5 | M | 2.0 | 5.0 | 8.0 | 11.0 | 14.0 | 17.0 |
| 5 | - | 3.6 | 6.6 | 9.6 | 12.6 | 15.6 | N | 2.1 | 5.1 | 8.1 | 11.1 | 14.1 | 17.1 |
| 6 | - | 3.7 | 6.7 | 9.7 | 12.7 | 15.7 | P | 2.2 | 5.2 | 8.2 | 11.2 | 14.2 | 17.2 |
| 7 | - | 3.8 | 6.8 | 9.8 | 12.8 | 15.8 | R | 2.3 | 5.3 | 8.3 | 11.3 | 14.3 | 17.3 |
| 8 | - | 3.9 | 6.9 | 9.9 | 12.9 | 15.9 | S | 2.4 | 5.4 | 8.4 | 11.4 | 14.4 | 17.4 |
| 9 | - | 4.0 | 7.0 | 10.0 | 13.0 | 16.0 | T | 2.5 | 5.5 | 8.5 | 11.5 | 14.5 | 17.5 |
| A | - | 4.1 | 7.1 | 10.1 | 13.1 | 16.1 | U | 2.6 | 5.6 | 8.6 | 11.6 | 14.6 | 17.6 |
| B | - | 4.2 | 7.2 | 10.2 | 13.2 | 16.2 | V | 2.7 | 5.7 | 8.7 | 11.7 | 14.7 | 17.7 |
| C | - | 4.3 | 7.3 | 10.3 | 13.3 | 16.3 | X | 2.8 | 5.8 | 8.8 | 11.8 | 14.8 | 17.8 |
| D | - | 4.4 | 7.4 | 10.4 | 13.4 | 16.4 | Y | 2.9 | 5.9 | 8.9 | 11.9 | 14.9 | 17.9 |
| E | - | 4.5 | 7.5 | 10.5 | 13.5 | 16.5 | Z | 3.0 | 6.0 | 9.0 | 12.0 | 15.0 | 18.0 |

Represents production lot number

0 to 9, A to Z reversed character 0 to 9, A to Z repeated. (G, I, J, O, Q, W excepted)

MARKING RULE(Continued)

TO-92 (T TYPE)

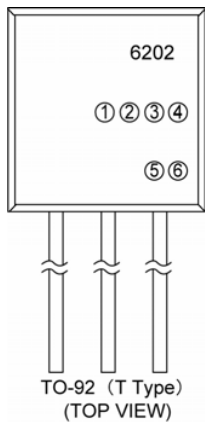

Represents type of regulator

| MARK | PRODUCT SERIES |
|------|----------------|
| P | XC6202Pxxxx |

Represents integer of the output voltage

| MARK | VOLTAGE (V) | PRODUCT SERIES | MARK | VOLTAGE (V) | PRODUCT SERIES |
|------|-------------|----------------|------|-------------|----------------|
| 1 | 1.x | XC6202P1xxxx | A | 10.x | XC6202PAxxxx |
| 2 | 2.x | XC6202P2xxxx | B | 11.x | XC6202PBxxxx |
| 3 | 3.x | XC6202P3xxxx | C | 12.x | XC6202PCxxxx |
| 4 | 4.x | XC6202P4xxxx | D | 13.x | XC6202PDxxxx |
| 5 | 5.x | XC6202P5xxxx | E | 14.x | XC6202PExxxx |
| 6 | 6.x | XC6202P6xxxx | F | 15.x | XC6202PFxxxx |
| 7 | 7.x | XC6202P7xxxx | G | 16.x | XC6202PGxxxx |
| 8 | 8.x | XC6202P8xxxx | H | 17.x | XC6202PHxxxx |
| 9 | 9.x | XC6202P9xxxx | J | 18.x | XC6202PJxxxx |

Represents decimal number of output voltage

| MARK | VOLTAGE (V) | PRODUCT SERIES |
|------|-------------|----------------|
| 3 | x.3 | XC6202Px3xxx |
| 0 | x.0 | XC6202Px0xxx |

Represents detect voltage accuracy

| MARK | DETECT VOLTAGE ACCURACY | PRODUCT SERIES |
|------|-------------------------|----------------|
| 2 | Within $\pm 2\%$ | XC6202Pxx2xx |
| 1 | Within $\pm 1\%$ | XC6202Pxx1xx |

Represents a least significant digit of production year

| MARK | PRODUCTION YEAR |
|------|-----------------|
| 3 | 2003 |
| 4 | 2004 |

Represents production lot number

0 to 9, A to Z repeated (G, I, J, O, Q, W excepted)

Note: No character inversion used.

MARKING RULE (Continued)

USP-6B

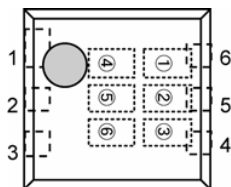

USP-6B
(TOP VIEW)

Represents product series

| MARK | | PRODUCT SERIES |
|------|---|----------------|
| | | |
| 0 | 2 | XC6202PxxxDx |

Represents type of regulator

| MARK | PRODUCT SERIES |
|------|----------------|
| P | XC6202Pxxxx |

Represents integer of the output voltage

| MARK | VOLTAGE (V) | PRODUCT SERIES | MARK | VOLTAGE (V) | PRODUCT SERIES |
|------|-------------|----------------|------|-------------|----------------|
| 1 | 1.x | XC6202P1xxDx | A | 10.x | XC6202PAxxDx |
| 2 | 2.x | XC6202P2xxDx | B | 11.x | XC6202PBxxDx |
| 3 | 3.x | XC6202P3xxDx | C | 12.x | XC6202PCxxDx |
| 4 | 4.x | XC6202P4xxDx | D | 13.x | XC6202PDxxDx |
| 5 | 5.x | XC6202P5xxDx | E | 14.x | XC6202PExxDx |
| 6 | 6.x | XC6202P6xxDx | F | 15.x | XC6202PFxxDx |
| 7 | 7.x | XC6202P7xxDx | G | 16.x | XC6202PGxxDx |
| 8 | 8.x | XC6202P8xxDx | H | 17.x | XC6202PHxxDx |
| 9 | 9.x | XC6202P9xxDx | J | 18.x | XC6202PJxxDx |

Represents decimal number of output voltage

| MARK | VOLTAGE (V) | PRODUCT SERIES |
|------|-------------|----------------|
| 3 | X.3 | XC6202Px3xDx |
| 0 | X.0 | XC6202Px0xDx |

Represents production lot number

0 to 9, A to Z repeated (G, I, J, O, Q, W excepted)

Note: No character inversion used.

1. The products and product specifications contained herein are subject to change without notice to improve performance characteristics. Consult us, or our representatives before use, to confirm that the information in this catalog is up to date.
2. We assume no responsibility for any infringement of patents, patent rights, or other rights arising from the use of any information and circuitry in this catalog.
3. Please ensure suitable shipping controls (including fail-safe designs and aging protection) are in force for equipment employing products listed in this catalog.
4. The products in this catalog are not developed, designed, or approved for use with such equipment whose failure or malfunction can be reasonably expected to directly endanger the life of, or cause significant injury to, the user.
(e.g. Atomic energy; aerospace; transport; combustion and associated safety equipment thereof.)
5. Please use the products listed in this catalog within the specified ranges.
Should you wish to use the products under conditions exceeding the specifications, please consult us or our representatives.
6. We assume no responsibility for damage or loss due to abnormal use.
7. All rights reserved. No part of this catalog may be copied or reproduced without the prior permission of Torex Semiconductor Ltd.

TOREX SEMICONDUCTOR LTD.