

# LM4881 Boomer® Audio Power Amplifier Series

## Dual 200 mW Headphone Amplifier with Shutdown Mode

### General Description

The LM4881 is a dual audio power amplifier capable of delivering 200mW of continuous average power into an 8Ω load with 0.1% THD+N from a 5V power supply.

Boomer audio power amplifiers were designed specifically to provide high quality output power with a minimal amount of external components using surface mount packaging. Since the LM4881 does not require bootstrap capacitors or snubber networks, it is optimally suited for low-power portable systems.

The LM4881 features an externally controlled, low power consumption shutdown mode which is virtually clickless and popless, as well as an internal thermal shutdown protection mechanism.

The unity-gain stable LM4881 can be configured by external gain-setting resistors.

- THD+N at 1kHz at 75mW continuous average output power into 32Ω 0.02% (typ)
- Output power at 10% THD+N at 1kHz into 8Ω 300mW (typ)
- Shutdown Current 0.7μA (typ)
- Supply voltage range 2.7V to 5.5V

### Features

- MSOP surface mount packaging
- Unity-gain stable
- External gain configuration capability
- Thermal shutdown protection circuitry
- No bootstrap capacitors, or snubber circuits are necessary

### Key Specifications

- THD+N at 1kHz at 125mW continuous average output power into 8Ω 0.1% (max)

### Applications

- Headphone Amplifier
- Personal Computers
- Microphone Preamplifier

### Typical Application

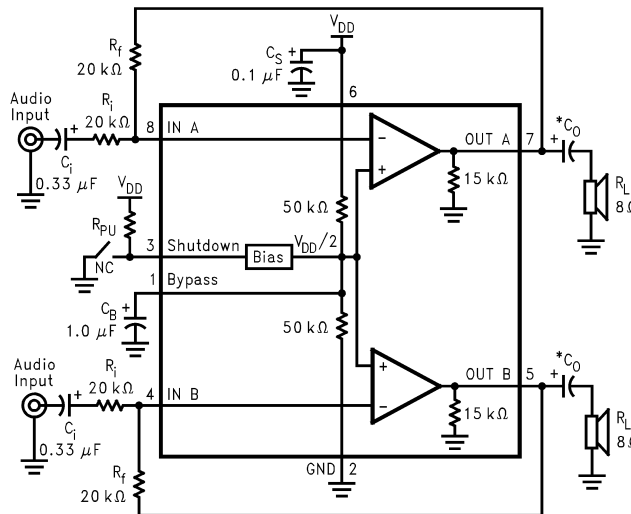

10000501

\*Refer to the **Application Information** Section for information concerning proper selection of the input and output coupling capacitors.

**FIGURE 1. Typical Audio Amplifier Application Circuit**

## Connection Diagrams

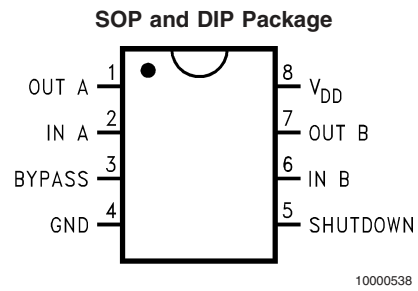
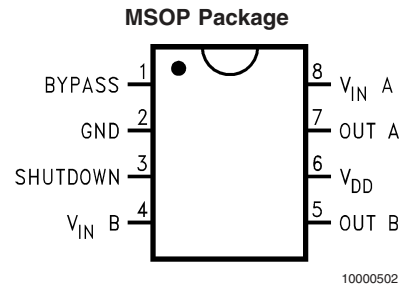

### Top View

Order Number LM4881MM, LM4881M, or LM4881N  
See NS Package Number MUA08A, M08A, or N08E

**Absolute Maximum Ratings** (Note 3)

If Military/Aerospace specified devices are required, please contact the National Semiconductor Sales Office/Distributors for availability and specifications.

Supply Voltage	6.0V
Storage Temperature	-65°C to +150°C
Input Voltage	-0.3V to $V_{DD} + 0.3V$
Power Dissipation (Note 4)	Internally limited
ESD Susceptibility (Note 5)	2000V
ESD Susceptibility (Note 6)	200V
Junction Temperature	150°C
Soldering Information (Note 1)	
Small Outline Package	
Vapor Phase (60 seconds)	215°C
Infrared (15 seconds)	220°C

## Thermal Resistance

$\theta_{JC}$ (MSOP)	56°C/W
$\theta_{JA}$ (MSOP)	210°C/W
$\theta_{JC}$ (SOP)	35°C/W
$\theta_{JA}$ (SOP)	170°C/W
$\theta_{JC}$ (DIP)	37°C/W
$\theta_{JA}$ (DIP)	107°C/W

**Operating Ratings**

## Temperature Range

$$T_{MIN} \leq T_A \leq T_{MAX} \quad -40^\circ\text{C} \leq T_A \leq 85^\circ\text{C}$$

## Supply Voltage

$$2.7V \leq V_{DD} \leq 5.5V$$

**Note 1:** See AN-450 "Surface Mounting and their Effects on Product Reliability" for other methods of soldering surface mount devices.

**Electrical Characteristics** (Notes 2, 3)

The following specifications apply for  $V_{DD} = 5V$  unless otherwise specified. Limits apply for  $T_A = 25^\circ\text{C}$ .

Symbol	Parameter	Conditions	LM4881		Units (Limits)
			Typ (Note 7)	Limit (Note 8)	
$V_{DD}$	Power Supply Voltage			2.7 5.5	V (min) V (max)
$I_{DD}$	Quiescent Current	$V_{IN} = 0V, I_O = 0A$	3.6	6.0	mA (max)
$I_{SD}$	Shutdown Current	$V_{PIN1} = V_{DD}$	0.7	5	$\mu\text{A}$ (max)
$V_{OS}$	Offset Voltage	$V_{IN} = 0V$	5	50	mV (max)
$P_O$	Output Power	THD = 0.1% (max); f = 1 kHz; $R_L = 8\Omega$ $R_L = 16\Omega$ $R_L = 32\Omega$ THD + N = 10%; f = 1 kHz; $R_L = 8\Omega$ $R_L = 16\Omega$ $R_L = 32\Omega$	200 150 85	125	mW (min) mW mW
THD+N	Total Harmonic Distortion + Noise	$R_L = 16\Omega, P_O = 120 \text{ mWrms};$ $R_L = 32\Omega, P_O = 75 \text{ mWrms};$ f = 1 kHz	0.025 0.02		% %
PSRR		$C_B = 1.0 \mu\text{F}, V_{RIPPLE} = 200 \text{ mVrms}, f = 120\text{Hz}$	50		dB

## Electrical Characteristics (Notes 2, 3)

The following specifications apply for  $V_{DD} = 3V$  unless otherwise specified. Limits apply for  $T_A = 25^\circ C$ .

Symbol	Parameter	Conditions	LM4881		Units (Limits)
			Typ (Note 7)	Limit (Note 8)	
$I_{DD}$	Quiescent Current	$V_{IN} = 0V, I_O = 0A$	1.1		mA
$I_{SD}$	Shutdown Current	$V_{PIN1} = V_{DD}$	0.7		$\mu A$
$V_{OS}$	Offset Voltage	$V_{IN} = 0V$	5		mV
$P_O$	Output Power	THD = 1% (max); f = 1 kHz; $R_L = 8\Omega$	70		mW
		$R_L = 16\Omega$	65		mW
		$R_L = 32\Omega$	30		mW
		THD + N = 10%; f = 1 kHz; $R_L = 8\Omega$	95		mW
		$R_L = 16\Omega$	65		mW
		$R_L = 32\Omega$	35		mW
THD+N	Total Harmonic Distortion + Noise	$R_L = 16\Omega, P_O = 60 \text{ mWrms};$	0.2		%
		$R_L = 32\Omega, P_O = 25 \text{ mWrms}; f = 1 \text{ kHz}$	0.03		%
PSRR	Power Supply Rejection Ratio	$C_B = 1.0 \mu F, V_{RIPPLE} = 200 \text{ mVrms}, f = 100 \text{ Hz}$	50		dB

**Note 2:** All voltages are measured with respect to the ground pin, unless otherwise specified.

**Note 3:** *Absolute Maximum Ratings* indicate limits beyond which damage to the device may occur. *Operating Ratings* indicate conditions for which the device is functional, but do not guarantee specific performance limits. *Electrical Characteristics* state DC and AC electrical specifications under particular test conditions which guarantee specific performance limits. This assumes that the device is within the Operating Ratings. Specifications are not guaranteed for parameters where no limit is given, however, the typical value is a good indication of device performance.

**Note 4:** The maximum power dissipation must be derated at elevated temperatures and is dictated by  $T_{JMAX}$ ,  $\theta_{JA}$ , and the ambient temperature  $T_A$ . The maximum allowable power dissipation is  $P_{DMAX} = (T_{JMAX} - T_A) / \theta_{JA}$ . For the LM4881,  $T_{JMAX} = 150^\circ C$ , and the typical junction-to-ambient thermal resistance, when board mounted, is  $210^\circ C/W$  for the MSOP Package and  $107^\circ C/W$  for package N08E.

**Note 5:** Human body model, 100 pF discharged through a 1.5 k $\Omega$  resistor.

**Note 6:** Machine Model, 220 pF–240 pF discharged through all pins.

**Note 7:** Typical values are measured at  $25^\circ C$  and represent the parametric norm.

**Note 8:** Limits are guaranteed to National's AOQL (Average Outgoing Quality Level).

## External Components Description

(Figure 1)

Components	Functional Description
1. $R_i$	Inverting input resistance which sets the closed-loop gain in conjunction with $R_f$ . This resistor also forms a high pass filter with $C_i$ at $f_c = 1 / (2\pi R_i C_i)$ .
2. $C_i$	Input coupling capacitor which blocks the DC voltage at the amplifier's input terminals. Also creates a highpass filter with $R_i$ at $f_c = 1 / (2\pi R_i C_i)$ . Refer to the section, <b>Proper Selection of External Components</b> , for an explanation of how to determine the value of $C_i$ .
3. $R_f$	Feedback resistance which sets closed-loop gain in conjunction with $R_i$ .
4. $C_S$	Supply bypass capacitor which provides power supply filtering. Refer to the <b>Application Information</b> section for proper placement and selection of the supply bypass capacitor.
5. $C_B$	Bypass pin capacitor which provides half-supply filtering. Refer to the section, <b>Proper Selection of External Components</b> , for information concerning proper placement and selection of $C_B$ .
6. $C_O$	Output coupling capacitor which blocks the DC voltage at the amplifier's output. Forms a high pass filter with $R_L$ at $f_o = 1/(2\pi R_L C_O)$

## Typical Performance Characteristics

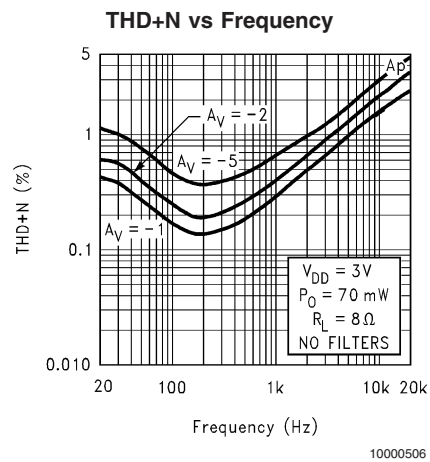
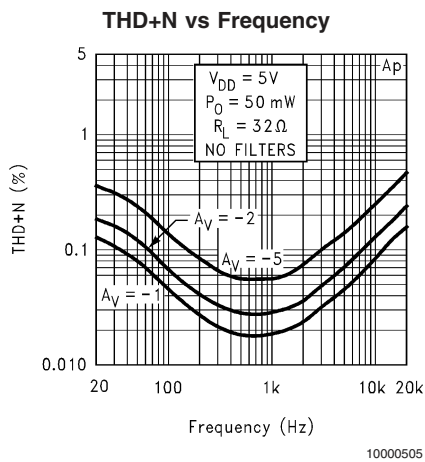
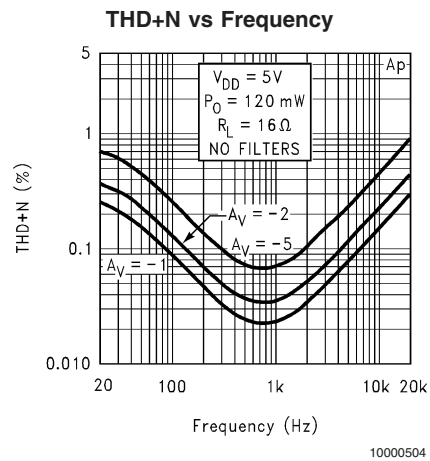
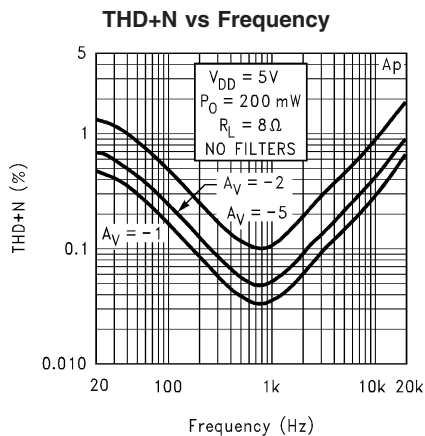

Typical Performance Characteristics (Continued)

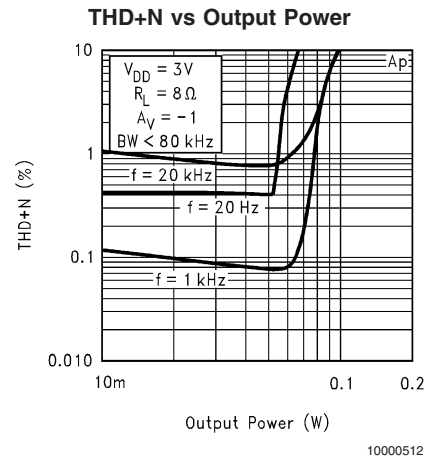
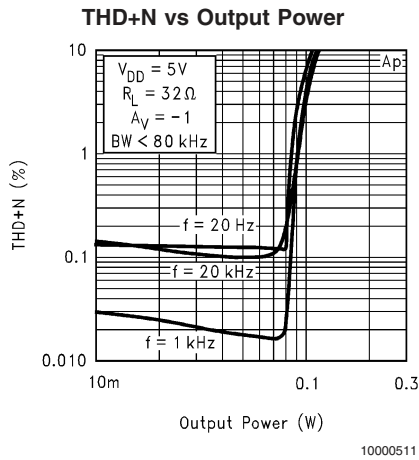
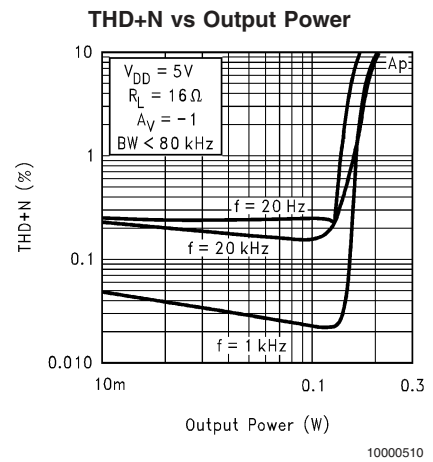
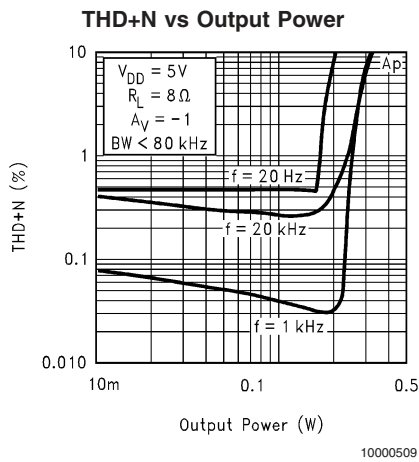
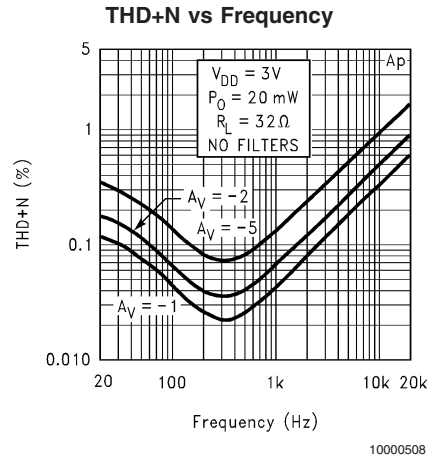
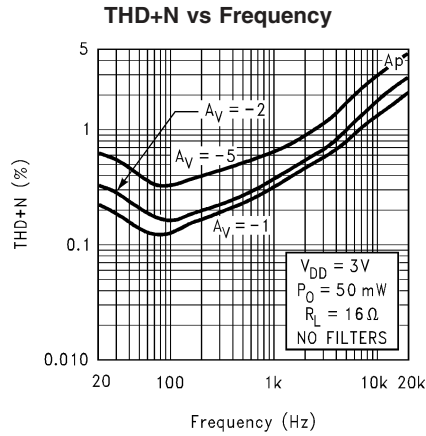

Typical Performance Characteristics (Continued)

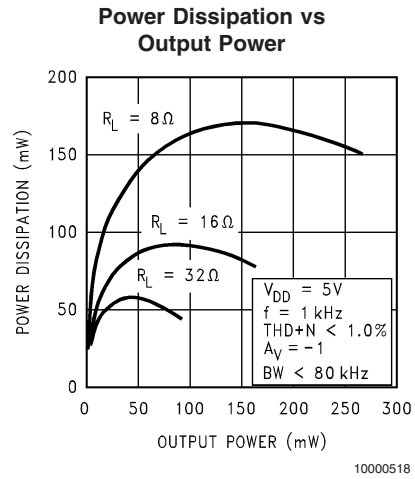
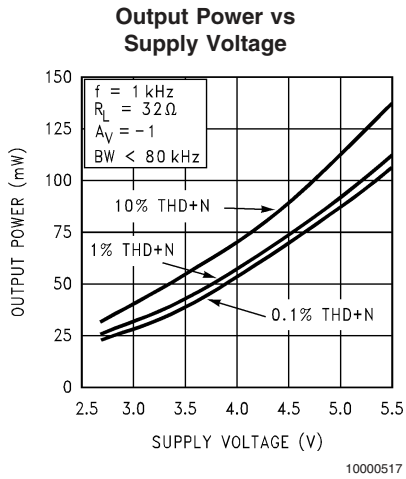
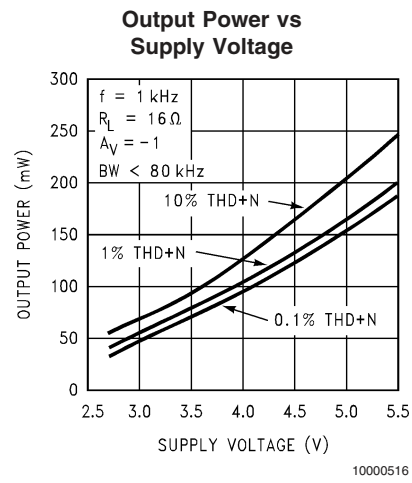
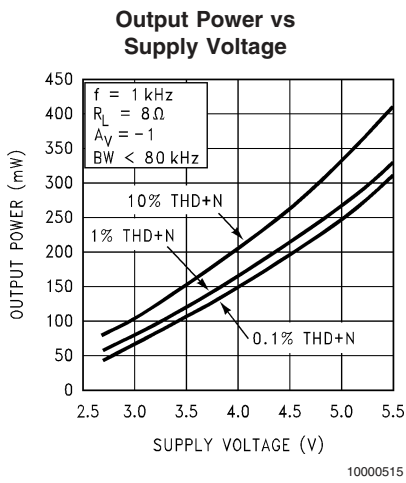
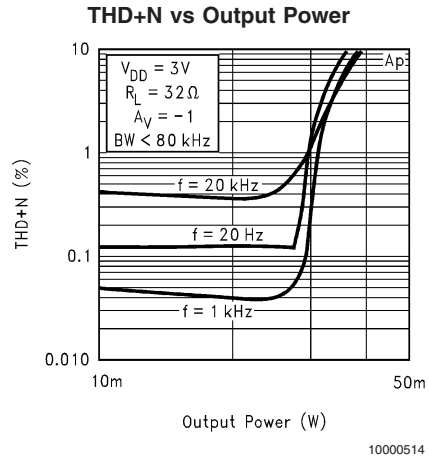
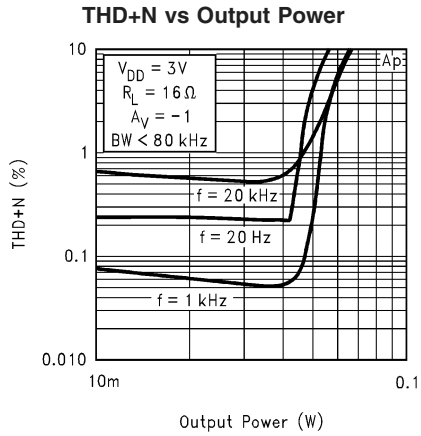

# Typical Performance Characteristics (Continued)

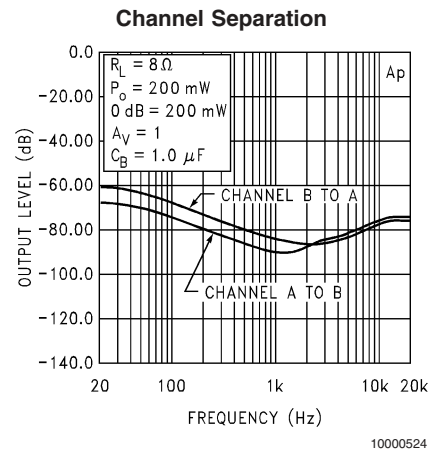
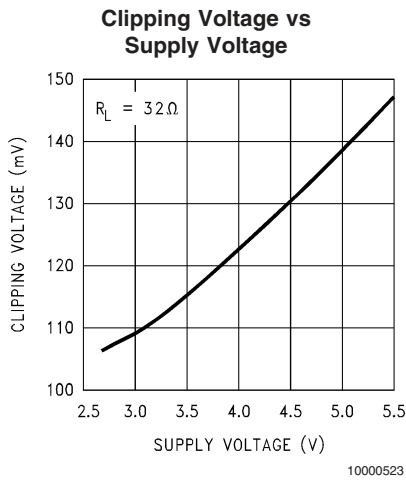
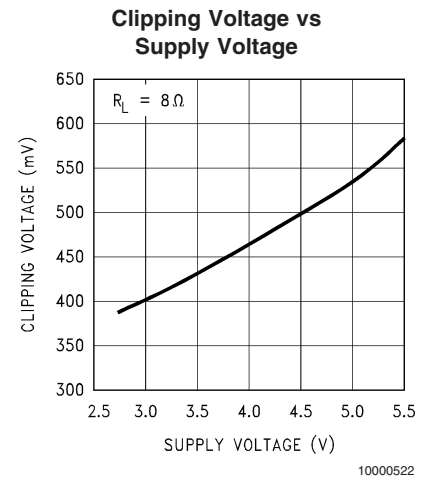
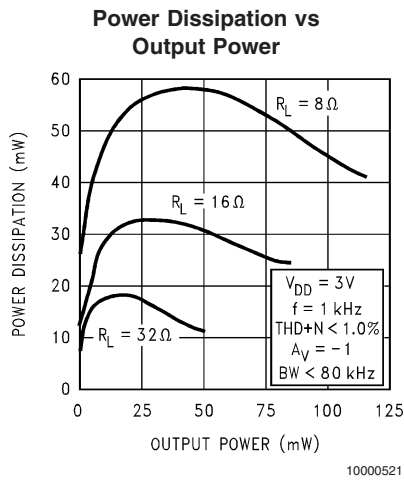
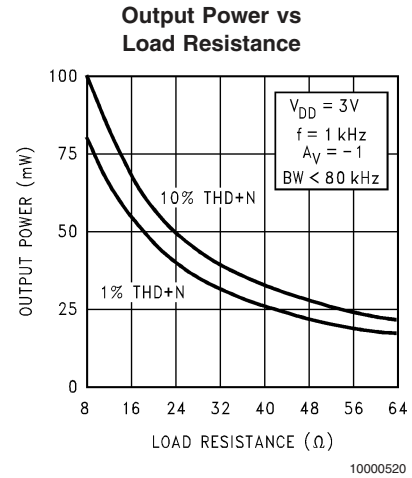
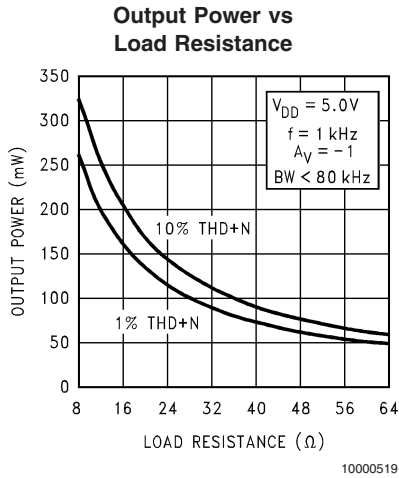



Typical Performance Characteristics (Continued)

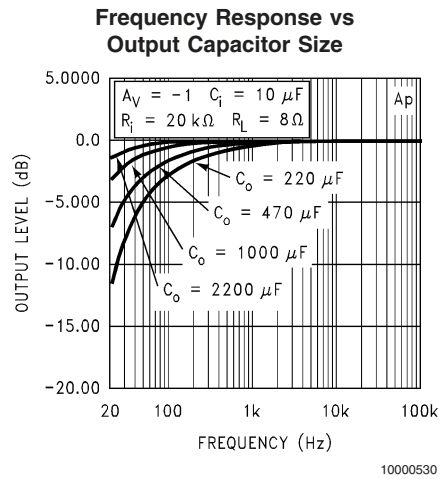
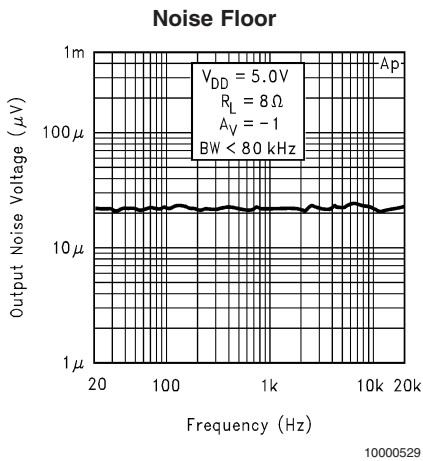
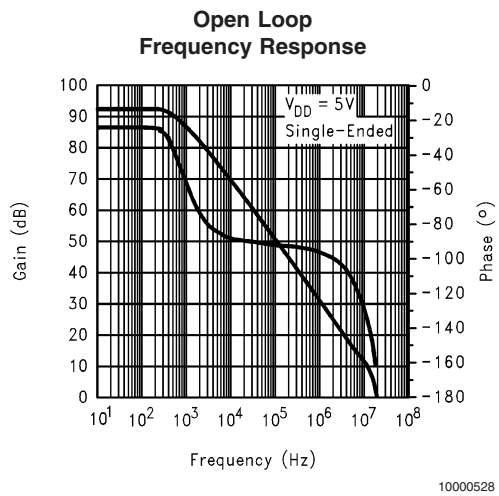
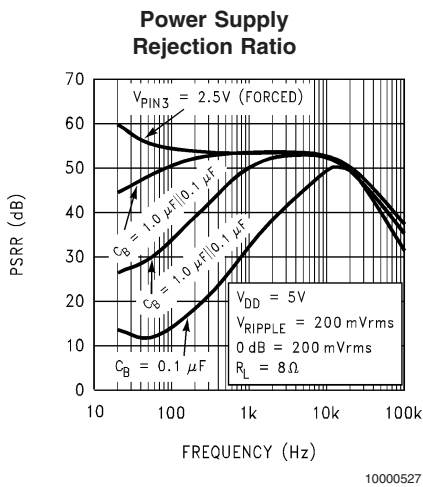
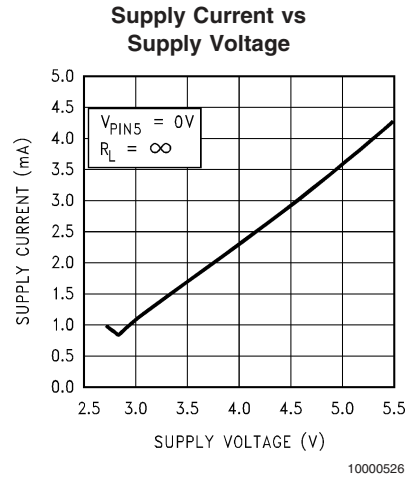
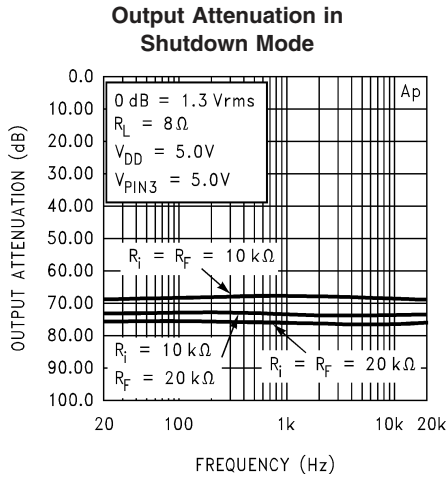

# Typical Performance Characteristics (Continued)

**Frequency Response vs Output Capacitor Size**

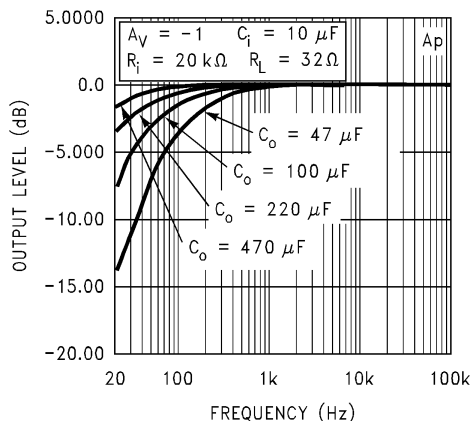

**Frequency Response vs Output Capacitor Size**

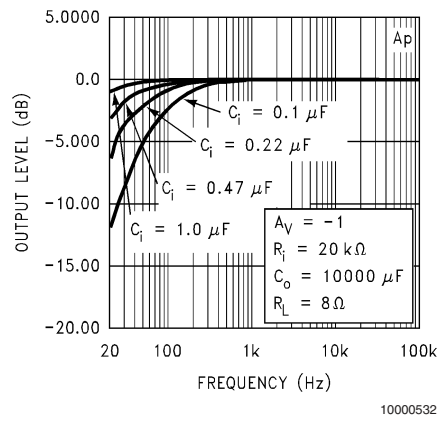

**Typical Application Frequency Response**

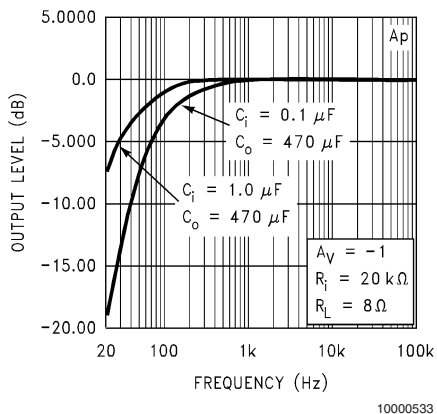

**Typical Application Frequency Response**

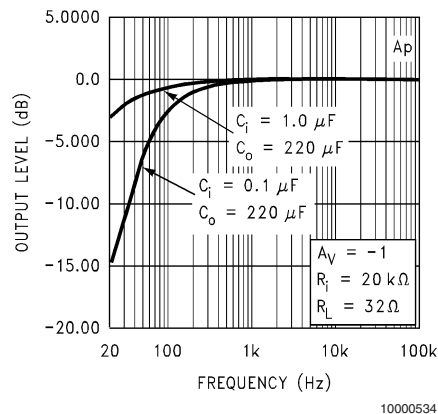

**Power Derating Curve**

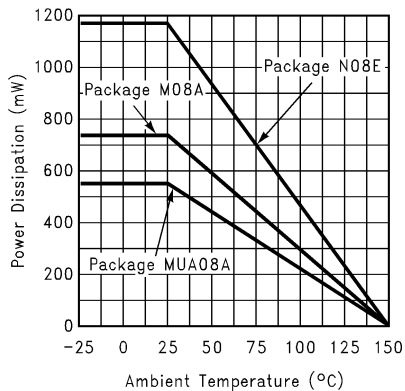

## Application Information

### SHUTDOWN FUNCTION

In order to reduce power consumption while not in use, the LM4881 contains a shutdown pin to externally turn off the amplifier's bias circuitry. This shutdown feature turns the amplifier off when a logic high is placed on the shutdown pin. The trigger point between a logic low and logic high level is typically half supply. It is best to switch between ground and supply to provide maximum device performance. By switching the shutdown pin to the  $V_{DD}$ , the LM4881 supply current draw will be minimized in idle mode. While the device will be disabled with shutdown pin voltages less than  $V_{DD}$ , the idle current may be greater than the typical value of 0.7  $\mu\text{A}$ . In either case, the shutdown pin should be tied to a definite voltage because leaving the pin floating may result in an unwanted shutdown condition. In many applications, a microcontroller or microprocessor output is used to control the shutdown circuitry which provides a quick, smooth transition into shutdown. Another solution is to use a single-pole, single-throw switch in conjunction with an external pull-up resistor. When the switch is closed, the shutdown pin is connected to ground and enables the amplifier. If the switch is open, then the external pull-up resistor will disable the LM4881. This scheme guarantees that the shutdown pin will not float which will prevent unwanted state changes.

### POWER DISSIPATION

Power dissipation is a major concern when using any power amplifier and must be thoroughly understood to ensure a successful design. Equation 1 states the maximum power dissipation point for a single-ended amplifier operating at a given supply voltage and driving a specified output load.

$$P_{DMAX} = (V_{DD})^2 / (2\pi^2 R_L) \quad (1)$$

Since the LM4881 has two operational amplifiers in one package, the maximum internal power dissipation point is twice that of the number which results from Equation 1. Even with the large internal power dissipation, the LM4881 does not require heat sinking over a large range of ambient temperature. From Equation 1, assuming a 5V power supply and an 8 $\Omega$  load, the maximum power dissipation point is 158 mW per amplifier. Thus the maximum package dissipation point is 317 mW. The maximum power dissipation point obtained must not be greater than the power dissipation that results from Equation 2:

$$P_{DMAX} = (T_{JMAX} - T_A) / \theta_{JA} \quad (2)$$

For package MUA08A,  $\theta_{JA} = 230^\circ\text{C}/\text{W}$ , and for package M08A,  $\theta_{JA} = 170^\circ\text{C}/\text{W}$ , and for package N08E,  $\theta_{JA} = 107^\circ\text{C}/\text{W}$ .  $T_{JMAX} = 150^\circ\text{C}$  for the LM4881. Depending on the ambient temperature,  $T_A$ , of the system surroundings, Equation 2 can be used to find the maximum internal power dissipation supported by the IC packaging. If the result of Equation 1 is greater than that of Equation 2, then either the supply voltage must be decreased, the load impedance increased or  $T_A$  reduced. For the typical application of a 5V power supply, with an 8 $\Omega$  load, the maximum ambient temperature possible without violating the maximum junction temperature is approximately 96 $^\circ\text{C}$  provided that device operation is around the maximum power dissipation point. Power dissipation is a function of output power and thus, if typical operation is not around the maximum power dissipation point, the ambient temperature may be increased accordingly. Refer to the **Typical Performance Characteristics** curves for power dissipation information for lower output powers.

### POWER SUPPLY BYPASSING

As with any power amplifier, proper supply bypassing is critical for low noise performance and high power supply rejection. The capacitor location on both the bypass and power supply pins should be as close to the device as possible. As displayed in the **Typical Performance Characteristics** section, the effect of a larger half supply bypass capacitor is improved low frequency PSRR due to increased half-supply stability. Typical applications employ a 5V regulator with 10  $\mu\text{F}$  and a 0.1  $\mu\text{F}$  bypass capacitors which aid in supply stability, but do not eliminate the need for bypassing the supply nodes of the LM4881. The selection of bypass capacitors, especially  $C_B$ , is thus dependent upon desired low frequency PSRR, click and pop performance as explained in the section, **Proper Selection of External Components** section, system cost, and size constraints.

### PROPER SELECTION OF EXTERNAL COMPONENTS

Selection of external components when using integrated power amplifiers is critical to optimize device and system performance. While the LM4881 is tolerant of external component combinations, consideration to component values must be used to maximize overall system quality.

The LM4881 is unity gain stable and this gives a designer maximum system flexibility. The LM4881 should be used in low gain configurations to minimize THD+N values, and maximum the signal-to-noise ratio. Low gain configurations require large input signals to obtain a given output power. Input signals equal to or greater than 1  $V_{rms}$  are available from sources such as audio codecs. Please refer to the section, **Audio Power Amplifier Design**, for a more complete explanation of proper gain selection.

Besides gain, one of the major considerations is the closed loop bandwidth of the amplifier. To a large extent, the bandwidth is dictated by the choice of external components shown in *Figure 1*. Both the input coupling capacitor,  $C_i$ , and the output coupling capacitor,  $C_o$ , form first order high pass filters which limit low frequency response. These values should be chosen based on needed frequency response for a few distinct reasons.

### Selection of Input and Output Capacitor Size

Large input and output capacitors are both expensive and space hungry for portable designs. Clearly a certain sized capacitor is needed to couple in low frequencies without severe attenuation. But in many cases the speakers used in portable systems, whether internal or external, have little ability to reproduce signals below 150 Hz. Thus using large input and output capacitors may not increase system performance.

In addition to system cost and size, click and pop performance is effected by the size of the input coupling capacitor,  $C_i$ . A larger input coupling capacitor requires more charge to reach its quiescent DC voltage (nominally 1/2  $V_{DD}$ ). This charge comes from the output via the feedback and is apt to create pops upon device enable. Thus, by minimizing the capacitor size based on necessary low frequency response, turn on pops can be minimized.

Besides minimizing the input and output capacitor sizes, careful consideration should be paid to the bypass capacitor value. Bypass capacitor  $C_B$  is the most critical component to minimize turn on pops since it determines how fast the LM4881 turns on. The slower the LM4881's outputs ramp to their quiescent DC voltage (nominally 1/2  $V_{DD}$ ), the smaller the turn on pop. Thus choosing  $C_B$  equal to 1.0  $\mu\text{F}$  along with a small value of  $C_i$  (in the range of 0.1  $\mu\text{F}$  to 0.39  $\mu\text{F}$ ), the

## Application Information (Continued)

shutdown function should be virtually clickless and popless. While the device will function properly, (no oscillations or motorboating), with  $C_B$  equal to  $0.1 \mu\text{F}$ , the device will be much more susceptible to turn on clicks and pops. Thus, a value of  $C_B$  equal to  $0.1 \mu\text{F}$  or larger is recommended in all but the most cost sensitive designs.

### AUDIO POWER AMPLIFIER DESIGN

#### Design a Dual 200mW/8Ω Audio Amplifier

Given:

Power Output	200 mWrms
Load Impedance	8Ω
Input Level	1 Vrms (max)
Input Impedance	20 kΩ
Bandwidth	100 Hz–20 kHz ± 0.50 dB

A designer must first determine the needed supply rail to obtain the specified output power. Calculating the required supply rail involves knowing two parameters,  $V_{\text{OPEAK}}$  and also the dropout voltage. The latter is typically 530 mV and can be found from the graphs in the **Typical Performance Characteristics**.  $V_{\text{OPEAK}}$  can be determined from Equation 3.

$$V_{\text{opeak}} = \sqrt{(2R_L P_O)} \quad (3)$$

For 200 mW of output power into an 8Ω load, the required  $V_{\text{OPEAK}}$  is 1.79 volts. A minimum supply rail of 2.32V results from adding  $V_{\text{OPEAK}}$  and  $V_{\text{OD}}$ . Since 5V is a standard supply voltage in most applications, it is chosen for the supply rail. Extra supply voltage creates headroom that allows the LM4881 to reproduce peaks in excess of 200 mW without clipping the signal. At this time, the designer must make sure that the power supply choice along with the output impedance does not violate the conditions explained in the **Power**

**Dissipation** section. Remember that the maximum power dissipation point from Equation 1 must be multiplied by two since there are two independent amplifiers inside the package.

Once the power dissipation equations have been addressed, the required gain can be determined from Equation 4.

$$A_V \geq \sqrt{(P_O R_L)} / (V_{IN}) = V_{\text{orms}} / V_{\text{inrms}} \quad (4)$$

$$A_V = R_f / R_i \quad (5)$$

From Equation 4, the minimum gain is:  $A_V = 1.26$

Since the desired input impedance was 20 kΩ, and with a gain of 1.26, a value of 27 kΩ is designated for  $R_f$ , assuming 5% tolerance resistors. This combination results in a nominal gain of 1.35. The final design step is to address the bandwidth requirements which must be stated as a pair of –3 dB frequency points. Five times away from a –3 dB point is 0.17 dB down from passband response assuming a single pole roll-off. As stated in the **External Components** section, both  $R_i$  in conjunction with  $C_i$ , and  $C_o$  with  $R_L$ , create first order highpass filters. Thus to obtain the desired frequency low response of 100 Hz within ±0.5 dB, both poles must be taken into consideration. The combination of two single order filters at the same frequency forms a second order response. This results in a signal which is down 0.34 dB at five times away from the single order filter –3 dB point. Thus, a frequency of 20 Hz is used in the following equations to ensure that the response is better than 0.5 dB down at 100 Hz.

$$C_i \geq 1 / (2\pi * 20 \text{ k}\Omega * 20 \text{ Hz}) = 0.397 \mu\text{F}; \text{ use } 0.39 \mu\text{F}.$$

$$C_o \geq 1 / (2\pi * 8\Omega * 20 \text{ Hz}) = 995 \mu\text{F}; \text{ use } 1000 \mu\text{F}.$$

The high frequency pole is determined by the product of the desired high frequency pole,  $f_H$ , and the closed-loop gain,  $A_v$ . With a closed-loop gain of 1.35 and  $f_H = 100 \text{ kHz}$ , the resulting GBWP = 135 kHz which is much smaller than the LM4881 GBWP of 18 MHz. This figure displays that if a designer has a need to design an amplifier with a higher gain, the LM4881 can still be used without running into bandwidth limitations.

**Physical Dimensions** inches (millimeters)

unless otherwise noted

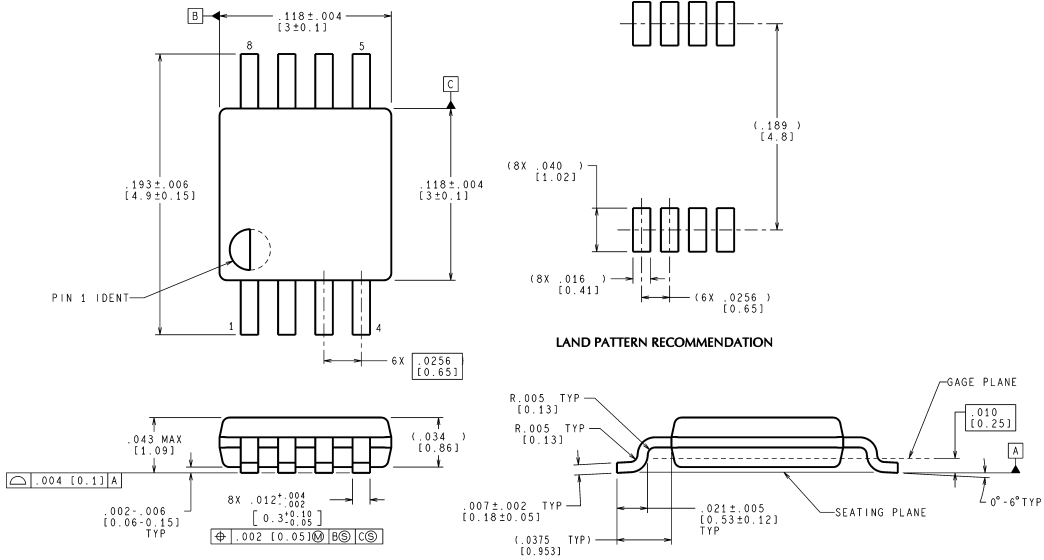

CONTROLLING DIMENSION IS INCH  
VALUES IN [ ] ARE MILLIMETERS

MUA08A (Rev E)

**Order Number LM4881MM**  
**NS Package Number MUA08A**

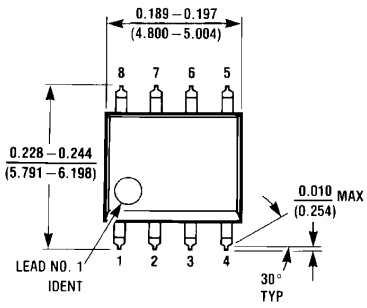

M08A (REV H)

**Order Number LM4881M**  
**NS Package Number M08A**

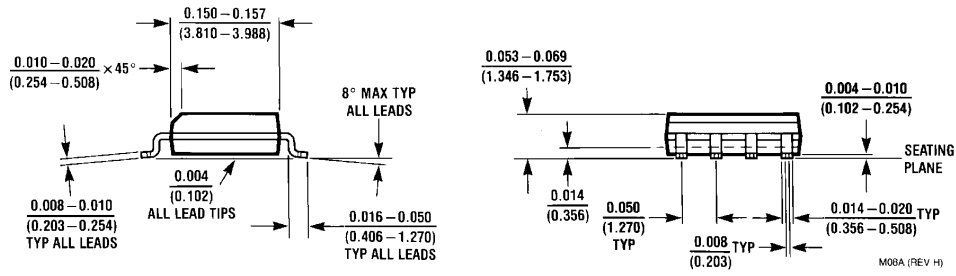

**Physical Dimensions** inches (millimeters) unless otherwise noted (Continued)

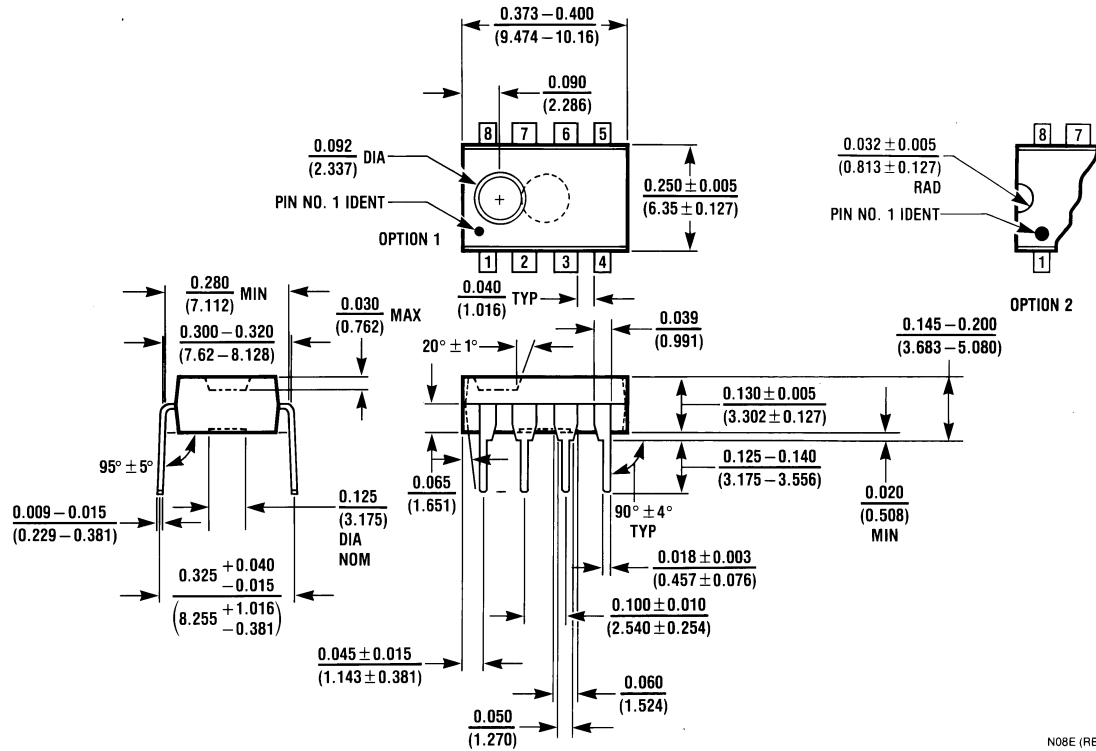

Order Number LM4881N  
NS Package Number N08E

N08E (REV F)

**LIFE SUPPORT POLICY**

NATIONAL'S PRODUCTS ARE NOT AUTHORIZED FOR USE AS CRITICAL COMPONENTS IN LIFE SUPPORT DEVICES OR SYSTEMS WITHOUT THE EXPRESS WRITTEN APPROVAL OF THE PRESIDENT AND GENERAL COUNSEL OF NATIONAL SEMICONDUCTOR CORPORATION. As used herein:

1. Life support devices or systems are devices or systems which, (a) are intended for surgical implant into the body, or (b) support or sustain life, and whose failure to perform when properly used in accordance with instructions for use provided in the labeling, can be reasonably expected to result in a significant injury to the user.
2. A critical component is any component of a life support device or system whose failure to perform can be reasonably expected to cause the failure of the life support device or system, or to affect its safety or effectiveness.

**BANNED SUBSTANCE COMPLIANCE**

National Semiconductor certifies that the products and packing materials meet the provisions of the Customer Products Stewardship Specification (CSP-9-111C2) and the Banned Substances and Materials of Interest Specification (CSP-9-111S2) and contain no "Banned Substances" as defined in CSP-9-111S2.

 **National Semiconductor**  
Americas Customer  
Support Center  
Email: [new.feedback@nsc.com](mailto:new.feedback@nsc.com)  
Tel: 1-800-272-9959

**National Semiconductor**  
Europe Customer Support Center  
Fax: +49 (0) 180-530 85 86  
Email: [europe.support@nsc.com](mailto:europe.support@nsc.com)  
Deutsch Tel: +49 (0) 69 9508 6208  
English Tel: +44 (0) 870 24 0 2171  
Français Tel: +33 (0) 1 41 91 8790

**National Semiconductor**  
Asia Pacific Customer  
Support Center  
Email: [ap.support@nsc.com](mailto:ap.support@nsc.com)

**National Semiconductor**  
Japan Customer Support Center  
Fax: 81-3-5639-7507  
Email: [jpn.feedback@nsc.com](mailto:jpn.feedback@nsc.com)  
Tel: 81-3-5639-7560

[www.national.com](http://www.national.com)

National does not assume any responsibility for use of any circuitry described, no circuit patent licenses are implied and National reserves the right at any time without notice to change said circuitry and specifications.