

4-bit REAL TIME CLOCK MODULE

RTC-62421  
RTC-62423

- Built-in crystal unit allows adjustment-free efficient operation.
- 24 h /12 h changeable and leap year automatically adjustable (Gregorian calendar).
- Pins and functions are compatible with the MSM6242 series.

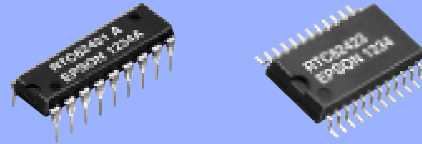

Actual size

RTC-62421

RTC-62423



Block diagram

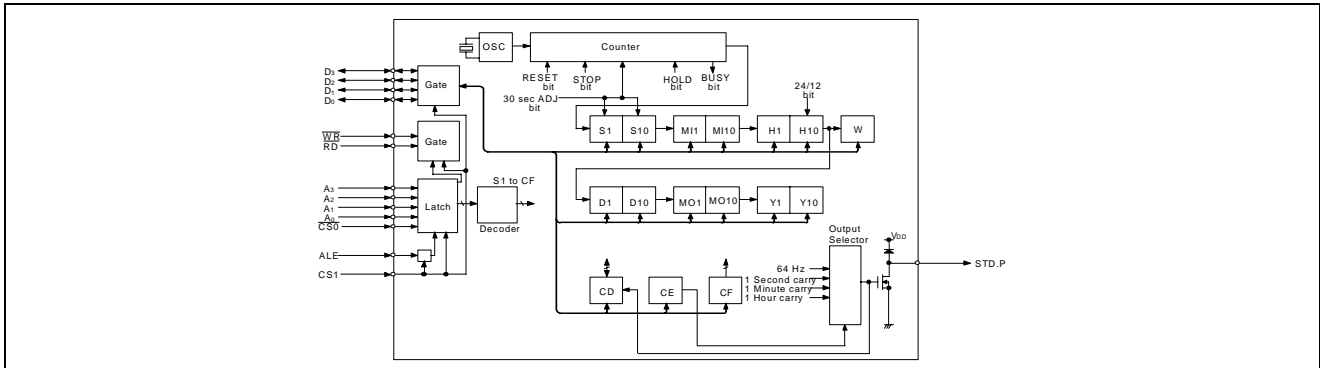

Terminal connection/External dimensions

(Unit:mm)

● RTC-62421 (DIP 18-pin)

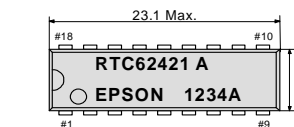

No.	Pin terminal	No.	Pin terminal
1	STD.P	18	VDD
2	/CS0	17	(VDD)
3	ALE	16	(VDD)
4	A0	15	CS1
5	A1	14	C0
6	A2	13	D1
7	A3	12	D2
8	/RD	11	D3
9	GND	10	/WR

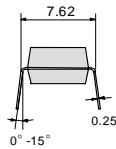
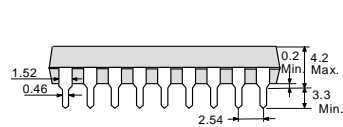

● RTC-62423 (SOP 24-pin)

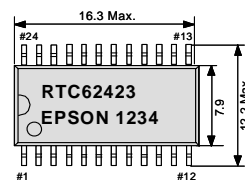

No.	Pin terminal	No.	Pin terminal
1	STD.P	24	VDD
2	/CS0	23	(VDD)
3	N.C.	22	(VDD)
4	ALE	21	N.C.
5	A0	20	CS1
6	N.C.	19	D0
7	A1	18	N.C.
8	N.C.	17	N.C.
9	A2	16	D1
10	A3	15	D2
11	/RD	14	D3
12	GND	13	/WR

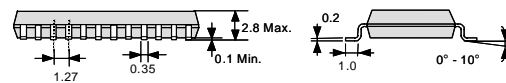

Metal may be exposed on the top or bottom of this product. This will not affect any quality, reliability or electrical spec.

Specifications (characteristics)

\*Refer to application manual for details.

Absolute Max. rating

Item	Symbol	Condition	Min.	Max.	Unit
Supply voltage	VDD	Ta=+25 °C	-0.3	+7.0	V
Input voltage	VIO	Ta=+25 °C	GND-0.3	VDD+0.3	
Storage temperature *	TSTG	RTC-62421	-55	+85	°C
		RTC-62423	-55	+125	

\*Stored as bare product after unpacking

Operating range

Item	Symbol	Condition	Min.	Max.	Unit
Power voltage	VDD	—	4.5	5.5	V
Clock voltage	VCLK	—	2.0	5.5	V
Operating temperature	TOPR	Stored as bare product after unpacking	-40	+85	°C

Frequency characteristics

Item	Symbol	Condition	Range	Unit
Frequency precision	Δf/f	Ta=+25 °C VDD=5.0 V	62421A	±10
			62421B	±50
			62423A	±20
			62423	±50
Frequency temperature characteristics	TOP	-10 °C to +70 °C (+25 °C)	+10 / -120	
		-40 °C to +85 °C(+25 °C)	+10 / -220	
Frequency voltage characteristics	f/V	Ta=+25 °C, VDD=4.5 V to 5.5 V	±5.0 Max.	×10 <sup>-6</sup> /V
Aging	fa	Ta=+25 °C, VDD=5.0 V, First year	±5.0 Max.	×10 <sup>-6</sup> /year

DC characteristics

Item	Symbol	Condition	Min.	Typ.	Max.	Unit	Applicable terminal
Current consumption	Ibd1	CS1= 0 V VDD=5 V	—	15	30	μA	—
	Ibd2	VDD=2 V	—	1	1.8		
HIGH input voltage (1)	VIH1	—	2.2	—	—	V	All inputs other than CS1
LOW input voltage (1)	VIL1	—	—	0.8	—		
LOW output voltage (1)	VOL1	IOL=2.5 mA	—	—	0.4	V	D0 to D3
HIGH output voltage	VOH	Ioh=-400 μA	2.4	—	—		
LOW output voltage (2)	VOL2	IOL=2.5 mA	—	—	0.4	V	STD.P
OFF leak current	IoffLK	V1=VDD/0 V	—	—	10/-10		
Input capacity	C1	Input frequency 1 MHz	—	5	—	pF	Input Pins
HIGH input voltage (2)	VIH2	VDD=2.0 V to 5.5 V	4/5 VDD	—	—	V	CS1
LOW input voltage (2)	VIL2	—	—	1/5 VDD	—		
Input leak current (1)	ILK1	V1=VDD/0 V	—	—	1/-1	μA	Input other than D0 to D3
Input leak current (2)	ILK2	—	—	—	10/-10		