

LED level meter driver, 5-point, VU scale

BA6124 / BA6124F

The BA6124 and BA6124F are driver ICs for LED VU level meters in stereo equipment and other display applications.

The ICs display the input level (range : -10dB to $+6\text{dB}$) on a 5-point, bar-type LED display.

The circuit includes a rectifier amplifier allowing direct AC input, and has constant-current outputs, so it can directly drive the LEDs without variations in LED current due to supply voltage fluctuations.

● Applications

VU meters, signal meters, and other display devices.

● Features

- 1) Rectifier amplifier allows either AC or DC input.
- 2) Constant-current outputs for constant LED current when the supply voltage fluctuates.
- 3) Built-in reference voltage means that power supply voltage fluctuations do not effect the display.
- 4) Wide operating voltage range (3.5V to 16V) for a wide range of applications.
- 5) Low PCB space requirements. Comes in a compact package and requires few external components.

● Block diagram

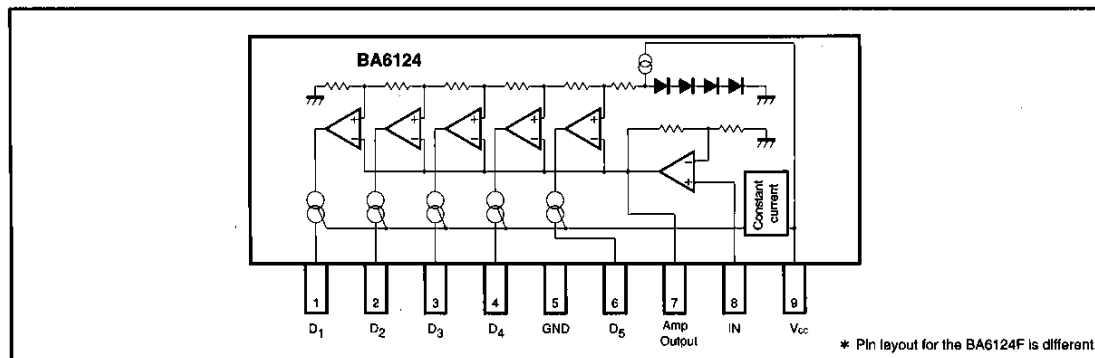

● Absolute maximum ratings (Ta = 25°C)

Parameter	Symbol	Limits	Unit
Supply voltage	V _{CC}	18	V
Power dissipation	BA6124	500*1	mW
	BA6124F	300*2	
Operating temperature	Topr	-25~60	°C
Storage temperature	Tstg	-55~125	°C
Junction temperature	TJ	150	°C

* 1 Reduced by 5mW for each increase in Ta of 1°C over 25°C.

* 2 Reduced by 3mW for each increase in Ta of 1°C over 25°C.

● Electrical characteristics (unless otherwise specified Ta = 25°C, V_{CC} = 6.0V, and f = 1kHz)

Parameter	Symbol	Min.	Typ.	Max.	Unit	Conditions	Measurement Circuit
Operating voltage range	V _{CC}	3.5	6	16	V	—	Fig.1
Quiescent current	I _Q	—	5	8	mA	V _{IN} =0V	Fig.1
Control level 1	V _{C1}	-11.5	-10	-8.5	dB	—	Fig.1
Control level 2	V _{C2}	-6	-5	-4	dB	—	Fig.1
Control level 3	V _{C3}	—	0	—	dB	Adjustment point	Fig.1
Control level 4	V _{C4}	2.5	3	3.5	dB	—	Fig.1
Control level 5	V _{C5}	5	6	7	dB	—	Fig.1
Sensitivity	V _{IN}	74	85	96	mV _{rms}	V _{C3} on level	Fig.1
LED current	I _{LED}	11	15	18.5	mA	—	Fig.1
Input bias current	I _{INO}	—	0.3	1.0	μA	—	Fig.1

● Measurement circuit

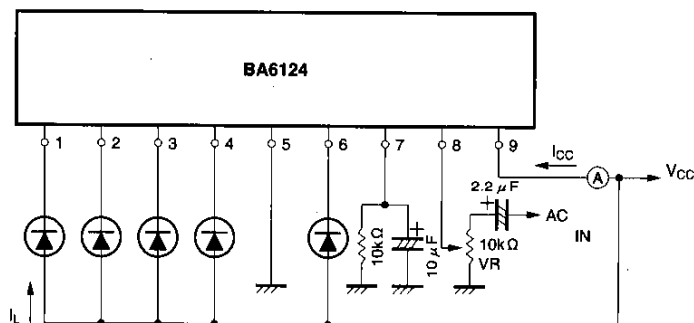

Fig. 1

●Electrical characteristics curves (Ta = 25°C)

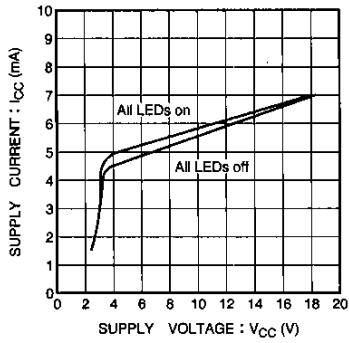

Fig. 2 Supply current vs. supply voltage

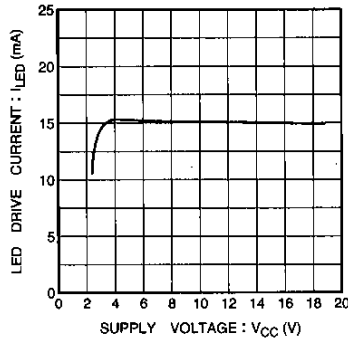

Fig. 3 LED drive current vs. supply voltage

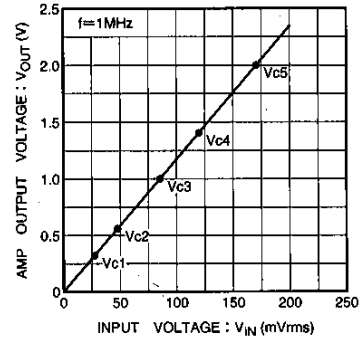

Fig. 4 Rectifier amplifier output voltage vs. input voltage

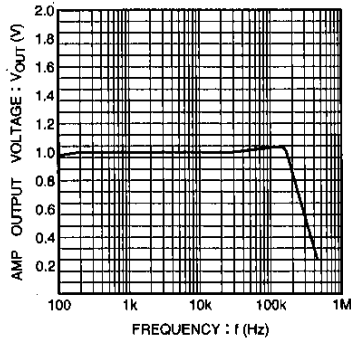

Fig. 5 Rectifier amplifier output voltage vs. frequency

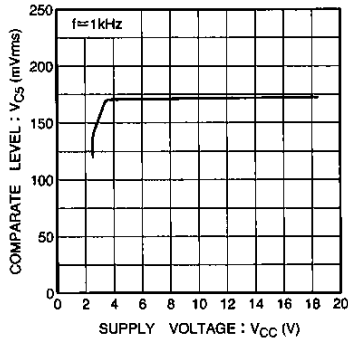

Fig. 6 Comparator level vs. supply voltage

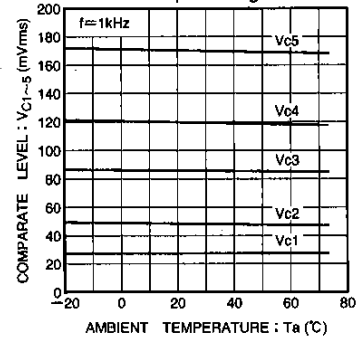

Fig. 7 Comparator level vs. ambient temperature

●Dimensions (Units: mm)

