

General Description

The LM2574 family is a series of easy to use fixed and adjustable switching voltage regulators. The LM2574 contains all of the active circuitry necessary to construct a stepdown (buck) switching regulator and requires a minimum of external components.

The LM2574 is available in 3.3V and 5V fixed output versions, or an adjustable version with an output voltage range of 1.23V to 37V. Output voltage is guaranteed to $\pm 4\%$ for specified input and load conditions.

The LM2574 can supply 0.5A while maintaining excellent line and load regulation. The output switch includes cycle-by-cycle current limiting, as well as thermal shutdown for full protection under fault conditions.

An external shutdown connection selects operating or standby modes. Standby current is less than 200 μ A.

Heat sinks are generally unnecessary due the regulator's high efficiency. Adequate heat transfer is usually provided by soldering all package pins to a printed circuit board.

The LM2574 includes internal frequency compensation and an internal 52kHz fixed frequency oscillator guaranteed to $\pm 10\%$ of the frequency.

Circuits constructed around the LM2574 use a standard series of inductors which are available from several different manufacturers.

All support documentation can be found on Micrel's web site at www.micrel.com.

Features

- 3.3V, 5V, 12V, and adjustable output versions
- Adjustable version output 1.23V to 37V $\pm 4\%$ max. over line and load conditions.
- Guaranteed 0.5A output current
- Wide input voltage, up to 40V
- Thermal shutdown and current limit protection
- Requires only 4 external components.
- Shutdown capability (standby mode)
- Low power standby mode < 200 μ A Typical
- High-efficiency
- 52kHz fixed frequency internal oscillator
- Uses standard inductors

Applications

- Simple high-efficiency step-down (buck) regulator
- Efficient pre-regulator for linear regulators
- On-card switching regulators
- Positive to negative converter (buck-boost)

Ordering Information

Part Number	Junction Temp. Range	Package
LM2574BN	-40°C to +85°C	8-pin Plastic DIP
LM2574-3.3BN	-40°C to +85°C	8-pin Plastic DIP
LM2574-5.0BN	-40°C to +85°C	8-pin Plastic DIP

Typical Application

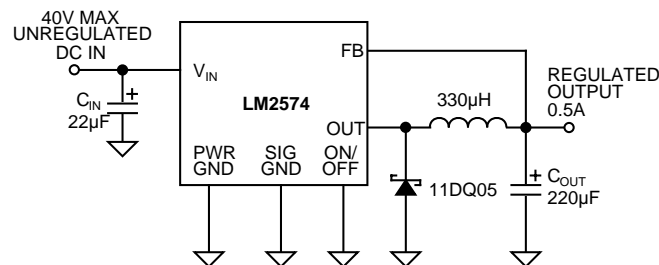
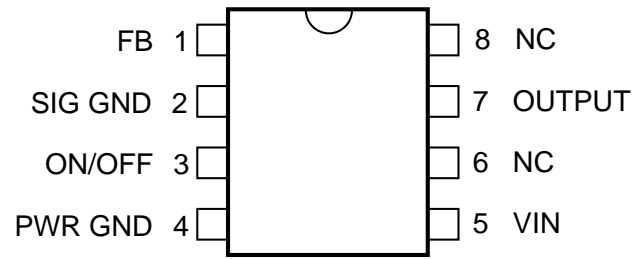

Figure 1. Fixed Output Regulator Circuit

Pin Configuration



8-Pin DIP (N)

Absolute Maximum Ratings⁽¹⁾

Maximum Supply Voltage	LM2574	45V
OFF Pin Input Voltage	$-0.3V \leq V \leq V_{IN}$	
Output Voltage to Ground (Steady State)	-1V	
Power Dissipation	Internally Limited	
Storage Temperature Range (T_S)	-65°C to $+150^\circ\text{C}$	
Minimum ESD Rating		
C = 100pF, R = 1.5k Ω	2kV	
FB Pin	1kV	
Lead Temperature (soldering, 10 sec.)	260 $^\circ\text{C}$	

Operating Ratings⁽¹⁾

Supply Voltage	LM2574	40V
Temperature Range	LM2574	$-40^\circ\text{C} \leq T_J \leq +125^\circ\text{C}$
Maximum Junction Temperature (T_J)	150 $^\circ\text{C}$	

Electrical Characteristics⁽²⁾

Specifications with standard typeface are for $T_J = 25^\circ\text{C}$, and those with boldface type apply over full Operating Temperature Range. Unless otherwise specified, $V_{IN} = 12\text{V}$, and $I_{LOAD} = 100\text{mA}$.

Symbol	Parameter	Condition	Min	Typ	Max	Units
System Parameters, Adjustable Regulators⁽³⁾, Test Circuit <i>Figure 2</i>						
V_{OUT}	Feedback Voltage	$V_{IN} = 12\text{V}$, $I_{LOAD} = 0.1\text{A}$, $V_{OUT} = 5\text{V}$	1.217	1.230	1.243	V
V_{OUT}	Feedback Voltage (LM2574)	$0.1\text{A} \leq I_{LOAD} \leq 0.5\text{A}$, $7\text{V} \leq V_{IN} \leq 40\text{V}$, $V_{OUT} = 5\text{V}$	1.193 1.180	1.230	1.267 1.280	V V
η	Efficiency	$V_{IN} = 12\text{V}$, $I_{LOAD} = 0.1\text{A}$, $V_{OUT} = 5\text{V}$		78		%
System Parameters, 3.3V Regulators⁽³⁾, Test Circuit <i>Figure 3</i>						
V_{OUT}	Output Voltage	$V_{IN} = 12\text{V}$, $I_{LOAD} = 0.1\text{A}$, $V_{OUT} = 3.3\text{V}$	3.234	3.3	3.366	V
V_{OUT}	Output Voltage (LM2574-3.3)	$0.1\text{A} \leq I_{LOAD} \leq 0.5\text{A}$, $4.75\text{V} \leq V_{IN} \leq 40\text{V}$, $V_{OUT} = 3.3\text{V}$	3.168 3.135	3.3	3.432 3.465	V V
η	Efficiency	$V_{IN} = 12\text{V}$, $I_{LOAD} = 0.1\text{A}$		73		%
System Parameters, 5V Regulators⁽³⁾, Test Circuit <i>Figure 3</i>						
V_{OUT}	Output Voltage	$V_{IN} = 12\text{V}$, $I_{LOAD} = 0.1\text{A}$, $V_{OUT} = 5\text{V}$	4.900	5.0	5.100	V
V_{OUT}	Output Voltage (LM2574-5.0)	$0.1\text{A} \leq I_{LOAD} \leq 0.5\text{A}$, $7\text{V} \leq V_{IN} \leq 40\text{V}$, $V_{OUT} = 5\text{V}$	4.800 4.750	5.0	5.200 5.250	V V
η	Efficiency	$V_{IN} = 12\text{V}$, $I_{LOAD} = 0.1\text{A}$, $V_{OUT} = 5\text{V}$		78		%

Notes:

1. "Absolute Maximum Ratings" indicate limits beyond which damage to the device may occur. "Operating Ratings" indicate for which the device is intended to be functional, but do not guarantee specific performance limits. For guaranteed specifications and test conditions, see "Electrical Characteristics."
2. All limits guaranteed at room temperature (standard type face) and at temperature extremes (bold type face). All room temperature limits are 100% production tested. All limits at temperature extremes are guaranteed via testing.
3. External components such as the catch diode, inductor, input and output capacitors can affect switching regulator system performance. When the LM2574 is used as shown in Figure 1 test circuit, system performance will be shown in system parameters section of "Electrical Characteristics."

Electrical Characteristics

Symbol	Parameter	Condition	Min	Typ	Max	Units
Device Parameters, Adjustable Regulator						
I_B	Feedback Bias Current	$V_{OUT} = 5V$		50	100 500	nA nA
Device Parameters, Fixed and Adjustable Regulators						
f_o	Oscillator Frequency	Note 8	47 42	52	58 63	kHz kHz
V_{SAT}	Saturation Voltage	$I_{OUT} = 0.5A^{(4)}$		0.8	1.2 1.4	V V
DC	Max Duty Cycle (ON)	Note 5	93	98		%
I_{CL}	Current Limit	Peak Current, $t_{ON} \leq 3\mu s^{(4)}$	0.7 0.65	1.0	1.6 1.8	A
I_L	Output Leakage Current	V_{IN} , Note 6 , Output = 0V Note 6 , Output = -1V		7.5	2 30	mA
I_Q	Quiescent Current	Note 6		5	10	mA
I_{STBY}	Standby Quiescent Current	ON/OFF Pin = 5V (OFF)		50	200	μA
θ_{JA}	Thermal Resistance	N Package, Junction to Ambient ⁽⁷⁾		85		$^{\circ}C/W$
On/Off Control, Fixed and Adjustable Regulators Test Circuit <i>Figures 2, 3</i>						
V_{IH}	ON/OFF Input Level	$V_{OUT} = 0V$	2.2 2.4	1.4		V V
V_{IL}	ON/OFF Input Level	$V_{OUT} = 5V$		1.2	1.0 0.8	V V
I_{IH}	ON/OFF Logic Current	ON/OFF = 5V (OFF)		4	30	μA
I_{IL}	ON/OFF Logic Current	ON/OFF = 0V (ON)		0.01	10	μA

Notes:

- Output (pin 2) sourcing current. No diode, inductor, or capacitor connected to input.
- Feedback (pin 4) removed from output and connected to 0V.
- Feedback (pin 4) removed from output and connected to 12V to force the output transistor OFF.
- Junction-to-ambient thermal resistance with approximately 1 square inches of PC board copper surrounding the leads.

Test Circuit

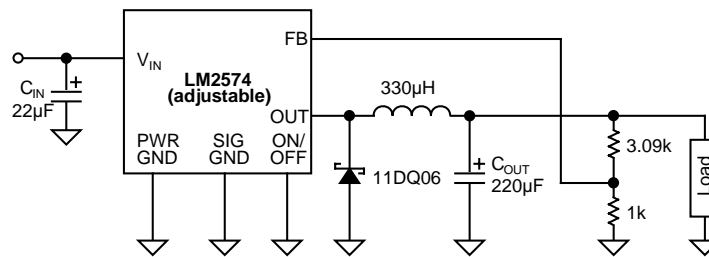

Figure 2. Adjustable Regulator Test Circuit

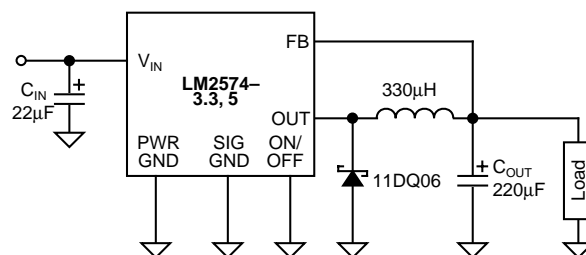
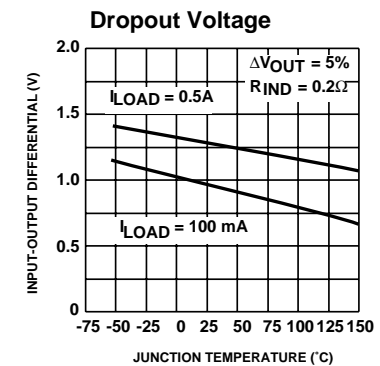
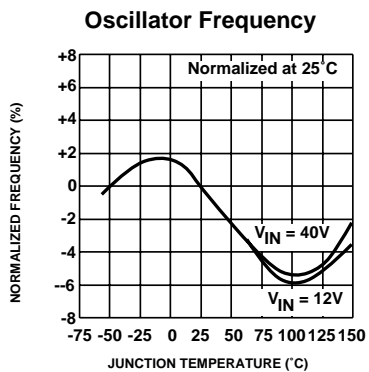
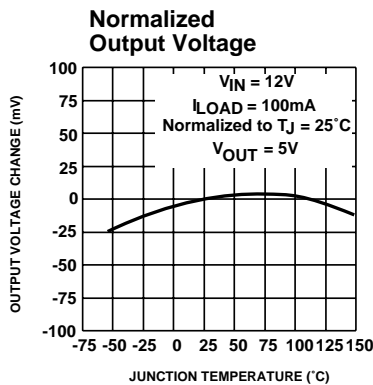
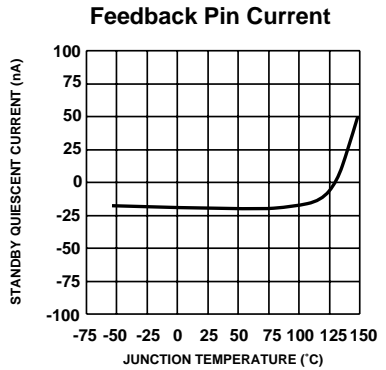
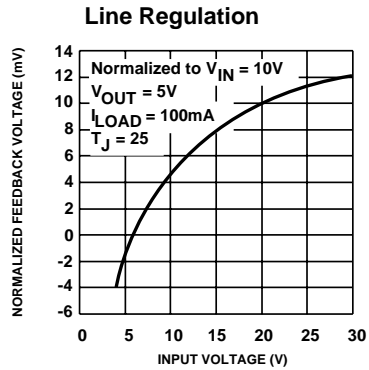
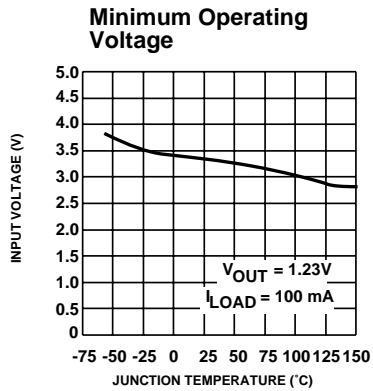
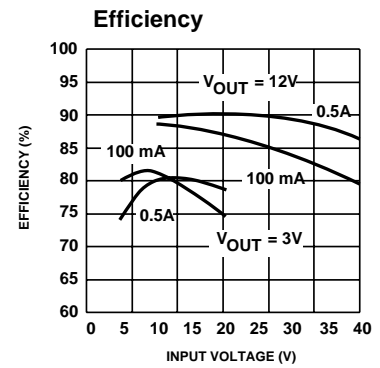
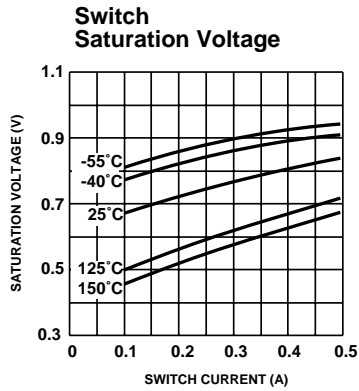
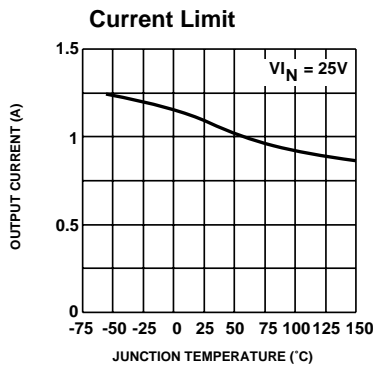
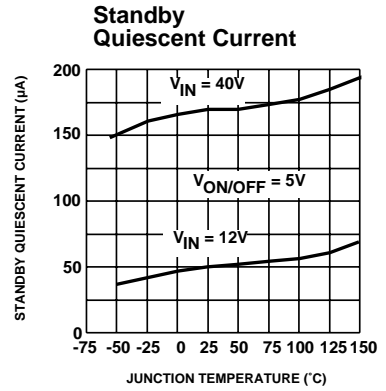
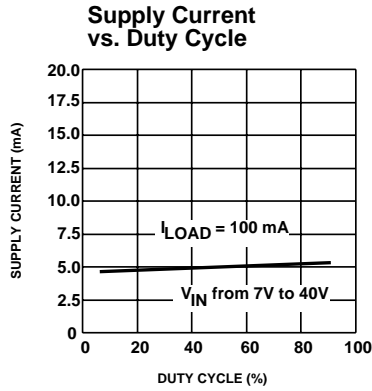
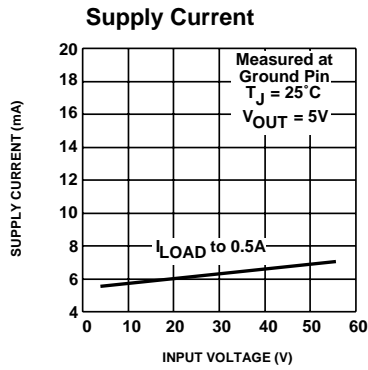
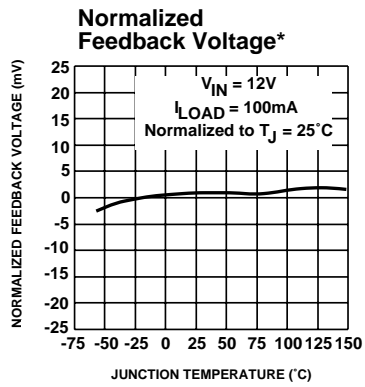

Figure 3. Fixed Regulator Test Circuit

Typical Characteristics (Circuit of Figure 1)



Typical Performance Characteristics (continued)



* Adjustable version only

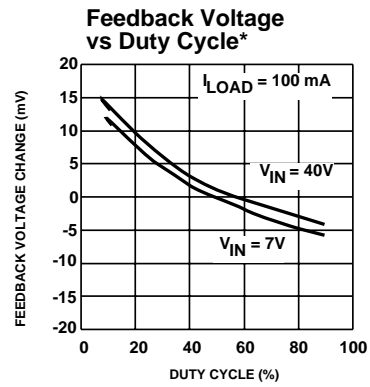

Block Diagrams

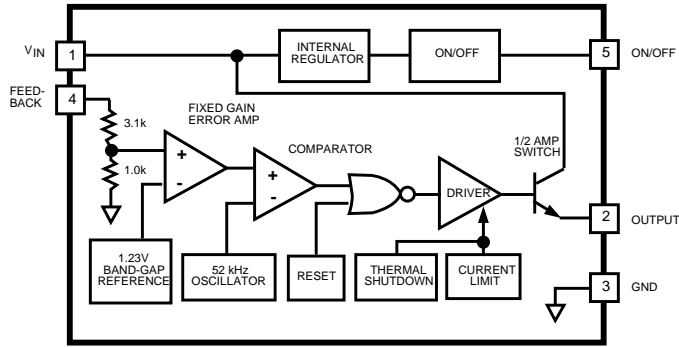

Note: Pin numbers are for the TO-220 package

Fixed Regulator

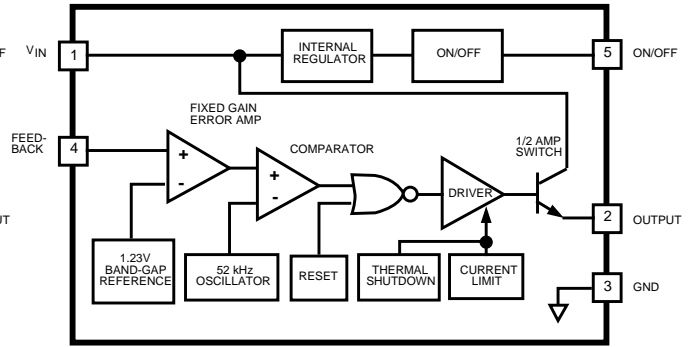

Adjustable Regulator

Package Information

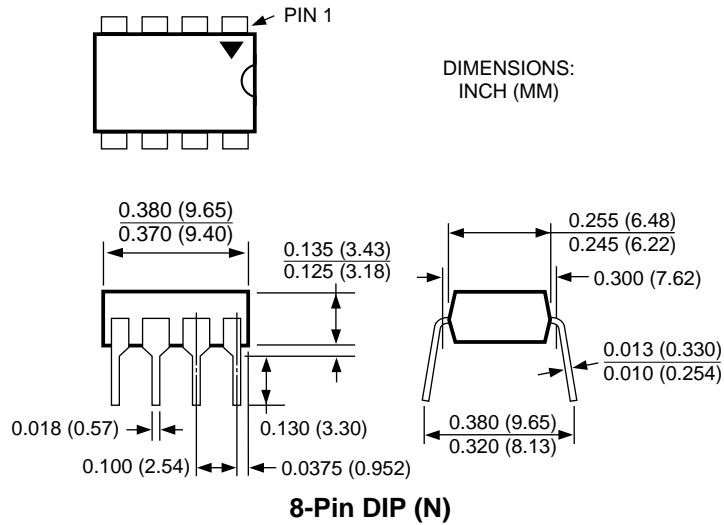

MICREL, INC. 1849 FORTUNE DRIVE SAN JOSE, CA 95131 USA

TEL + 1 (408) 944-0800 FAX + 1 (408) 944-0970 WEB <http://www.micrel.com>

The information furnished by Micrel in this data sheet is believed to be accurate and reliable. However, no responsibility is assumed by Micrel for its use. Micrel reserves the right to change circuitry and specifications at any time without notification to the customer.

Micrel Products are not designed or authorized for use as components in life support appliances, devices or systems where malfunction of a product can reasonably be expected to result in personal injury. Life support devices or systems are devices or systems that (a) are intended for surgical implant into the body or (b) support or sustain life, and whose failure to perform can be reasonably expected to result in a significant injury to the user. A Purchaser's use or sale of Micrel Products for use in life support appliances, devices or systems is at Purchaser's own risk and Purchaser agrees to fully indemnify Micrel for any damages resulting from such use or sale.

© 2003 Micrel, Incorporated.