

IC for CMOS System Reset Monolithic IC PST35XX, 36XX Series

March 21, 2004

Outline

This system reset IC, developed using the CMOS process, has a built-in delay function. Ultra-low consumption current of 1.0 μ A (typ.) has been achieved through use of the CMOS process. Also, detection voltage is high-precision detection of $\pm 2\%$. The small package SSON-4A (1.1 \times 1.4 \times 0.6mm) is used for space saving.

Features

- | | |
|---|--|
| 1. Ultra-low current consumption | 1.0 μ A typ. ($V_{DD} = V_S + 1V$) |
| 2. High-precision detection voltage | $\pm 2\%$ |
| 3. Operating range | 0.7 ~ 10V |
| 4. Wide operating temperature range | -30 ~ +85 $^{\circ}$ C |
| 5. Detection voltage | 0.9 ~ 6.0V (0.1V step) |
| 6. Delay time can be easily set with an external component (capacitor). | |

Packages

SOT-25A (PST35XXNR, PST36XXNR)
 SC-82ABA, SC-82ABB (PST36XXUR, PST36XXUR)
 SSON-4A

Applications

1. Reset circuits for microcomputers, CPUs and MPUs
2. Reset circuits for logic circuits
3. Battery voltage check circuits
4. Back-up power supply switching circuits
5. Level detection circuits
6. Delay time can be easily set with an external component (capacitor).

Pin Assignment

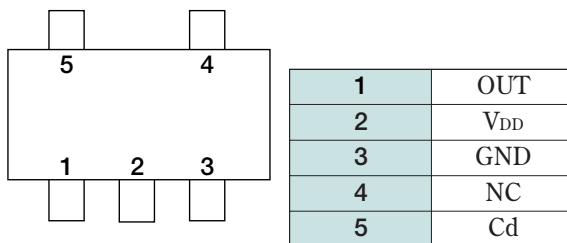

SOT-25A
(TOP VIEW)

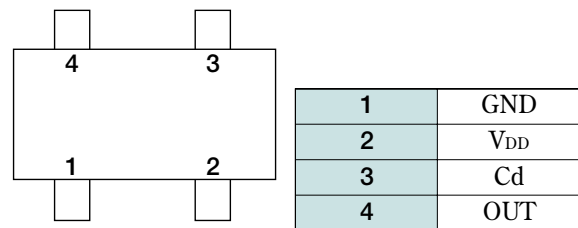

SC-82ABA
 SC-82ABB
(TOP VIEW)

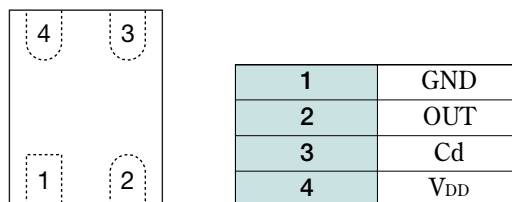

SSON-4A
(TOP VIEW)

Equivalent Circuit Diagram

■ PST35XXNR
(SOT-25A)

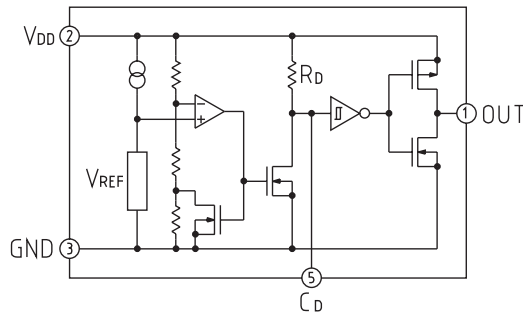

■ PST35XXUR
(SC-82ABA/-82ABB)

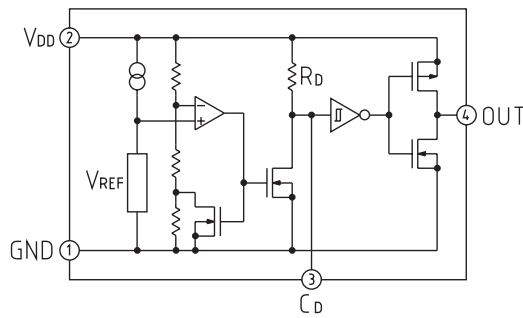

■ PST36XXNR
(SOT-25A)

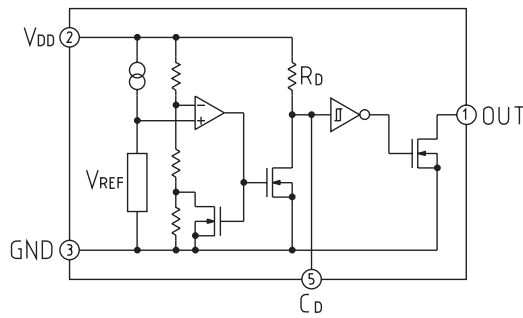

■ PST36XXUR
(SC-82ABA/-82ABB)

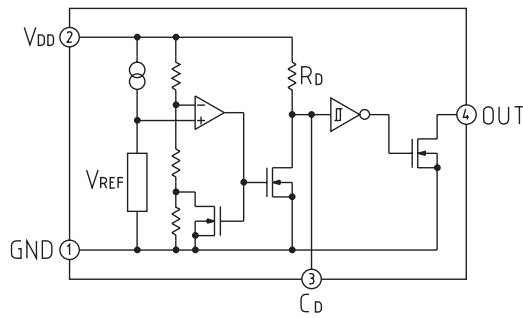

■ PST35XXRX
(SSON-4A)

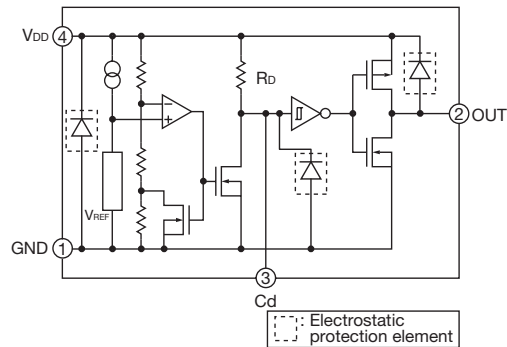

--- Electrostatic protection element

Pin Explanation

Pin No.	Pin Name	Function
1	GND	GND Pin
2	OUT	Reset Signal Output Pin
3	Cd	Capacitor Connect Pin with Delay
4	V _{DD}	V _{DD} Pin / Voltage Detect Pin

Recommended Operating Conditions

■ PST35XX UR/NR

Item	Symbol	Rating	Units
Operating temperature	T _{OPT}	-30~+85	°C
Power supply voltage	V _{DD}	+0.70~+10	V

■ PST36XX UR/NR

Item	Symbol	Rating	Units
Operating temperature	T _{OPT}	-30~+85	°C
Power supply voltage	V _{DD}	+0.70~+10	V

Absolute Maximum Ratings (Ta=25°C)

■ PST35XX UR/NR

Item	Symbol	Rating	Unit
Storage temperature	T _{STG}	-40~+125	°C
Operating temperature	T _{OPR}	-30~+85	°C
Power supply voltage	V _{DD max.}	+12	V
Output voltage	V _{OUT}	V _{SS} +0.3	V
Output current	I _{OUT}	70	mA
Allowable loss	P _d	150	mW
CD Pin Input Voltage	V _{CD}	V _{SS} -0.3~V _{DD} +0.3	V

■ PST36XX UR/NR

Item	Symbol	Rating	Unit
Storage temperature	T _{STG}	-40~+125	°C
Operating temperature	T _{OPR}	-30~+85	°C
Power supply voltage	V _{DD max.}	+12	V
Output voltage	V _{OUT}	V _{SS} -0.3~+12	V
Output current	I _{OUT}	70	mA
Allowable loss	P _d	150	mW
CD Pin Input Voltage	V _{CD}	V _{SS} -0.3~V _{DD} +0.3	V

Electrical Characteristics

(1) Detection Voltage Table Ta=25°C

Detection voltage	SOT-25A		SC-82AB	
	CMOS output	N-ch open drain	CMOS output	N-ch open drain
0.900 ± 2%	PST3509NR	PST3609NR	PST3509UR	PST3609UR
1.000 ± 2%	PST3510NR	PST3610NR	PST3510UR	PST3610UR
1.100 ± 2%	PST3511NR	PST3611NR	PST3511UR	PST3611UR
1.200 ± 2%	PST3512NR	PST3612NR	PST3512UR	PST3612UR
1.300 ± 2%	PST3513NR	PST3613NR	PST3513UR	PST3613UR
1.400 ± 2%	PST3514NR	PST3614NR	PST3514UR	PST3614UR
1.500 ± 2%	PST3515NR	PST3615NR	PST3515UR	PST3615UR
1.600 ± 2%	PST3516NR	PST3616NR	PST3516UR	PST3616UR
1.700 ± 2%	PST3517NR	PST3617NR	PST3517UR	PST3617UR
1.800 ± 2%	PST3518NR	PST3618NR	PST3518UR	PST3618UR
1.900 ± 2%	PST3519NR	PST3619NR	PST3519UR	PST3619UR
2.000 ± 2%	PST3520NR	PST3620NR	PST3520UR	PST3620UR
2.100 ± 2%	PST3521NR	PST3621NR	PST3521UR	PST3621UR
2.200 ± 2%	PST3522NR	PST3622NR	PST3522UR	PST3622UR
2.300 ± 2%	PST3523NR	PST3623NR	PST3523UR	PST3623UR
2.400 ± 2%	PST3524NR	PST3624NR	PST3524UR	PST3624UR
2.500 ± 2%	PST3525NR	PST3625NR	PST3525UR	PST3625UR
2.600 ± 2%	PST3526NR	PST3626NR	PST3526UR	PST3626UR
2.700 ± 2%	PST3527NR	PST3627NR	PST3527UR	PST3627UR
2.800 ± 2%	PST3528NR	PST3628NR	PST3528UR	PST3628UR
2.900 ± 2%	PST3529NR	PST3629NR	PST3529UR	PST3629UR
3.000 ± 2%	PST3530NR	PST3630NR	PST3530UR	PST3630UR
3.100 ± 2%	PST3531NR	PST3631NR	PST3531UR	PST3631UR
3.200 ± 2%	PST3532NR	PST3632NR	PST3532UR	PST3632UR
3.300 ± 2%	PST3533NR	PST3633NR	PST3533UR	PST3633UR
3.400 ± 2%	PST3534NR	PST3634NR	PST3534UR	PST3634UR
3.500 ± 2%	PST3535NR	PST3635NR	PST3535UR	PST3635UR
3.600 ± 2%	PST3536NR	PST3636NR	PST3536UR	PST3636UR
3.700 ± 2%	PST3537NR	PST3637NR	PST3537UR	PST3637UR
3.800 ± 2%	PST3538NR	PST3638NR	PST3538UR	PST3638UR
3.900 ± 2%	PST3539NR	PST3639NR	PST3539UR	PST3639UR
4.000 ± 2%	PST3540NR	PST3640NR	PST3540UR	PST3640UR
4.100 ± 2%	PST3541NR	PST3641NR	PST3541UR	PST3641UR
4.200 ± 2%	PST3542NR	PST3642NR	PST3542UR	PST3642UR
4.300 ± 2%	PST3543NR	PST3643NR	PST3543UR	PST3643UR
4.400 ± 2%	PST3544NR	PST3644NR	PST3544UR	PST3644UR
4.500 ± 2%	PST3545NR	PST3645NR	PST3545UR	PST3645UR
4.600 ± 2%	PST3546NR	PST3646NR	PST3546UR	PST3646UR
4.700 ± 2%	PST3547NR	PST3647NR	PST3547UR	PST3647UR
4.800 ± 2%	PST3548NR	PST3648NR	PST3548UR	PST3648UR
4.900 ± 2%	PST3549NR	PST3649NR	PST3549UR	PST3649UR
5.000 ± 2%	PST3550NR	PST3650NR	PST3550UR	PST3650UR
5.100 ± 2%	PST3551NR	PST3651NR	PST3551UR	PST3651UR
5.200 ± 2%	PST3552NR	PST3652NR	PST3552UR	PST3652UR
5.300 ± 2%	PST3553NR	PST3653NR	PST3553UR	PST3653UR
5.400 ± 2%	PST3554NR	PST3654NR	PST3554UR	PST3654UR
5.500 ± 2%	PST3555NR	PST3655NR	PST3555UR	PST3655UR
5.600 ± 2%	PST3556NR	PST3656NR	PST3556UR	PST3656UR
5.700 ± 2%	PST3557NR	PST3657NR	PST3557UR	PST3657UR
5.800 ± 2%	PST3558NR	PST3658NR	PST3558UR	PST3658UR
5.900 ± 2%	PST3559NR	PST3659NR	PST3559UR	PST3659UR
6.000 ± 2%	PST3560NR	PST3660NR	PST3560UR	PST3660UR

Detection voltage measurement conditions: V_{DD} = 9V→0V, measurement circuit 1

Electrical Characteristics (Except where noted otherwise, Ta=25°C)

Item	Symbol	Measurement conditions	Min.	Typ.	Max.	Unit
Hysteresis voltage	V _{HYS}		V _S ×0.03	V _S ×0.05	V _S ×0.07	V
Detection voltage temperature coefficient	V _S /ΔT	-30°C ≤ T _{OPT} ≤ 85°C		±0.01		%/°C
Consumption current 1	I _{SS1}	V _{DD} = (-V _{DET}) -0.13V		4	8	μA
Consumption current 2	I _{SS2}	V _{DD} = (-V _{DET}) +2.0V		1.2	3.6	μA
Output voltage 1	I _{OUT1}	Nch: V _{DS} =0.05V, V _{DD} =0.7V	0.01	0.05		mA
Output voltage 2	I _{OUT2}	V _{DD} =1.5V, Nch: V _{DS} =0.5V, V _{DD} =1.5V	1.0	2.0		mA
Output voltage 3	I _{OUT3}	V _{DD} =4.5V, Pch: V _{DS} =-2.1V	1.0	2.0		mA
Delay terminal threshold voltage	V _{TCD}	V _{DD} = (-V _{DET}) × 1.1V	V _{DD} ×0.4	V _{DD} ×0.5	V _{DD} ×0.6	V
Delay terminal output current 1	I _{CD1}	V _{DS} =0.1V, V _{DD} =0.7V	2	30		μA
Delay terminal output current 2	I _{CD2}	V _{DS} =0.5V, V _{DD} =1.5V	200	800		μA
Minimum operating voltage 1	V _{DDL1}	V _{OUT} ≤ 0.1V, T _{OPT} =25°C		0.55	0.70	V
Minimum operating voltage 2	V _{DDL2}	V _{OUT} ≤ 0.1V, -30°C ≤ T _{OPT} ≤ 85°C		0.65	0.80	V
Delay circuit resistance	R _D		0.5	1.0	2.0	MΩ
Leak current	I _{LEAK}	V _{DD} =10V, V _{CD} =10V, V _{DS} =10V			0.1	μA

Note: Output current is only CMOS output (PST3530NR).

Measuring Circuit

■ PST35XXNR

(1)

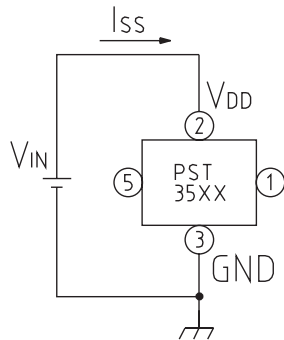

(2)

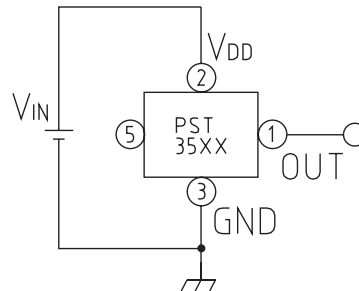

(3)

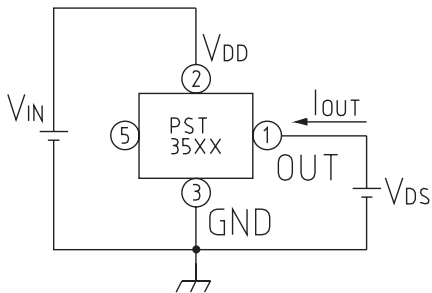

(4)

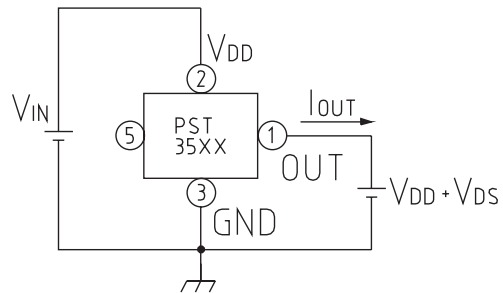

(5)

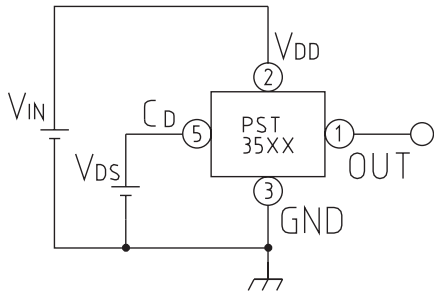

(6)

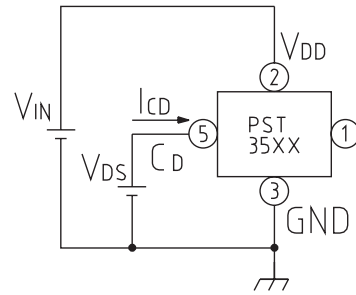

(7)

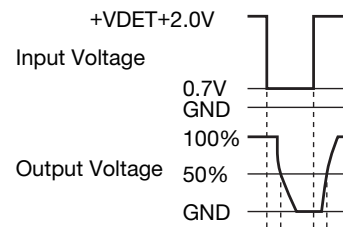
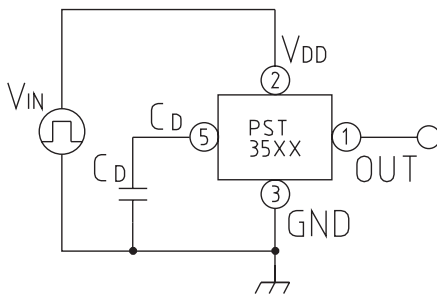

Delay Time Current

■ PST36XXNR

(1)

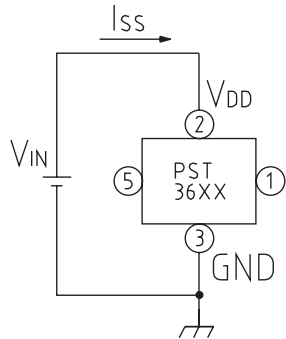

(2)

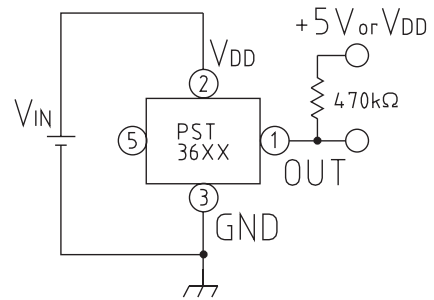

(3)

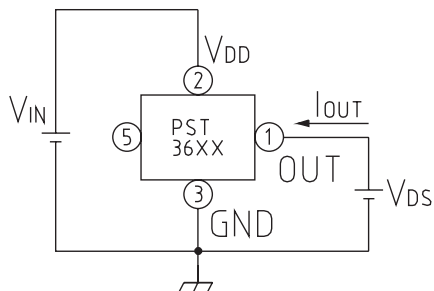

(4)

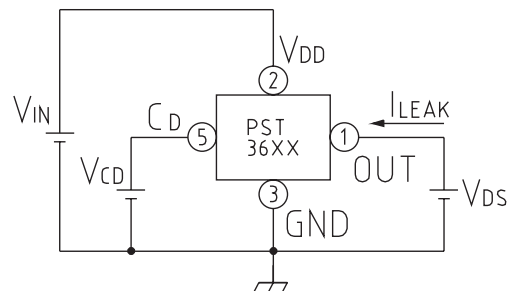

(5)

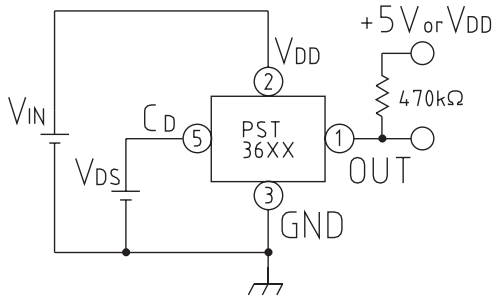

(6)

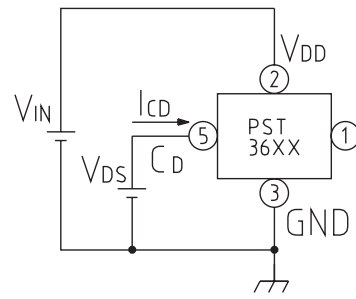

(7)

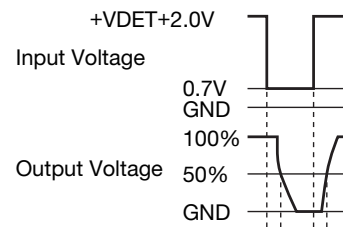
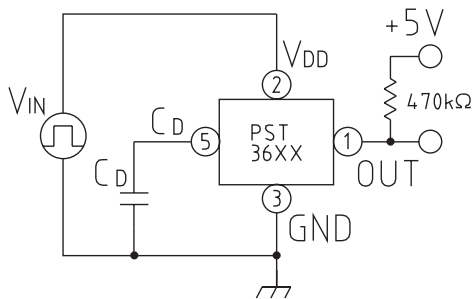

Delay Time Current

Timing Chart

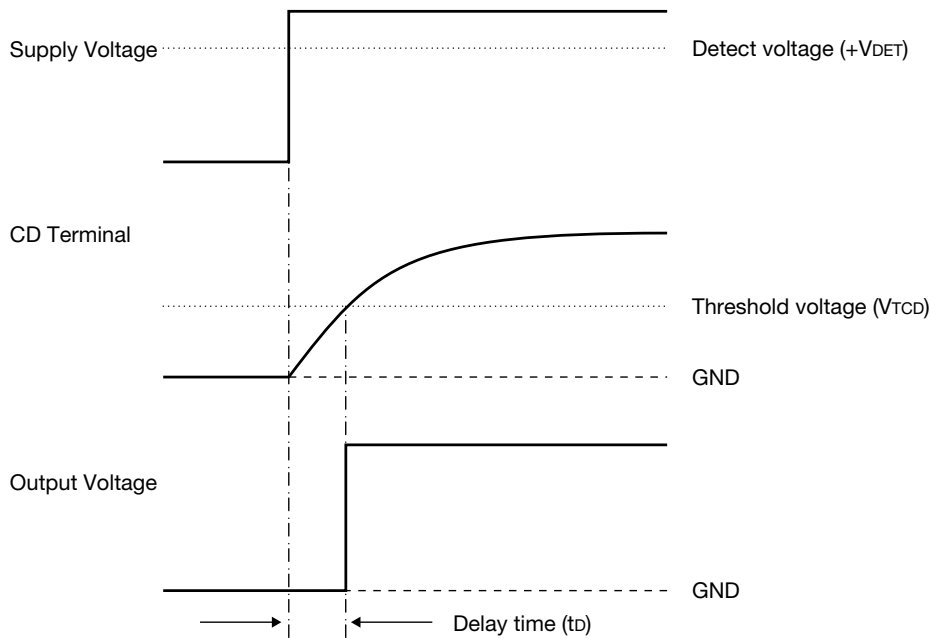

Delay Time (td) $tD \approx 0.69 \times R_D \times C_D$ (F) (s) R_D : C_D Pin Resistance C_D : Capacitor

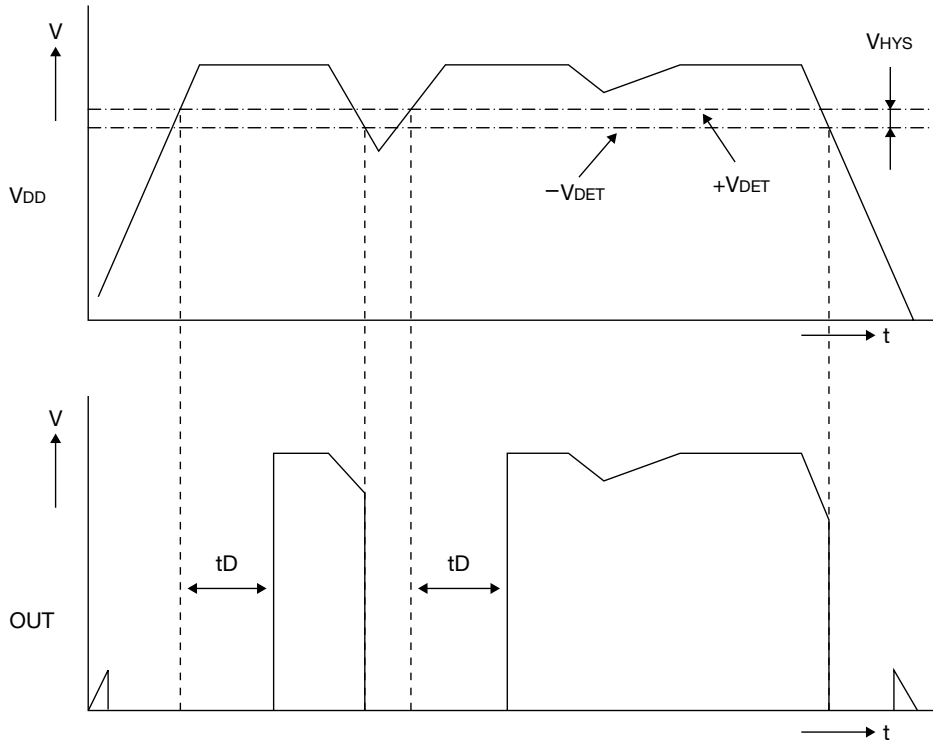

Application Circuits

■ PST35XX UR/NR

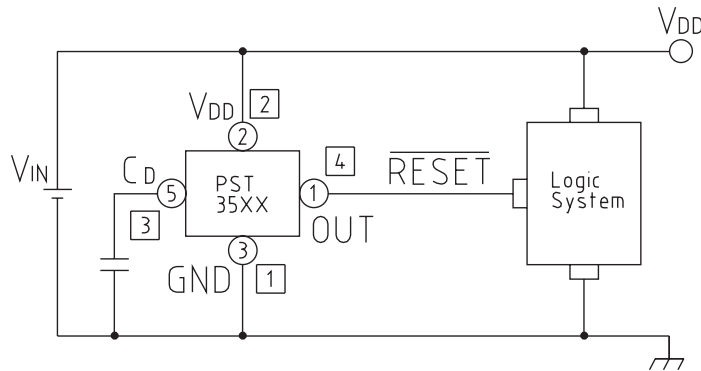

Please be advised that Mitsumi Electric Co., Ltd. is not liable for any accidents or damage caused as a result of the use of this circuit.

In the event a problem which may affect industrial property or any other rights of us or a third party is encountered during the use of information described in these circuit, Mitsumi Electric Co., Ltd. shall not be liable for any such problem, nor grant a license therefor.

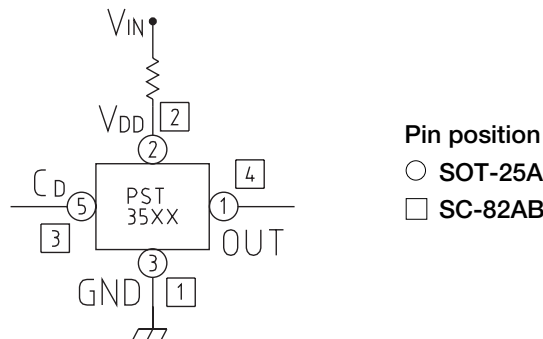

Please note that there is any possibility of circuit oscillation when resistance put in the line VIN.

Characteristics (For products with PST3509 detection voltage 0.9V typ. CMOS output)

■ Output voltage vs input voltage

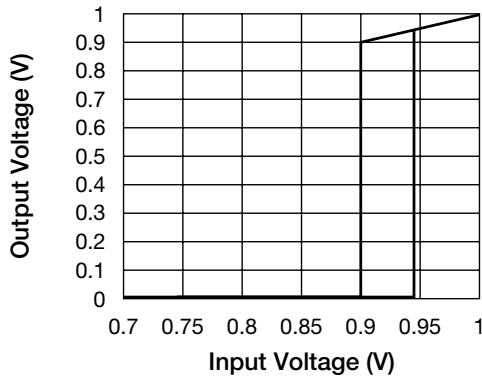

■ Consumption current vs input voltage

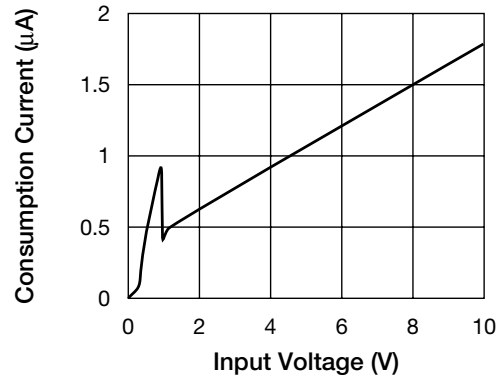

■ CD Pin output current vs input voltage

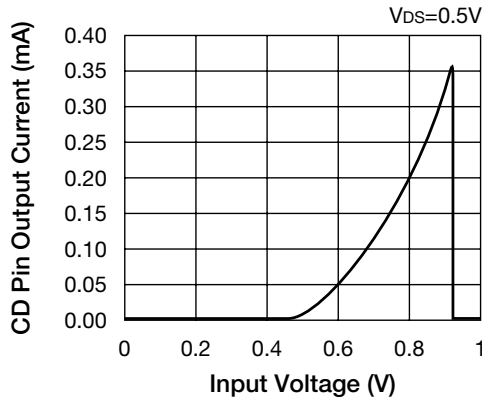

■ Delay time vs CD

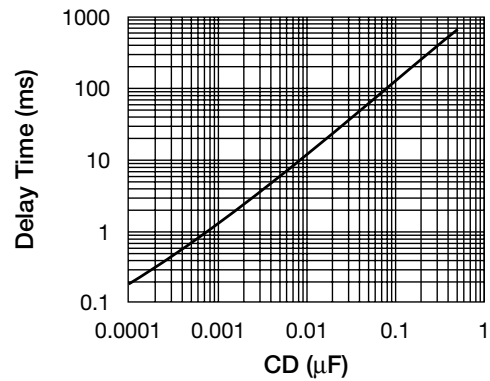

■ Detecting voltage vs temperature

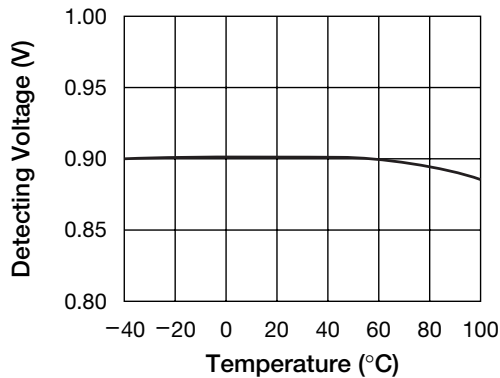

■ Hysteresis voltage vs temperature

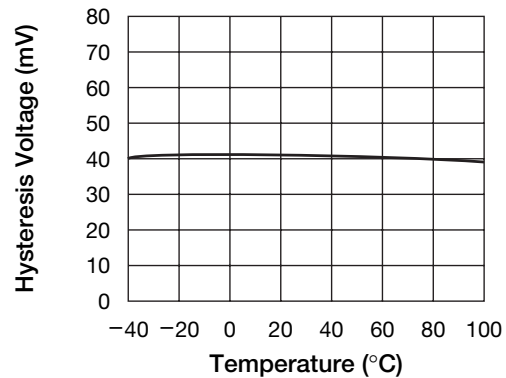

Note: These are typical characteristics.

■ Output current 1 vs temperature

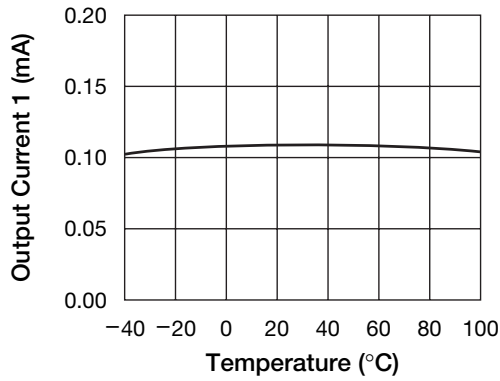

■ Output current 2 vs temperature

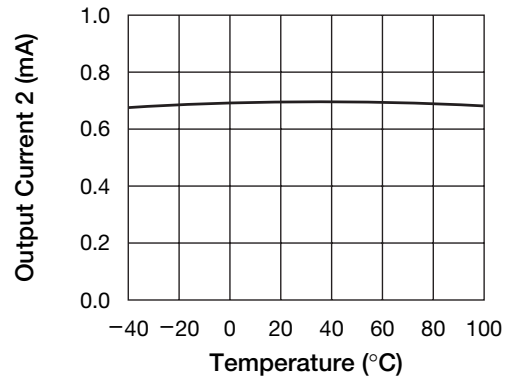

■ Output current 3 vs temperature

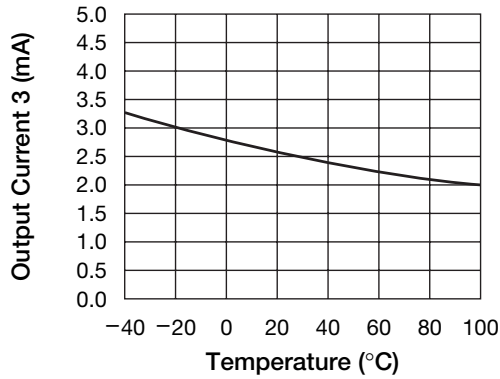

■ CD Pin threshold voltage vs temperature

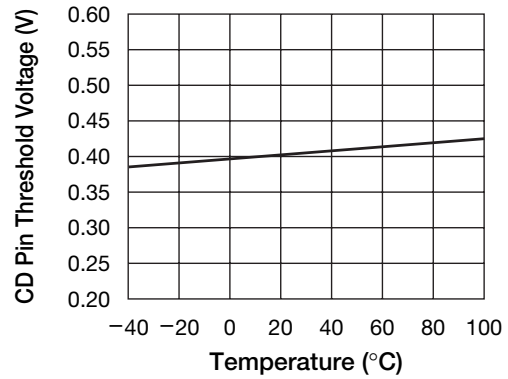

■ CD Pin output current 1 vs temperature

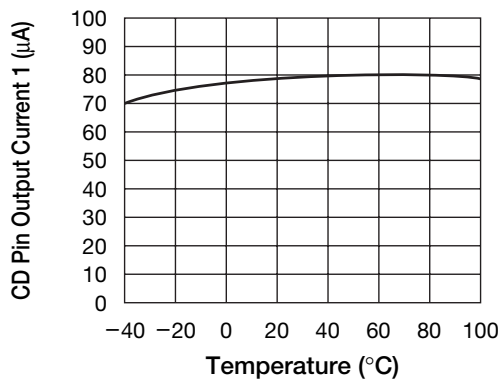

■ CD Pin output current 2 vs temperature

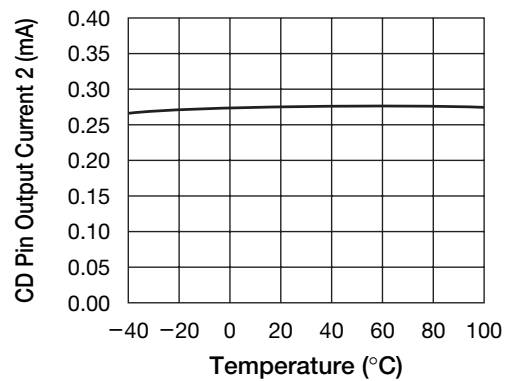

Note: These are typical characteristics.

Characteristics (For products with PST3528 detection voltage 2.8V typ. CMOS output)

■ Output voltage vs input voltage

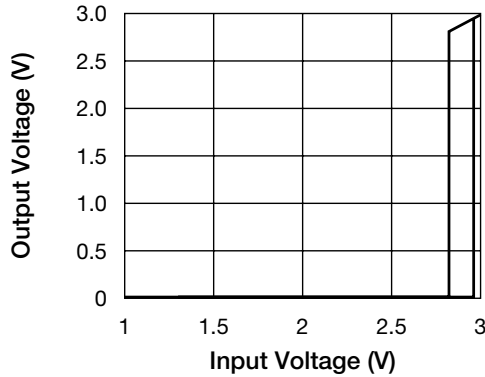

■ Consumption current vs input voltage

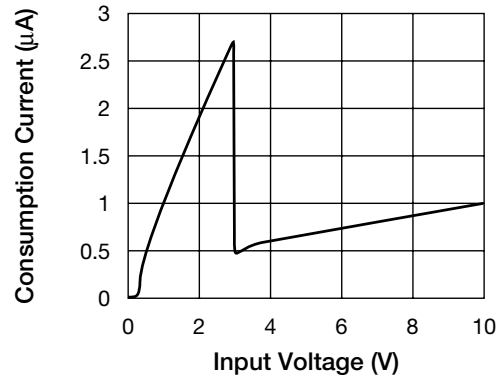

■ CD pin output current vs input voltage

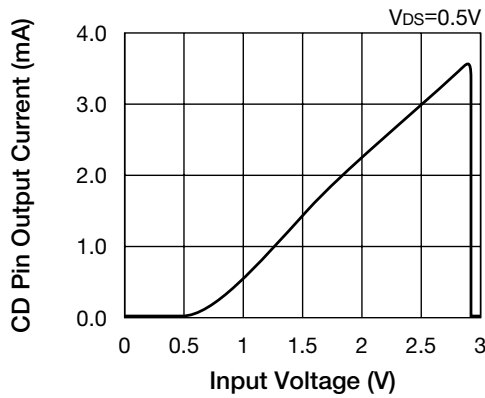

■ Delay time vs CD

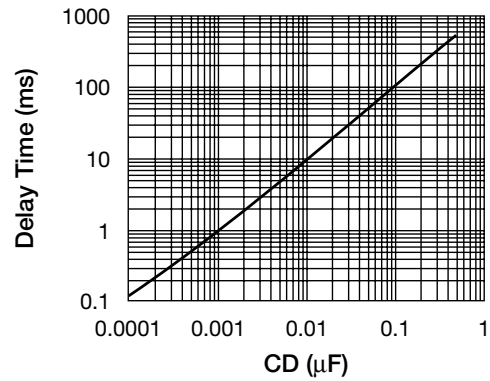

■ Detecting voltage vs temperature

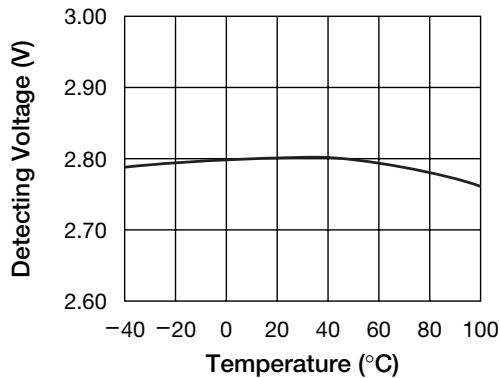

■ Hysteresis voltage vs temperature

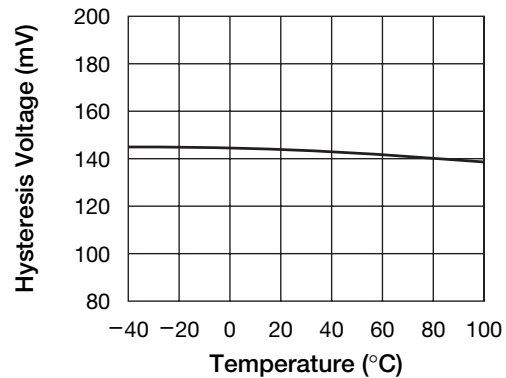

Note: These are typical characteristics.

■ Output current 1 vs temperature

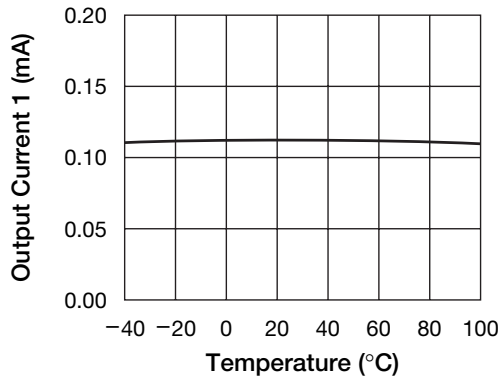

■ Output current 2 vs temperature

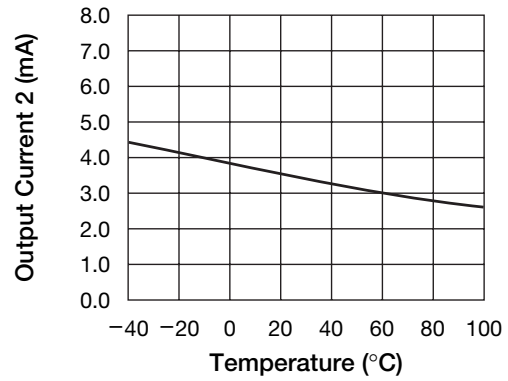

■ Output current 3 vs temperature

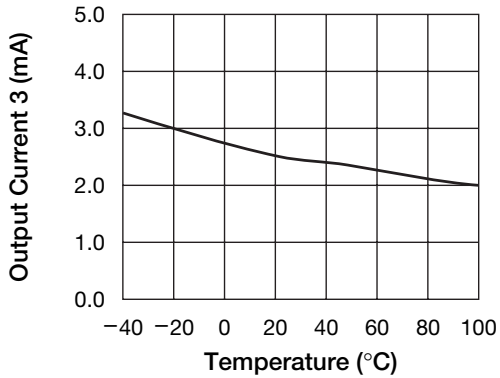

■ CD Pin threshold voltage vs temperature

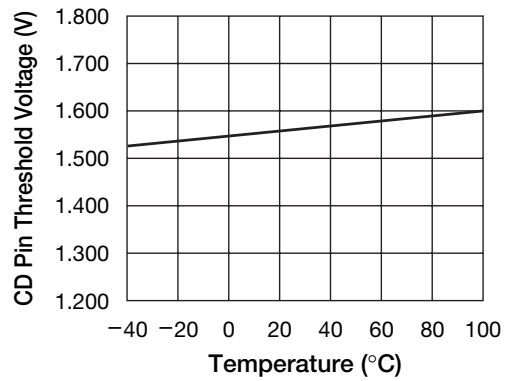

■ CD Pin output current 1 vs temperature

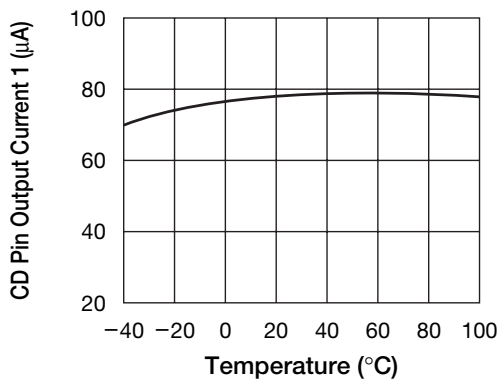

■ CD Pin output current 2 vs temperature

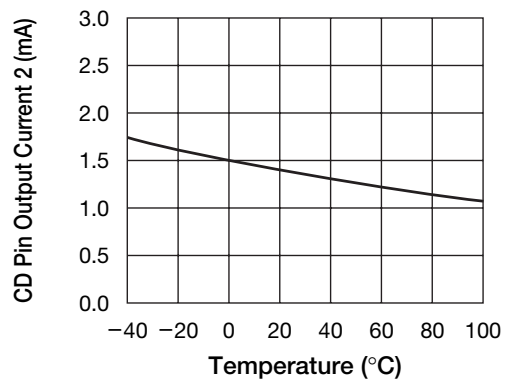

Note: These are typical characteristics.

Characteristics (For products with PST3546 detection voltage 4.6V typ. CMOS output)

■ Output voltage vs input voltage

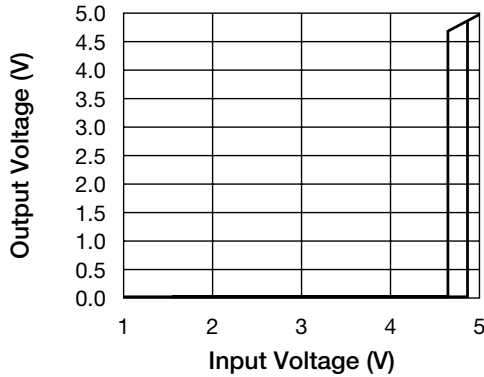

■ Consumption current vs input voltage

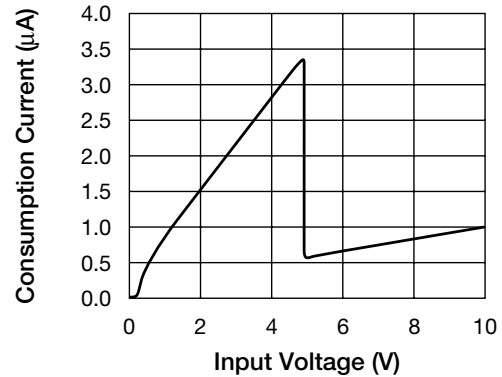

■ CD Pin output current vs input voltage

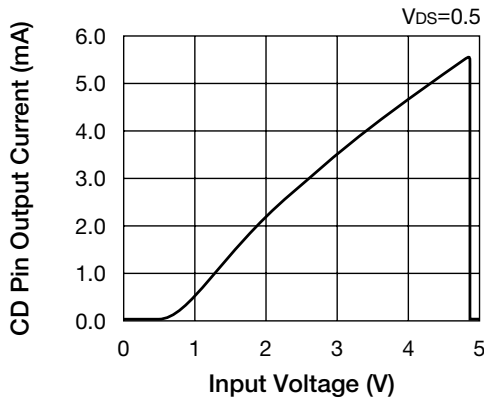

■ Delay time vs CD

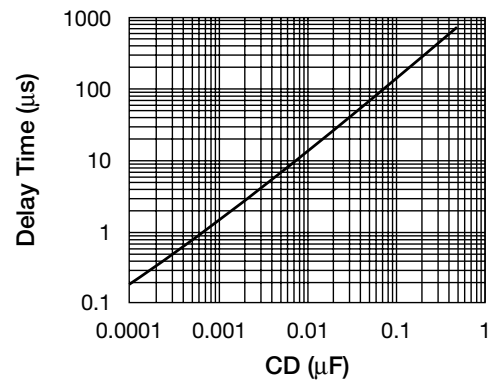

■ Detecting voltage vs temperature

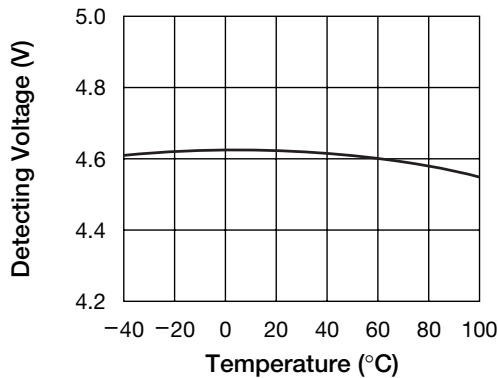

■ Hysteresis voltage vs temperature

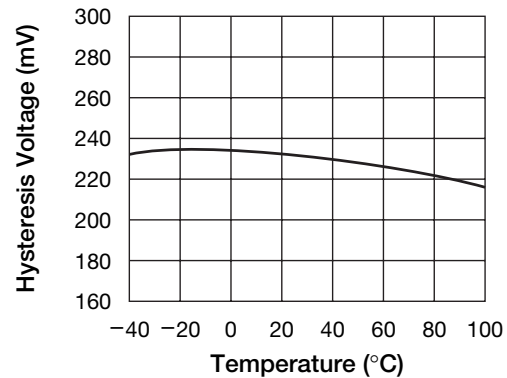

Note: These are typical characteristics.

■ Output current 1 vs temperature

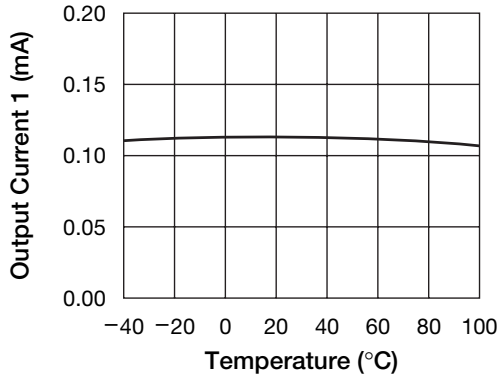

■ Output current 2 vs temperature

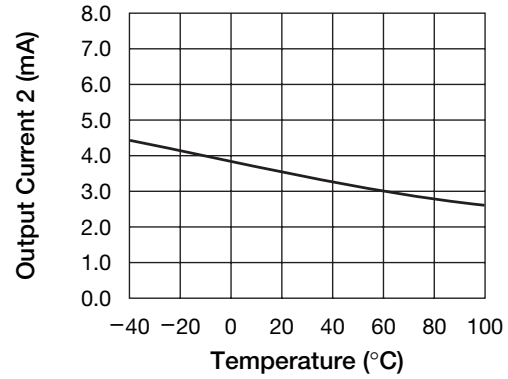

■ Output current 3 vs temperature

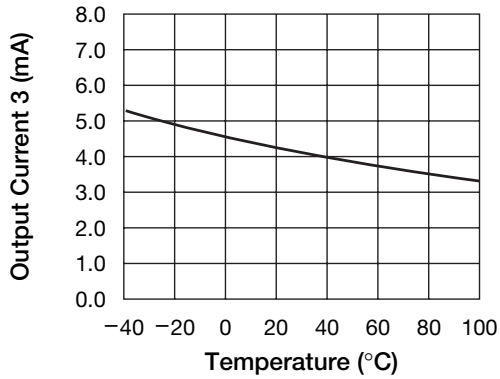

■ CD Pin threshold voltage vs temperature

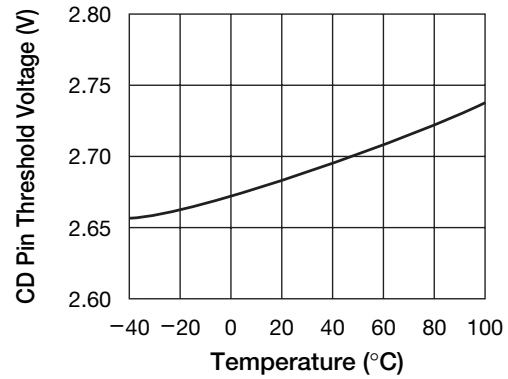

■ CD Pin output current 1 vs temperature

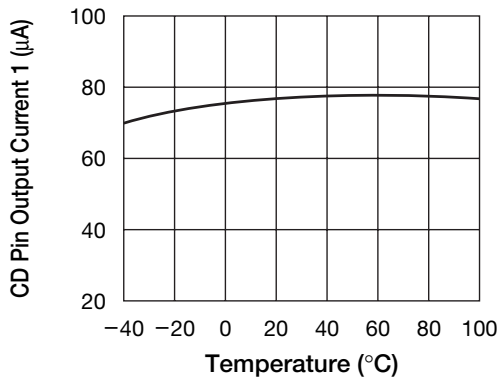

■ CD Pin output current 2 vs temperature

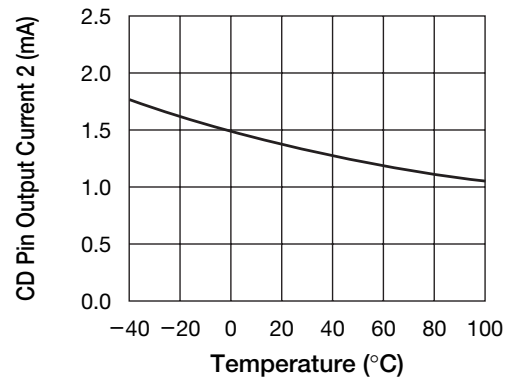

Note: These are typical characteristics.

Characteristics (For products with PST3609 detection voltage 0.9V typ. N-ch open drain)

■ Output voltage vs input voltage

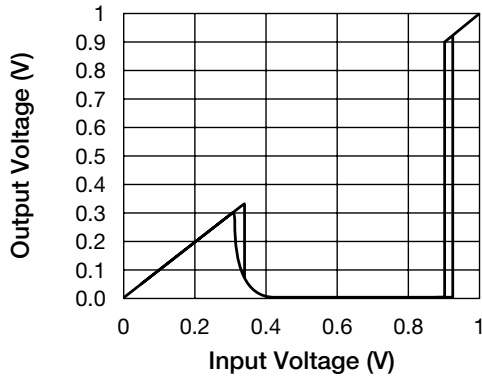

■ Consumption current vs input voltage

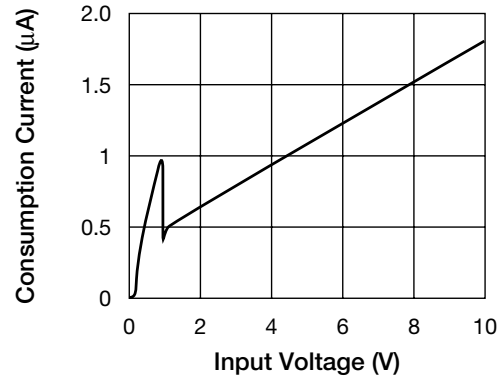

■ CD Pin output current vs input voltage

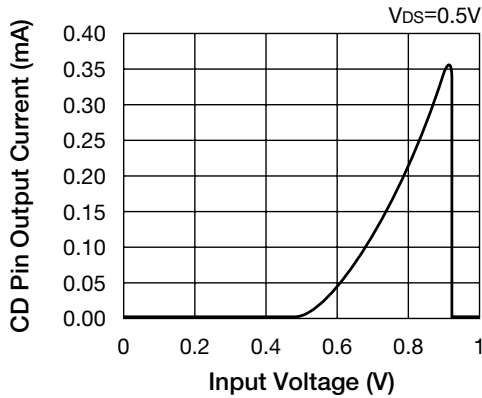

■ Delay time vs CD

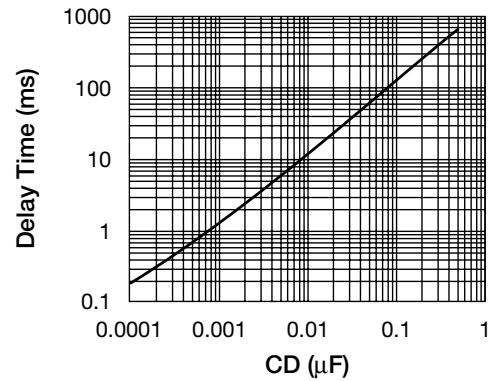

■ Detecting voltage vs temperature

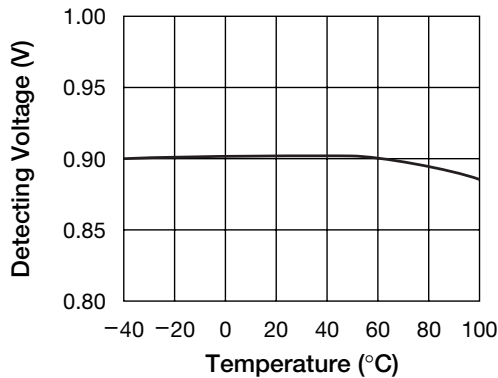

■ Hysteresis voltage vs temperature

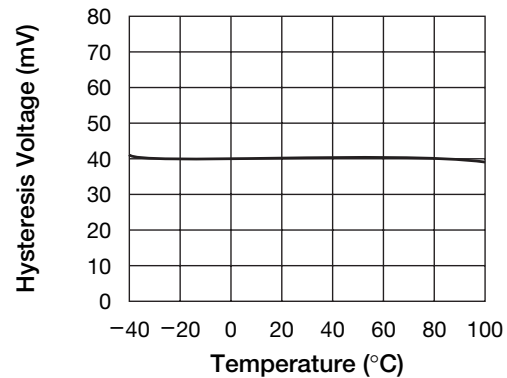

Note: These are typical characteristics.

■ Output current 1 vs temperature

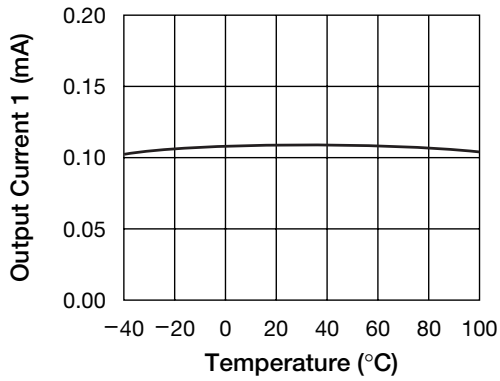

■ Output current 2 vs temperature

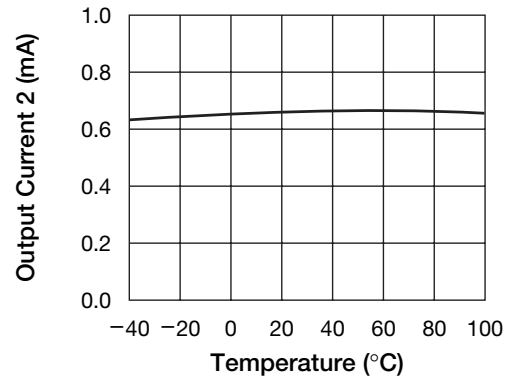

■ CD Pin threshold voltage vs temperature

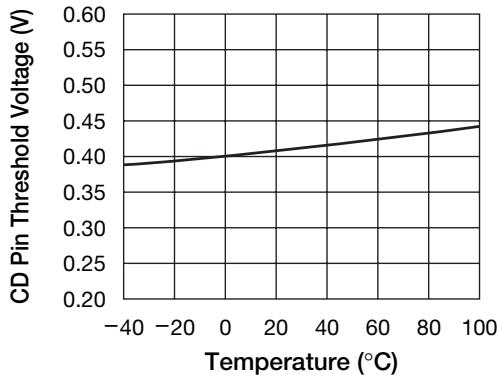

■ CD Pin output current 1 vs temperature

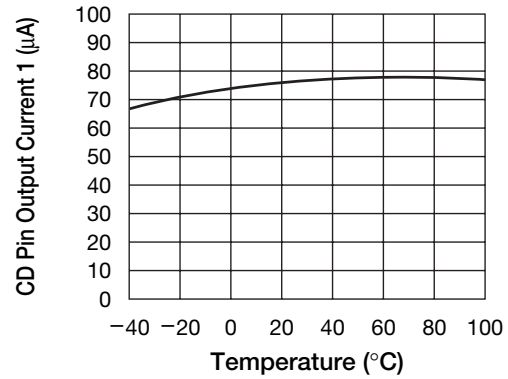

■ CD Pin output current 2 vs temperature

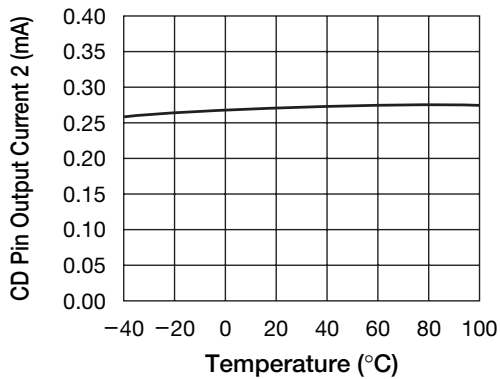

Note: These are typical characteristics.

Characteristics (For products with PST3628 detection voltage 2.8V typ. N-ch open drain)

■ Output voltage vs input voltage

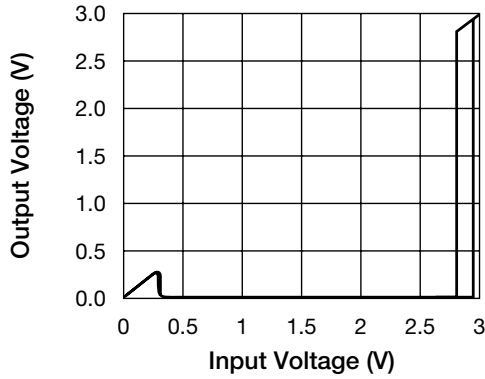

■ Consumption current vs input voltage

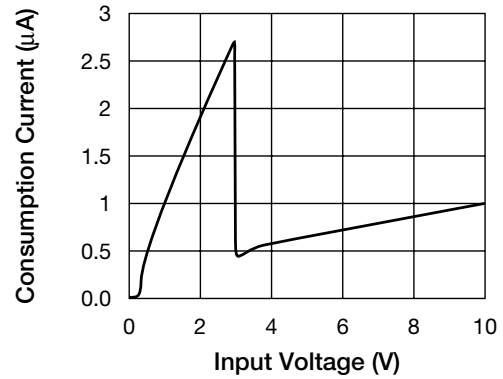

■ CD Pin output current vs input voltage

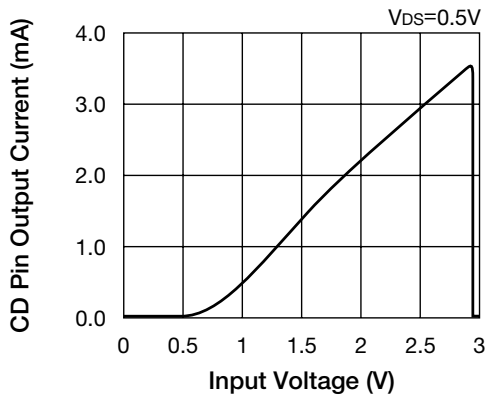

■ Delay time vs CD

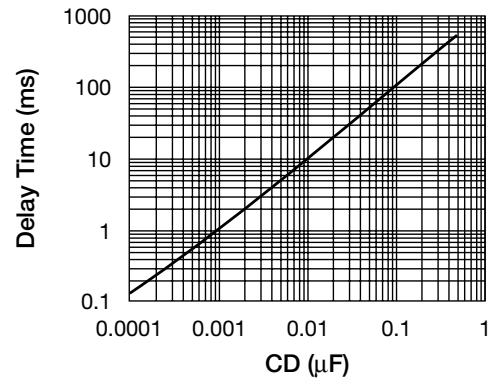

■ Detecting voltage vs temperature

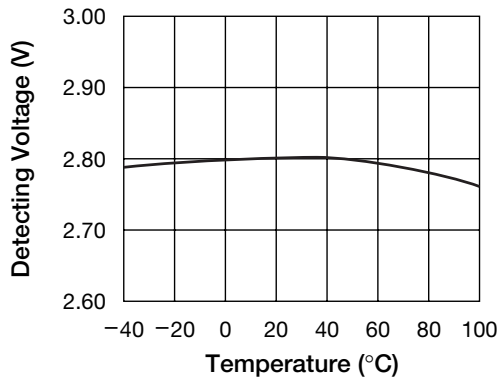

■ Hysteresis voltage vs temperature

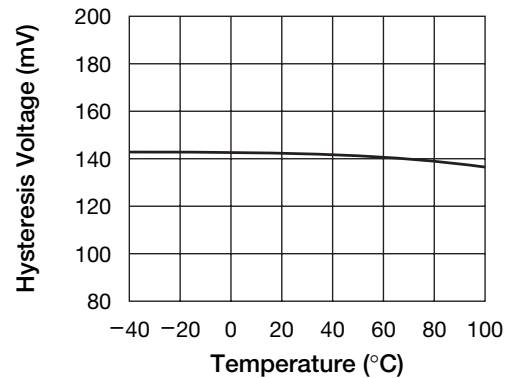

Note: These are typical characteristics.

■ Output current 1 vs temperature

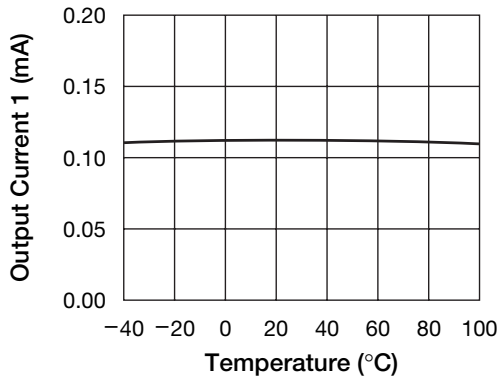

■ Output current 2 vs temperature

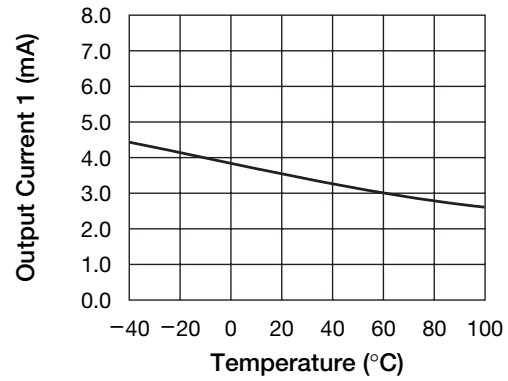

■ CD Pin threshold voltage vs temperature

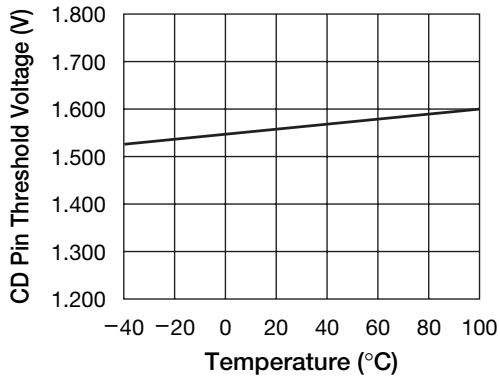

■ CD Pin output current 1 vs temperature

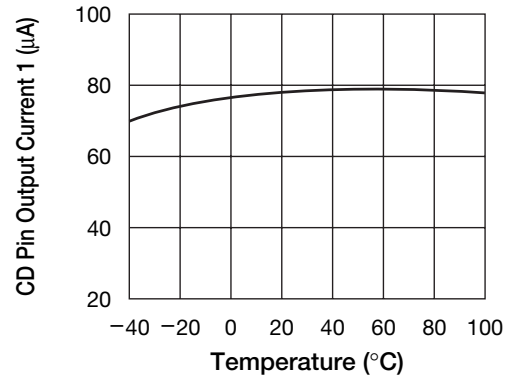

■ CD Pin output current 2 vs temperature

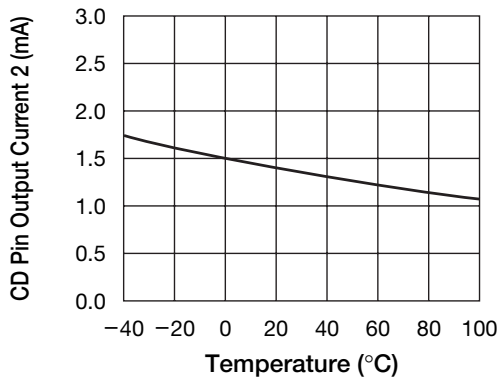

Note: These are typical characteristics.

Characteristics (For products with PST3646 detection voltage 4.6V typ. N-ch open drain)

■ Output voltage vs input voltage

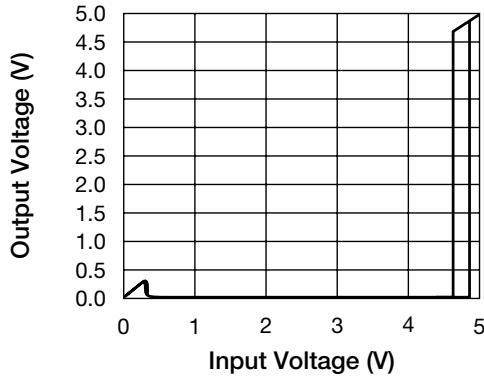

■ Consumption current vs input voltage

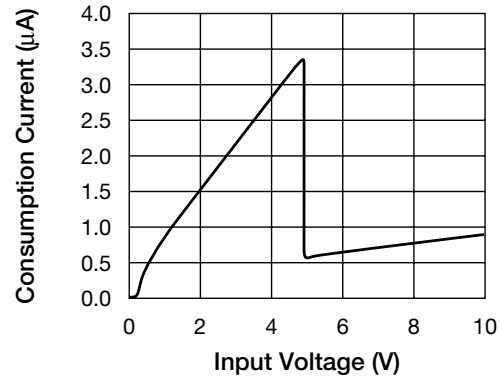

■ CD Pin output current vs input voltage

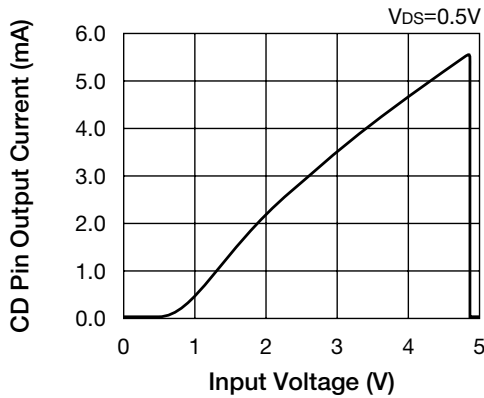

■ Delay time vs CD

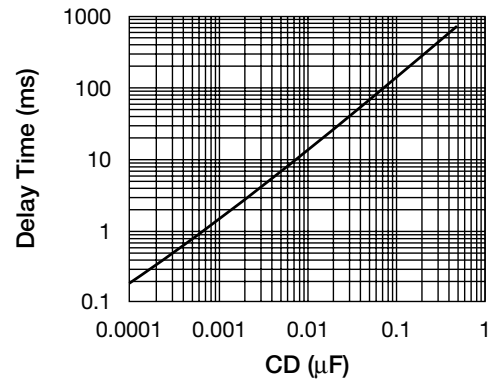

■ Detecting voltage vs temperature

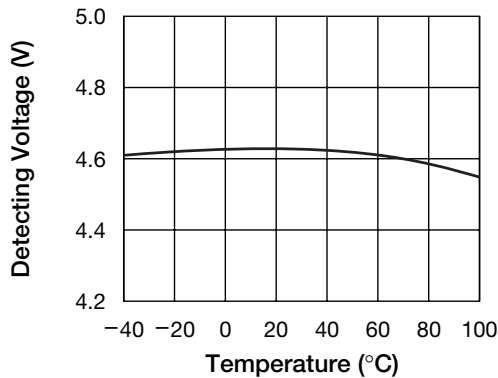

■ Hysteresis voltage vs temperature

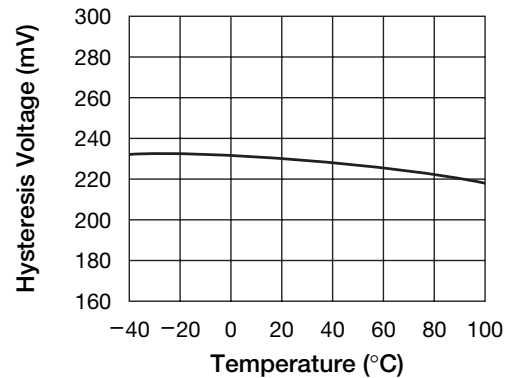

Note: These are typical characteristics.

■ Output current 1 vs temperature

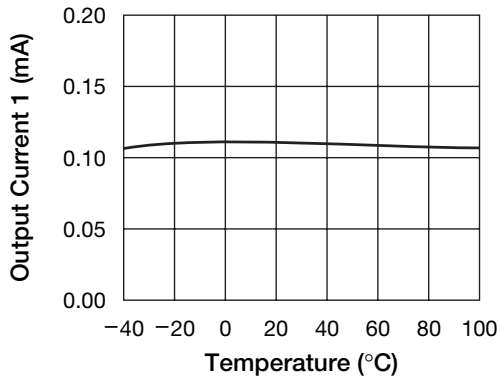

■ Output current 2 vs temperature

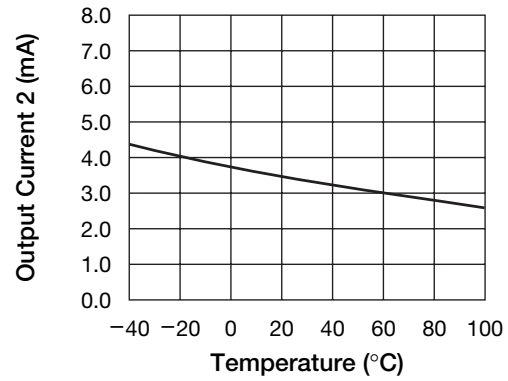

■ CD Pin threshold voltage vs temperature

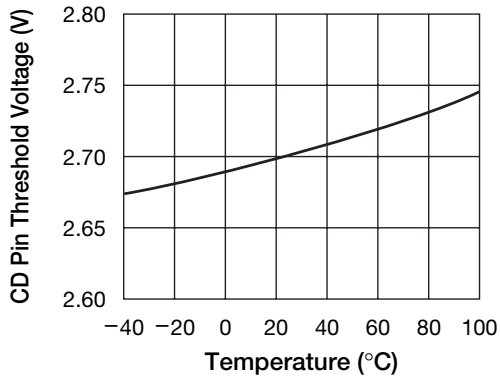

■ CD Pin output current 1 vs temperature

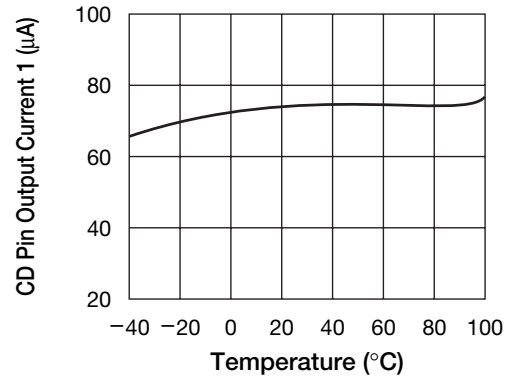

■ CD Pin output current 2 vs temperature

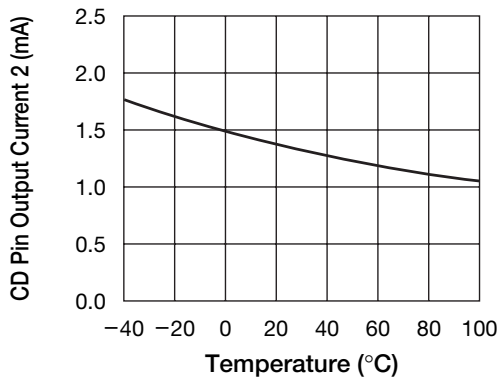

Note: These are typical characteristics.