



The Infinite Bandwidth Company™

# MIC2525

## USB Power Control Switch

Not Recommended for New Designs  
Refer to MIC2025

### General Description

The MIC2525 is an integrated high-side power switch, optimized for self-powered and bus-powered Universal Serial Bus (USB) applications. Few external components are necessary to satisfy USB requirements.

The MIC2525 satisfies the following USB requirements: each switch channel supplies up to 500mA as required by USB downstream devices; the switch's low on-resistance meets USB voltage drop requirements; fault current is limited to typically 750mA, well below the UL 25VA safety requirements; and a flag output is available to indicate fault conditions to the local USB controller. Soft start eliminates the momentary voltage drop on the upstream port that may occur when the switch is enabled in bus-powered applications.

Additional features include thermal shutdown to prevent catastrophic switch failure from high-current loads, undervoltage lockout (UVLO) to ensure that the device remains off unless there is a valid input voltage present, and 3.3V and 5V logic compatible enable inputs.

The MIC2525 is a UL recognized component and is available in active-high and active-low versions in 8-pin DIP and SOIC packages.

*For new designs, please see the MIC2025/2075.*

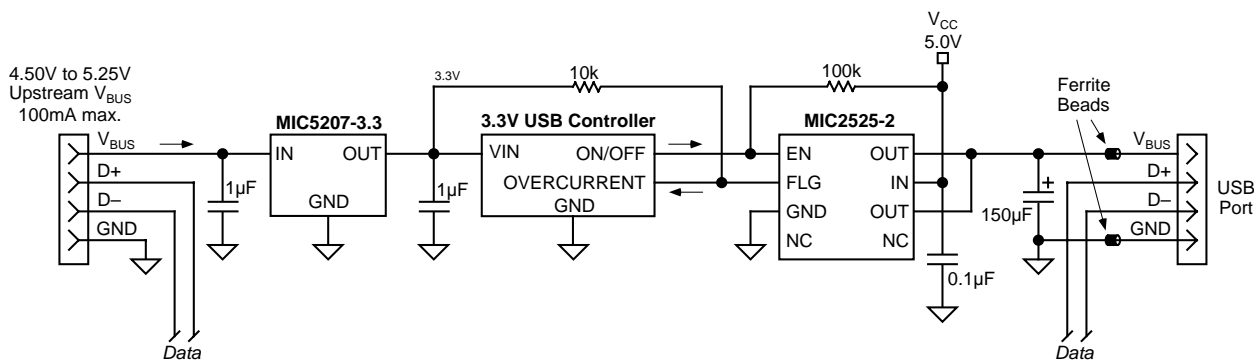
### Features

- Compliant to USB specifications
- UL Recognized Component
- 3V to 5.5V input
- 500mA minimum continuous load current per port
- 140mΩ maximum on-resistance
- 1.25A maximum short circuit current limit
- Open-drain fault flag pins
- 110µA typical on-state supply current
- 1µA typical off-state supply current
- Output can be forced higher than input (off-state)
- Thermal shutdown
- 2.4V typical undervoltage lockout (UVLO)
- 1ms turn-on (soft-start) and fast turnoff
- Active-high or active-low enable versions
- 8-pin SOIC and DIP packages

### Applications

- USB hosts and self-powered hubs
- USB bus-powered hubs
- Hot plug-in power supplies
- Battery-charger circuits

### Typical Application



Single-Port USB Self-Powered Hub



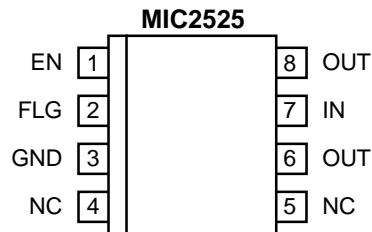
UL Recognized Component

Micrel, Inc. • 1849 Fortune Drive • San Jose, CA 95131 • USA • tel + 1 (408) 944-0800 • fax + 1 (408) 944-0970 • <http://www.micrel.com>

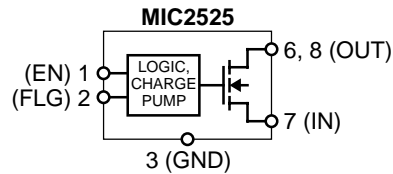
## Ordering Information

Part Number	Enable	Temperature Range	Package
MIC2525-1BM	Active High	-40°C to +85°C	8-Pin SOIC
MIC2525-2BM	Active Low	-40°C to +85°C	8-Pin SOIC
MIC2525-1BN	Active High	-40°C to +85°C	8-pin DIP
MIC2525-2BN	Active Low	-40°C to +85°C	8-pin DIP

## Pin Configuration



**8-Pin SOIC (M)**  
**8-Pin DIP (N)**



## Pin Description

Pin Number	Pin Name	Pin Function
1	EN	Enable (Input): Logic-compatible enable input. High input > 2.1V typical. Low input < 1.9V typical (-1 active high, -2 active low).
2	FLG	Fault Flag (Output): Active-low, open-drain output. Indicates overcurrent, UVLO and thermal shutdown.
3	GND	Ground: Supply return.
4, 5	NC	Not internally connected. (For pin compatibility with the MIC2505, connect pin 7 to pin 5 and leave pin 4 unconnected.)
7	IN	Supply Input: Output MOSFET drain. Also supplies IC's internal circuitry. Connect to positive supply.
6, 8	OUT	Switch Output: Output MOSFET source. Typically connect to switched side of load.

**Absolute Maximum Ratings (Note 1)**

Supply Voltage ( $V_{IN}$ )	+6V
Fault Flag Voltage ( $V_{FLG}$ )	+6V
Fault Flag Current ( $I_{FLG}$ )	50mA
Output Voltage ( $V_{OUT}$ )	+6V
Output Current ( $I_{OUT}$ )	Internally Limited
Control Input ( $V_{EN}$ )	-0.3V to 12V
Storage Temperature ( $T_S$ )	-65°C to +150°C
Lead Temperature (Soldering 5 sec.)	260°C
ESD Rating, <b>Note 3</b>	2kV

**Operating Ratings (Note 2)**

Supply Voltage ( $V_{IN}$ )	+3V to +5.5V
Ambient Operating Temperature ( $T_A$ )	-40°C to +85°C
Thermal Resistance	
SOIC ( $\theta_{JA}$ )	120°C/W
DIP( $\theta_{JA}$ )	130°C/W

**Electrical Characteristics**

$V_{IN} = +5V$ ;  $T_A = 25^\circ C$ ; unless noted.

Parameter	Condition	Min	Typ	Max	Units
Supply Current	<b>Note 4</b> , switch off, OUT = open		0.75	5	$\mu A$
	<b>Note 4</b> , switch on, OUT = open		110	160	$\mu A$
Enable Input Threshold	low-to-high transition		2.1	2.4	V
	high-to-low transition, <b>Note 4</b>	0.8	1.9		V
Enable Input Current	$V_{EN} = 0V$ to 5.5V	-1	$\pm 0.01$	1	$\mu A$
Enable Input Capacitance			1		pF
Switch Resistance	$V_{IN} = 5V$ , $I_{OUT} = 500mA$		100	140	m $\Omega$
	$V_{IN} = 3.3V$ , $I_{OUT} = 500mA$		140	180	m $\Omega$
Output Turn-On Delay	$R_L = 10\Omega$ each output		0.5		ms
Output Turn-On Rise Time	$R_L = 10\Omega$ each output		1		ms
Output Turnoff Delay	$R_L = 10\Omega$ each output		1	20	$\mu s$
Output Turnoff Fall Time	$R_L = 10\Omega$ each output		1	20	$\mu s$
Output Leakage Current	output disabled			10	$\mu A$
Continuous Load Current		0.5			A
Short-Circuit Current Limit	enable into load, $V_{OUT} = 4.0V$	0.5	0.75	1.25	A
Current-Limit Threshold	ramped load applied to enabled output, $V_{OUT} \leq 4.0V$ , <b>Note 5</b>		1.6	2.2	A
Overtemperature Shutdown Threshold	$T_J$ increasing		135		$^\circ C$
	$T_J$ decreasing		125		$^\circ C$
Error Flag Output Resistance	$V_{IN} = 5V$ , $I_L = 10mA$		10	25	$\Omega$
	$V_{IN} = 3.3V$ , $I_L = 10mA$		15	40	$\Omega$
Error Flag Off Current	$V_{FLAG} = 5V$		0.01	1	$\mu A$
UVLO Threshold	$V_{IN} =$ increasing		2.5		V
	$V_{IN} =$ decreasing		2.3		V

**Note 1.** Exceeding the absolute maximum rating may damage the device.

**Note 2.** The device is not guaranteed to function outside its operating rating.

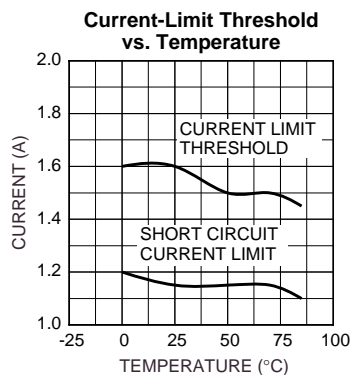
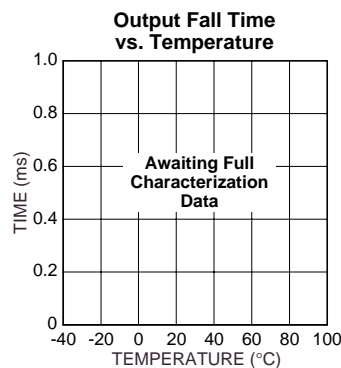
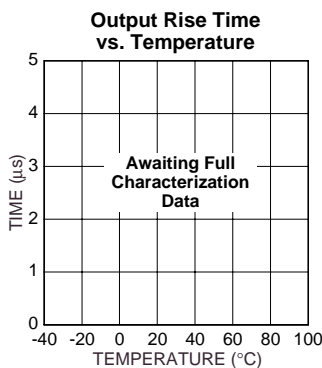
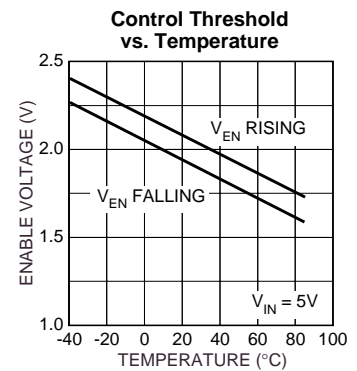
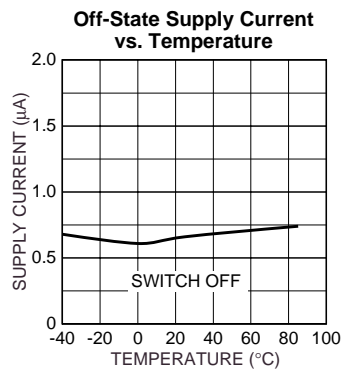
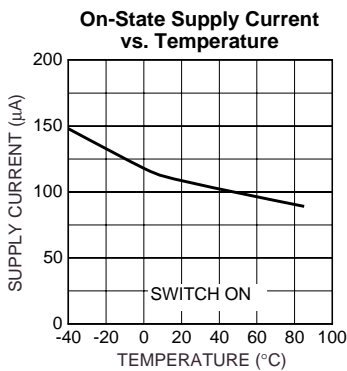
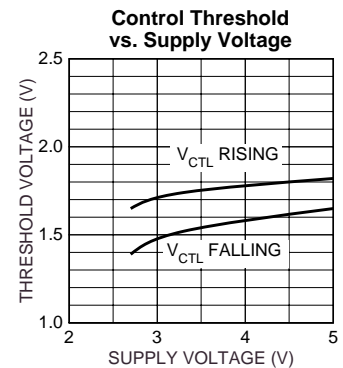
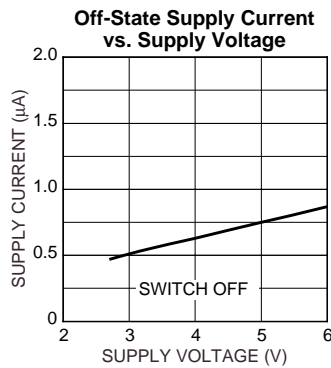
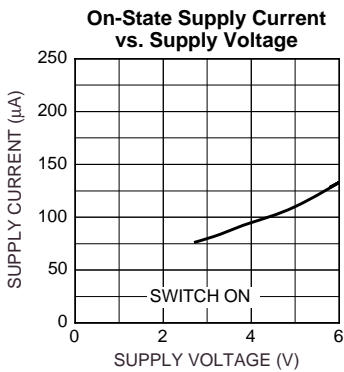
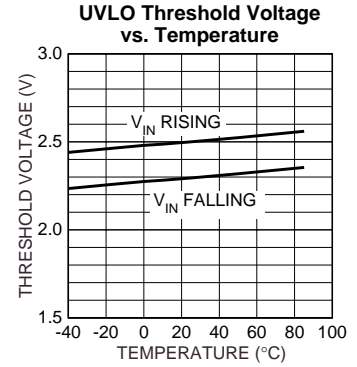
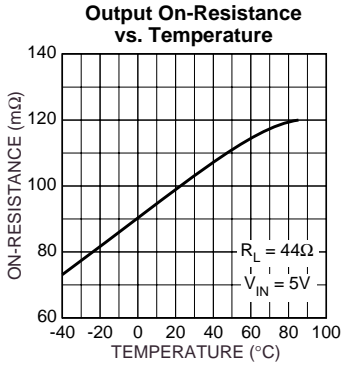
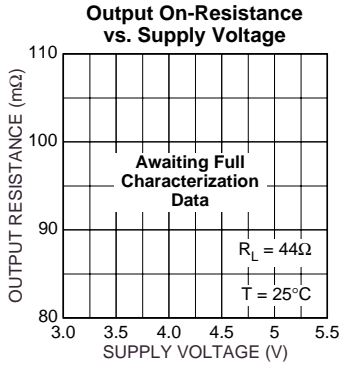
**Note 3.** Devices are ESD sensitive. Handling precautions recommended. Human body model, 1.5k in series with 100pF.

**Note 4.** Off is  $\leq 0.8V$  and on is  $\geq 2.4V$  for the MIC2525-1. Off is  $\geq 2.4V$  and on is  $\leq 0.8V$  for the MIC2525-2. The enable input has approximately 200mV of hysteresis. See control threshold charts.

**Note 5.** See "Functional Characteristics: Current-Limit Response" photo.

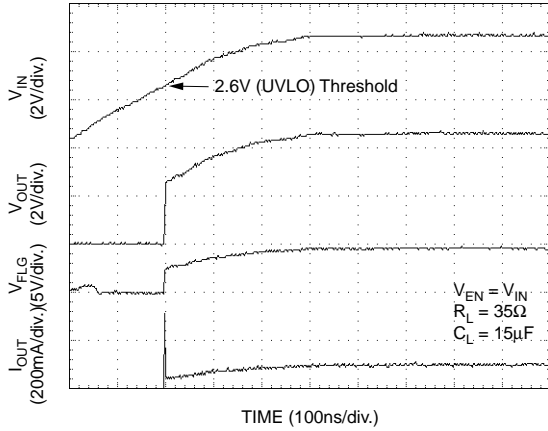
# Typical Characteristics

$V_{IN} = 5V$ ;  $T_A = 25^\circ C$ ; one switch section; unless noted.

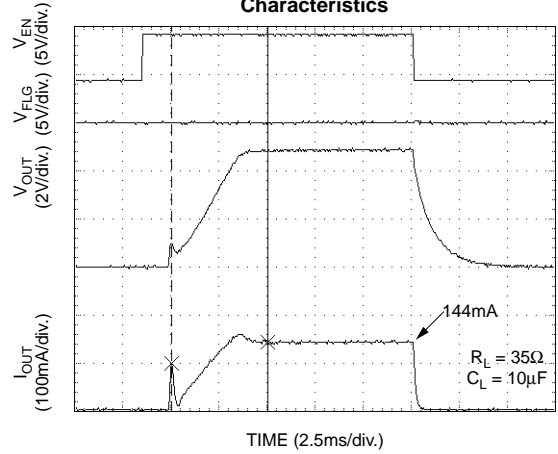


# Functional Characteristics

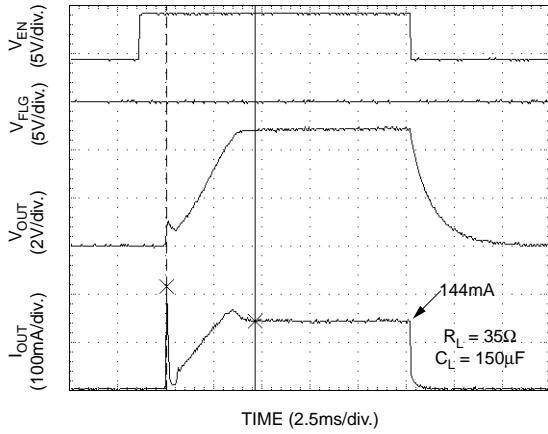
**Input Voltage Response**



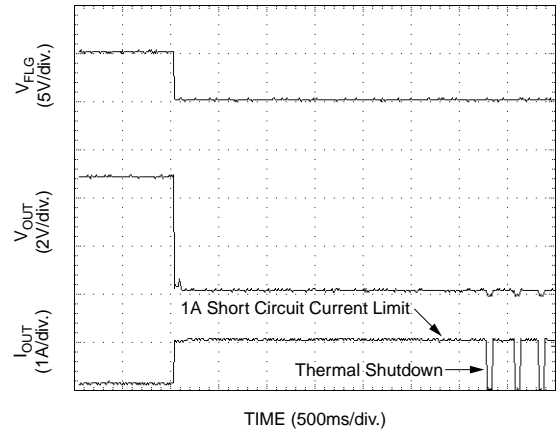
**Turn-On, Turnoff Characteristics**



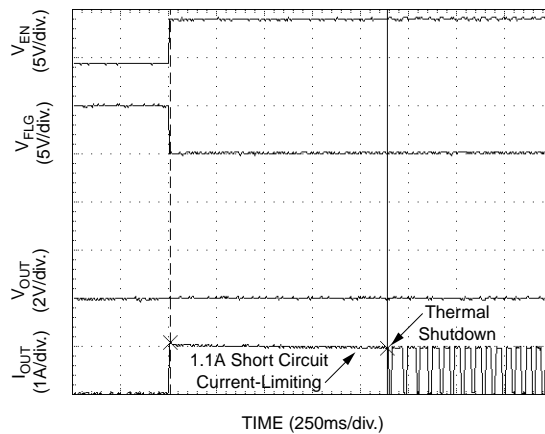
**Turn-On, Turnoff Characteristics**



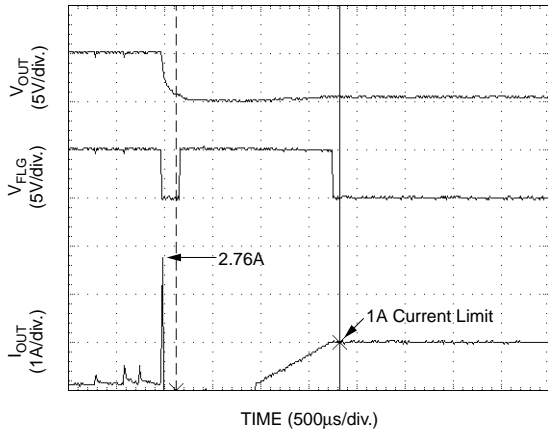
**Short Circuit Response (Short Applied to Output)**



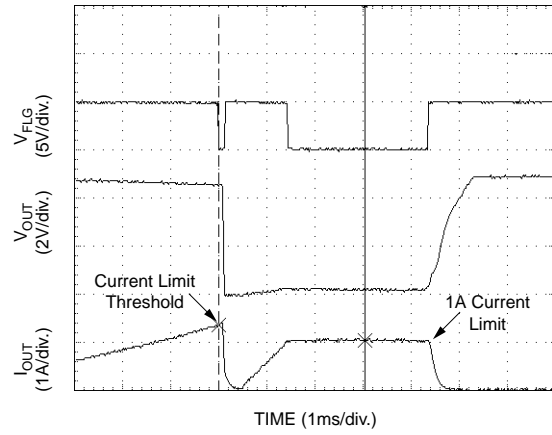
**Short Circuit Response Enable into Short Circuit**



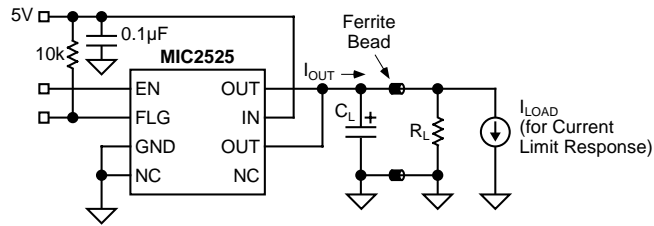
**Short Circuit Transient Response  
(Short Applied to Output)**



**Current-Limit Response  
(Ramped Load)**

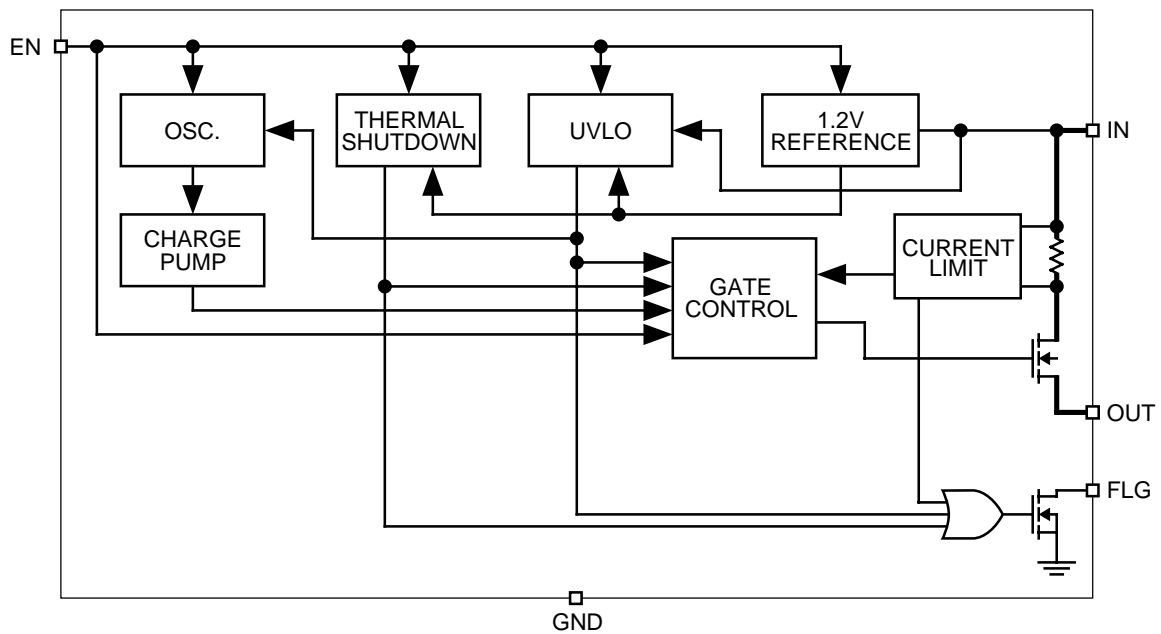


**Test Circuit**



**Functional Characteristics Test Circuit**

### Block Diagram



## Functional Description

The MIC2525-1 and MIC2525-2 are high-side switches with active-high and active-low enable inputs, respectively. Fault conditions turn off or inhibit turn-on of the output transistor, depending upon the type of fault, and activate the open-drain error flag transistor making it sink current to ground.

### Input and Output

IN (input) is the power supply connection to the logic circuitry and the drain of the output MOSFET. OUT (output) is the source of the output MOSFET. In a typical circuit, current flows through the switch from IN to OUT toward the load. If  $V_{OUT}$  is greater than  $V_{IN}$  when the switch is enabled, current will flow from OUT to IN since the MOSFET is bidirectional when on.

The output MOSFET and driver circuitry are also designed to allow the MOSFET source to be externally forced to a higher voltage than the drain ( $V_{OUT} > V_{IN}$ ) when the output is off. In this situation, the MIC2525 avoids undesirable current flow from OUT to IN. If  $V_{IN} < 2.5V$ , UVLO disables the switch.

### Thermal Shutdown

Thermal shutdown shuts off the output MOSFET and signals the fault flag if the die temperature exceeds 135°C. 10°C of hysteresis prevents the switch from turning on until the die temperature drops to 125°C. Overtemperature detection functions only when the switch is enabled.

### Current Limit Induced Thermal Shutdown

Internal circuitry increases the output MOSFET on-resistance until the series combination of the MOSFET on-resistance and the load impedance limit current to typically 750mA. The increase in power dissipation, in most cases, will cause the MIC2525 to go into thermal shutdown. When this is undesirable, thermal shutdown can be avoided by externally responding to the fault and disabling the current limited channel before the shutdown temperature is reached. The delay between the flag indication of a current limit fault and thermal shutdown will vary with ambient temperature, board layout, and load impedance, but is typically several hundred milliseconds. The USB controller must therefore recognize a fault and disable the switch within this time. If the fault is not removed or the switch is not disabled within this time, then the device will enter into a thermal oscillation of about 2Hz. This does not cause any damage to the device. Refer to “Functional Characteristics: Thermal Shutdown Response.”

### Undervoltage Lockout

UVLO (undervoltage lockout) prevents the output MOSFET from turning on until  $V_{IN}$  exceeds approximately 2.5V. In the undervoltage state, the FLAG will be low. After the switch turns on, if the voltage drops below approximately 2.3V, UVLO shuts off the output MOSFET and signals fault flag. Undervoltage detection functions only when the switch is enabled.

### Current Sensing and Limiting

The current-limit threshold is preset internally. The preset level prevents damage to the output MOSFET and external load but allows a minimum current of 0.5A through the output MOSFET.

The current-limit circuit senses a portion of the output FET switch current. The current sense resistor shown in the block diagram is virtual and has no voltage drop. The reaction to an overcurrent condition varies with three scenarios:

#### Switch Enabled into Short Circuit

If a switch is powered on or enabled into a heavy load or short-circuit, the switch immediately goes into a constant-current mode, reducing the output voltage. The fault flag goes low until the load is reduced. See the “Functional Characteristics: Short Circuit Response, Enabled into Short Circuit” photo.

#### Short Circuit Applied to Output

When a heavy load is applied, a large transient current may flow until the current limit circuitry responds. Once this occurs, the device limits current to less than the short-circuit current limit specification. See the “Short Circuit Transient Response, Short Applied to Output” graph.

#### Current-Limit Response

The MIC2525 current-limit profile exhibits a small foldback effect of approximately 500mA. Once this current-limit threshold is exceeded the device enters constant-current mode. This constant current is specified as the short circuit current limit in the “Electrical Characteristics” table. It is important to note that the MIC2525 will deliver load current up to the current-limit threshold which is typically 1.6A. Refer to “Functional Characteristics: Current-Limit Response” photo for details.

#### Fault Flag

FLG is an N-channel, open-drain MOSFET output. The fault-flag is active (low) for one or more of the following conditions: undervoltage (while  $2V < V_{IN} < 2.7$ ), current limit, or thermal shutdown. The flag output MOSFET is capable of sinking a 10mA load to typically 100mV above ground.



## Applications Information

### Supply Filtering

A 0.1µF to 1µF bypass capacitor from IN to GND, located at the device, is strongly recommended to control supply transients. Without a bypass capacitor, an output short may cause sufficient ringing on the input (from supply lead inductance) to damage internal control circuitry.

*Input or output transients must not exceed the absolute maximum supply voltage ( $V_{IN\ max} = 6V$ ) even for a short duration.*

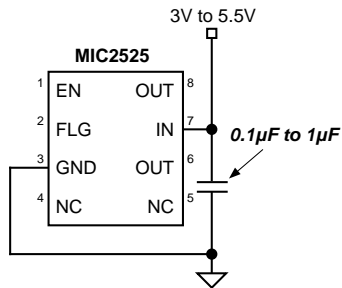


Figure 1. Supply Bypassing

### Enable Input

EN must be driven logic high or logic low for a clearly defined input. Floating the input may cause unpredictable operation. EN should not be allowed to go negative with respect to GND.

### Soft Start

The MIC2525 presents a high impedance when off, and slowly becomes a low impedance as it turns on. This reduces inrush current and related voltage drop that results from charging a capacitive load, satisfying the USB voltage droop requirements for bus-powered applications as shown in Figure 2.

The soft start circuit shown in Figure 3 can be utilized to meet USB transient regulation specifications with large load capacitances ( $C_{BULK} > 10\mu F$ ). The MIC2525 will provide inrush current limiting for these applications.

### Transient Overcurrent Filter

When the MIC2525 is enabled, large values of capacitance at the output of the device will cause inrush current to exceed the short circuit current-limit threshold of the device and assert the flag. The duration of this time will depend on the size of the output capacitance. Refer to the "Functional Characteristics" turn-on and turnoff behaviors for details.

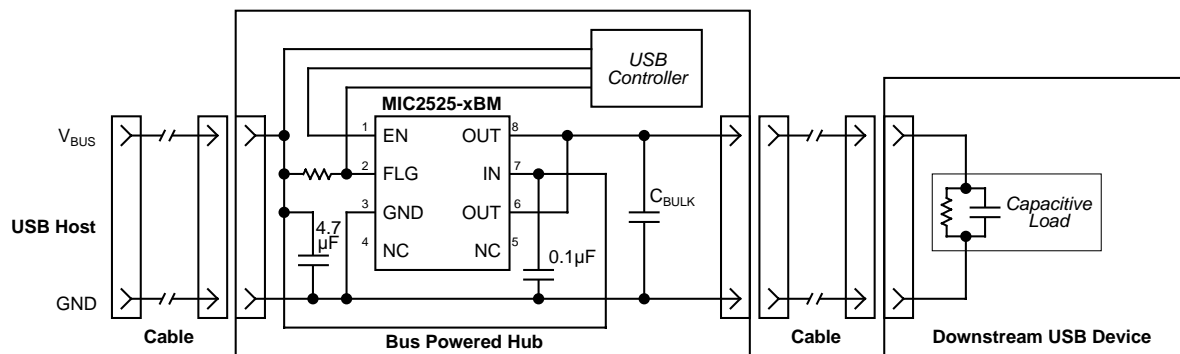


Figure 2. Soft-Start Application

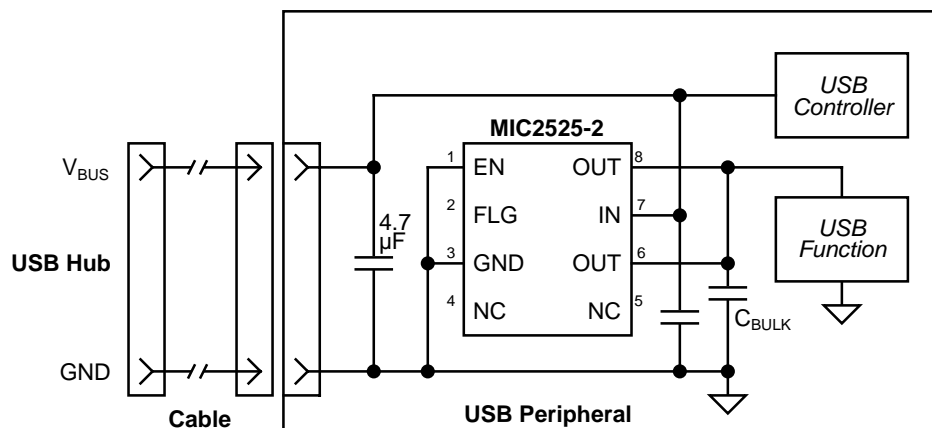
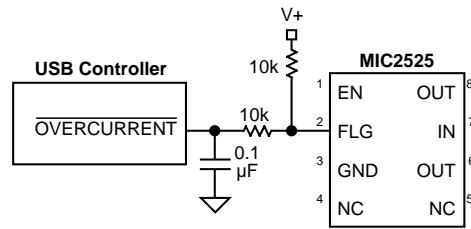


Figure 3. Inrush Current-Limit Application

During the capacitance charging time, the device enters into constant-current mode. As the capacitance is charged, the current decreases below the short circuit current-limit threshold, and the flag will then be deasserted.

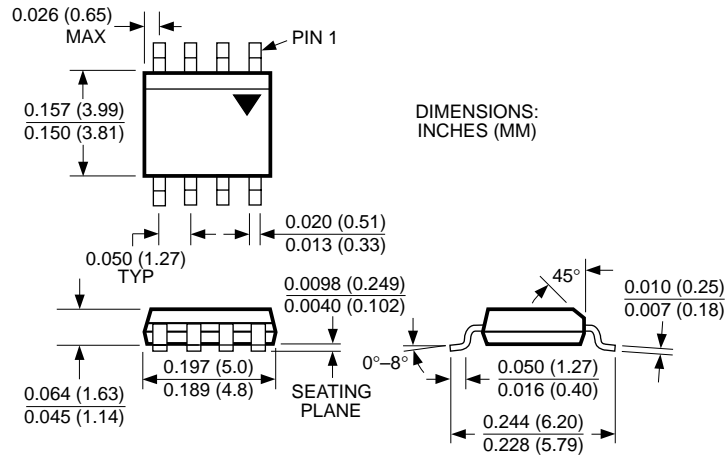
In USB applications, it is required that output bulk capacitance is utilized to support hot-plug events. When the MIC2525 is enabled, the flag may go active for about 1ms due to inrush current exceeding the current-limit setpoint. Additionally, during hot-plug events, inrush currents may also cause the flag to go active for 30 $\mu$ s. Since these conditions are not valid overcurrent faults, the USB controller must ignore the flag during these events. To prevent this erroneous overcurrent reporting, a 1ms RC filter as shown in Figure 4 may be used.

Alternatively, a 1ms debounce routine may be programmed into the USB logic controller, eliminating the need for the RC filter.

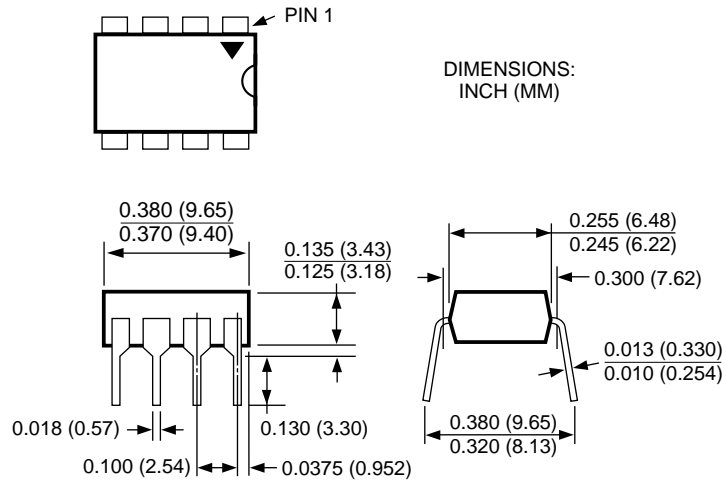


**Figure 4. Transient Filter**

Package Information



8-Pin SOP (M)



8-Pin Plastic DIP (N)

---

**MICREL INC. 1849 FORTUNE DRIVE SAN JOSE, CA 95131 USA**

TEL + 1 (408) 944-0800 FAX + 1 (408) 944-0970 WEB <http://www.micrel.com>

This information is believed to be accurate and reliable, however no responsibility is assumed by Micrel for its use nor for any infringement of patents or other rights of third parties resulting from its use. No license is granted by implication or otherwise under any patent or patent right of Micrel Inc.

© 2000 Micrel Incorporated