



5V/3.3V 32K X 8 CMOS SRAM (Common I/O)

Features

- AS7C256 (5V version)
- AS7C3256 (3.3V version)
- Industrial and commercial temperature
- Organization: 262,144 words × 16 bits
- High speed
 - 12/15/20 ns address access time
 - 5/6/7/9 ns output enable access time
- Very low power consumption: ACTIVE
 - 660mW (AS7C256) / max @ 12 ns
 - 216mW (AS7C3256) / max @ 12 ns
- Very low power consumption: STANDBY
 - 22 mW (AS7C256) / max CMOS I/O
 - 7.2 mW (AS7C3256) / max CMOS I/O
- 2.0V data retention
- Easy memory expansion with \overline{CE} and \overline{OE} inputs
- TTL-compatible, three-state I/O
- 28-pin JEDEC standard packages
 - 300 mil PDIP
 - 300 mil SOJ
 - 8 × 13.4 TSOP
- ESD protection ≥ 2000 volts
- Latch-up current ≥ 200 mA

Logic block diagram

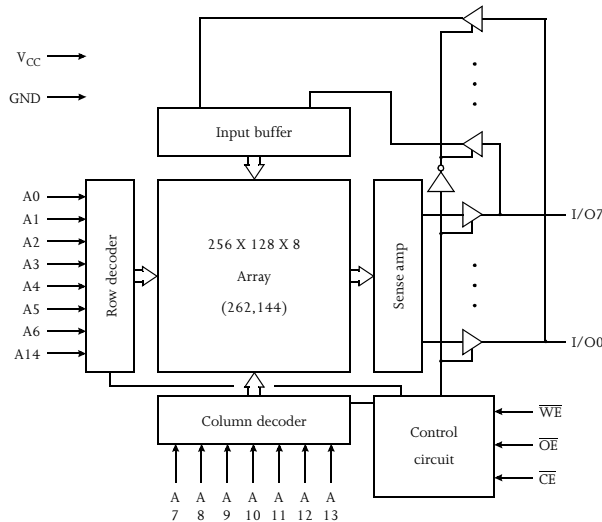

Pin arrangement

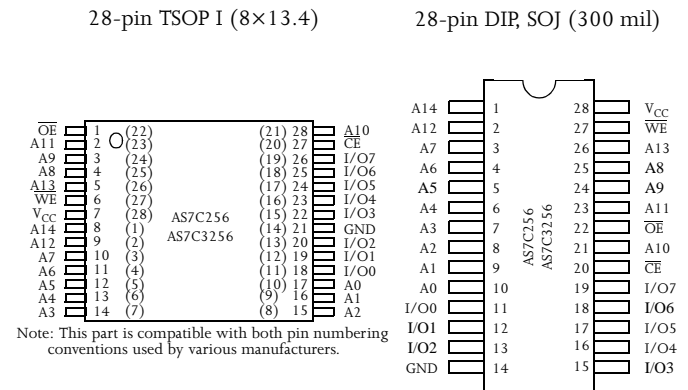

Selection guide

	AS7C256-10 AS7C3256-10	AS7C256-12 AS7C3256-12	AS7C256-15 AS7C3256-15	AS7C256-20 AS7C3256-20	Unit
Maximum address access time	10	12	15	20	ns
Maximum output enable access time		5	6	7	ns
Maximum operating current	AS7C256	120	115	110	mA
	AS7C3256	60	55	50	mA
Maximum CMOS standby current	AS7C256	4	4	4	mA
	AS7C3256	2	2	2	mA



Functional description

The AS7C(3)256 is a 5V/3.3V high-performance CMOS 262,144-bit Static Random-Access Memory (SRAM) device organized as 262,144 words \times 16 bits. It is designed for memory applications requiring fast data access at low voltage, including Pentium™, PowerPC™, and portable computing. Alliance's advanced circuit design and process techniques permit 3.3V operation without sacrificing performance or operating margins.

The device enters standby mode when \overline{CE} is high. CMOS standby mode consumes ≤ 3.6 mW. Normal operation offers 75% power reduction after initial access, resulting in significant power savings during CPU idle, suspend, and stretch mode. Both versions of the AS7C256 offer 2.0V data retention.

Equal address access and cycle times (t_{AA} , t_{RC} , t_{WC}) of 12/15/20 ns with output enable access times (t_{OE}) of 5/6/7/9 ns are ideal for high-performance applications. The chip enable (\overline{CE}) input permits easy memory expansion with multiple-bank memory organizations.

A write cycle is accomplished by asserting chip enable (\overline{CE}) and write enable (\overline{WE}) LOW. Data on the input pins I/O0-I/O7 is written on the rising edge of \overline{WE} (write cycle 1) or \overline{CE} (write cycle 2). To avoid bus contention, external devices should drive I/O pins only after outputs have been disabled with output enable (\overline{OE}) or write enable (\overline{WE}).

A read cycle is accomplished by asserting chip enable (\overline{CE}) and output enable (\overline{OE}) LOW, with write enable (\overline{WE}) high. The chip drives I/O pins with the data word referenced by the input address. When chip enable or output enable is high, or write enable is low, output drivers stay in high-impedance mode.

All chip inputs and outputs are TTL-compatible and 5V tolerant. Operation is from a single 3.3 ± 0.3 V supply. The AS7C(3)256A is packaged in high volume industry standard packages.

Absolute maximum ratings

Parameter	Device	Symbol	Min	Max	Unit
Voltage on V_{CC} relative to GND	AS7C256	V_{t1}	-0.5	+7.0	V
	AS7C3256	V_{t1}	-0.5	+5.0	V
Voltage on any pin relative to GND		V_{t2}	-0.5	$V_{CC} + 0.5$	V
Power dissipation		P_D	-	1.0	W
Storage temperature (plastic)		T_{stg}	-65	+150	°C
Ambient temperature with V_{CC} applied		T_{bias}	-55	+125	°C
DC current into outputs (low)		I_{OUT}	-	20	mA

Stresses greater than those listed under Absolute Maximum Ratings may cause permanent damage to the device. This is a stress rating only and functional operation of the device at these or any other conditions outside those indicated in the operational sections of this specification is not implied. Exposure to absolute maximum rating conditions for extended periods may affect reliability.

Truth table

\overline{CE}	\overline{WE}	\overline{OE}	Data	Mode
H	X	X	High Z	Standby (I_{SB} , I_{SB1})
L	H	H	High Z	Output disable (I_{CC})
L	H	L	D_{OUT}	Read (I_{CC})
L	L	X	D_{IN}	Write (I_{CC})

Key: X = Don't care, L = Low, H = High



Recommended operating conditions

Parameter	Device	Symbol	Min	Typical	Max	Unit
Supply voltage	AS7C256	V_{CC}	4.5	5.0	5.5	V
	AS7C3256	V_{CC}	3.0	3.3	3.6	V
Input voltage	AS7C256	V_{IH}	2.2	—	$V_{CC}+0.5$	V
	AS7C3256	V_{IH}	2.0	—	$V_{CC}+0.5$	V
	—	V_{IL}^*	-0.5*	—	0.8	V
Ambient operating temperature	commercial	T_A	0	—	70	°C
	industrial	T_A	-40	—	85	°C

* V_{IL} min = -2.0V for pulse width less than $t_{RC}/2$.

DC operating characteristics (over the operating range)¹

Parameter	Sym	Test conditions	Device	-10		-12		-15		-20		Unit
				Min	Max	Min	Max	Min	Max	Min	Max	
Input leakage current	$ I_{Ll} $	$V_{CC} = \text{Max}, V_{in} = \text{GND to } V_{CC}$				—	1	—	1	—	1	μA
Output leakage current	$ I_{LOl} $	$V_{CC} = \text{Max}, V_{OUT} = \text{GND to } V_{CC}$				—	1	—	1	—	1	μA
Operating power supply current	I_{CC}	$V_{CC} = \text{Max}, \overline{CE} \leq V_{IL}, f = f_{Max}, I_{OUT} = 0\text{mA}$	AS7C256			—	120	—	115	—	110	mA
			AS7C3256			—	60	—	55	—	50	
Standby power supply current	I_{SB}	$V_{CC} = \text{Max}, \overline{CE} \leq V_{IL}, f = f_{Max}, I_{OUT} = 0\text{mA}$	AS7C256			—	40	—	35	—	30	mA
			AS7C3256			—	20	—	20	—	20	
	I_{SB1}	$V_{CC} = \text{Max}, \overline{CE} \geq V_{CC}-0.2\text{V}, V_{IN} \leq \text{GND} + 0.2\text{V}$ or $V_{IN} \geq V_{CC}-0.2\text{V}, f = 0$	AS7C256			—	4.0	—	4.0	—	4.0	mA
			AS7C3256			—	2.0	—	2.0	—	2.0	
Output voltage	V_{OL}	$I_{OL} = 8\text{ mA}, V_{CC} = \text{Min}$				—	0.4	—	0.4	—	0.4	V
	V_{OH}	$I_{OH} = -4\text{ mA}, V_{CC} = \text{Min}$				2.4	—	2.4	—	2.4	—	V

Capacitance ($f = 1\text{MHz}, T_a = \text{room temperature}, V_{CC} = \text{NOMINAL}$)²

Parameter	Symbol	Signals	Test conditions	Max	Unit
Input capacitance	C_{IN}	A, \overline{CE} , \overline{WE} , \overline{OE}	$V_{in} = 0\text{V}$	5	pF
I/O capacitance	$C_{I/O}$	I/O	$V_{in} = V_{out} = 0\text{V}$	7	pF



Read cycle (over the operating range)^{3,9}

Parameter	Symbol	-10		-12		-15		-20		Unit	Notes
		Min	Max	Min	Max	Min	Max	Min	Max		
Read cycle time	t_{RC}			12	–	15	–	20	–	ns	
Address access time	t_{AA}			–	12	–	15	–	20	ns	3
Chip enable (\overline{CE}) access time	t_{ACE}			–	12	–	15	–	20	ns	3
Output enable (\overline{OE}) access time	t_{OE}			–	5	–	6	–	7	ns	
Output hold from address change	t_{OH}			3	–	3	–	3	–	ns	5
\overline{CE} LOW to output in low Z	t_{CLZ}			3	–	3	–	3	–	ns	4, 5
\overline{CE} HIGH to output in high Z	t_{CHZ}			–	3	–	4	–	5	ns	4, 5
\overline{OE} LOW to output in low Z	t_{OLZ}			0	–	0	–	0	–	ns	4, 5
\overline{OE} HIGH to output in high Z	t_{OHZ}			–	3	–	4	–	5	ns	4, 5
Power up time	t_{PU}			0	–	0	–	0	–	ns	4, 5
Power down time	t_{PD}			–	12	–	15	–	20	ns	4, 5

Key to switching waveforms

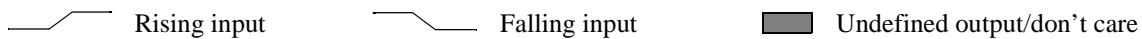

Read waveform 1 (address controlled)^{3,6,7,9}

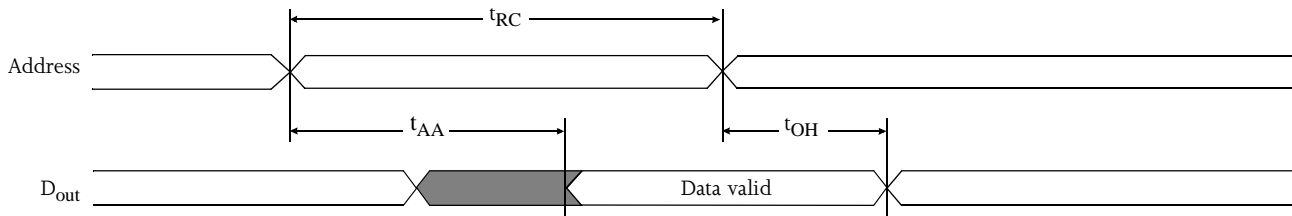

Read waveform 2 (\overline{CE} controlled)^{3,6,8,9}

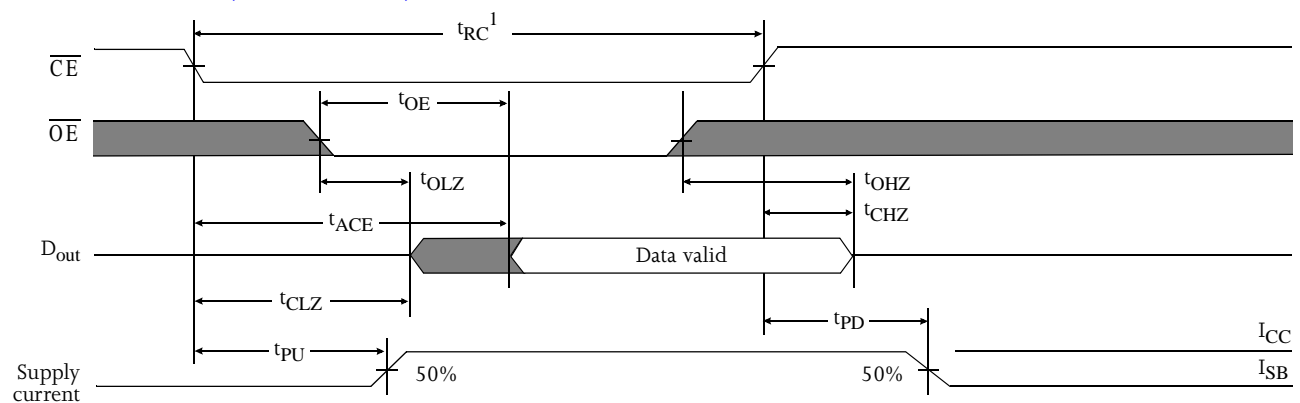



Data retention characteristics (over the operating range)¹³

Parameter	Symbol	Test conditions	Min	Max	Unit
V _{CC} for data retention	V _{DR}	V _{CC} = 2.0V $\overline{CE} \geq V_{CC} - 0.2V$ V _{IN} ≥ V _{CC} - 0.2V or V _{IN} ≤ 0.2V	2.0	–	V
Data retention current	I _{CCDR}		–	500	μA
Chip enable to data retention time	t _{CDR}		0	–	ns
Operation recovery time	t _R		t _{RC}	–	ns
Input leakage current	I _{LI}		–	1	μA

Data retention waveform

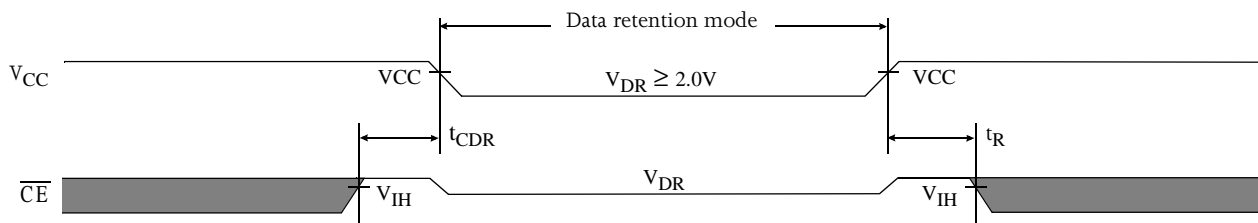

AC test conditions

- Output load: see Figure B or Figure C.
- Input pulse level: GND to 3.0V. See Figure A.
- Input rise and fall times: 2 ns. See Figure A.
- Input and output timing reference levels: 1.5V.

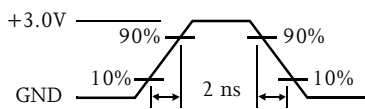

Figure A: Input pulse

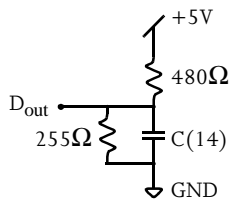

Figure B: Output load

Thevenin equivalent

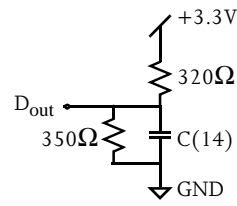
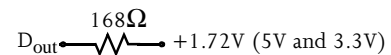

Figure C: Output load

Notes

- 1 During V_{CC} power-up, a pull-up resistor to V_{CC} on \overline{CE} is required to meet I_{SB} specification.
- 2 This parameter is sampled, but not 100% tested.
- 3 For test conditions, see AC Test Conditions, Figures A, B, C.
- 4 These parameters are specified with CL = 5pF, as in Figures B or C. Transition is measured ±500mV from steady-state voltage.
- 5 This parameter is guaranteed, but not tested.
- 6 \overline{WE} is High for read cycle.
- 7 \overline{CE} and \overline{OE} are Low for read cycle.
- 8 Address valid prior to or coincident with \overline{CE} transition Low.
- 9 All read cycle timings are referenced from the last valid address to the first transitioning address.
- 10 \overline{CE} or \overline{WE} must be High during address transitions. Either \overline{CE} or \overline{WE} asserting high terminates a write cycle.
- 11 All write cycle timings are referenced from the last valid address to the first transitioning address.
- 12 $\overline{CE1}$ and CE2 have identical timing.
- 13 2V data retention applies to the commercial operating range only.
- 14 C=30pF, except on High Z and Low Z parameters, where C=5pF.



Typical DC and AC characteristics

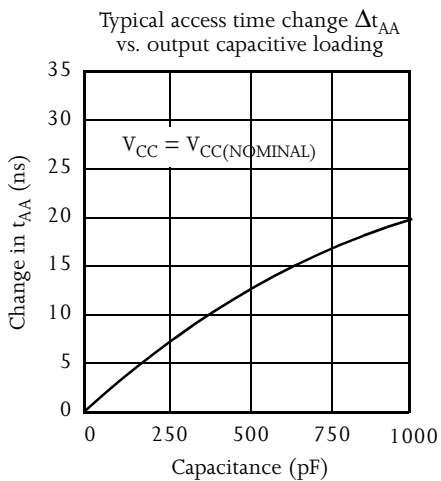
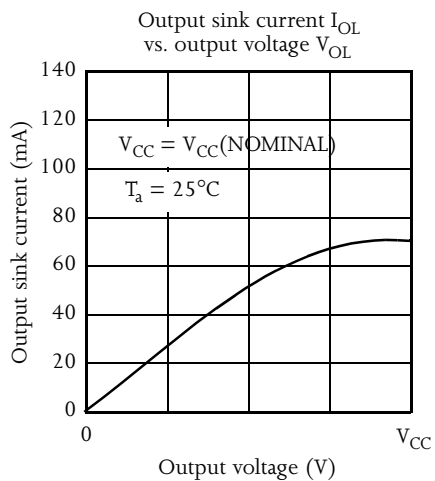
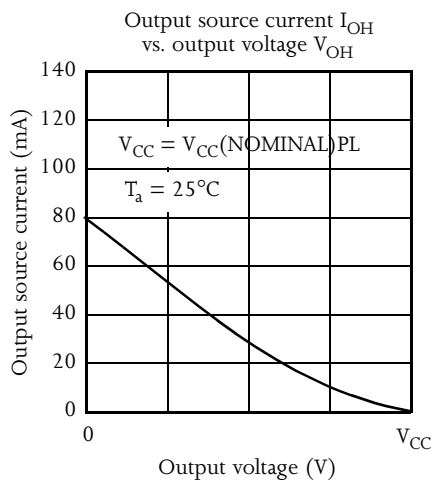
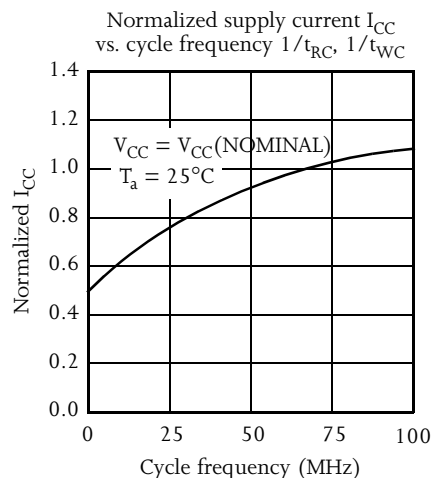
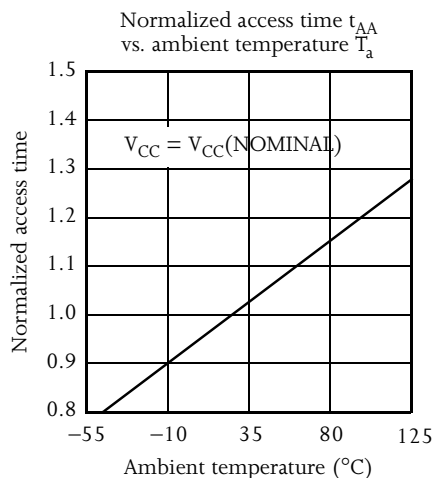
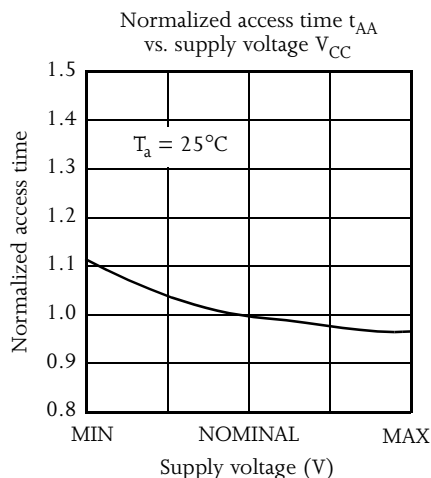
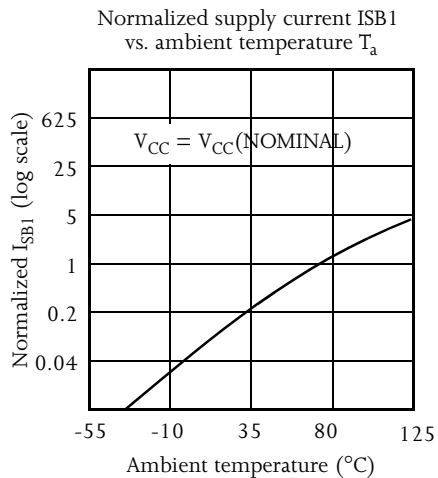
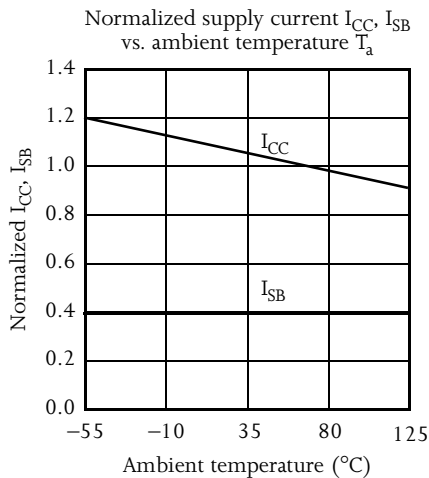
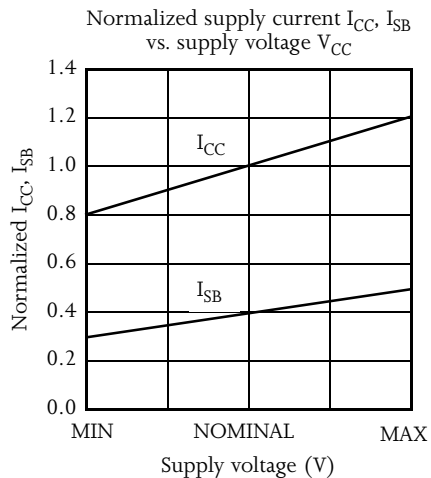



Package diagrams

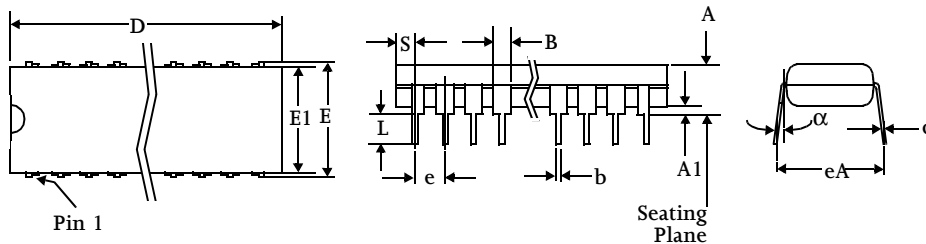

	28-pin PDIP	
	Min	Max
A	-	0.175
A1	0.010	-
B	0.058	0.064
b	0.016	0.022
c	0.008	0.014
D	-	1.400
E	0.295	0.320
E1	0.278	0.298
e	0.100 BSC	
eA	0.330	0.370
L	0.120	0.140
α	0°	15°
S	-	0.055

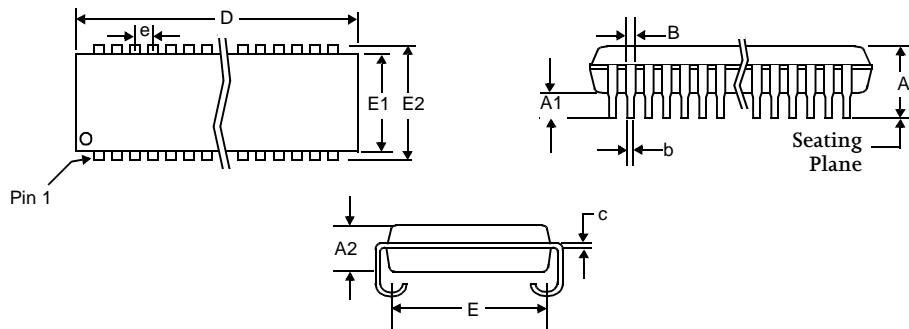

	28-pin SOJ	
	Min	Max
A	-	0.140
A1	0.025	-
A2	0.095	0.105
B	0.028 TYP	
b	0.018 TYP	
c	0.010 TYP	
D	-	0.730
E	0.245	0.285
E1	0.295	0.305
E2	0.327	0.347
e	0.050 BSC	

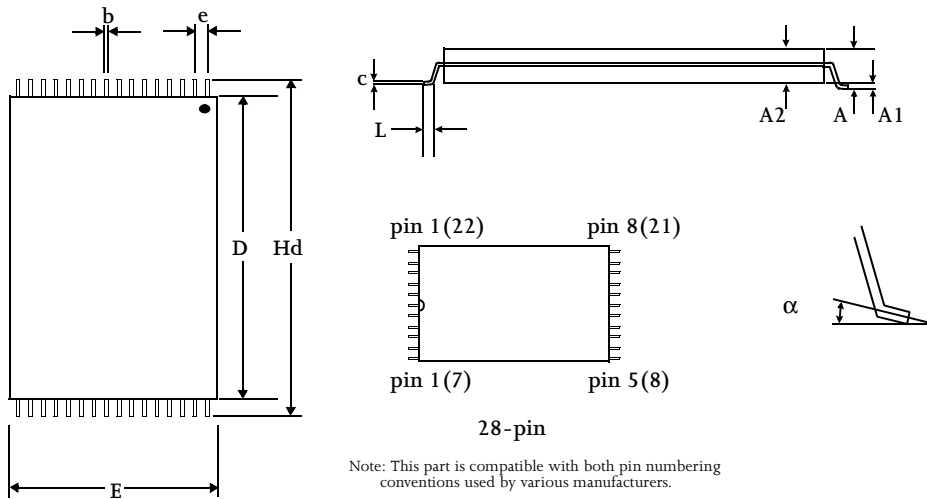

	28-pin 8x13.4	
	Min	Max
A	-	1.20
A1	0.10	0.20
A2	0.95	1.05
b	0.15	0.25
c	0.10	0.20
D	11.60	11.80
e	0.55 nominal	



Ordering information

Package / Access time	Volt/Temp	10 ns	12 ns	15 ns	20 ns
Plastic DIP, 300 mil	5V commercial	AS7C256-10PC	AS7C256-12PC	AS7C256-15PC	AS7C256-20PC
	3.3V commercial	AS7C3256-10PC	AS7C3256-12PC	AS7C3256-15PC	AS7C3256-20PC
Plastic SOJ, 300 mil	5V commercial	AS7C256-10JC	AS7C256-12JC	AS7C256-15JC	AS7C256-20JC
	3.3V commercial	AS7C3256-10JC	AS7C3256-12JC	AS7C3256-15JC	AS7C3256-20JC
	5V industrial	AS7C256-10JI	AS7C256-12JI	AS7C256-15JI	AS7C256-20JI
	3.3V industrial	AS7C3256-10JI	AS7C3256-12JI	AS7C3256-15JI	AS7C3256-20JI
TSOP 8x13.4	5V commercial	AS7C256-10TC	AS7C256-12TC	AS7C256-15TC	AS7C256-20TC
	3.3V commercial	AS7C3256-10TC	AS7C3256-12TC	AS7C3256-15TC	AS7C3256-20TC
	5V industrial	AS7C256-10TI	AS7C256-12TI	AS7C256-15TI	AS7C256-20TI
	3.3V industrial	AS7C3256-10TI	AS7C3256-12TI	AS7C3256-15TI	AS7C3256-20TI

Part numbering system

AS7C	3	256	-XX	X	C or I
SRAM prefix	3 = 3.3V supply	Device number	Access time	Package: J = SOJ 300 mil T = TSOP 8x13.4	Commercial temperature range: 0 °C to 70 °C Industrial temperature range: -40C to 85C