

N-CHANNEL POWER MOS FET ARRAY FOR SWITCHING

μPA1550 is a N-channel vertical power MOS FET and this switching device is available for direct drive by output of 5 V power supply IC.

This device features low on-resistance and excellent switching characteristic, and is ideal for control of devices such as mortars, solenoid, or ramp.

FEATURES

- Gate drive available at logic level ($V_{GS} = 4\text{ V}$)
- High current capacity and low on-resistance
 $I_{D(\text{pulse})} = \pm 20\text{ A}$
 $R_{DS(\text{on})} = 0.09\ \Omega\ \text{TYP. @ } V_{GS} = 10\text{ V}$
 $R_{DS(\text{on})} = 0.11\ \Omega\ \text{TYP. @ } V_{GS} = 4\text{ V}$
- Easy to mount the printing board due to 2.54 mm (0.1 inch) interval of lead pins
- Small dimension and no electrode exposure except lead pins enable the high density mounting.

ORDERING INFORMATION

Part Number	Package	Quality
μPA1550H	10-pin SIP	Standard

Please refer to "Quality Grades on NEC Semiconductor Devices" (Document No. C11531E) published by NEC Corporation to know the specification of quality grade on the devices and its recommended applications.

PACKAGE DRAWING (UNIT: mm)

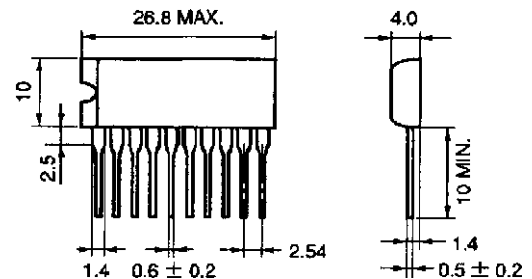

ELECTRODE CONNECTION

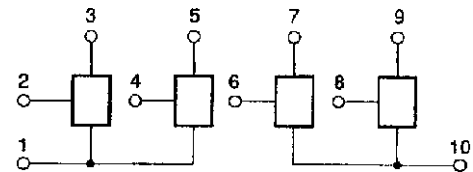

2, 4, 6, 8 : Gate (G)
 3, 5, 7, 9 : Drain (D)
 1, 10 : Source (S)

INTERNAL EQUIVALENT CIRCUIT

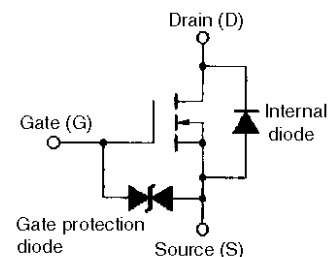

The information in this document is subject to change without notice. Before using this document, please confirm that this is the latest version.
 Not all devices/types available in every country. Please check with local NEC representative for availability and additional information.

ABSOLUTE MAXIMUM RATINGS (Ta = 25°C)

Parameter	Symbol	Conditions	Ratings	Unit
Drain to source voltage	V _{DSS}	V _{GS} = 0	30	V
Gate to source voltage	V _{GSS}	V _{DS} = 0	±20	V
Drain current (DC)	I _{D(DC)}	T _C = 25°C	±5	A/unit
Drain current (pulse)	I _{D(pulse)}	PW ≤ 10 μs duty cycle ≤ 1 %	±20	A/unit
Total power dissipation	P _{T1} *	T _C = 25°C	3.5	W
Total power dissipation	P _{T2} *	T _a = 25°C	28	W
Channel temperature	T _{ch}		150	°C
Storage temperature	T _{stg}		-55 to +150	°C

* When all 4 elements are ON.

ELECTRICAL CHARACTERISTICS (VCC = 5V, Ta = 25°C)

Parameter	Symbol	Conditions	MIN.	TYP.	MAX.	Unit
Drain cutoff current	I _{DSS}	V _{DS} = 30 V, V _{GS} = 0 V			10	μA
Gate leakage current	I _{GSS}	V _{GS} = ±20 V, V _{DS} = 0 V			±100	nA
Gate cutoff voltage	V _{GS(off)}	V _{DS} = 10 V, I _D = 1 mA	0.8		2.5	V
Forward transfer admittance	y _{ts}	V _{DS} = 10 V, I _D = 3 A	4.0	5.0		S
Drain to source on-state resistance	R _{DS(on)1}	V _{GS} = 10 V, I _D = 3 A		90	100	mΩ
Drain to source on-state resistance	R _{DS(on)2}	V _{GS} = 4 V, I _D = 3 A		110	150	mΩ
Input capacitance	C _{iss}	V _{DS} = 10 V		900		pF
Output capacitance	C _{oss}	V _{GS} = 0 V		400		pF
Return capacitance	C _{rss}	f = 1 MHz		100		pF
Turn-on delay time	t _{d(on)}	I _D = 3 A V _{GS(on)} = 10 V		10		ns
Rise time	t _r	V _{DD} = 5 Ω		40		ns
Turn-off delay time	t _{d(off)}	R _L = 5 Ω, R _{in} = 10 Ω		110		ns
Fall time	t _f	Refer to the test circuit.		30		ns

TEST CIRCUIT DIAGRAM: SWITCHING TIME

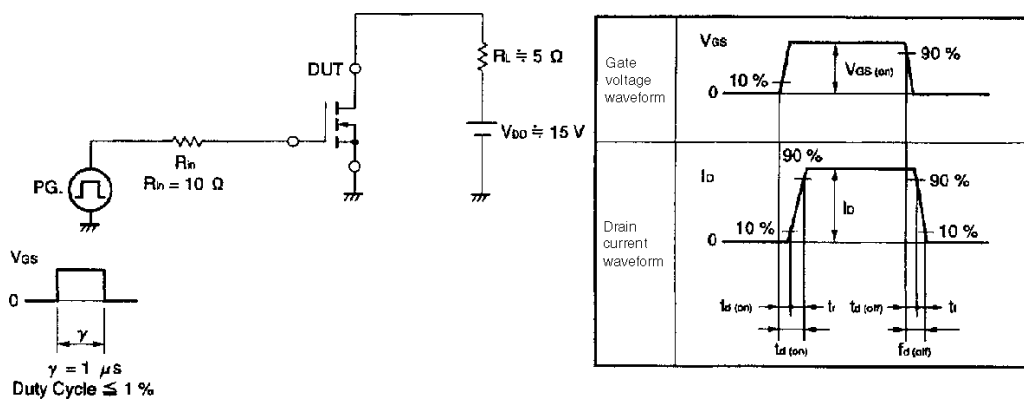

TYPICAL CHARACTERISTICS ($T_a = 25^\circ\text{C}$)

DERATING CURVE OF SAFE OPERATING AREA

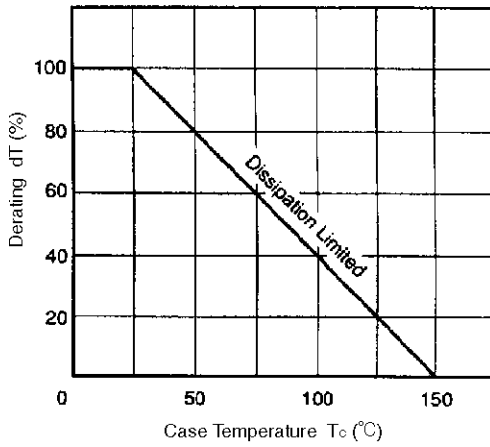

FORWARD BIAS SAFE OPERATING AREA

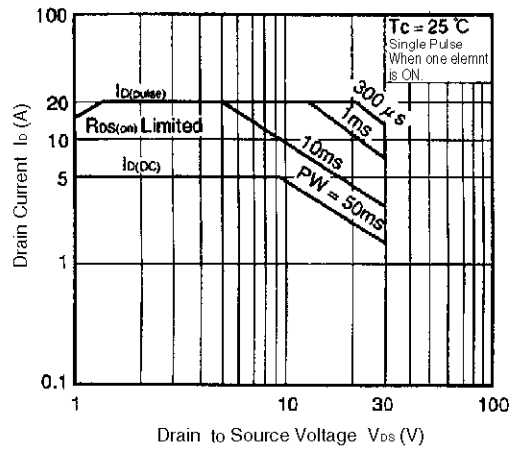

TOTAL POWER DISSIPATION vs. AMBIENT TEMPERATURE

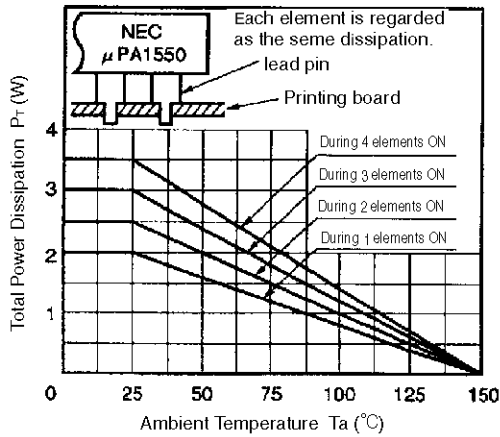

TOTAL POWER DISSIPATION vs. CASE TEMPERATURE

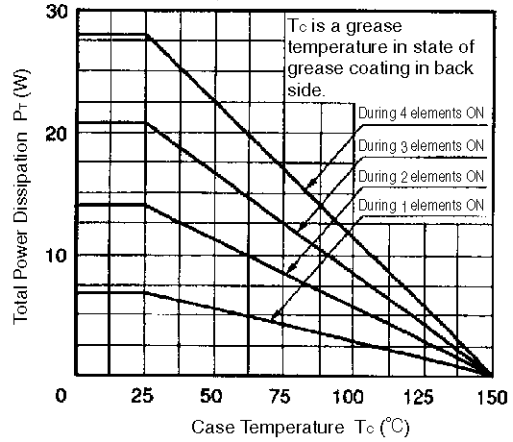

DRAIN CURRENT vs. DRAIN TO SOURCE VOLTAGE

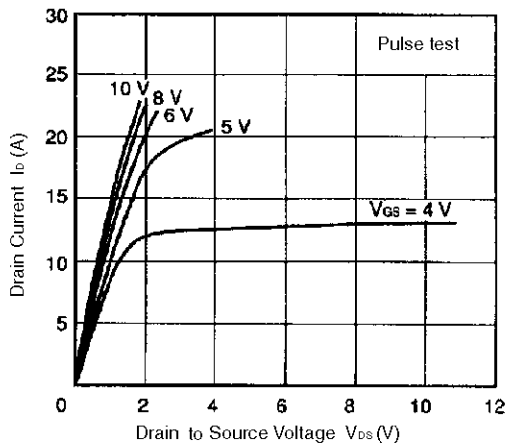

TRANSFER CHARACTERISTICS

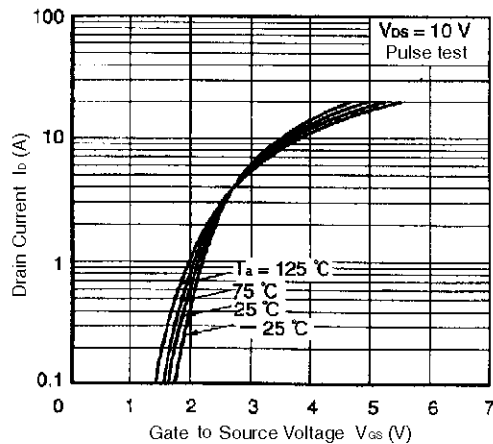

TRANSIENT THERMAL RESISTANCE vs. PULSE WIDTH

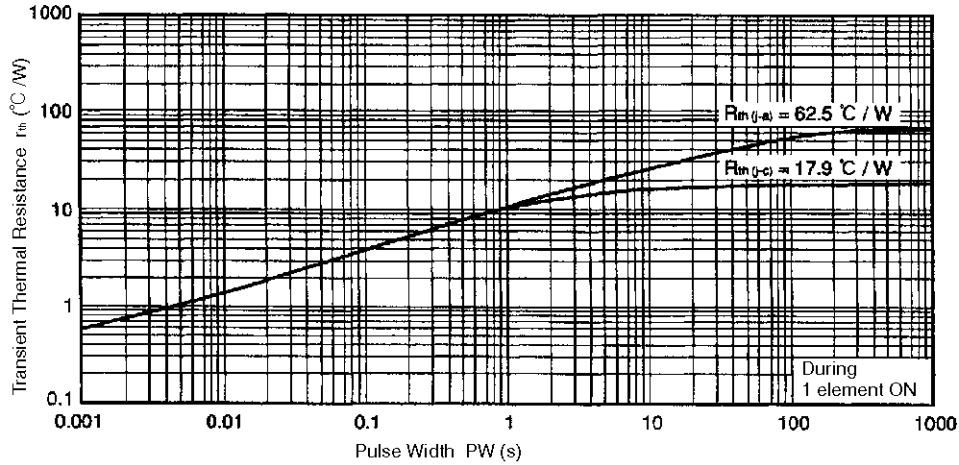

FORWARD TRANSFER ADMITTANCE vs. DRAIN CURRENT

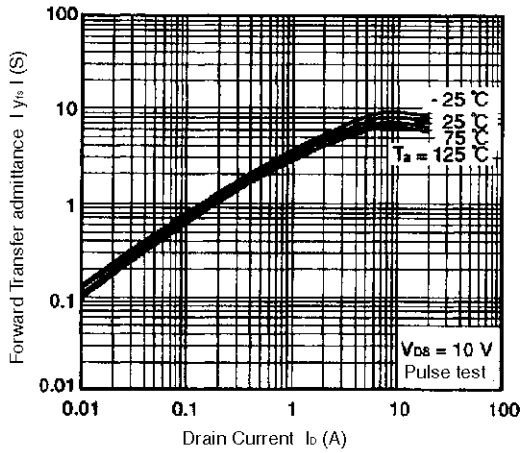

DRAIN TO SOURCE ON STATE RESISTANCE vs. GATE TO SOURCE VOLTAGE

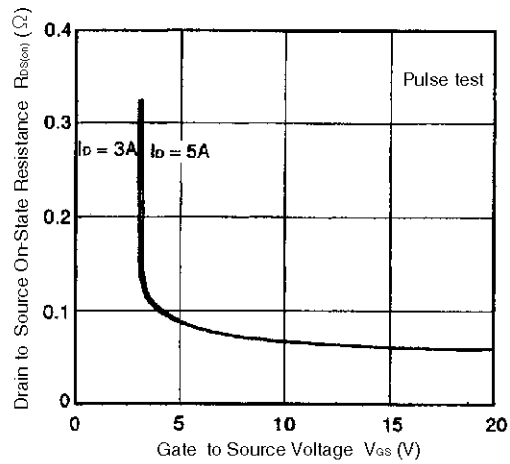

DRAIN TO SOURCE ON STATE RESISTANCE vs. DRAIN CURRENT

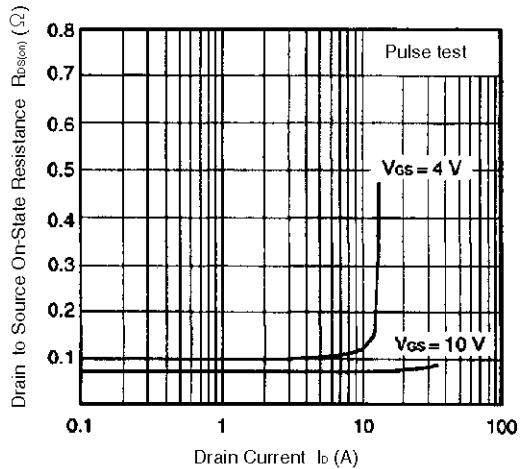

GATE TO SOURCE CUTOFF VOLTAGE vs. CHANNEL TEMPERATURE

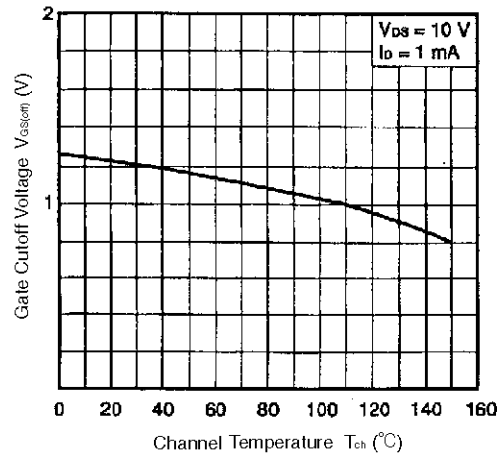

DRAIN TO SOURCE ON - STATE RESISTANCE vs. CHANNEL TEMPERATURE

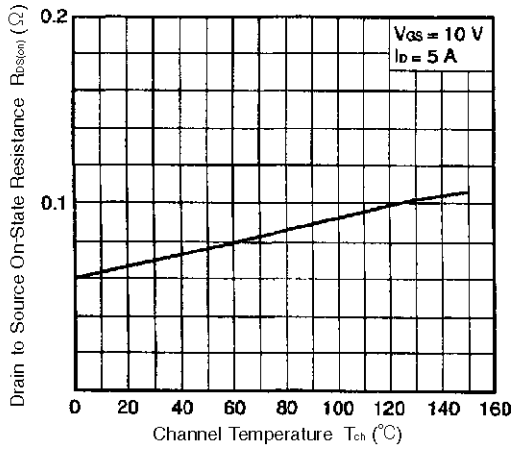

BODY DIODE FORWARD VOLTAGE

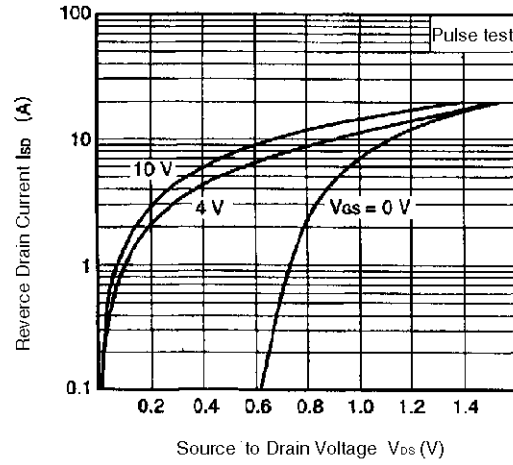

CAPACITANCE vs. DRAIN TO SOURCE VOLTAGE

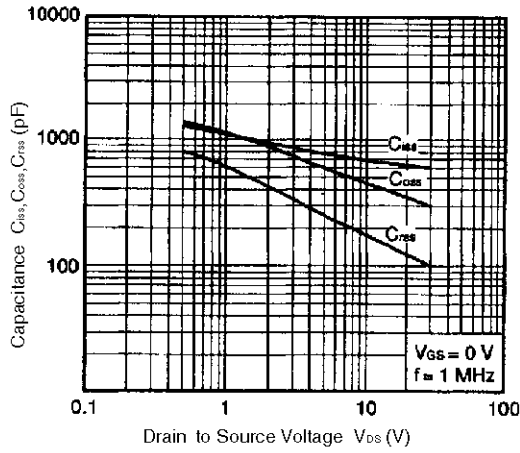

SWITCHING CHARACTERISTICS

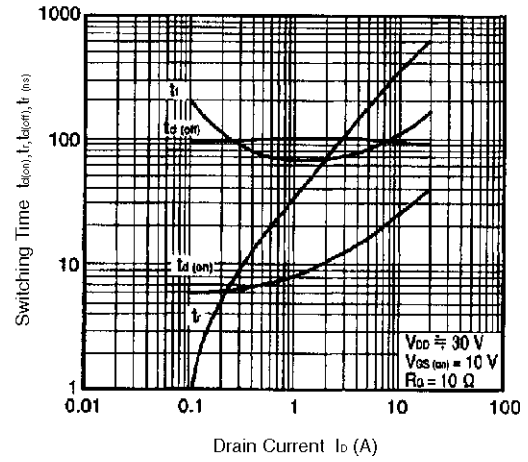

- **The information in this document is current as of July, 2001. The information is subject to change without notice. For actual design-in, refer to the latest publications of NEC's data sheets or data books, etc., for the most up-to-date specifications of NEC semiconductor products. Not all products and/or types are available in every country. Please check with an NEC sales representative for availability and additional information.**
 - No part of this document may be copied or reproduced in any form or by any means without prior written consent of NEC. NEC assumes no responsibility for any errors that may appear in this document.
 - NEC does not assume any liability for infringement of patents, copyrights or other intellectual property rights of third parties by or arising from the use of NEC semiconductor products listed in this document or any other liability arising from the use of such products. No license, express, implied or otherwise, is granted under any patents, copyrights or other intellectual property rights of NEC or others.
 - Descriptions of circuits, software and other related information in this document are provided for illustrative purposes in semiconductor product operation and application examples. The incorporation of these circuits, software and information in the design of customer's equipment shall be done under the full responsibility of customer. NEC assumes no responsibility for any losses incurred by customers or third parties arising from the use of these circuits, software and information.
 - While NEC endeavours to enhance the quality, reliability and safety of NEC semiconductor products, customers agree and acknowledge that the possibility of defects thereof cannot be eliminated entirely. To minimize risks of damage to property or injury (including death) to persons arising from defects in NEC semiconductor products, customers must incorporate sufficient safety measures in their design, such as redundancy, fire-containment, and anti-failure features.
 - NEC semiconductor products are classified into the following three quality grades:
"Standard", "Special" and "Specific". The "Specific" quality grade applies only to semiconductor products developed based on a customer-designated "quality assurance program" for a specific application. The recommended applications of a semiconductor product depend on its quality grade, as indicated below. Customers must check the quality grade of each semiconductor product before using it in a particular application.
 - "Standard": Computers, office equipment, communications equipment, test and measurement equipment, audio and visual equipment, home electronic appliances, machine tools, personal electronic equipment and industrial robots
 - "Special": Transportation equipment (automobiles, trains, ships, etc.), traffic control systems, anti-disaster systems, anti-crime systems, safety equipment and medical equipment (not specifically designed for life support)
 - "Specific": Aircraft, aerospace equipment, submersible repeaters, nuclear reactor control systems, life support systems and medical equipment for life support, etc.
- The quality grade of NEC semiconductor products is "Standard" unless otherwise expressly specified in NEC's data sheets or data books, etc. If customers wish to use NEC semiconductor products in applications not intended by NEC, they must contact an NEC sales representative in advance to determine NEC's willingness to support a given application.
- (Note)
- (1) "NEC" as used in this statement means NEC Corporation and also includes its majority-owned subsidiaries.
 - (2) "NEC semiconductor products" means any semiconductor product developed or manufactured by or for NEC (as defined above).