

TOSHIBA POWER MOS FET MODULE SILICON N & P CHANNEL MOS TYPE (L<sup>2</sup>-π-MOSIV 6 IN 1)

# MP6403

HIGH POWER SWITCHING APPLICATION.  
3-PHASE MOTOR DRIVE AND BIPOLAR DRIVE OF PULSE MOTOR.

- 4-Volt Gate Drive Available
- Small Package by Full Molding (SIP 12 Pin)
- High Drain Power Dissipation (6 Devices Operation)  
: P<sub>T</sub>=36W (Ta=25°C)
- Low Drain-Source ON Resistance  
: R<sub>DS(ON)</sub>=90mΩ (Typ.) (N-ch)  
170mΩ (Typ.) (P-ch)
- Low Leakage Current: I<sub>GSS</sub>=±10μA (Max.) (V<sub>GS</sub>=±16V)  
I<sub>DSS</sub>=100μA (Max.) (V<sub>DS</sub>=60V)
- Enhancement-Mode : V<sub>th</sub>=0.8~2.0V (I<sub>D</sub>=1mA)

MAXIMUM RATINGS (Ta = 25°C)

CHARACTERISTIC	SYMBOL	RATING		UNIT
		N ch	P ch	
Drain-Source Voltage	V <sub>DSS</sub>	60	-60	V
Gate-Source Voltage	V <sub>GSS</sub>	±20	±20	V
Drain Current	I <sub>D</sub>	5	-5	A
Peak Drain Current	I <sub>DP</sub>	20	-20	A
Collector Power Dissipation (1 Device Operation)	P <sub>D</sub>	2.2		W
Collector Power Dissipation (6 Devices Operation)	Ta=25°C	4.4		W
	Tc=25°C	36		
Channel Temperature	T <sub>ch</sub>	150		°C
Storage Temperature Range	T <sub>stg</sub>	-55~150		°C

INDUSTRIAL APPLICATIONS

Unit in mm

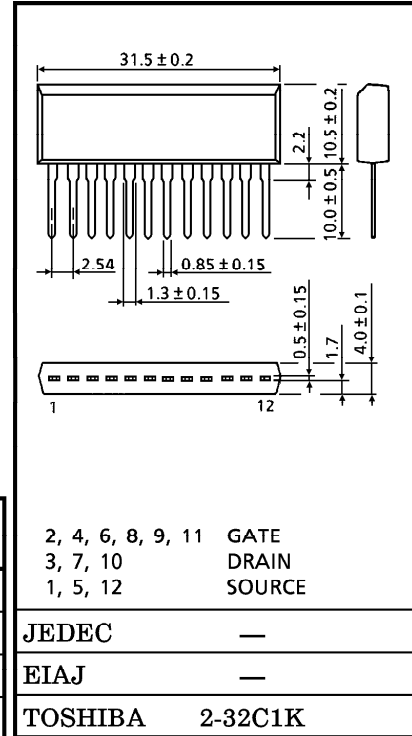

Weight : 3.9g

ARRAY CONFIGURATION

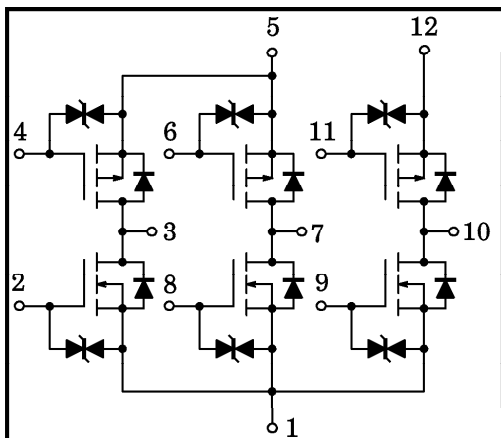

961001EAA2

● TOSHIBA is continually working to improve the quality and the reliability of its products. Nevertheless, semiconductor devices in general can malfunction or fail due to their inherent electrical sensitivity and vulnerability to physical stress. It is the responsibility of the buyer, when utilizing TOSHIBA products, to observe standards of safety, and to avoid situations in which a malfunction or failure of a TOSHIBA product could cause loss of human life, bodily injury or damage to property. In developing your designs, please ensure that TOSHIBA products are used within specified operating ranges as set forth in the most recent products specifications. Also, please keep in mind the precautions and conditions set forth in the TOSHIBA Semiconductor Reliability Handbook.

THERMAL CHARACTERISTICS

CHARACTERISTIC	SYMBOL	MAX.	UNIT
Thermal Resistance of Channel to Ambient (6 Devices Operation, Ta=25°C)	$\Sigma R_{th(ch-a)}$	28.4	°C / W
Thermal Resistance of Channel to Case (6 Devices Operation, Tc=25°C)	$\Sigma R_{th(ch-c)}$	3.47	°C / W
Maximum Lead Temperature for Soldering Purposes (3.2mm from Case for 10s)	T <sub>L</sub>	260	°C

This Transistor is an Electrostatic Sensitive Device. Please Handle with Caution.

961001EAA2'

● The information contained herein is presented only as a guide for the applications of our products. No responsibility is assumed by TOSHIBA CORPORATION for any infringements of intellectual property or other rights of the third parties which may result from its use. No license is granted by implication or otherwise under any intellectual property or other rights of TOSHIBA CORPORATION or others.  
 ● The information contained herein is subject to change without notice.

ELECTRICAL CHARACTERISTICS (Ta = 25°C) (Nch MOS FET)

CHARACTERISTIC		SYMBOL	TEST CONDITION	MIN.	TYP.	MAX.	UNIT
Gate Leakage Current		$I_{GSS}$	$V_{GS} = \pm 16V, V_{DS} = 0$	—	—	$\pm 10$	$\mu A$
Drain Cut-off Current		$I_{DSS}$	$V_{DS} = 60V, V_{GS} = 0$	—	—	100	$\mu A$
Drain-Source Breakdown Voltage		$V_{(BR) DSS}$	$I_D = 10mA, V_{GS} = 0$	60	—	—	V
Gate Threshold Voltage		$V_{th}$	$V_{DS} = 10V, I_D = 1mA$	0.8	—	2.0	V
Forward Transfer Admittance		$ Y_{fs} $	$V_{DS} = 10V, I_D = 2.5A$	3.0	6.0	—	S
Drain-Source ON Resistance		$R_{DS(ON)}$	$I_D = 2.5A, V_{GS} = 4V$	—	135	200	m $\Omega$
		$R_{DS(ON)}$	$I_D = 2.5A, V_{GS} = 10V$	—	90	125	
Input Capacitance		$C_{iss}$	$V_{DS} = 10V, V_{GS} = 0, f = 1MHz$	—	500	—	pF
Reverse Transfer Capacitance		$C_{rss}$		—	90	—	
Output Capacitance		$C_{oss}$		—	290	—	
Switching Time	Rise Time	$t_r$	<p><math>I_D = 2.5A</math> <math>V_{DD} = 30V</math></p>	—	20	—	ns
	Turn-on Time	$t_{on}$		—	60	—	
	Fall Time	$t_f$		—	80	—	
	Turn-off Time	$t_{off}$		$V_{IN} : t_r, t_f < 5ns$ $Du. \leq 1\% (Z_{OUT} = 50\Omega)$	—	300	
Total Gate Charge (Gate-Source Plus Gate-Drain)		$Q_g$	$I_D = 5A, V_{GS} = 10V$ $V_{DD} = 48V$	—	20	—	nC
Gate-Source Charge		$Q_{gs}$		—	14	—	
Gate-Drain (“Miller”) Charge		$Q_{gd}$		—	6	—	

SOURCE-DRAIN DIODE RATINGS AND CHARACTERISTICS (Ta = 25°C)

CHARACTERISTIC	SYMBOL	TEST CONDITION	MIN.	TYP.	MAX.	UNIT
Drain Reverse Current	$I_{DR}$	—	—	—	5	A
Peak Drain Reverse Current	$I_{DRP}$	—	—	—	20	A
Diode Forward Voltage	$V_{DSF}$	$I_{DR} = 5A, V_{GS} = 0$	—	—	-1.5	V
Reverse Recovery Time	$t_{rr}$	$I_{DR} = 5A, V_{GS} = 0$ $dI_{DR} / dt = -50A / \mu s$	—	140	—	ns
Reverse Recovery Charge	$Q_{rr}$		—	0.4	—	$\mu C$

ELECTRICAL CHARACTERISTICS (Ta = 25°C) (Pch MOS FET)

CHARACTERISTIC		SYMBOL	TEST CONDITION	MIN.	TYP.	MAX.	UNIT
Gate Leakage Current		$I_{GSS}$	$V_{GS} = \pm 16V, V_{DS} = 0$	—	—	$\pm 10$	$\mu A$
Drain Cut-off Current		$I_{DSS}$	$V_{DS} = -60V, V_{GS} = 0$	—	—	-100	$\mu A$
Drain-Source Breakdown Voltage		$V_{(BR)DSS}$	$I_D = -10mA, V_{GS} = 0$	-60	—	—	V
Gate Threshold Voltage		$V_{th}$	$V_{DS} = -10V, I_D = -1mA$	-0.8	—	-2.0	V
Forward Transfer Admittance		$ Y_{fs} $	$V_{DS} = -10V, I_D = -2.5A$	1.0	2.0	—	S
Drain-Source ON Resistance		$R_{DS(ON)}$	$I_D = -2.5A, V_{GS} = -4V$	—	250	400	m $\Omega$
		$R_{DS(ON)}$	$I_D = -2.5A, V_{GS} = -10V$	—	170	245	
Input Capacitance		$C_{iss}$	$V_{DS} = -10V, V_{GS} = 0, f = 1MHz$	—	500	—	pF
Reverse Transfer Capacitance		$C_{rss}$		—	90	—	
Output Capacitance		$C_{oss}$		—	290	—	
Switching Time	Rise Time	$t_r$	<p><math>I_D = -2.5A</math> <math>V_{IN} : t_r, t_f &lt; 5ns</math> <math>Du. \leq 1\% (Z_{OUT} = 50\Omega)</math> <math>V_{DD} = -30V</math></p>	—	120	—	ns
	Turn-on Time	$t_{on}$		—	130	—	
	Fall Time	$t_f$		—	80	—	
	Turn-off Time	$t_{off}$		—	200	—	
Total Gate Charge (Gate-Source Plus Gate-Drain)		$Q_g$	$I_D = -5A, V_{GS} = -10V$ $V_{DD} = -48V$	—	22	—	nC
Gate-Source Charge		$Q_{gs}$		—	14	—	
Gate-Drain ("Miller") Charge		$Q_{gd}$		—	8	—	

SOURCE-DRAIN DIODE RATINGS AND CHARACTERISTICS (Ta = 25°C)

CHARACTERISTIC	SYMBOL	TEST CONDITION	MIN.	TYP.	MAX.	UNIT
Drain Reverse Current	$I_{DR}$	—	—	—	-5	A
Peak Drain Reverse Current	$I_{DRP}$	—	—	—	-20	A
Diode Forward Voltage	$V_{DSF}$	$I_{DR} = -5A, V_{GS} = 0$	—	—	1.5	V
Reverse Recovery Time	$t_{rr}$	$I_{DR} = -5A, V_{GS} = 0$ $dI_{DR} / dt = -50A / \mu s$	—	120	—	ns
Reverse Recovery Charge	$Q_{rr}$		—	0.24	—	$\mu C$

Nch FET

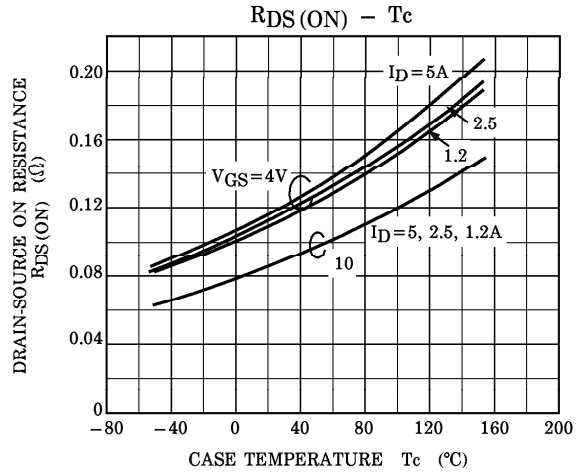
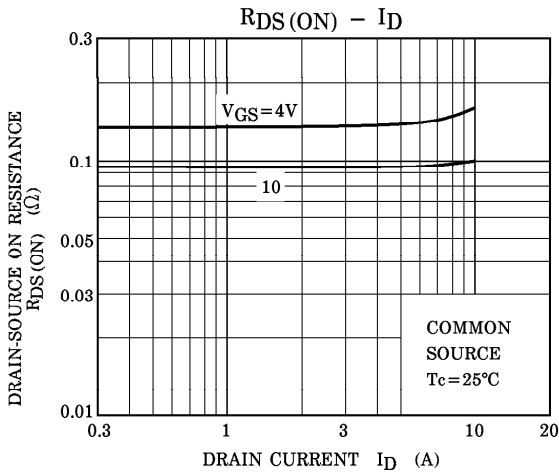
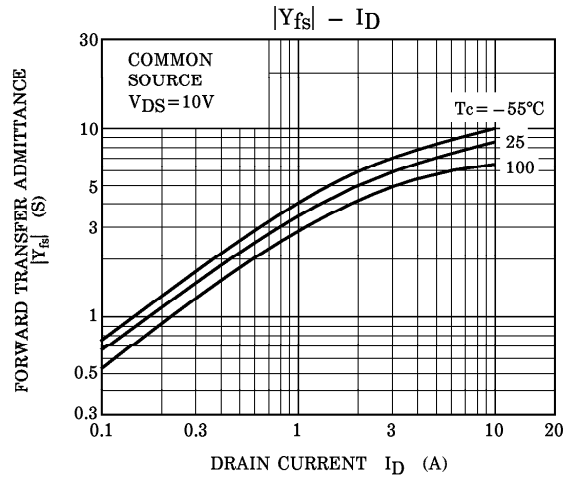
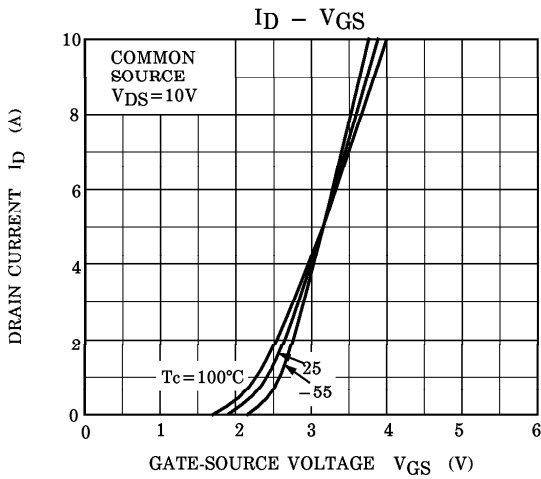
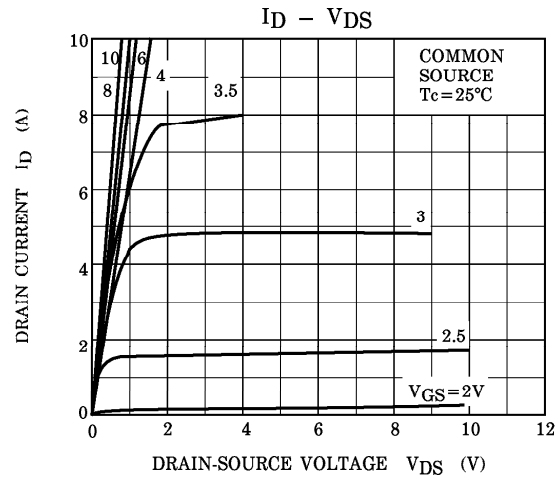
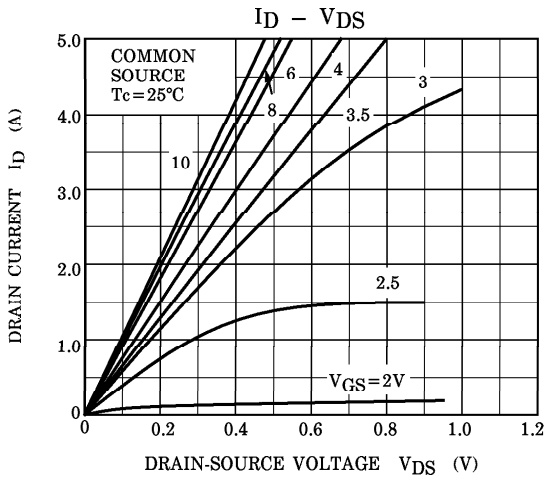

Nch FET

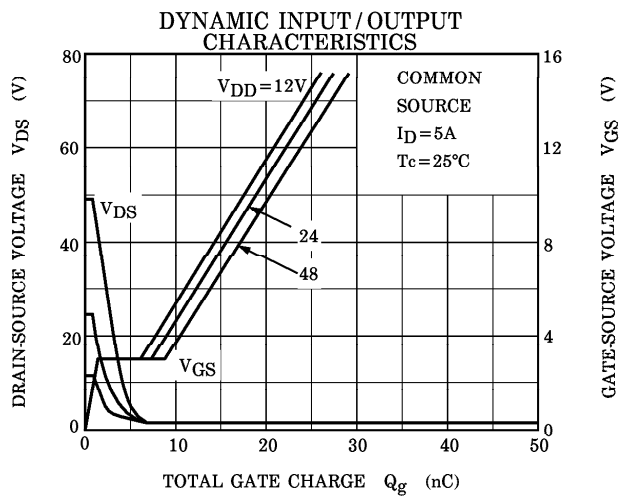
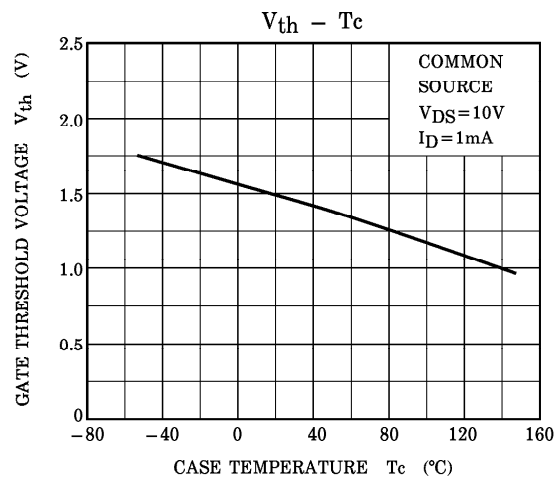
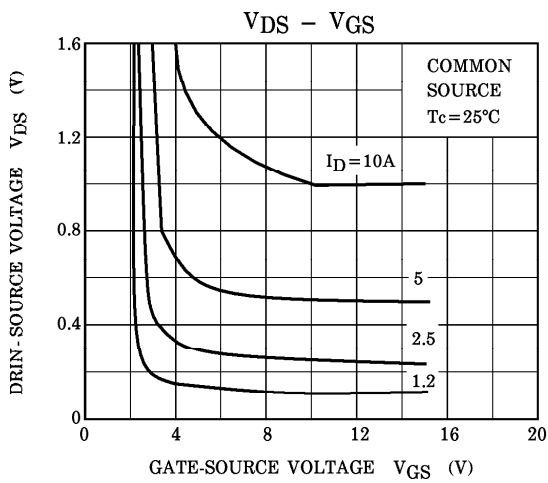
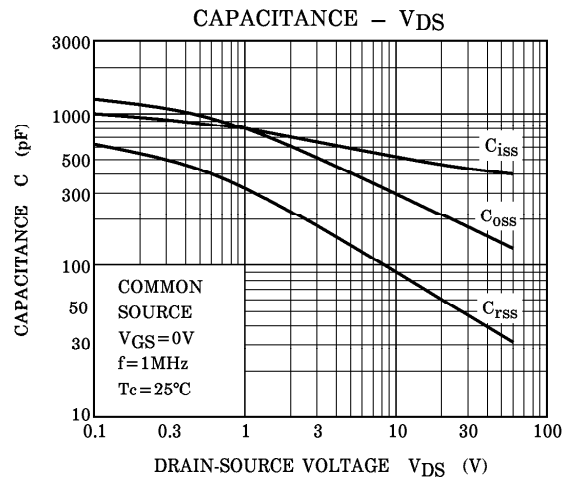
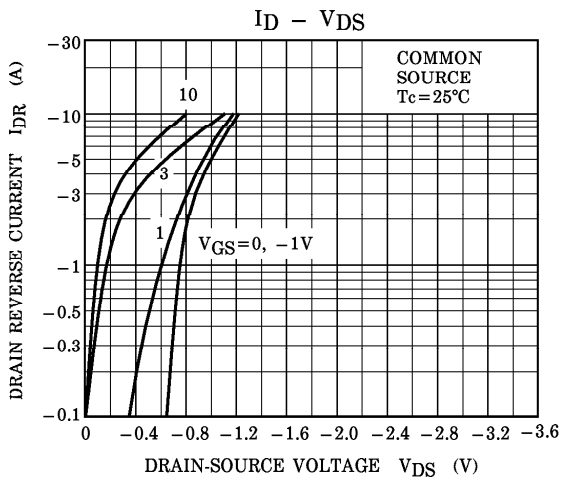

Pch FET

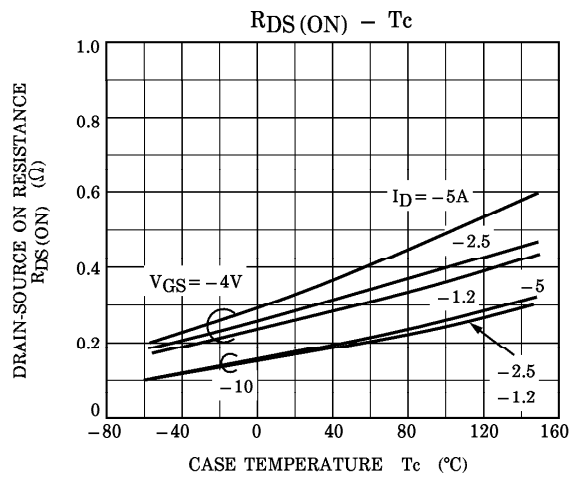
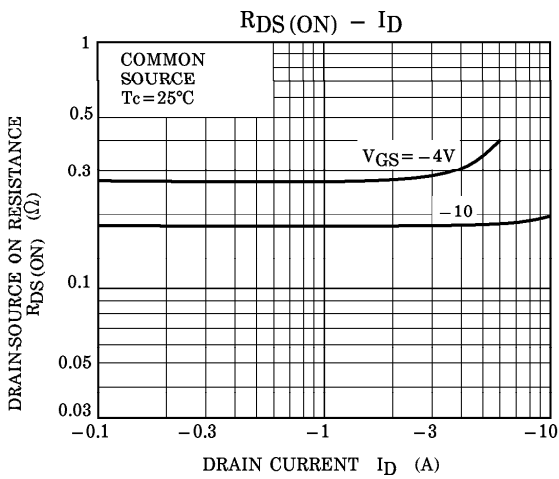
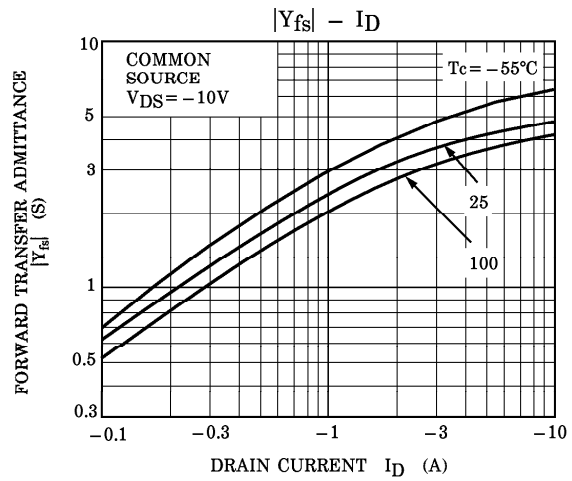
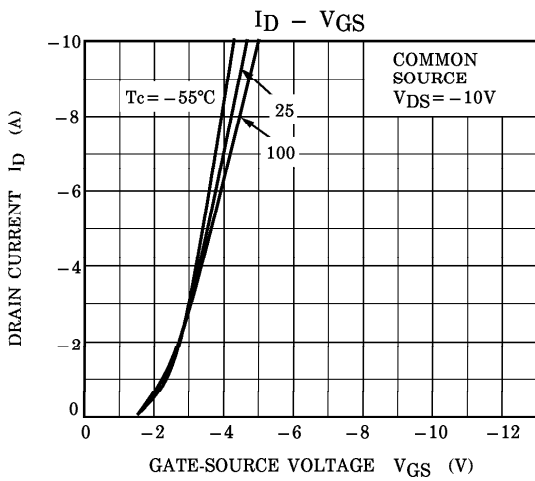
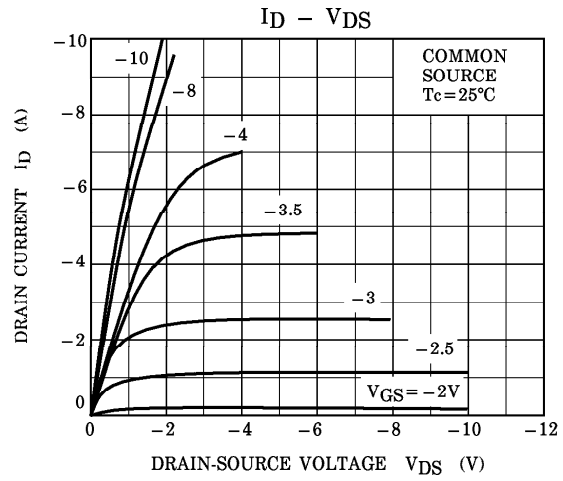
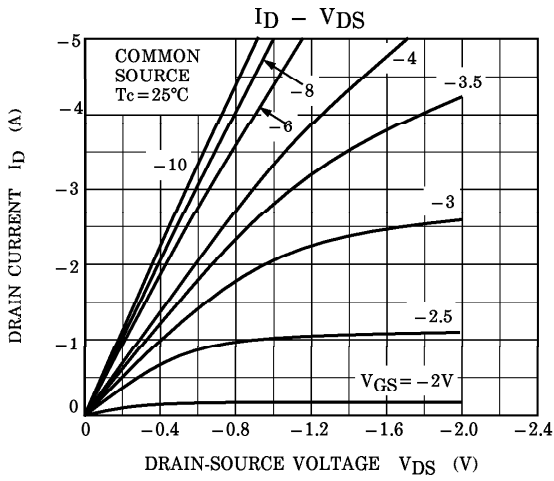

Pch FET

