

S12MD1V/S12MD3

Photothyristor Coupler

* Lead forming type (I type) and taping reel type (P type) of **S12MD1V** are also available. (**S12MD1V/S12MDIP**)

■ Features

1. High RMS ON-state current (I_T : MAX. 200mA_{rms})
 2. High repetitive peak OFF-state voltage (V_{DRM} : MIN. 400V)
 3. Trigger current I_{FT} : MAX. 15mA at $R_G = 20k\Omega$
 4. For half-wave control ••• **S12MD1V**
For full-wave control ••• **S12MD3**
 5. Recognized by UL, file No. E64380
- * **S12MD1V** and **S12MD3** are for 100V line

■ Applications

1. ON-OFF operation for a low power load
2. For triggering high power thyristor and triac

■ Outline Dimensions

(Unit : mm)

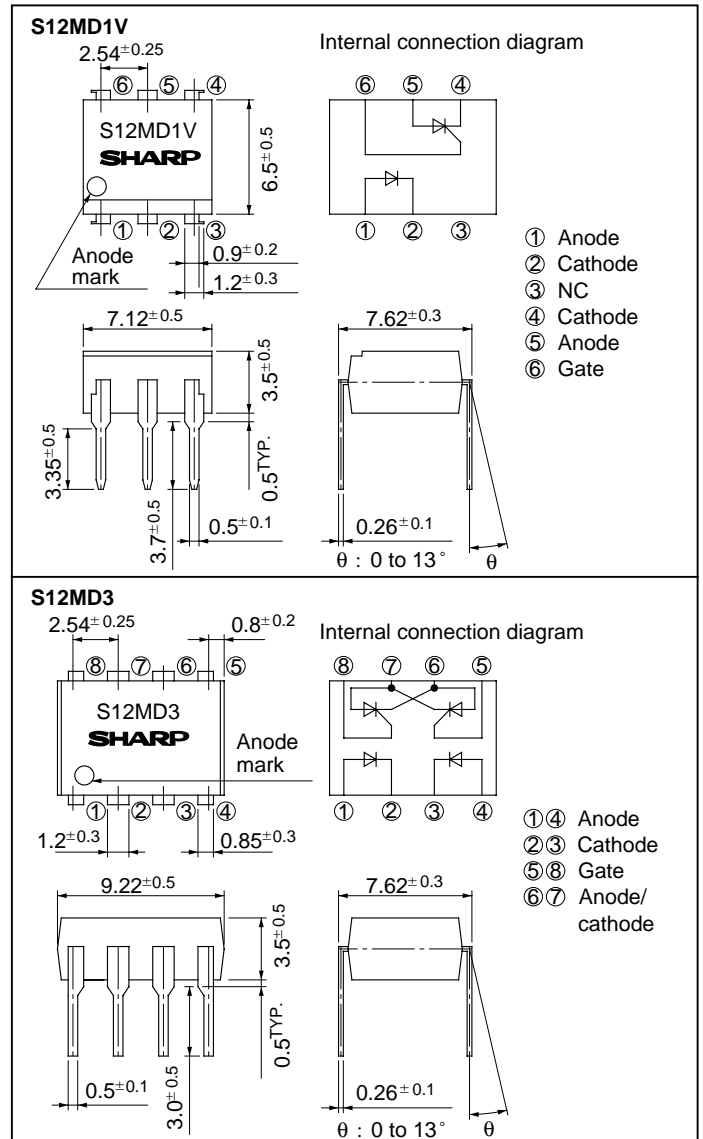

Absolute Maximum Ratings

(Ta = 25°C)

Parameter	Symbol	Rating		Unit
		S12MD1V	S12MD3	
Input	Forward current	50		mA
	Reverse voltage	6		V
Output	RMS ON-state current	200		mA _{rms}
	*1 Peak one cycle surge current	2		A
	*2 Repetitive peak OFF-state voltage	400		V
	*2 Repetitive peak reverse voltage	400	-	V
	*3 Isolation voltage	5 000	1 500	V _{rms}
Operating temperature	T _{opr}	- 30 to + 100		°C
Storage temperature	T _{stg}	- 40 to + 125		°C
*4 Soldering temperature	T _{sol}	260		°C

*1 50Hz, sine wave

*3 40 to 60% RH, AC for 1 minute

*2 R_G = 20kΩ

*4 For 10 seconds

Electro-optical Characteristics

(Ta = 25°C)

Parameter	Symbol	Conditions	MIN.	TYP.	MAX.	Unit
Input	Forward voltage	I _F = 30mA	-	1.2	1.4	V
	Reverse current	V _R = 3V	-	-	10 ⁻⁵	A
Output	Repetitive peak OFF-state current	V _{DRM} = Rated, R _G = 20kΩ	-	-	10 ⁻⁶	A
	*5 Repetitive peak reverse current	V _{RRM} = Rated, R _G = 20kΩ	-	-	10 ⁻⁶	A
	ON-state voltage	I _T = 200mA	-	1.0	1.4	V
	Holding current	V _D = 6V, R _G = 20kΩ	-	0.3	1	mA
	Critical rate of rise of OFF-state voltage	V _{DRM} = 1/√2 Rated, R _G = 20kΩ	3	-	-	V/μs
Transfer-characteristics	Minimum trigger current	V _D = 6V, R _L = 100Ω, R _G = 20kΩ	-	-	15	mA
	Isolation resistance	DC500V, 40 to 60% RH	5 x 10 ¹⁰	10 ¹¹	-	Ω
	Turn-on time	V _D = 6V, I _F = 30mA, R _G = 20kΩ, R _L = 100Ω	-	10	60	μs

*5 Applies only to S12MD1V

Fig. 1 RMS ON-state Current vs. Ambient Temperature

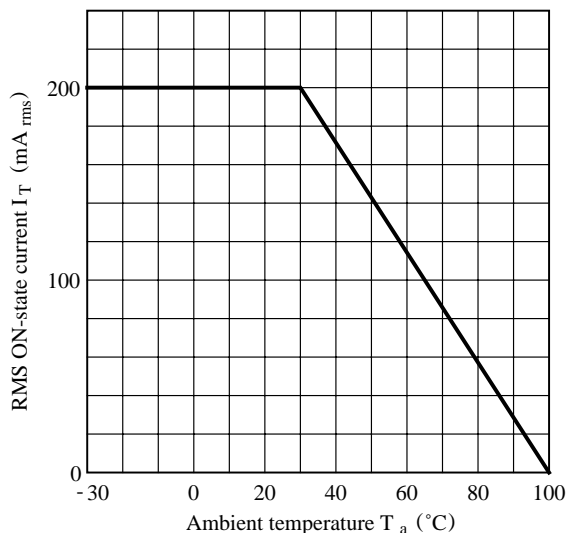

Fig. 2 Forward Current vs. Ambient Temperature

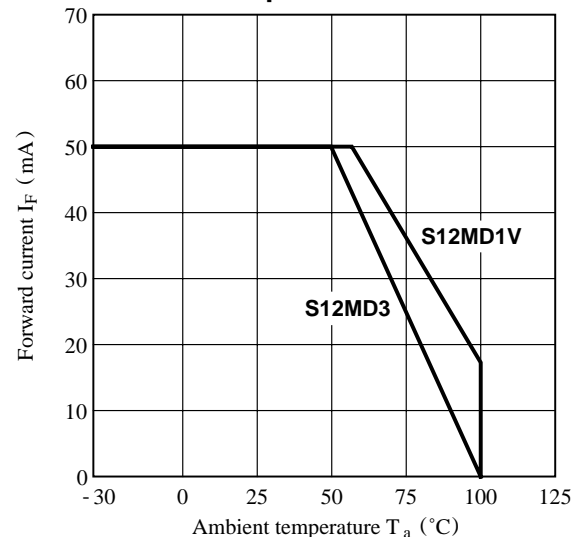

Fig. 3 Forward Current vs. Forward Voltage

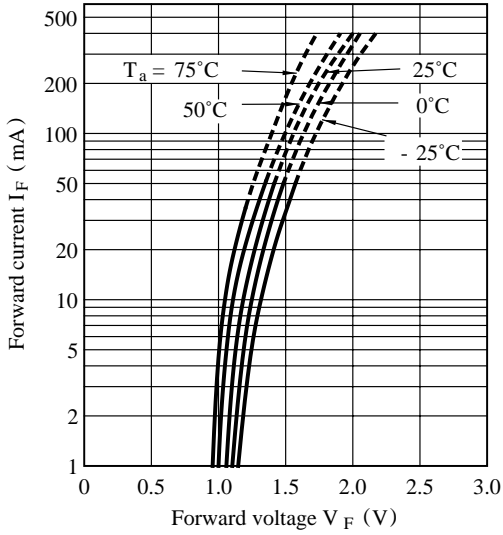

Fig. 4 Minimum Trigger Current vs. Ambient Temperature

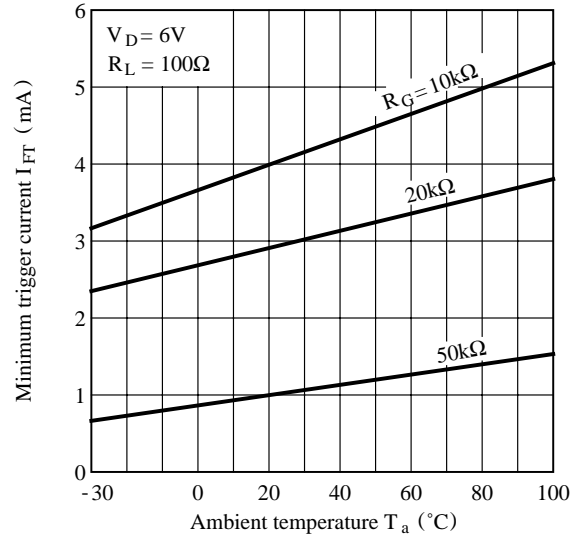

Fig. 5 Minimum Trigger Current vs. Gate Resistance

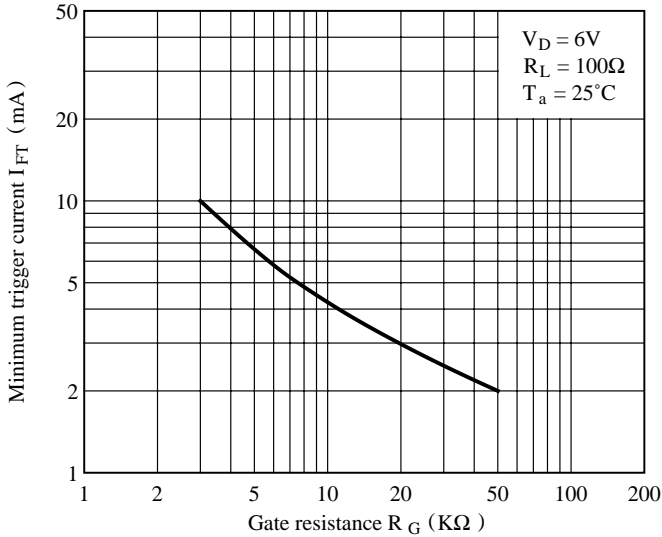

Fig. 6 Break Over Voltage vs. Ambient Temperature

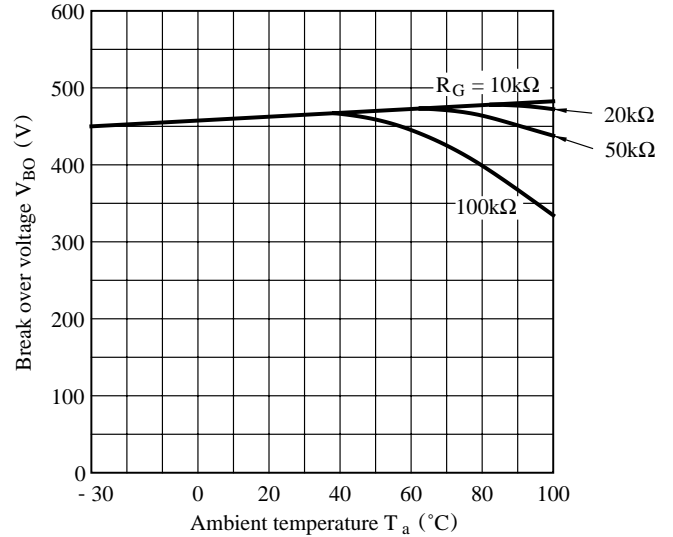

Fig. 7 Critical Rate of Rise of OFF-state Voltage vs. Ambient Temperature

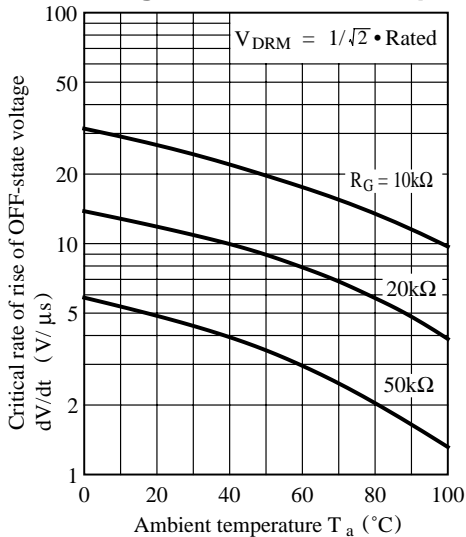

Fig. 8 Holding Current vs. Ambient Temperature

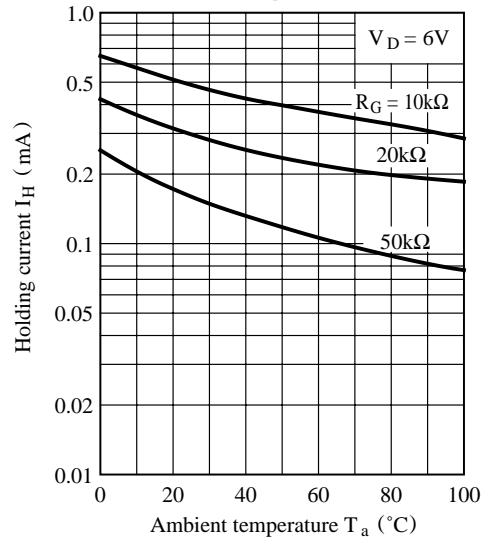
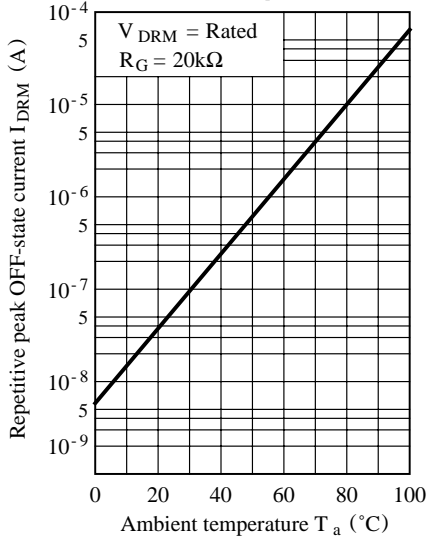

Fig. 9 Repetitive Peak OFF-state Current vs. Ambient Temperature



■ **Basic Operation Circuit**

● **S12MD1V**

Medium/High Power Thyristor Drive Circuit

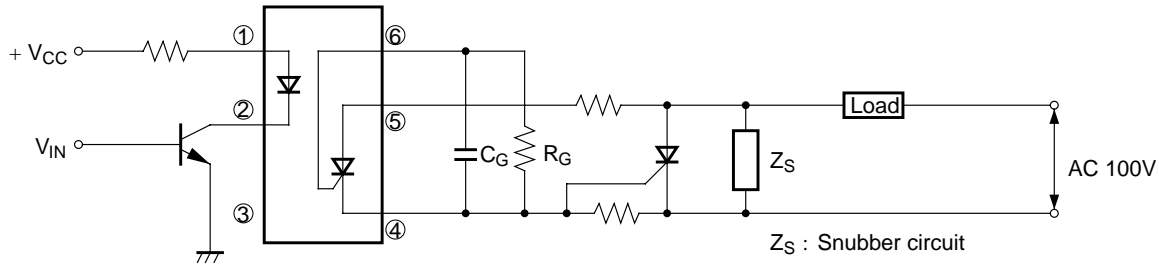

Medium/High Power Triac Drive Circuit (Zero-cross Operation)

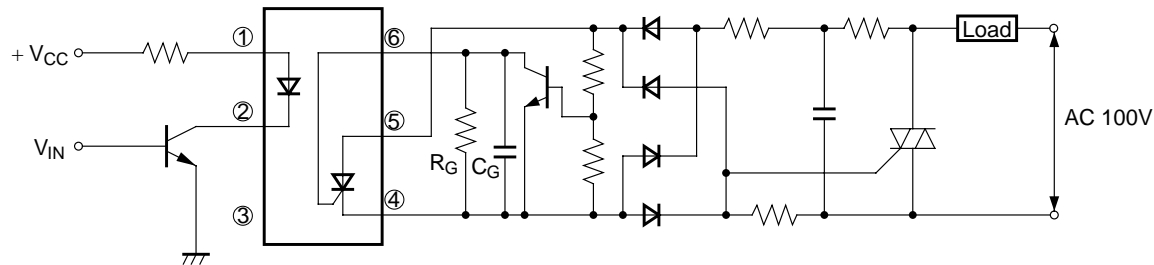

● S12MD3

Low Power Load Drive Circuit

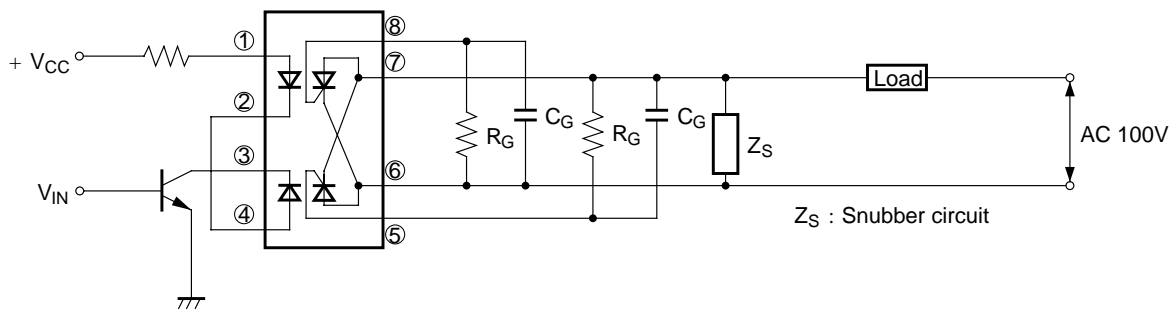

Medium/High Power Triac Drive Circuit

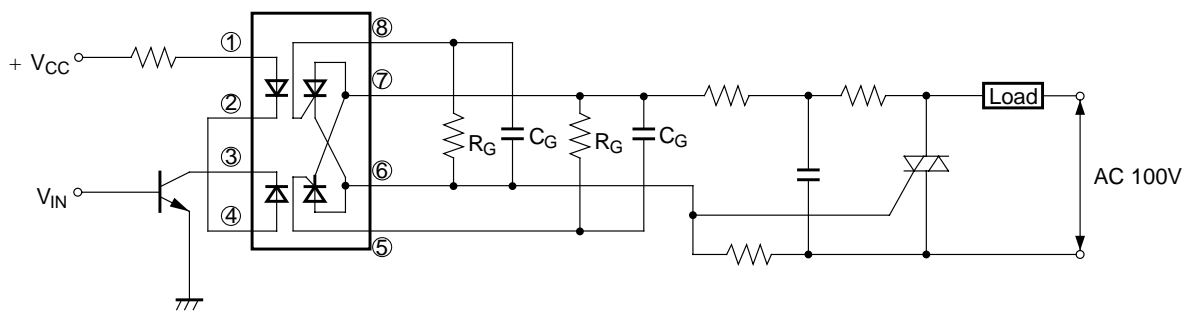

- Please refer to the chapter “Precautions for Use” (Page 78 to 93).