

DESCRIPTION

The SG1536 series of monolithic amplifiers is designed specifically for use in high voltage applications up to $\pm 40V$ and where high common-mode input ranges, high output voltage swings, and low input

currents are required. These devices are internally compensated and are pin compatible with industry standard operational amplifiers.

IMPORTANT: For the most current data, consult MICROSEMI's website: <http://www.microsemi.com>

KEY FEATURES

- High Supply Voltage Capability
- High Output Voltage Swing
- High Common-Mode Voltage Range
- Internal Frequency Compensation
- Input Current 35nA Maximum Over Temperature

HIGH RELIABILITY FEATURES

- Available to MIL-STD-883D and DESC SMD
- Microsemi LEVEL "S" Processing Available

PRODUCT HIGHLIGHT

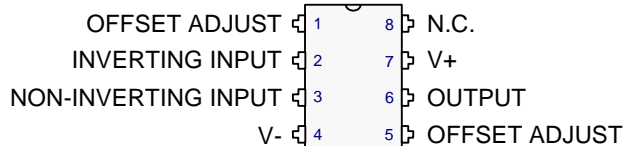

M & Y PACKAGE

(Top View)

M Package: RoHS / Pb-free 100% Matte Tin Lead Finish†

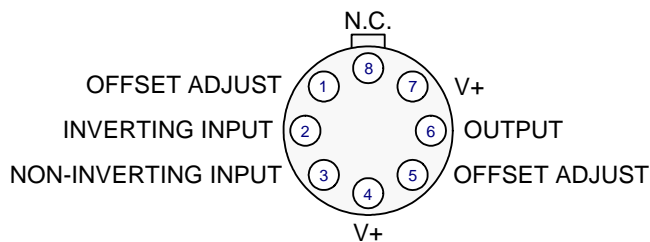

T PACKAGE

(Top View)

PACKAGE ORDER INFO

T _A (°C)	M Plastic DIP 8-Pin	Y Plastic DIP 8-Pin	T TO-99 Metal Can 8-Pin
	RoHS Compliant / Pb-free Transition DC: 0503*		
0 to 70	SG1436M	SG1436Y	SG1436T
-55 to 125	-	SG1536Y	SG1536T
MIL-STD-883	-	SG1536Y/883B	SG1536T/883B
DESC	-	SG1536Y/DESC	SG1536T/DESC

Note: Available in Tape & Reel. Append the letters "TR" to the part number. (i.e. SG1536Y-TR)
†Peak Package Solder Reflow Temperature (40 seconds maximum exposure) 260°C (+0, -5)

HIGH-VOLTAGE OPERATIONAL AMPLIFIER

DESCRIPTION

The SG1536 series of monolithic amplifiers is designed specifically for use in high voltage applications up to $\pm 40V$ and where high common-mode input ranges, high output voltage swings, and low input currents are required. These devices are internally compensated and are pin compatible with industry standard operational amplifiers.

FEATURES

- High supply voltage capability
- High output voltage swing
- High common-mode voltage range
- Internal frequency compensation
- Input current 35nA maximum over temperature

**HIGH RELIABILITY FEATURES
-SG1536**

- ♦ Available to MIL-STD-883 and DESC SMD
- ♦ SG level "S" processing available

CIRCUIT SCHEMATIC

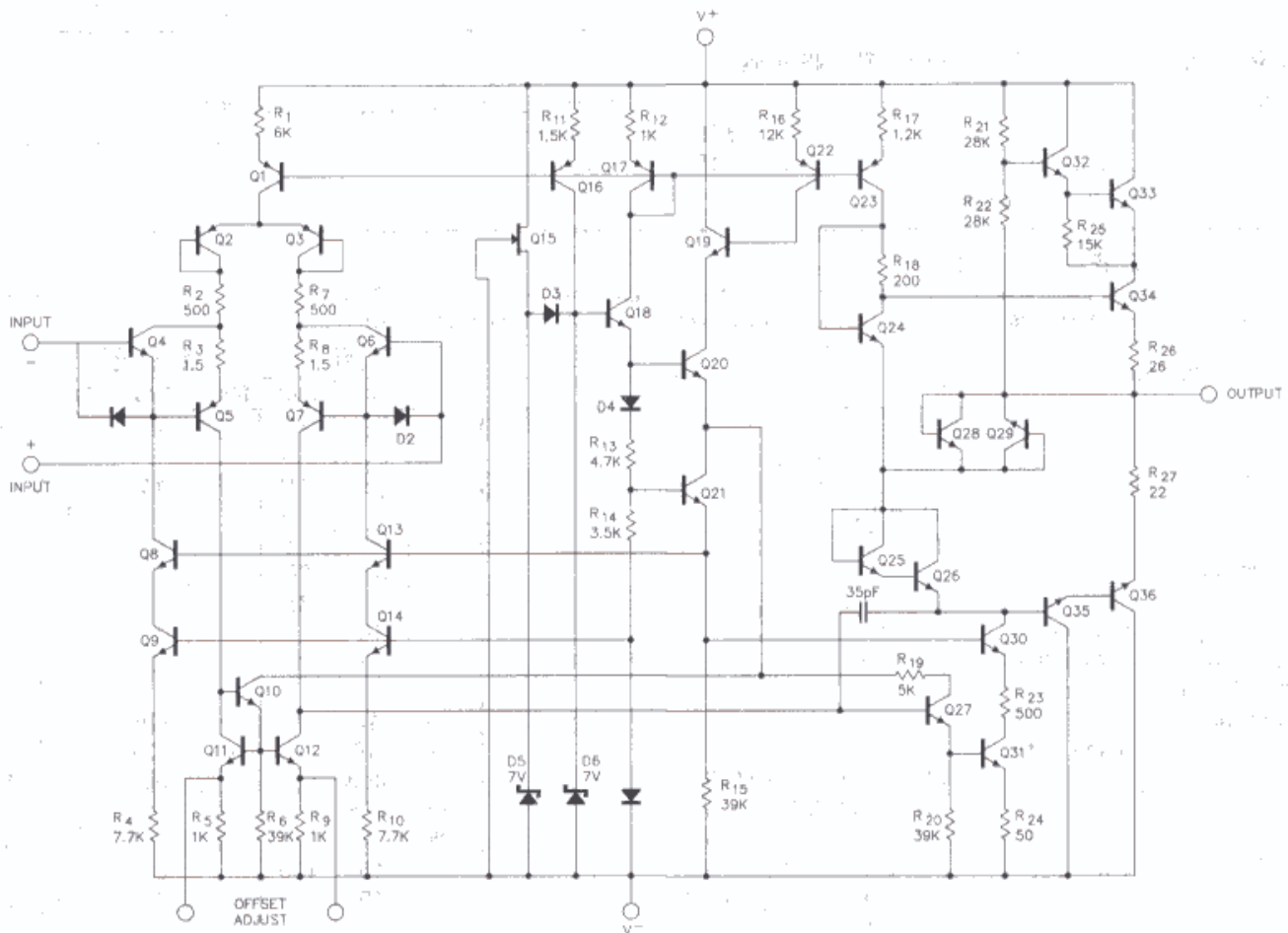

ABSOLUTE MAXIMUM RATINGS (Note 1)

Supply Voltage		
SG1536	±40V	
SG1436	±34V	
Differential Input Signal	±(V ⁺ + V ⁻ - 3) V	
Common-Mode Input Swing	±V ⁺ , -(V ⁻ - 3) V	
Output Short Circuit Duration	(V ⁺ = V ⁻ = 28V, V _O = 0V)	5.0sec
Operating Junction Temperature		
Hermetic (T, Y-Package)		150°C
Storage Temperature Range		-65°C to 150°C
Lead Temperature (Soldering, 10 Seconds)		300°C

Note 1. Exceeding these ratings could cause damage to the device.

THERMAL DERATING CURVES

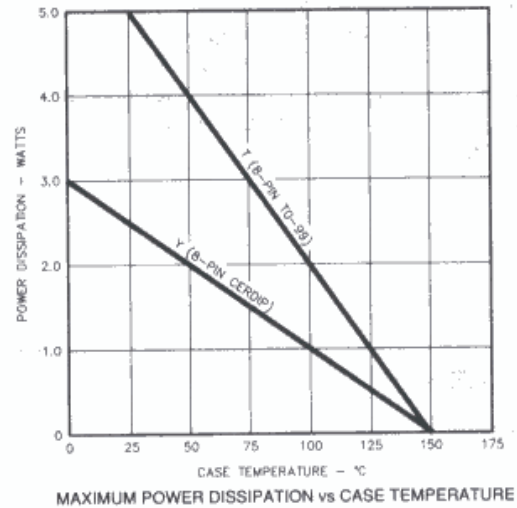
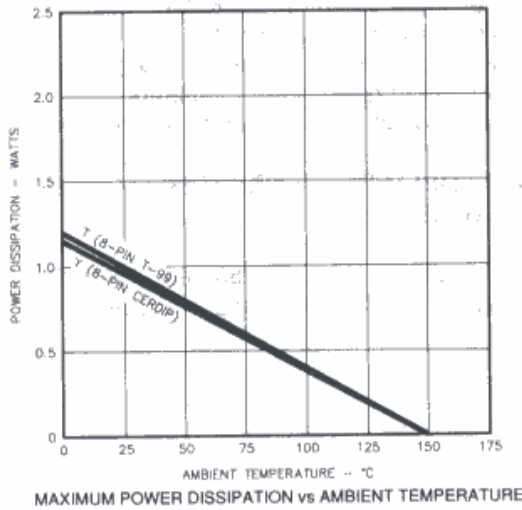

RECOMMENDED OPERATING CONDITIONS (Note 2)

Supply Voltage		Operating Ambient Temperature Range (T _J)
SG1536	±28V	SG1536 -55°C to 125°C
SG1436	±15V	SG1436 0°C to 70°C

Note 2. Range over which the device is functional.

ELECTRICAL SPECIFICATIONS

(Unless otherwise specified, these specifications apply for the operating ambient temperature of T_A = 25°C, and V_O = ±28V. Low duty cycle pulse testing techniques are used which maintains junction and case temperatures equal to the ambient temperature.)

Parameter	Test Conditions	SG1536			SG1436			Units
		Min.	Typ.	Max.	Min.	Typ.	Max.	
Input Offset Voltage			2.0	5.0		5.0	10	mV
Input Offset Current	T _A = T _{MIN} to T _{MAX}			7.0			14	mV
			1.0	3.0		5.0	10	nA
Input Bias Current	T _A = T _{MIN}			7.0			14	nA
	T _A = T _{MAX}			4.5			14	nA
			8.0	20		15	40	nA
Differential Input Impedance	T _A = T _{MIN} to T _{MAX} Open loop, ≤ 5.0Hz		10			10		MΩ
Common-Mode Input Impedance	f ≤ 5.0Hz		250			250		MΩ
Common-Mode Input Voltage Range (Peak)		±24	±25		±22	±25		V
Common-Mode Rejection Ratio		80	110		70	100		dB
Large Signal Voltage Gain	R _L = 10KΩ, V _O = ±10V		200K			200K		V/V
	R _L = 100KΩ, V _O = ±10V	100K	500K		70K	500K		V/V
Power Supply Rejection Ratio	T _A = T _{MIN} to T _{MAX} V ⁻ constant, R _S ≤ 10KΩ		15	100		35	200	μV/V
	V ⁺ constant, R _S ≤ 10KΩ		15	100		35	200	μV/V
Output Impedance	f ≤ 5.0Hz		1.0			1.0		KΩ
Short Circuit Output Current			±17			±17		mA
Output Voltage Swing (Peak)	R _L = 5.0 KΩ, V _S = ±28V	±22			±22			V
	R _L = 5.0 KΩ, V _S = ±36V	±30			±30			V

ELECTRICAL SPECIFICATIONS (continued)

Parameter	Test Conditions	SG1536			SG1436			Units
		Min.	Typ.	Max.	Min.	Typ.	Max.	
Power Bandwidth	$A_v = +1, R_L = 5.0K\Omega, THD \leq 5\%, V_o = 40V\ p-p$		23			23		KHz
Unity Gain Crossover Frequency	Open loop		1.0			1.0		MHz
Slew Rate	Unity gain		2.0			2.0		V/ μ s
Phase Margin	Open loop, unity gain		50			50		deg
Gain Margin			18			18		dB
Equivalent Input Noise	$A_v = 100, R_s = 10K\Omega, f = 1.0KHz, BW = 1.0\ Hz$		50			50		nV/ \sqrt{Hz}
Power Supply Current		2.2	4.0		2.6	5.0		mA
Power Consumption	$V_o = 0$	124	224		146	280		mW

CHARACTERISTIC CURVES

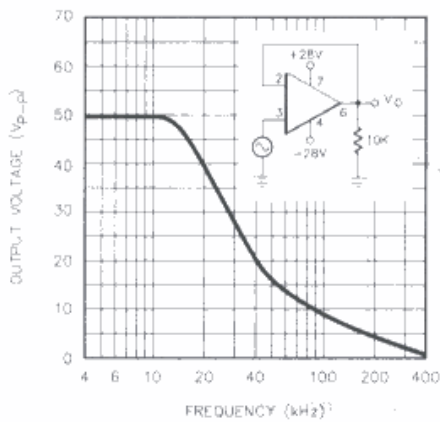

FIGURE 1. POWER BANDWIDTH

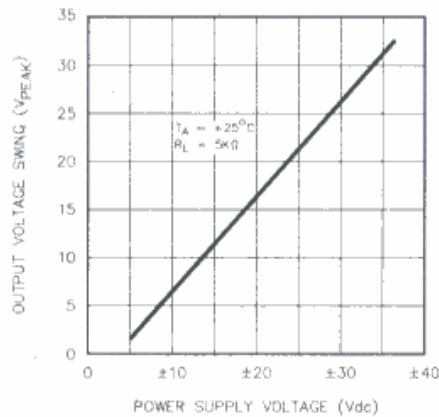

FIGURE 2. PEAK OUTPUT VOLTAGE SWING VS. POWER SUPPLY VOLTAGE

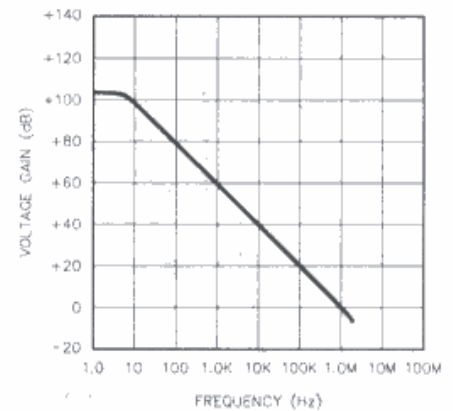

FIGURE 3. OPEN-LOOP FREQUENCY RESPONSE

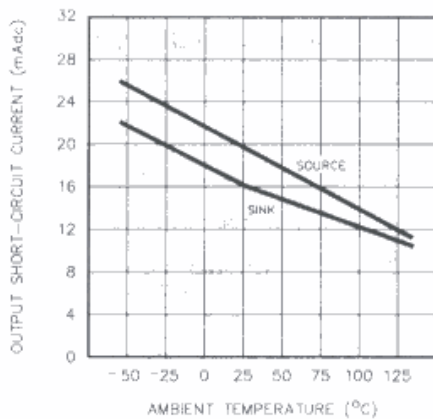

FIGURE 4. OUTPUT SHORT-CIRCUIT CURRENT VS. TEMPERATURE

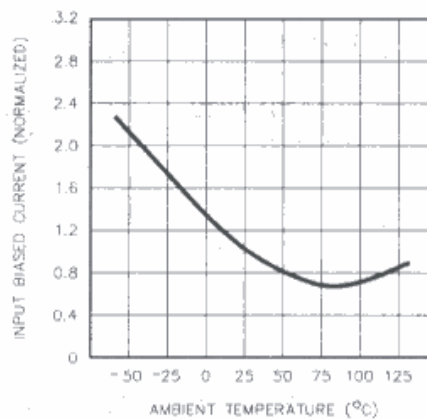

FIGURE 5. INPUT BIAS CURRENT VS. TEMPERATURE

TYPICAL APPLICATIONS

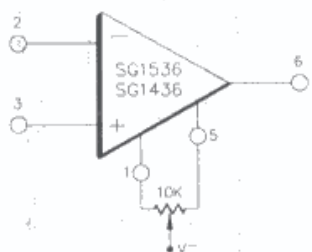

FIGURE 6 - VOLTAGE OFFSET NULL CIRCUIT

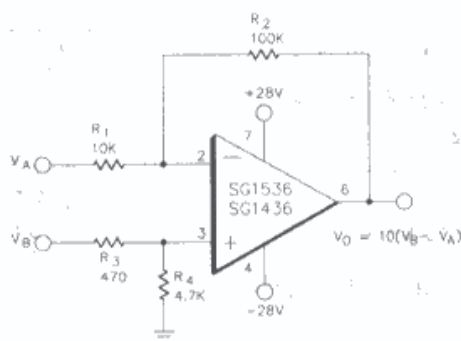

FIGURE 7 - DIFFERENTIAL AMPLIFIER WITH ±20V COMMON-MODE INPUT VOLTAGE RANGE

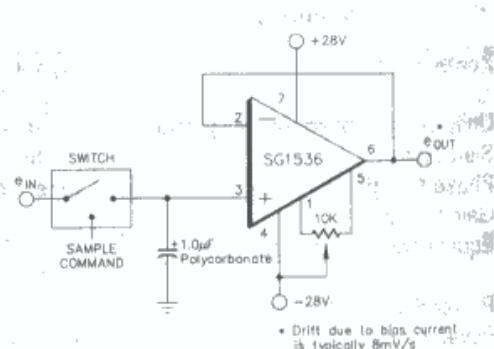

FIGURE 8 - LOW-DRIFT SAMPLE AND HOLD

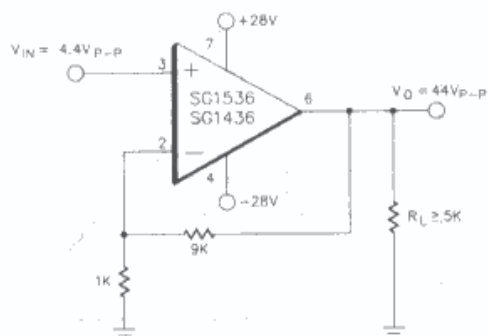

FIGURE 9 - TYPICAL NON-INVERTING X10 VOLTAGE AMPLIFIER

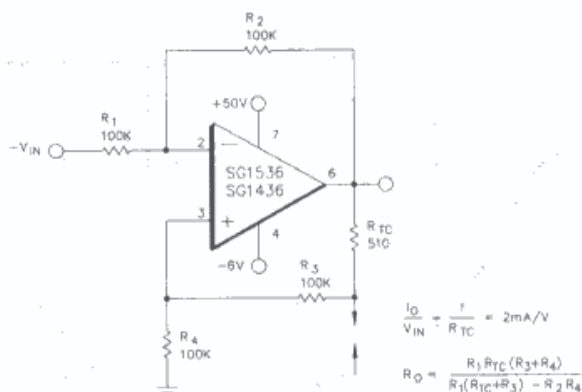

FIGURE 10 - VOLTAGE CONTROLLED CURRENT SOURCE OR TRANSCONDUCTANCE AMPLIFIER WITH 0 TO 40V COMPLIANCE

CONNECTION DIAGRAMS & ORDERING INFORMATION (See Notes Below)

Package	Part No.	Ambient Temperature Range	Connection Diagram
8-PIN METAL CAN T - PACKAGE	SG1536T/883B SG1536T SG1436T	-55°C to 125°C -55°C to 125°C 0°C to 70°C	
8-PIN CERAMIC DIP Y - PACKAGE	SG1536Y/883B SG1536Y SG1436Y	-55°C to 125°C -55°C to 125°C 0°C to 70°C	

Note 1. Contact factory for JAN and DESC product availability.
2. All packages are viewed from the top.