

SANYO

No. 2258E

LC6543C, 6543H, 6546C, 6546H

CMOS LSI
 SINGLE-CHIP 4-BIT MICROCOMPUTER FOR
 SMALL-SCALE CONTROL-ORIENTED
 APPLICATIONS

The LC6543C/H, LC6546C/H belong to our single-chip 4-bit microcomputer LC6500 series fabricated using CMOS process technology and are suited for use in small-scale control-oriented applications. Their basic architecture and instruction set are the same. Application areas include audio equipment (tape deck, player, etc.), office equipment, communications equipment, car equipment, home appliances as well as circuits so far formed with standard logic circuits and applications where the number of controls is small.

Features

- 1) CMOS technology for low-power operation (with instruction-controlled standby function)
- 2) ROM/RAM
 - LC6543C/H ROM: 2K x 8 bits, RAM: 128 x 4 bits
 - LC6546C/H ROM: 1K x 8 bits, RAM: 64 x 4 bits
- 3) Instruction set: 80 instructions common to the LC6500 series
- 4) Wide operating voltage range from 3.0 V to 6.0 V (C version)
- 5) Instruction cycle time of 0.92 usec. (H version)
- 6) On-chip serial I/O port
- 7) Flexible I/O ports
 - Number of ports: 7 ports/25 pins max.
 - All ports: Input/output common
 - Input/output voltage 15 V max. (open drain type)
 - Output current 20 mA max. (sink current) (LED direct drivable)
 - Option selectable for your intended system
 - (A) Open drain output, pull-up resistor: Single-bit select for all ports
 - (B) Output level at the reset mode: 4-bit select of H/L level for port C/D
- 8) Interrupt function
 - Vectored interrupt by timer overflow (instruction-testable)
 - Vectored interrupt by INT pin or completion of transmit/receive at serial I/O port (instruction-testable)
- 9) Stack level: 4 levels (common with Interrupt)
- 10) Timer: 4-bit prescaler + 8 bit programmable timer
- 11) Clock oscillation option selectable for your intended system
 - Oscillator option: 1-pin C oscillation (with R), 2-pin RC oscillation (C version), 2-pin ceramic resonator oscillation, 1-pin external clock (C version and H version), crystal oscillation (C version and H version constants being checked)
 - Predivider option: No predivider, 1/3 predivider, 1/4 predivider (C version)
- 12) Burst pulse (64 x cycle time, duty 50%) output function

Specifications and information herein are subject to change without notice.

SANYO Electric Co., Ltd. Semiconductor Business Headquarters
 TOKYO OFFICE Tokyo Bldg., 1-10, 1 Chome, Ueno, Taito-ku, TOKYO, 110 JAPAN

LC6543C, 6543H, 6546C, 6546H

| Item | | LC6543C | LC6543H | LC6546C | LC6546H |
|-------------------|----------------------------|---|---------------------------------------|--|---------------------------------------|
| Memory | ROM | 2048 x 8 bits | 2048 x 8 bits | 1024 x 8 bits | 1024 x 8 bits |
| | RAM | 128 x 4 bits | 128 x 4 bits | 64 x 4 bits | 64 x 4 bits |
| Instruction | Instruction set | 80 | 80 | 80 | 80 |
| | Table read | With | With | With | With |
| On-chip function | Interrupt | External 1, Internal 1 | External 1, Internal 1 | External 1, Internal 1 | External 1, Internal 1 |
| | Timer | 4-bit prescaler + 8-bit timer | 4-bit prescaler + 8-bit timer | 4-bit prescaler + 8-bit timer | 4-bit prescaler + 8-bit timer |
| | Stack level | 4 | 4 | 4 | 4 |
| | Standby function | Standby available by HALT instruction | Standby available by HALT instruction | Standby available by HALT instruction | Standby available by HALT instruction |
| Input/output port | Number of ports | I/O 25 max. | I/O 25 max. | I/O 25 max. | I/O 25 max. |
| | Serial port | 4/8-bit I/O | 4/8-bit I/O | 4/8-bit I/O | 4/8-bit I/O |
| | I/O voltage | 15V max. | 15V max. | 15V max. | 15V max. |
| | Output current | 10mA typ. 20mA max. | 10mA typ. 20mA max. | 10mA typ. 20mA max. | 10mA typ. 20mA max. |
| | I/O circuit configuration | Open drain (N channel) or pull-up resistor-provided output selectable bit by bit. | | | |
| | Output level at reset mode | "H" or "L" level selectable port by port (port C, D only) | | | |
| | Burst pulse output | Available | Available | Available | Available |
| Characteristic | Minimum cycle time | 2.77µs (VDD=4V) 6.0µs (VDD=3V) | 0.92µs | 2.77µs (VDD=4V) 6.0µs (VDD=3V) | 0.92µs |
| | Supply voltage | 3 to 6V | 4.5 to 6V | 3 to 6V | 4.5 to 6V |
| | Current dissipation | 2.5mA typ. | 4mA typ. | 2.5mA typ. | 4mA typ. |
| Oscillation | Resonator | RC (600kHz typ.) Ceramic (400k, 800k, 1MHz, 4MHz) | Ceramic 4MHz | RC (600kHz typ.) Ceramic (400k, 800k, 1MHz, 4MHz) | Ceramic 4MHz |
| | Predivider option | 1/1, 1/3, 1/4 | 1/1 | 1/1, 1/3, 1/4 | 1/1 |
| Other | Package | DIP30 shrink type, MFP30S | DIP30 shrink type, MFP30S | DIP30 shrink type, MFP30S | DIP30 shrink type, MFP30S |

Note) Information on the resonator and oscillation circuit constants will be presented as soon as the recommended circuit is determined.

Case Outline 3073A-M301C
(unit: mm)

When mounting the MFP version on the board, do not dip it in solder.

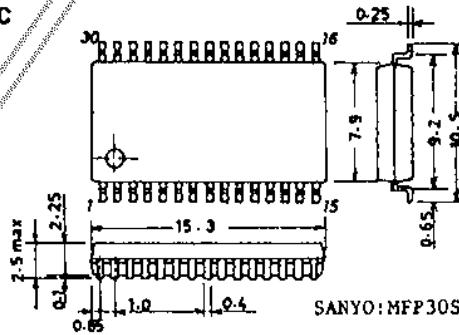

Pin Assignment

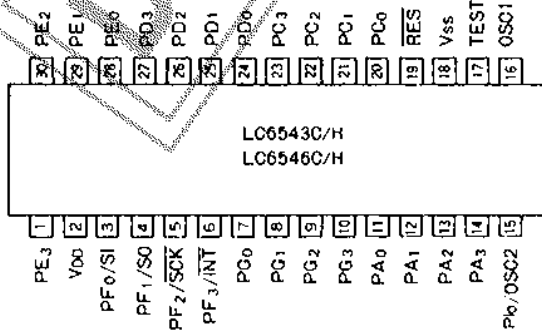

Case Outline 3061-D30S1C
(unit: mm)

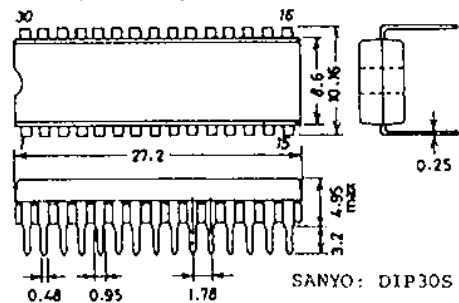

Common to DIP/MFP

Pin Name

| | | | |
|------------|-------------------------------------|------|---------------------------------|
| OSC1, OSC2 | : R, C or ceramic resonator for OSC | TEST | : Test |
| RES | : Reset | INT | : Interrupt request pin |
| PA0 to 3 | : Input/output common port A0 to 3 | SI | : Serial input pin |
| PC0 to 3 | : Input/output common port C0 to 3 | SO | : Serial output pin |
| PD0 to 3 | : Input/output common port D0 to 3 | SCK | : Serial clock input/output pin |
| PE0 to 3 | : Input/output common port E0 to 3 | | |
| PF0 to 3 | : Input/output common port F0 to 3 | | |
| PG0 to 3 | : Input/output common port G0 to 3 | | |
| PI0 | : Input/output common port I0 | | |

Note) • The SI, SO, SCK, and INT pins are common to the PF0 to PF3 pins respectively.
 • The OSC2 pin and PI0 pin are common to each other, but are mutually exclusive. Either pin is user-selectable.

System Block Diagram

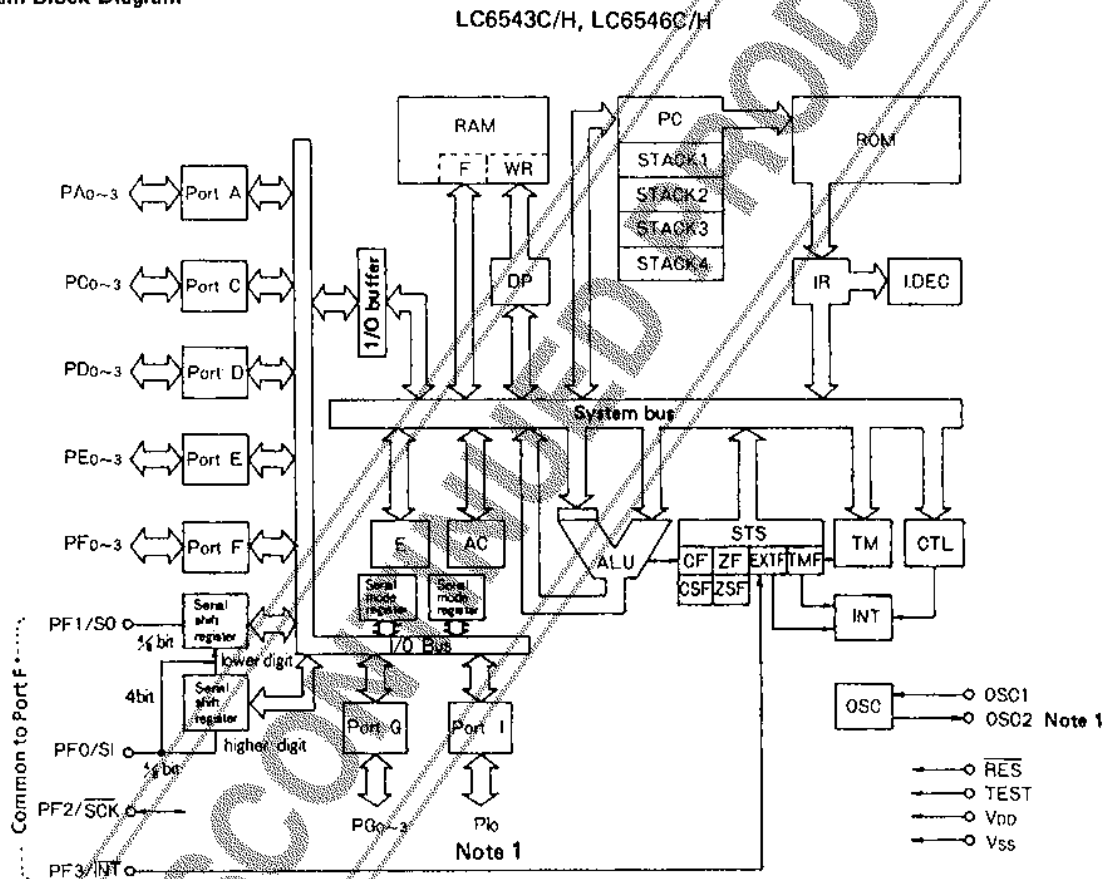

Note 1. The OSC2 pin and PI0 pin are common to each other, but are mutually exclusive. Either pin is user-selectable.

| | | | |
|-----|-----------------------------|---------|-----------------------------------|
| RAM | : Data memory | ROM | : Program memory |
| F | : Flag | PC | : Program counter |
| WR | : Working register | INT | : Interrupt control |
| AC | : Accumulator | IR | : Instruction register |
| ALU | : Arithmetic and logic unit | IDEC | : Instruction decoder |
| DP | : Data pointer | CF, CSF | : Carry flag, carry save flag |
| E | : E register | ZF, ZSF | : Zero flag, zero save flag |
| CTL | : Control register | EXTF | : External interrupt request flag |
| OSC | : Oscillator | TMF | : Internal interrupt request flag |
| TM | : Timer | | |
| STS | : Status register | | |

Development Support Tools

The following are available to support the program development for the LC6543, LC6546.

- (1) User's Manual
"LC6554 Series User's Manual" No. E21B (Issued in December, 1987)
- (2) Development Tool Manual
For the EVA-410 system, refer to the description of Development support tool in "LC6554 Series User's Manual".
For the EVA-800 system, refer to "EVA-800 · LC6554 Series Development Tool Manual".
- (3) Development Tools
 - 1) For program development (EVA-410 system)
 - i. MS-DOS for host system (Note 1)
 - ii. MS-DOS base cross assembler: < LC65S.EXE >
 - iii. Evaluation kit (EVA-410C)
 - iv. Evaluation kit target board (EVA-TB6543/46), evaluation chip (LC6594)
 - 2) For program evaluation
 - i. New piggyback (LC65PG43/46-A)
 - Small package
 - The socket for pin-to-pin conversion is not required.
 - For detailed information on how to use it, refer to page 33 of this catalog.
 - ii. Piggyback (LC65PG43/46)
 - The socket for pin-to-pin conversion is required.

Note. For notes for program evaluation, do not fail to refer to "5-3-4. Notes when evaluating programs for the LC6543/46" in "LC6554 Series User's Manual".

EVA-410 System

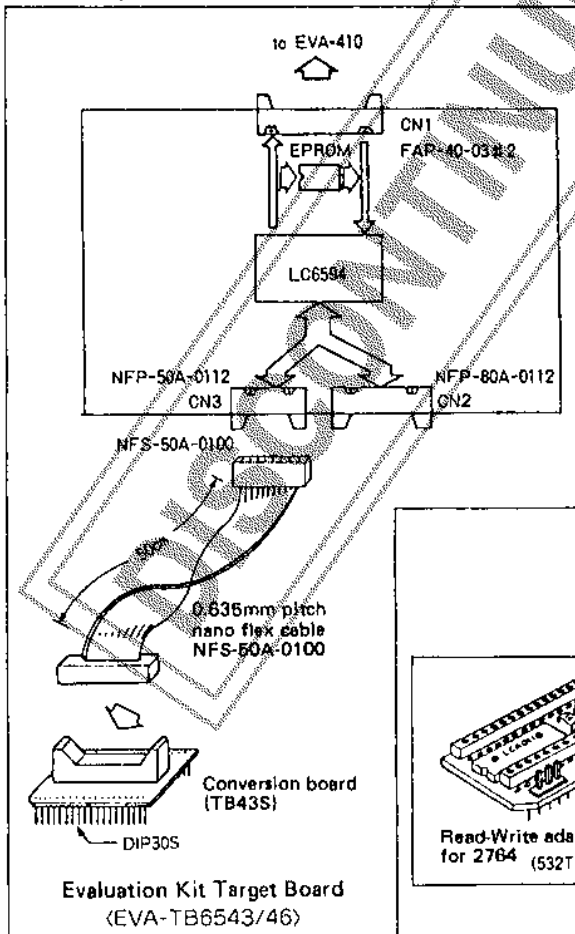

Piggyback

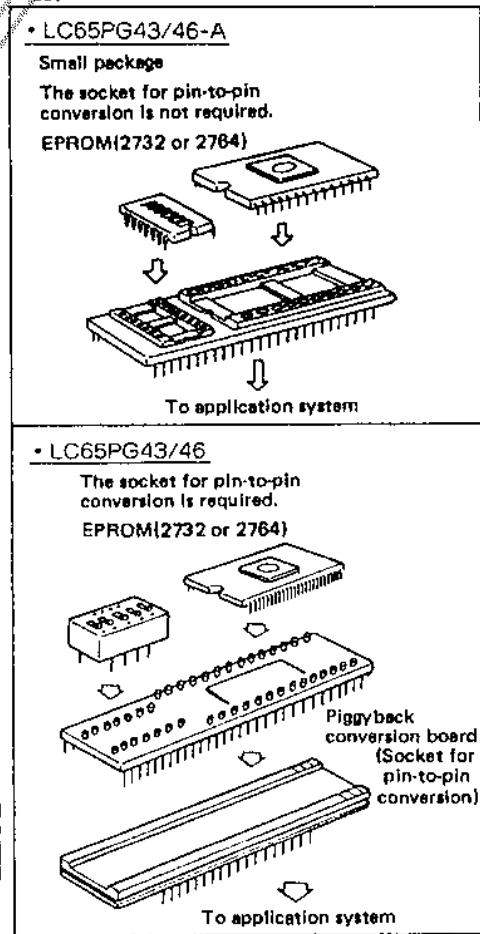

- 3) For program development (EVA-800 system)
 - i. MS-DOS personal computers compatible with IBM PC/XT and IBM PC-AT (Note 1)
 - ii. Cross assemblerMS-DOS base cross assembler: < LC65S.EXE >
 - iii. Host processor control program
 - iv. Evaluation chip: LC6594
 - v. Emulator : EVA-850 or EVA-800 emulator and evaluation boards

Appearance of Development Support System

EVA-800 System

- Host processor control program
- LC65S.EXE cross assembler

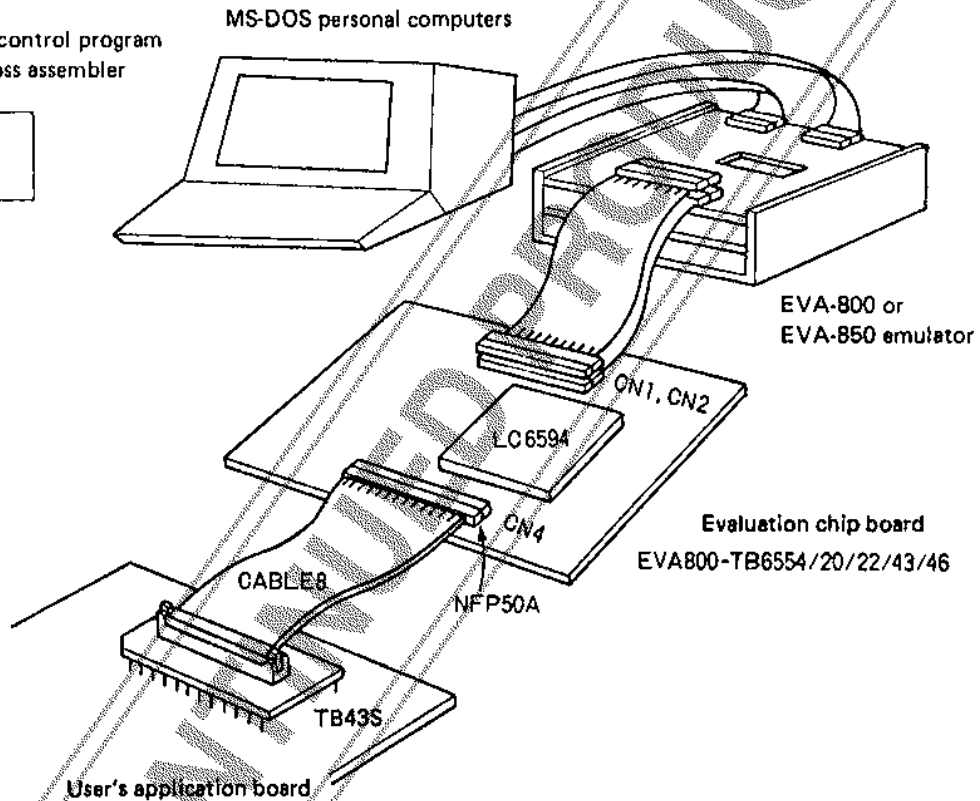

(Note 1) IBM PC/XT, IBM PC-AT: Products of IBM Corporation

MS-DOS: Trademark of Microsoft Corporation

(Note 2) The EVA-800 is a general term for emulator. A suffix (A, B, ...) is added at the end of EVA-800 as the EVA-800 is improved to be a newer version. Do not use the EVA-800 with no suffix added.

Pin Description

| Pin Name | Pins | I/O | Function | Option | When in the Reset Mode |
|--------------------------|--------|--------------|--|---|--|
| VDD VSS | 1 1 | -- -- | Power supply | -- | -- |
| OSC1 | 1 | Input | <ul style="list-style-type: none"> Pin for externally connecting C, RC, ceramic resonator for system clock generation. For 1-pin external clock input, 1-pin C OSC, the PI0/OSC2 pin is used as I/O port PI0 For 2-pin RC OSC, 2-pin ceramic resonator OSC, the PI0/OSC2 pin is used as OSC pin OSC2. | <ol style="list-style-type: none"> 1-pin external clock input 1-pin C OSC 2-pin RC OSC 2-pin ceramic resonator OSC Predivider option <ol style="list-style-type: none"> 1. No predivider 2. 1/3 predivider 3. 1/4 predivider | |
| PA0 PA1 PA2 PA3 | 4 | Input/output | <ul style="list-style-type: none"> I/O port A0 to 3. 4-bit input (IP instruction) 4-bit output (OP instruction) Single-bit decision (BP, BNP instruction) Single-bit set/reset (SPB, RPB instruction) Standby is controlled by PA3 (or PA0 to 3). The PA3 (or PA0 to 3) pin must be free from chattering during the HALT instruction execution cycle. | <ol style="list-style-type: none"> Open drain type output With pull-up resistor 1), 2): Specified bit by bit | <ul style="list-style-type: none"> "H" output (Output Nch transistor: OFF) |
| PC0 PC1 PC2 PC3 | 4 | Input/output | <ul style="list-style-type: none"> I/O port C0 to 3 Same as for PA0 to 3 (Note) Option permits output at the reset mode to be "H" or "L". (Note) No standby control function is provided. | <ol style="list-style-type: none"> Open drain type output With pull-up resistor Output at the reset mode: "H" Output at the reset mode: "L" <ul style="list-style-type: none"> 1), 2): Specified bit by bit 3), 4): Specified in a group of 4 bits | <ul style="list-style-type: none"> "H" output "L" output (Option-selectable) |
| PD0 PD1 PD2 PD3 | 4 | Input/output | <ul style="list-style-type: none"> I/O port D0 to 3 Same as for PC0 to 3 | Same as for PC0 to 3 | Same as for PC0 to 3 |
| PE0 PE1 PE2 PE3 | 4 | Input/output | <ul style="list-style-type: none"> I/O port E0 to 3 4-bit input (IP instruction) 4-bit output (OP instruction) Single-bit decision (BP, BNP instruction) Single-bit set/reset (SPB, RPB instruction) PE0: With burst pulse (64T_{CYC}) output function | <ol style="list-style-type: none"> Open drain type output With pull-up resistor 1), 2): Specified bit by bit | <ul style="list-style-type: none"> "H" output (Output Nch transistor OFF) |

LC6543C, 6543H, 6546C, 6546H

| Pin Name | Pins | I/O | Function | Option | When in the Reset Mode |
|--|------|-----------------------------|---|----------------------------------|---|
| PF ₀ /SI PF ₁ /SO PF ₂ /SCK PF ₃ /INT | 4 | Input/ output | <ul style="list-style-type: none"> I/O port F₀ to 3 Same as for PE₀ to 3 (Note) PF₀ to 3: Common with serial interface, INT input. <p>Program-selectable</p> <p>SI ---- Serial input port SO ---- Serial output port SCK--Serial clock Input/output INT---Interrupt request input</p> <p>4-bit/8-bit serial input/output is program-selectable.</p> <p>(Note) No burst pulse output function is provided.</p> | Same as for PE ₀ to 3 | Same as for PE ₀ to 3 Serial port: Disable Interrupt source: INT |
| PG ₀ PG ₁ PG ₂ PG ₃ | 4 | Input/ output | <ul style="list-style-type: none"> I/O port G₀ to 3 Same as for PE₀ to 3 (Note) <p>(Note) No burst pulse output function is provided.</p> | Same as for PE ₀ to 3 | Same as for PE ₀ to 3 |
| PI ₀ /OSC2 | 1 | Input- output/ output | <ul style="list-style-type: none"> I/O port I₀ Same as for PG₀ to 3 Single-bit configuration For 2-pin OSC, this pin is used as the OSC2 pin, providing no function as I/O port. | Same as for PG ₀ to 3 | Same as for PG ₀ to 3 |
| RES | 1 | Input | <ul style="list-style-type: none"> System reset input For power-up reset, C is connected externally For reset restart, "L" level is applied for 4 clock cycles or more. | | |
| TEST | 1 | Input | <ul style="list-style-type: none"> LSI test pin Normally connected to VSS | | |

DISCONTINUED PRODUCT

Oscillator Circuit Option

| Option Name | Circuit | Conditions, etc. |
|--------------------------|---------|--|
| 1. 1-pin C OSC | | The P10/OSC2 pin is used as port P10. |
| 2. External clock | | The P10/OSC2 pin is used as port P10. |
| 3. 2-pin RC OSC | | The P10/OSC2 pin is used as OSC pin OSC2, providing no function as port. |
| 4. Ceramic resonator OSC | | The P10/OSC2 pin is used as OSC pin OSC2, providing no function as port. |

Predivider Option

| Option Name | Circuit | Conditions, etc. |
|------------------------|---------|---|
| 1. No predivider (1/1) | | <ul style="list-style-type: none"> ● Applicable to all of 4 OSC options. ● The OSC frequency, external clock do not exceed 1444kHz. (LC6543C, 6546C) ● The OSC frequency, external clock do not exceed 4330kHz (LC6543H, 6546H). |
| 2. 1/3 predivider | | <ul style="list-style-type: none"> ● Applicable to only 2 options of external clock, ceramic resonator OSC. ● The OSC frequency, external clock do not exceed 4330kHz. |
| 3. 1/4 predivider | | <ul style="list-style-type: none"> ● Applicable to only 2 options of external clock, ceramic resonator OSC. ● The OSC frequency, external clock do not exceed 4330kHz. |

LC6543C, 6543H, 6546C, 6546H

Note: The OSC option and predivider option are summarized below. Full care must be exercised.

Table of OSC, Predivider Option of LC6543C/46C,43H/46H

LC6543C, LC6546C

| Circuit Configuration | Frequency | Predivider Option (Cycle Time) | VDD Range | Remarks |
|---|--|--------------------------------|------------------------------|-----------------------------------|
| Ceramic resonator OSC | 400kHz | 1/1 (10 μ s) | 3 to 6V | Unusable with 1/3, 1/4 predivider |
| | 800kHz | 1/1 (5 μ s) | 4 to 6V | |
| | | 1/3 (15 μ s) | 4 to 6V | |
| | | 1/4 (20 μ s) | 4 to 6V | |
| 1MHz | 1/1 (4 μ s) | 4 to 6V | | |
| | 1/3 (12 μ s) | 4 to 6V | | |
| | 1/4 (16 μ s) | 4 to 6V | | |
| 4MHz | 1/3 (3 μ s) | 4 to 6V | Unusable with 1/1 predivider | |
| | | 4 to 6V | | |
| | 1/4 (4 μ s) | 4 to 6V | | |
| | | 4 to 6V | | |
| 1-pin external clock | 200k to 667kHz | 1/1 (20 to 6 μ s) | 3 to 6V | |
| | 600k to 2000kHz | 1/3 (20 to 6 μ s) | 3 to 6V | |
| | 800k to 2667kHz | 1/4 (20 to 6 μ s) | 3 to 6V | |
| | 200k to 1444kHz | 1/1 (20 to 2.77 μ s) | 4 to 6V | |
| | 600k to 4330kHz | 1/3 (20 to 2.77 μ s) | 4 to 6V | |
| | 800k to 4330kHz | 1/4 (20 to 3.70 μ s) | 4 to 6V | |
| External clock by 2-pin RC OSC circuit | Same as above | | | |
| 1-pin C | Used with 1/1 predivider, recommended constants | | 4 to 6V | |
| | If used with other than recommended constants, the frequency, predivider option, VDD range must be the same as for 1/pin external clock. | | | |
| 2-pin RC | Same as above | | 3 to 6V | |
| | | | 4 to 6V | |
| External clock input to the ceramic oscillation circuit | The ceramic oscillation circuit cannot be driven by external clock. To drive the circuit with external clock, select the external clock option or the 2-pin RC option. | | | |

LC6543H, LC6546H

| Circuit Configuration | Frequency | Predivider Option (Cycle Time) | VDD Range | Remarks |
|---|---|--------------------------------|-----------|---------|
| Ceramic resonator OSC | 4MHz | 1/1 (1 μ s) | 4.5 to 6V | |
| 1-pin external clock | 200k to 4330kHz | 1/1 (20 to 0.92 μ s) | 4.5 to 6V | |
| External clock by ceramic resonator OSC circuit | The ceramic oscillation circuit cannot be driven by external clock. To drive the circuit with external clock, select the external clock option. | | | |

Option of Ports C, D Output Level at the Reset Mode

For input/output common ports C, D, either of the following two output levels may be selected in a group of 4 bits during reset by option.

| Option Name | Conditions, etc. |
|--|-----------------------------|
| 1. Output at the reset mode: "H" level | All of 4 bits of ports C, D |
| 2. Output at the reset mode: "L" level | All of 4 bits of ports C, D |

Option of Port Output Configuration

For each input/output common port, either of the following two output configurations may be selected by option (Bitwise).

| Option Name | Circuit | Conditions, etc. |
|---------------------------------|---------|---|
| 1. Open drain output | | <ul style="list-style-type: none"> • Unapplicable to port P10/OSC2 when 2-pin RC OSC or ceramic resonator OSC is selected. |
| 2. Output with pull-up resistor | | |

LC6543C, 6546C

1. Absolute Maximum Ratings at Ta=25°C, VSS=0V

| | | | | unit |
|-----------------------------|--------------------|--|-----------------------------------|------|
| Maximum Supply Voltage | VDD max | VDD | -0.3 to +7.0 | V |
| Output Voltage | VO | OSC2 | Allowable up to voltage generated | V |
| Input Voltage | VI(1) VI(2) | OSC1 (*1) TEST, RES | -0.3 to VDD+0.3 | V |
| Input/Output Voltage | VI(O(1) VI(O(2) | Port of OD type Port of PU type OSC1 for 1-pin C OSC | -0.3 to +15 | V |
| Peak Output Current | IOP | I/O port | -2 to +20 | mA |
| Average Output Current | IOA | Per pin over the period of 100msec. I/O port | -2 to +20 | mA |
| | ΣIOA(1) | Total current of PC0 to 3, PD0 to 3, PE0 to 3 (*2) | -15 to +100 | mA |
| | ΣIOA(2) | Total current of PF0 to 3, PG0 to 3, PA0 to 3, PI0 (*2) | -15 to +100 | mA |
| Allowable Power Dissipation | Pd max (1) | Ta=-30 to +70°C (DIP package) | 400 | mW |
| | Pd max (2) | Ta=-30 to +70°C (MFP package) | 200 | mW |
| Operating Temperature | Topg | | -30 to +70 | °C |
| Storage Temperature | Tstg | | -55 to +125 | °C |

LC6543C, 6546C

| 2. Allowable Operating Conditions at Ta=-30 to +70°C, VSS=0V, VDD=3.0 to 6.0V | | | | min | typ | max | unit | |
|---|----------------------------------|--|---|--------------------------|-------|---------------------|--------|------|
| Operating Supply Voltage | VDD | | VDD | 3.0 | | 6.0 | V | |
| Standby Supply Voltage | Vst | RAM, register hold (*3) | VDD | 1.8 | | 6.0 | V | |
| "H"-Level Input Voltage | V _{IH} (1) | Output Nch Tr OFF | Port of OD type (except I _O) | 0.7V _{DD} | | +13.5 | V | |
| | V _{IH} (2) | Output Nch Tr OFF | Port of PU type (except I _O) | 0.7V _{DD} | | V _{DD} | V | |
| | V _{IH} (3) | Output Nch Tr OFF | INT, SCK, SI | 0.8V _{DD} | | +13.5 | V | |
| | V _{IH} (4) | Output Nch Tr OFF | I _O of OD type | 0.8V _{DD} | | V _{DD} | V | |
| | V _{IH} (5) | | INT, SCK, SI | 0.8V _{DD} | | V _{DD} | V | |
| | V _{IH} (6) | External clock mode | I _O of PU type | 0.8V _{DD} | | V _{DD} | V | |
| | V _{IH} (7) | | RES | 0.8V _{DD} | | V _{DD} | V | |
| | V _{IH} (8) | | OSC1 | 0.8V _{DD} | | V _{DD} | V | |
| | V _{IL} (1) | Output Nch Tr OFF | V _{DD} =4 to 6V, Port | V _{SS} | | 0.3V _{DD} | V | |
| | V _{IL} (2) | Output Nch Tr OFF | Port | V _{SS} | | 0.25V _{DD} | V | |
| "L"-Level Input Voltage | V _{IL} (3) | Output Nch Tr OFF | V _{DD} =4 to 6V, INT, SCK, SI | V _{SS} | | 0.25V _{DD} | V | |
| | V _{IL} (4) | Output Nch Tr OFF | INT, SCK, SI | V _{SS} | | 0.2V _{DD} | V | |
| | V _{IL} (5) | External clock mode | V _{DD} =4 to 6V, OSC1 | V _{SS} | | 0.25V _{DD} | V | |
| | V _{IL} (6) | External clock mode | OSC1 | V _{SS} | | 0.2V _{DD} | V | |
| | V _{IL} (7) | | V _{DD} =4 to 6V, TEST | V _{SS} | | 0.3V _{DD} | V | |
| | V _{IL} (8) | | TEST | V _{SS} | | 0.25V _{DD} | V | |
| | V _{IL} (9) | | V _{DD} =4 to 6V, RES | V _{SS} | | 0.25V _{DD} | V | |
| | V _{IL} (10) | | RES | V _{SS} | | 0.2V _{DD} | V | |
| | Operating Frequency (Cycle Time) | f _{op} | When the 1/3 or 1/4 predivider option is selected, clock must not exceed 4.33MHz. | V _{DD} =4 to 6V | 200 | | 1444 | kHz |
| | | (TCYC) | | | (20) | | (2.77) | (μs) |
| External Clock Conditions Frequency | f _{ext} | | V _{DD} =4 to 6V, OSC1 | 200 | | 4330 | kHz | |
| | | Fig. 1. When clock exceeds 1.444MHz, the 1/3 or 1/4 predivider option is selected. | | 200 | | 667 | kHz | |
| Pulse Width | t _{exth} | | V _{DD} =4 to 6V, OSC1 | 69 | | | ns | |
| | t _{extl} | | 180 | | | | ns | |
| Rise/Fall Time | t _{extR} | | V _{DD} =4 to 6V, OSC1 | | | 50 | ns | |
| | t _{extF} | | | | | 100 | ns | |
| Oscillation Guaranteed Constants | | | | | | | | |
| 1-pin C Oscillation | C _O | Fig. 2 | V _{DD} =4 to 6V, OSC1 | | | 180±5% | pF | |
| 2-pin RC Oscillation | C _{ext} | Fig. 3 | OSC1, OSC2 | | | 270±5% | pF | |
| | R _{ext} | Fig. 3 | OSC1, OSC2 | | | 12±1% | kohm | |
| | C _{ext} | Fig. 3 | V _{DD} =4 to 6V, OSC1, OSC2 | | | 270±5% | pF | |
| | R _{ext} | Fig. 3 | V _{DD} =4 to 6V, OSC1, OSC2 | | | 4.7±1% | kohm | |
| Ceramic Resonator Oscillation | | | | | | | | |
| | | Fig. 4 | | | | Table 1 | | |
| 3. Electrical Characteristics at Ta=-30 to +70°C, VSS=0V, VDD=3.0 to 6.0V | | | | min | typ | max | unit | |
| "H"-Level Input Current | I _{IH} (1) | Output Nch Tr OFF (including OFF leak current of Nch Tr) | Port of OD type | | | +5.0 | μA | |
| | | | V _{IN} =+13.5V | | | | | |
| | I _{IH} (2) | External clock mode, V _{IN} =V _{DD} | OSC1 | | | +1.0 | μA | |
| "L"-Level Input Current | I _{IL} (1) | Output Nch Tr OFF | Port of OD type | -1.0 | | | μA | |
| | | | V _{IN} =V _{SS} | | | | | |
| | I _{IL} (2) | Output Nch Tr OFF | Port of PU type | -1.3 | -0.35 | | mA | |
| | | | V _{IN} =V _{SS} | | | | | |

Continued on next page.

LC6543C, 6543H, 6546C, 6546H

Continued from preceding page.

LC6543C, 6546C

| | | | | min | typ | max | unit |
|------------------------------------|-------------------------|---|---|----------------------|--------------------|------|------|
| | I _{IL} (3) | V _{IN} =V _{SS} | $\overline{\text{RES}}$ | -45 | -10 | | μA |
| | I _{IL} (4) | External clock mode, V _{IN} =V _{SS} | OSC1 | -1.0 | | | μA |
| "H"-Level Output Voltage | V _{OH} (1) | I _{OH} =-50μA, V _{DD} =4.0 to 6.0V | Port of PU type | V _{DD} -1.2 | | | V |
| | V _{OH} (2) | I _{OH} =-10μA | Port of PU type | V _{DD} -0.5 | | | V |
| "L"-Level Output Voltage | V _{OL} (1) | I _{OL} =10mA, V _{DD} =4.0 to 6.0V | Port | | | 1.5 | V |
| | V _{OL} (2) | I _{OL} =1mA, I _{OL} of each port: 1mA or less | Port | | | 0.5 | V |
| Hysteresis Voltage | V _{HYS} | | $\overline{\text{RES}}$, $\overline{\text{INT}}$, $\overline{\text{SCK}}$, SI, OSC1 of Schmitt type (*6) | | 0.1V _{DD} | | V |
| Current Dissipation | | | | | | | |
| 1-Pin C Oscillation | I _{DDOP} (1) | Fig. 2 f _{OSC} =600kHz (TYP) | V _{DD} =4 to 6V, V _{DD} | | 1.5 | 5 | mA |
| 2-Pin RC Oscillation | I _{DDOP} (2) | Fig. 3 f _{OSC} =750kHz (TYP) | V _{DD} =4 to 6V, V _{DD} | | 1.5 | 5 | mA |
| | I _{DDOP} (3) | Fig. 3 f _{OSC} =350kHz (TYP) | V _{DD} | | 1.0 | 4 | mA |
| Ceramic Resonator Oscillation | I _{DDOP} (4) | Fig. 4 4MHz, 1/3 predivider | V _{DD} =4 to 6V, V _{DD} | | 2.5 | 8 | mA |
| | I _{DDOP} (5) | Fig. 4 4MHz, 1/4 predivider | V _{DD} =4 to 6V, V _{DD} | | 2.0 | 6 | mA |
| | I _{DDOP} (6) | Fig. 4 400kHz | V _{DD} | | 0.5 | 2 | mA |
| | I _{DDOP} (7) | Fig. 4 800kHz | V _{DD} =4 to 6V, V _{DD} | | 1.5 | 4 | mA |
| External Clock | I _{DDOP} (8) | 200kHz to 667kHz, 1/1 predivider | V _{DD} | | 1.5 | 5 | mA |
| | I _{DDOP} (9) | 600kHz to 2000kHz, 1/3 predivider 800kHz to 2667kHz, 1/4 predivider 200kHz to 1444kHz, 1/1 predivider 600kHz to 4330kHz, 1/3 predivider 800kHz to 4330kHz, 1/4 predivider | V _{DD} =4 to 6V, V _{DD} | | 2.5 | 8 | mA |
| Standby Mode | I _{DDSt} | Output Nch Tr OFF, Port=V _{DD} | V _{DD} =6V, V _{DD} | | 0.05 | 10 | μA |
| | | | V _{DD} =3V, V _{DD} | | 0.025 | 5 | μA |
| Oscillation Characteristics | | | | | | | |
| Ceramic Resonator Oscillation | | | | | | | |
| Oscillation Frequency | f _{CFOSC} (*4) | Fig. 4, fo=400kHz | OSC1, OSC2 | 384 | 400 | 416 | kHz |
| | | Fig. 4, fo=800kHz | V _{DD} =4 to 6V, OSC1, OSC2 | 768 | 800 | 832 | kHz |
| | | Fig. 4, fo=1MHz | V _{DD} =4 to 6V, OSC1, OSC2 | 960 | 1000 | 1040 | kHz |
| | | Fig. 4, fo=4MHz, 1/3 predivider, 1/4 predivider | V _{DD} =4 to 6V, OSC1, OSC2 | 3840 | 4000 | 4160 | kHz |
| Oscillation Stabilizing Period | t _{CFS} | Fig. 5, fo=400kHz | | | | 10 | ms |
| | | Fig. 5, fo=800kHz, V _{DD} =4 to 6V 1MHz, 4MHz, 1/3 predivider, 1/4 predivider | | | | 10 | ms |
| 1-Pin C OSC Oscillation Frequency | f _{COSC} | Fig. 2, C _o =180pF±5% | V _{DD} =4 to 6V, OSC1 | 310 | 600 | 1141 | kHz |
| 2-Pin RC OSC Oscillation Frequency | f _{MOSC} | Fig. 3, C _{ext} =270pF±5% | V _{DD} =4 to 6V, OSC1, OSC2 | 612 | 850 | 1159 | kHz |
| | | Fig. 3, R _{ext} =4.7kohms±1% | | | | | |
| | | Fig. 3, C _{ext} =270pF±5% Fig. 3, R _{ext} =12kohms±1% | OSC1, OSC2 | 275 | 400 | 642 | kHz |

Continued on next page.

Continued from preceding page.

LC6543C, 6546C

| | | | | min | typ | max | unit |
|---------------------------------------|-----------------------------|--|--------------------------------------|-----------------------------|---|-----|------|
| Pull-up/Pull-down Resistance | | | | | | | |
| I/O Port Pull-up Resistance | Rpp | | V _{DD} =5V, Port of PU type | | 14 | | kohm |
| External Reset Characteristics | | | | | | | |
| Reset Time | t _{TRST} | | | | See Fig. 6. | | |
| Pin Capacitance | C _p | f=1MHz, Other than pins to be tested, V _{IN} =V _{SS} | | | 10 | | pF |
| Serial Clock | | | | | | | |
| Input Clock Cycle Time | t _{CKCY(1)} Fig. 7 | | V _{DD} =4 to 6V | $\overline{\text{SCK}}$ 3.0 | | | μs |
| | | | | SCK 12.0 | | | μs |
| Output Clock Cycle Time | t _{CKCY(2)} Fig. 7 | | | $\overline{\text{SCK}}$ | 64 x T _{CYC} | | μs |
| | | | | | (T _{CYC} =4xSystem clock period) | | |
| Input Clock "L"-Level Pulse Width | t _{CKL(1)} Fig. 7 | | V _{DD} =4 to 6V | $\overline{\text{SCK}}$ 1.0 | | | μs |
| | | | | SCK 4.0 | | | μs |
| Output Clock "L"-Level Pulse Width | t _{CKL(2)} Fig. 7 | | | $\overline{\text{SCK}}$ | 32 x T _{CYC} | | μs |
| Input Clock "H"-Level Pulse Width | t _{CKH(1)} Fig. 7 | | V _{DD} =4 to 6V | $\overline{\text{SCK}}$ 1.0 | | | μs |
| | | | | SCK 4.0 | | | μs |
| Output Clock "H"-Level Pulse Width | t _{CKH(2)} Fig. 7 | | | $\overline{\text{SCK}}$ | 32 x T _{CYC} | | μs |
| Serial Input | | | | | | | |
| Data Setup Time | t _{ICK} | Specified for ↑ of $\overline{\text{SCK}}$ | | SI | 0.5 | | μs |
| Data Hold Time | t _{CKI} | Fig. 7 | | SI | 0.5 | | μs |
| Serial Output | | | | | | | |
| Output Delay Time | t _{CKO} | Specified for ↓ of $\overline{\text{SCK}}$ | V _{DD} =4 to 6V | SO | | 0.5 | μs |
| | | Nch OD only, External 1kohm, external 50pF, Fig. 7 | | SO | | 2.0 | μs |
| Pulse Output | | | | | | | |
| Period | t _{PCY} | Fig. 8 | | PE ₀ | 64 x T _{CYC} | | μs |
| "H"-Level Pulse Width | t _{PH} | T _{CYC} =4 x System clock period | | PE ₀ | 32 x T _{CYC} ±10% | | μs |
| "L"-Level Pulse Width | t _{PL} | Nch OD only, External 1kohm, External 50pF | | PE ₀ | 32 x T _{CYC} ±10% | | μs |

- (*1) When oscillated internally under the oscillating conditions in Fig. 4, up to the oscillation amplitude generated is allowable.
- (*2) Average over the period of 100msec.
- (*3) Operating supply voltage V_{DD} must be held until the standby mode is entered after the execution of the HALT instruction. The PA₃ (or PA₀ to 3) pin must be free from chattering during the HALT instruction execution cycle.
- (*4) f_{CFOSC}: Oscillatable frequency. There is a tolerance of approximately 1% between the center frequency at the ceramic resonator mode and the nominal value presented by the ceramic resonator supplier. For details, refer to the specification for the ceramic resonator.
- (*5) When mounting the MFP version on the board, do not dip it in solder.
- (*6) The OSC1 pin can be schmitt-triggered when the 1-pin oscillation option, 2-pins oscillation option, or external clock oscillation option has been selected.

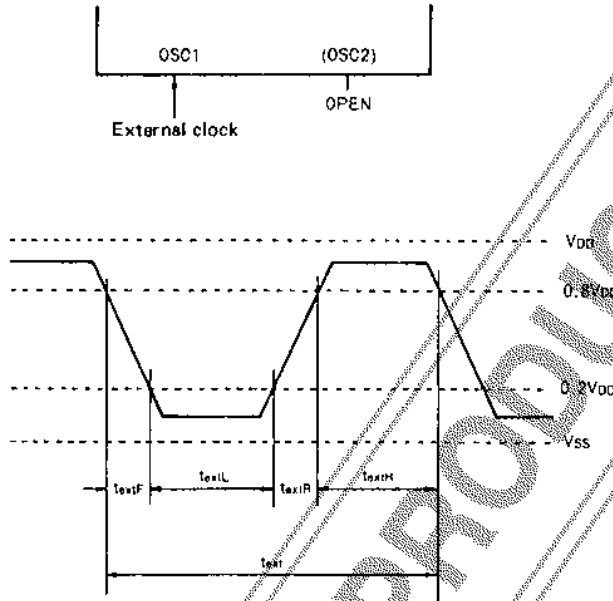

Fig. 1 External Clock Input Waveform

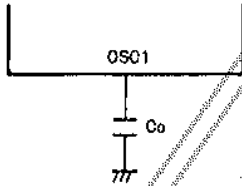

Fig. 2 1-Pin C Oscillation Circuit

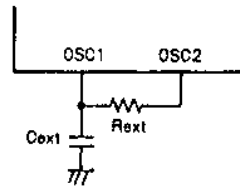

Fig. 3 2-Pin RC Oscillation Circuit

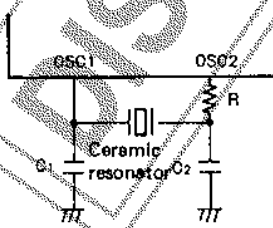

Fig. 4 Ceramic Resonator Oscillation Circuit

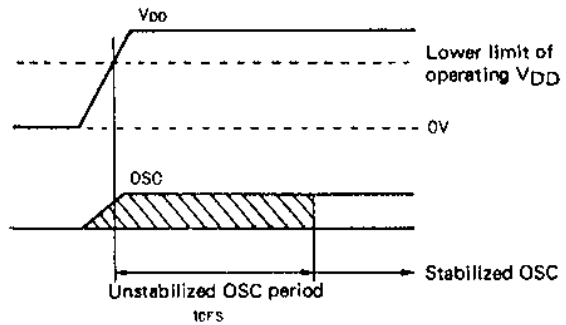

Fig. 5 Oscillation Stabilizing Period

| | | |
|---|----|-------------|
| 4 MHz CSA4.00MG (Murata) | C1 | 33pF ± 10% |
| | C2 | 33pF ± 10% |
| | R | 0 Ω |
| 4 MHz KBR4.0MS (Kyocera) | C1 | 33pF ± 10% |
| | C2 | 33pF ± 10% |
| | R | 0 Ω |
| 1 MHz CSB1000K (Murata) CSB1000D (Murata) | C1 | 220pF ± 10% |
| | C2 | 220pF ± 10% |
| | R | 0 Ω |
| 1 MHz KBR1000H (Kyocera) | C1 | 100pF ± 10% |
| | C2 | 100pF ± 10% |
| | R | 0 Ω |
| 800KHz CSB800D (Murata) | C1 | 220pF ± 10% |
| | C2 | 220pF ± 10% |
| | R | 0 Ω |
| 800KHz KBR800H (Kyocera) | C1 | 220pF ± 10% |
| | C2 | 220pF ± 10% |
| | R | 0 Ω |
| 400KHz CSB400P (Murata) | C1 | 330pF ± 10% |
| | C2 | 330pF ± 10% |
| | R | 0 Ω |
| 400KHz KBR400B (Kyocera) | C1 | 330pF ± 10% |
| | C2 | 330pF ± 10% |
| | R | 0 Ω |

Table 1 Constants Guaranteed for Ceramic Resonator OSC

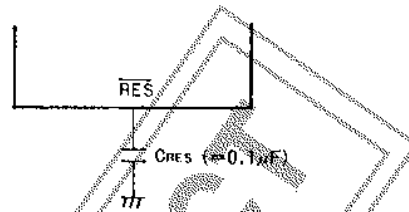

Fig. 6 Reset Circuit

(Note) When the rise time of the power supply is 0, the reset time becomes 10ms to 100ms at $C_{RES}=0.1\mu F$. If the rise time of the power supply is long, the value of C_{RES} must be increased so that the reset time becomes 10ms or more.

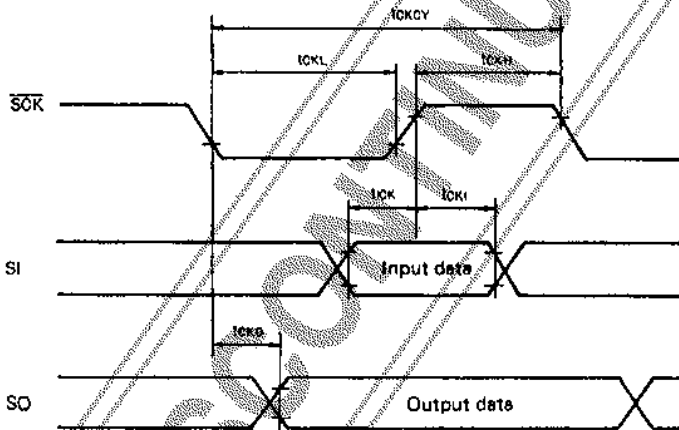
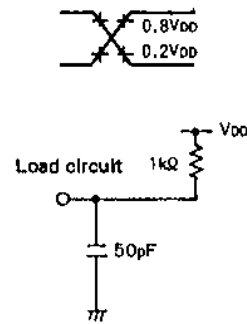

Fig. 7 Serial Input/Output Timing



The load conditions are the same as in Fig. 7.

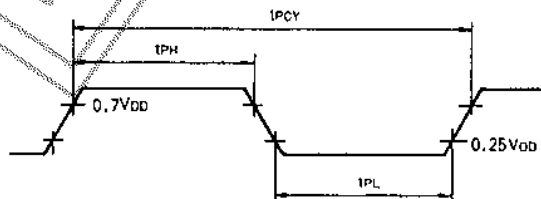

Fig. 8 Pulse Output Timing at Port PE0

RC Oscillation Characteristic of the LC6543C, 6546C

Fig. 9 shows the RC oscillation characteristic of the LC6543C, 6546C. For the variation range of RC OSC frequency of the LC6543C, 6546C, the following are guaranteed at the external constants only shown below.

- i) $V_{DD}=3.0V$ to $6.0V$, $T_a=-30^{\circ}C$ to $+70^{\circ}C$
 External constants $C_{ext}=270pF$
 $R_{ext}=12kohms$
 $275kHz \leq f_{MOSC} \leq 642kHz$
- ii) $V_{DD}=4.0V$ to $6.0V$, $T_a=-30^{\circ}C$ to $+70^{\circ}C$
 External constants $C_{ext}=270pF$
 $R_{ext}=4.7kohms$
 $612kHz \leq f_{MOSC} \leq 1159kHz$

If any other constants than specified above are used, the range of $R_{ext}=3kohms$ to $20kohms$, $C_{ext}=150pF$ to $390pF$ must be observed. (See Fig. 9.)

- (*7): The oscillation frequency at $V_{DD}=5.0V$, $T_a=25^{\circ}C$ must be in the range of $350kHz$ to $750kHz$.
- (*8): The oscillation frequency at $V_{DD}=4.0V$ to $6.0V$, $T_a=-30^{\circ}C$ to $+70^{\circ}C$ and $V_{DD}=3.0V$ to $6.0V$, $T_a=-30^{\circ}C$ to $+70^{\circ}C$ must be within the operation clock frequency range.

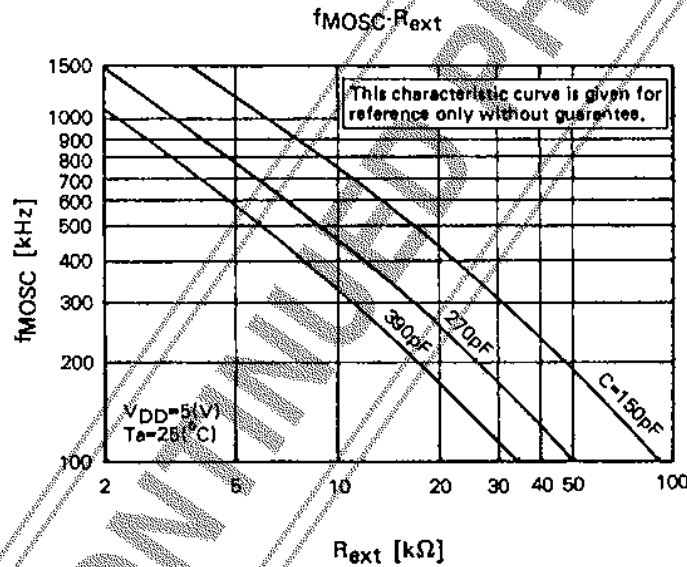

Fig. 9 RC Oscillation Frequency Data (Typ.)

LC6543H, 6546H

1. Absolute Maximum Ratings at Ta=25°C, VSS=0V

| | | | | unit |
|-----------------------------|------------|---|-----------------------------------|-------------|
| Maximum Supply Voltage | VDD max | VDD | -0.3 to +7.0 | V |
| Output Voltage | VO | OSC2 | Allowable up to voltage generated | V |
| Input Voltage | VI(1) | OSC1 (*1) | -0.3 to VDD+0.3 | V |
| | VI(2) | TEST, RES | -0.3 to VDD+0.3 | V |
| Input/Output Voltage | VIO(1) | Port of OD type | -0.3 to +15 | V |
| | VIO(2) | Port of PU type | -0.3 to VDD+0.3 | V |
| Peak Output Current | IOP | I/O port | -2 to +20 | mA |
| Average Output Current | IOA | Per pin over the period of 100msec. | I/O port | -2 to +20 |
| | ΣIOA(1) | Total current of PC0 to 3, PD0 to 3, PE0 to 3 (*2) | | -15 to +100 |
| | ΣIOA(2) | Total current of PF0 to 3, PG0 to 3, PA0 to 3, PI0 (*2) | | -15 to +100 |
| Allowable Power Dissipation | Pd max (1) | Ta=-30 to +70°C (DIP) | 400 | mW |
| | Pd max (2) | Ta=-30 to +70°C (MFP) | 200 | mW |
| Operating Temperature | Topg | | -30 to +70 | °C |
| Storage Temperature | Tstg | | -55 to +125 | °C |

2. Allowable Operating Conditions at Ta=-30 to +70°C, VSS=0V, VDD=4.5 to 5.0V

| | | | min | typ | max | unit | |
|----------------------------------|--------|------------------------|-----------------------------|--------------|---------|------|----|
| Operating Supply Voltage | VDD | VDD | 4.5 | | 6.0 | V | |
| Standby Supply Voltage | VSt | RAM, register hold(*3) | 1.8 | | 6.0 | V | |
| "H"-Level Input Voltage | VIH(1) | Output Nch Tr OFF | Port of OD type (except I0) | 0.7VDD | +13.5 | V | |
| | VIH(2) | Output Nch Tr OFF | Port of PU type (except I0) | 0.7VDD | VDD | V | |
| | VIH(3) | Output Nch Tr OFF | INT, SCK, SI, I0 of OD type | 0.8VDD | +13.5 | V | |
| | VIH(4) | Output Nch Tr OFF | INT, SCK, SI, I0 of PU type | 0.8VDD | VDD | V | |
| | VIH(5) | | RES | 0.8VDD | VDD | V | |
| | VIH(6) | External clock mode | OSC1 | 0.8VDD | VDD | V | |
| "L"-Level Input Voltage | VIL(1) | Output Nch Tr OFF | Port | VSS | 0.3VDD | V | |
| | VIL(2) | Output Nch Tr OFF | INT, SCK, SI | VSS | 0.25VDD | V | |
| | VIL(3) | External clock mode | OSC1 | VSS | 0.25VDD | V | |
| | VIL(4) | | TEST | VSS | 0.3VDD | V | |
| | VIL(5) | | RES | VSS | 0.25VDD | V | |
| Operating Frequency (Cycle Time) | fop | | 200 | | 4330 | kHz | |
| | f(CYC) | | (20) | | (0.92) | (µs) | |
| External Clock Conditions | | | | | | | |
| Frequency | fext | Fig. 1 | OSC1 | 200 | 4330 | kHz | |
| Pulse Width | textH | | OSC1 | 69 | | | ns |
| | textL | | | | | | |
| Rise/Fall Time | textR | | OSC1 | | 50 | ns | |
| | textF | | | | | | |
| Oscillation Guaranteed Constants | | | | | | | |
| Ceramic Resonator Oscillation | | Fig. 2 | | See Table 1. | | | |

(*1) When oscillated internally under the oscillating conditions in Fig. 2, up to the oscillation amplitude generated is allowable.

(*2) Average over the period of 100msec.

(*3) Operating supply voltage VDD must be held until the standby mode is entered after the execution of the HALT instruction.

The PA3 (or PA0 to 3) pin must be free from chattering during the HALT instruction execution cycle.

(*4) When mounting the MFP version on the board, do not dip it in solder.

LC6543H, 6546H

| 3. Electrical Characteristics at Ta=-30 to +70°C, VSS=0V, VDD=4.5 to 6.0V | | | | min | typ | max | unit |
|---|-----------------------|---|---|---------|-------|---|------|
| "H"-Level Input Currnt | I _{IH} (1) | Output Nch Tr OFF (including OFF leak current of Nch Tr) V _{IN} =+13.5V | Port of OD type | | | +5.0 | µA |
| | I _{IH} (2) | External clock mode, V _{IN} =VDD | OSC1 | | | +1.0 | µA |
| "L"-Level Input Current | I _{IL} (1) | Output Nch Tr OFF V _{IN} =VSS | Port of OD type | -1.0 | | | µA |
| | I _{IL} (2) | Output Nch Tr OFF V _{IN} =VSS | Port of PU type | -1.3 | -0.35 | | mA |
| | I _{IL} (3) | V _{IN} =VSS | $\overline{\text{RES}}$ | -45 | -10 | | µA |
| | I _{IL} (4) | External clock mode, V _{IN} =VSS | OSC 1 | -1.0 | | | µA |
| "H"-Level Output Voltage | V _{OH} (1) | I _{OH} =-50uA | Port of PU type | VDD-1.2 | | | V |
| | V _{OH} (2) | I _{OH} =-10uA | Port of PU type | VDD-0.5 | | | V |
| "L"-Level Output Voltage | V _{OL} (1) | I _{OL} =10mA | Port | | | 1.5 | V |
| | V _{OL} (2) | I _{OL} =1mA, I _{OL} of each port: 1mA or less | Port | | | 0.5 | V |
| Hysteresis Voltage | V _{HYS} | | $\overline{\text{RES}}$, $\overline{\text{INT}}$, $\overline{\text{SCK}}$, SI, OSC1 of Schmitt type (*5) | 0.1VDD | | | V |
| Current Dissipation | | | | | | | |
| Ceramic Resonator Oscillation | I _{DDOP} (1) | Fig. 2, 4MHz | Operating mode, VDD Output Nch Tr OFF, | | 4.0 | 10 | mA |
| External Clock | I _{DDOP} (2) | 200kHz to 4330kHz | Port=VDD VDD | | 4.0 | 10 | mA |
| Standby Mode | I _{DDSt} | Output Nch Tr OFF, Port=VDD | VDD=6V VDD VDD=3V VDD | | 0.05 | 10 | µA |
| | | | | | 0.025 | 5 | µA |
| Oscillation Characteristics | | | | | | | |
| Ceramic Resonator Oscillation | | | | | | | |
| Oscillation Frequency | f _{CFOSC} | Fig. 2, fo=4MHz (*6) | OSC1, OSC2 | 3840 | 4000 | 4160 | kHz |
| Oscillation Stabilizing Period | t _{CFSt} | Fig. 3, fo=4MHz | | | | 10 | ms |
| Pull-up/Pull-down Resistance | | | | | | | |
| I/O Port Pull-up Resistance | R _{pp} | | VDD=5V, Port of PU type | | 14 | | kohm |
| External Reset Characteristics | | | | | | | |
| Reset Time | t _{RST} | | | | | See Fig. 4. | |
| Pin Capacitance | C _p | f=1MHz, other than pins to be tested, V _{IN} =VSS | | | | 10 | pF |
| Serial Clock | | | | | | | |
| Input Clock Cycle Time | t _{CKCY} (1) | Fig. 5 | $\overline{\text{SCK}}$ | | 3.0 | | µs |
| Output Clock Cycle Time | t _{CKCY} (2) | Fig. 5 | $\overline{\text{SCK}}$ | | | 64 x T _{CYC} (T _{CYC} =4 x System clock period) | µs |
| Input Clock "L"-Level Pulse Width | t _{CKL} (1) | Fig. 5 | $\overline{\text{SCK}}$ | | 1.0 | | µs |
| Output Clock "L"-Level Pulse Width | t _{CKL} (2) | Fig. 5 | $\overline{\text{SCK}}$ | | | 32 x T _{CYC} | µs |
| Input Clock "H"-Level Pulse Width | t _{CKH} (1) | Fig. 5 | $\overline{\text{SCK}}$ | | 1.0 | | µs |
| Output Clock "H"-Level Pulse Width | t _{CKH} (2) | Fig. 5 | $\overline{\text{SCK}}$ | | | 32 x T _{CYC} | µs |

Continued on next page.

Continued from preceding page.

LC6543H, 6546H

| | | | | min | typ | max | unit |
|-----------------------|-----------|--|-----------------|------------------------------|-----|-----|---------|
| Serial Input | | | | | | | |
| Data Setup Time | t_{ICK} | Specified for \uparrow of \overline{SCK} | SI | 0.5 | | | μs |
| Data Hold Time | t_{CKI} | Fig. 5 | SI | 0.5 | | | μs |
| Serial Output | | | | | | | |
| Output Delay Time | t_{CKO} | Specified for \downarrow of \overline{SCK} Nch OD only, External 1kohm, external 50pF, Fig. 5 | SO | | | 0.5 | μs |
| Pulse Output | | | | | | | |
| Period | t_{PCY} | Fig. 6 | PE ₀ | $64 \times T_{CYC}$ | | | μs |
| "H"-Level Pulse Width | t_{PH} | $T_{CYC} = 4 \times$ System clock period, Nch OD only, | PE ₀ | $32 \times T_{CYC} \pm 10\%$ | | | μs |
| "L"-Level Pulse Width | t_{PL} | External 1kohm, External 50pF | PE ₀ | $32 \times T_{CYC} \pm 10\%$ | | | μs |

(*5) The OSC1 pin can be schmitt-triggered when the external clock oscillation option has been selected.

(*6) f_{CFOSC} : Oscillatable frequency

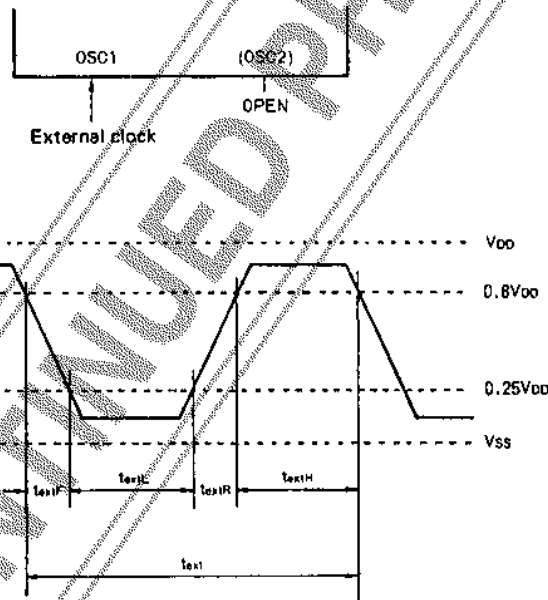

Fig. 1 External Clock Input Waveform

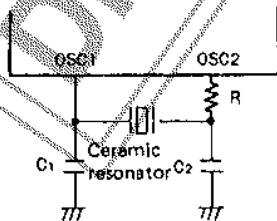

Fig. 2 Ceramic Resonator Oscillation Circuit

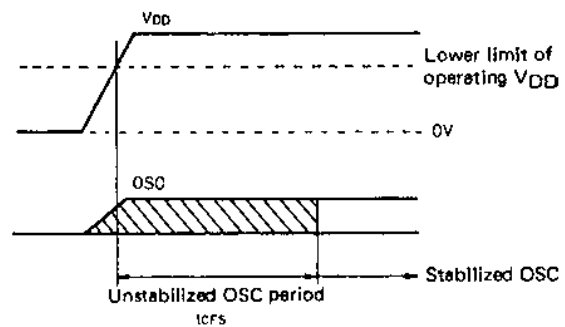

Fig. 3 Oscillation Stabilizing Period

| | | |
|-----------------------------|----|------------|
| 4 MHz CSA4.00MG (Murata) | C1 | 33PF ± 10% |
| | C2 | 33PF ± 10% |
| | R | 0 Ω |
| 4 MHz KBR4.0MS (Kyocera) | C1 | 33PF ± 10% |
| | C2 | 33PF ± 10% |
| | R | 0 Ω |

Table 1 Constants Guaranteed for Ceramic Resonator OSC

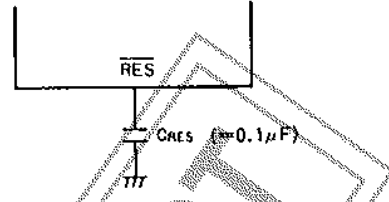

Fig. 4 Reset Circuit

(Note) When the rise time of the power supply is 0, the reset time becomes 10ms to 100ms at $C_{RES}=0.1\mu F$. If the rise time of the power supply is long, the value of C_{RES} must be increased so that the reset time becomes 10ms or more.

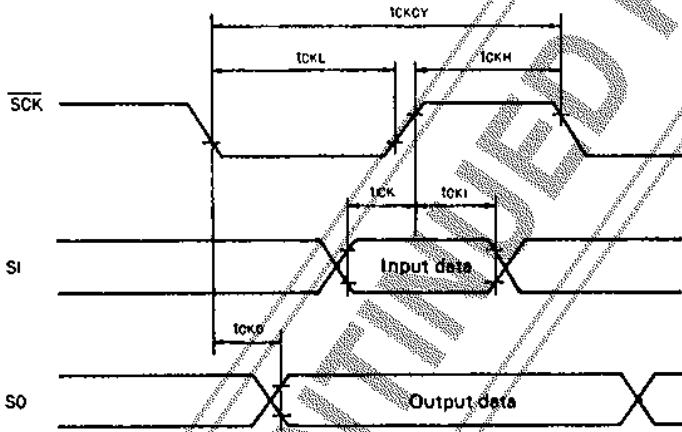
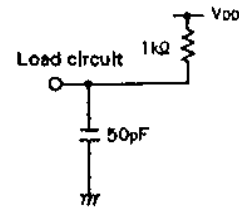
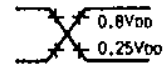

Fig. 5 Serial Input/Output Timing



The load conditions are the same as in Fig. 5.

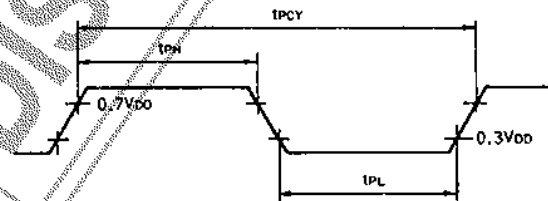

Fig. 6 Pulse Output Timing at Port PEQ

Notes for Standby Function Application

The LC6543/46 provide the standby function called HALT mode to minimize the current dissipation when the program is in the wait state.

The standby function is controlled by the HALT instruction, PA pin, $\overline{\text{RES}}$ pin, and serial transfer completion signal. A peripheral circuit and program must be so designed as to provide precise control of the standby function. In most applications where the standby function is performed, voltage regulation, instantaneous break of power, and external noise are not negligible. When designing an application circuit and program, whether or not to take some measures must be considered according to the extent to which these factors are allowed. This section mainly describes power failure backup for which the standby function is mostly used. A sample application circuit where the standby function is performed precisely is shown below and notes for circuit design and program design are also given below.

When using the standby function, the application circuit shown below must be used and the notes must be also fully observed.

If any other method than shown in this section is applied, it is necessary to fully check the environmental conditions such as power failure and the actual operation of application equipment.

1. HALT mode release conditions

1-1. Supplementary description of release by serial transfer completion signal.

On completion of serial transfer, the HALT mode is released and the execution of the program starts with an instruction immediately following the HALT instruction. This function can be used to execute the program only when serial transfer occurs, placing the program in the wait state when no serial transfer occurs. This function is effective in reducing the current dissipation or clock noise.

– Notes –

- Release by the serial transfer completion signal is available only when the RC mode is used for system clock generation; and unavailable when the ceramic resonator mode is used.
- On completion of serial transfer, the HALT mode is released unconditionally. In an application, such as capacitor backup application, where the current dissipation must be kept as low as possible during backup and serial transfer by external clock is also used, the HALT mode is released when serial data is transferred externally during backup.

1-2. Summary of HALT release conditions

The HALT mode setting, release conditions are shown in Table 1.

Table 1 HALT mode setting, release conditions

| HALT mode setting conditions | HALT mode release conditions |
|---|---|
| HALT Instruction Provided that PA ₃ (PA ₃ to PA ₀ or PA ₃ is program-selectable) is at high level. | 1 Reset (Low level is applied to $\overline{\text{RES}}$.) 2 Low level is applied to PA ₃ (PA ₃ to PA ₀ or PA ₃ is program-selectable.) 3 Serial transfer completion. |

Note) HALT mode release conditions 2, 3 are available only when the RC mode is used for system clock generation; and unavailable when the ceramic resonator mode is used.

2. Proper cares in using standby function

When using the standby function, an application circuit and program must be designed with the following in mind.

- (1) The supply voltage at the standby state must not be less than specified.
- (2) Input timing and conditions of each control signal ($\overline{\text{RES}}$, port A, serial transfer) must be observed at the standby initiate/release state.
- (3) Release operation must not be overlapped at the time of execution of the HALT instruction.

A sample application where the standby function is used for power failure backup is shown below as a concrete method to observe these notes. A sample application circuit, its operation, and notes for program design are given below.

Sample application where the standby function is used for power failure backup

Power failure backup is an application where power failure of the main power source is detected and the HALT instruction is executed to cause the standby state to be entered. The current dissipation is minimized and a backup capacitor is used to retain the contents of the internal registers for a certain period of time. After power is restored, a reset occurs automatically and the execution of the program starts at address 000H of the program counter (PC). Shown below are sample applications where the program selects or not between power-ON reset and reset after power is restored, notes, measures for instantaneous break of AC power, and notes for serial transfer.

2-1. Sample application 1 where the standby function is used for power failure backup.

Shown below is a sample application where the program does not select between power-ON reset and reset after power is restored.

2-1-1. Sample application circuit – (1)

Fig. 2-1 shows a sample application where the standby function is used for power failure backup.

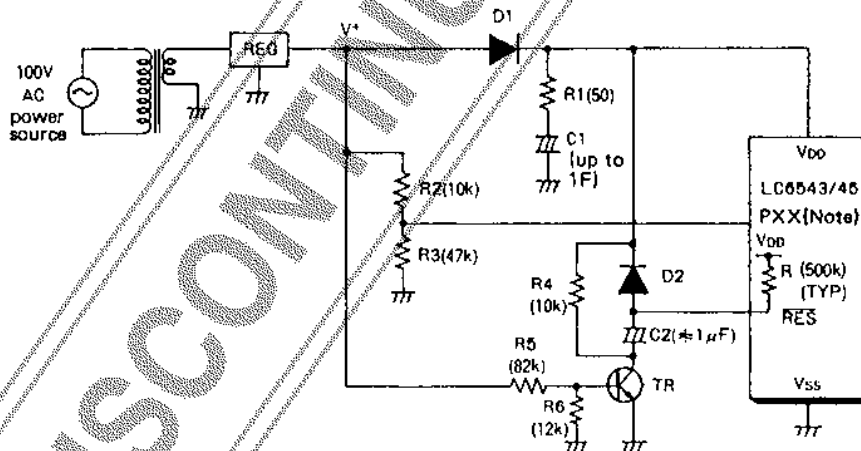

(Note) Normal input ports other than PA₃

Fig. 2-1. Sample application – (1) where the standby function is used for power failure backup

2-1-2. Operating waveform in sample application circuit – (1)

The operating waveform in the sample application circuit in Fig. 2-1 is shown in Fig. 2-2. The mode is roughly divided as follows:

- (a) Power-ON reset
- (b) Instantaneous break of main power source
- (c) Return from power failure backup

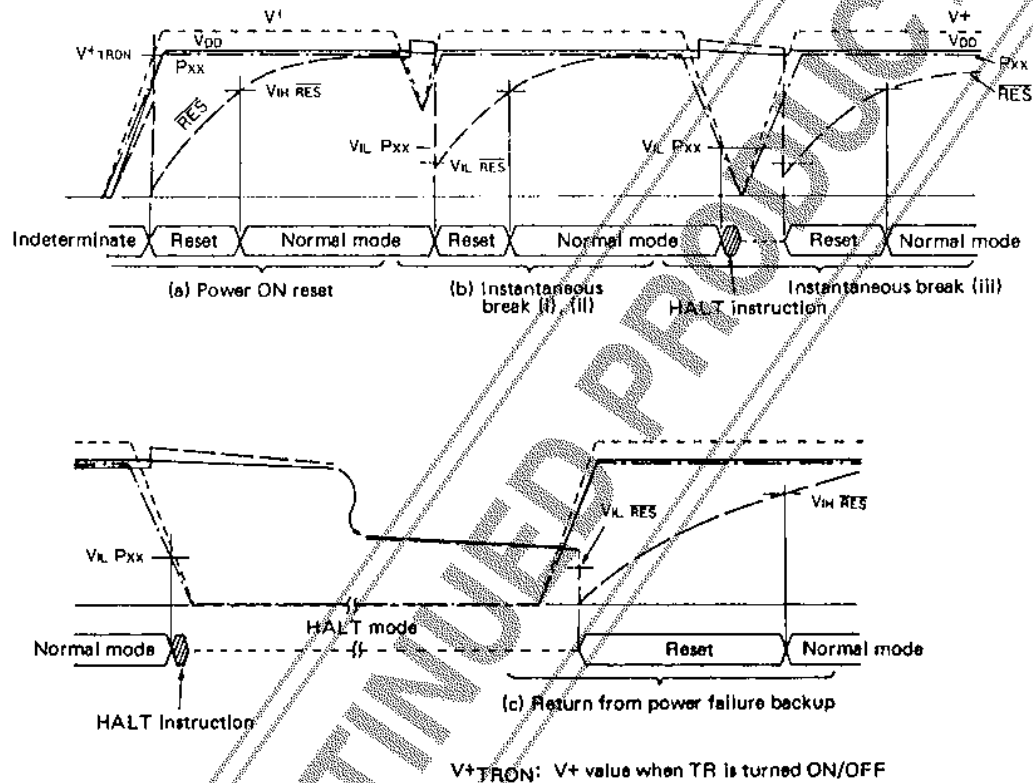

Fig. 2-2 Operating waveform in sample application circuit – (1)

2-1-3. Operation of sample application circuit – (1)

- (a) At the time of power-ON reset
After power rises, a reset occurs automatically and the execution of the program starts at address 000H of the program counter (PC).

– Note –

This sample application circuit provides an indeterminate region where no reset occurs before the operating V_{DD} range is entered.

- (b) At the time of instantaneous break
- (i) When the P_{XX} input voltage does not meet V_{IL} (the P_{XX} input level does not get lower than input threshold level V_{IL}) and the RES input voltage only meets V_{IL}:
A reset occurs in the normal mode, providing the same operation as power-ON reset.
 - (ii) When both of the P_{XX} input voltage and RES input voltage do not meet V_{IL}:
The program continues running in the normal mode.
 - (iii) When both of the P_{XX} input voltage and RES input voltage meet V_{IL}:
When two pollings do not regard the P_{XX} input voltage as "L" level, the HALT mode is not entered and a reset occurs.
When two pollings regard the P_{XX} input voltage as "L" level, the HALT mode is entered and after power is restored a reset occurs, releasing the standby mode.
- (c) At the time of return from power failure backup
After power is restored, a reset occurs, releasing the standby mode.

2-1-4. Notes for design of sample application circuit – (1)

- V⁺ rise time and C2
Make the time constant (C2, R) of the reset circuit 10 times as long as the V⁺ rise time. (R: ON-chip resistor, 500kohms typ.)
Make the V⁺ rise time shorter (up to 20ms).
- R1 and C1
Make the R1 value as small as possible. Make the C1 value as large as possible according to the backup time calculated. (Fix the R1 value so that the C1 charging current does not exceed the power source capacity.)
- R2 and R3
Make the "H"-level input voltage applied to the P_{XX} pin equal to V_{DD}.
- R4
Fix the time constant of C2 and R4 so that C2 can discharge during the period of time from when V⁺ gets lower than V⁺TRON (TR OFF) at the time of instantaneous break until the P_{XX} input voltage gets lower than V_{IL} (because release by reset is not available after the HALT mode is entered by instantaneous break).
- R5 and R6
Make V⁺ (VBE+0.6V is obtained by R5 and R6) when the reset circuit works (Tr ON) more than (operating V_{DD} min + V_F of diode D1). Observing this note, make V⁺ as low as possible to provide a reset early enough after power-ON.
- Backup time
The normal operation continues with a relatively high current dissipation from when power failure is detected by the P_{XX} until the HALT instruction is executed. Fix the C1 value so that the standby supply voltage is held during backup time of set + above-mentioned time.

2-1-5. Notes for software design

- Design the program so that port A0 to A2 cannot be used for standby release and port A3 is brought to "H" level at the standby mode.
- Check a standby request by polling the input port twice.

(Example)

```

BP1      AAA      ;1st polling
RCTL     3        ;Interrupt Inhibit
BP1      AAA      ;2nd polling
HALT     ;Standby
AAA:     :
    
```

2-2. Sample application 2 where the standby function is used for power failure backup

Shown below is a sample application where the program selects between power-ON reset and reset after power is restored.

2-2-1. Sample application circuit – (2) (No instantaneous break in power source)

Fig. 2-3 shows a sample application where the standby function is used for power failure backup.

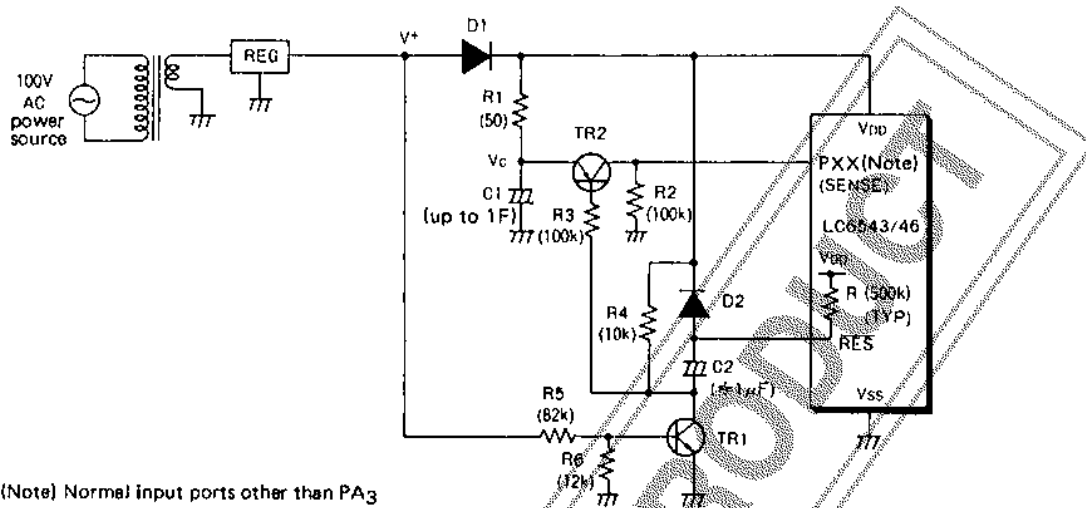

Fig. 2-3. Sample application – (2) where the standby function is used for power failure backup

2-2-2. Operating waveform in sample application circuit – (2)

The operating waveform in the sample application circuit in Fig. 2-3 is shown in Fig. 2-4. The mode is roughly divided as follows:

- (1) Power-ON reset
- (2) Return from power failure backup

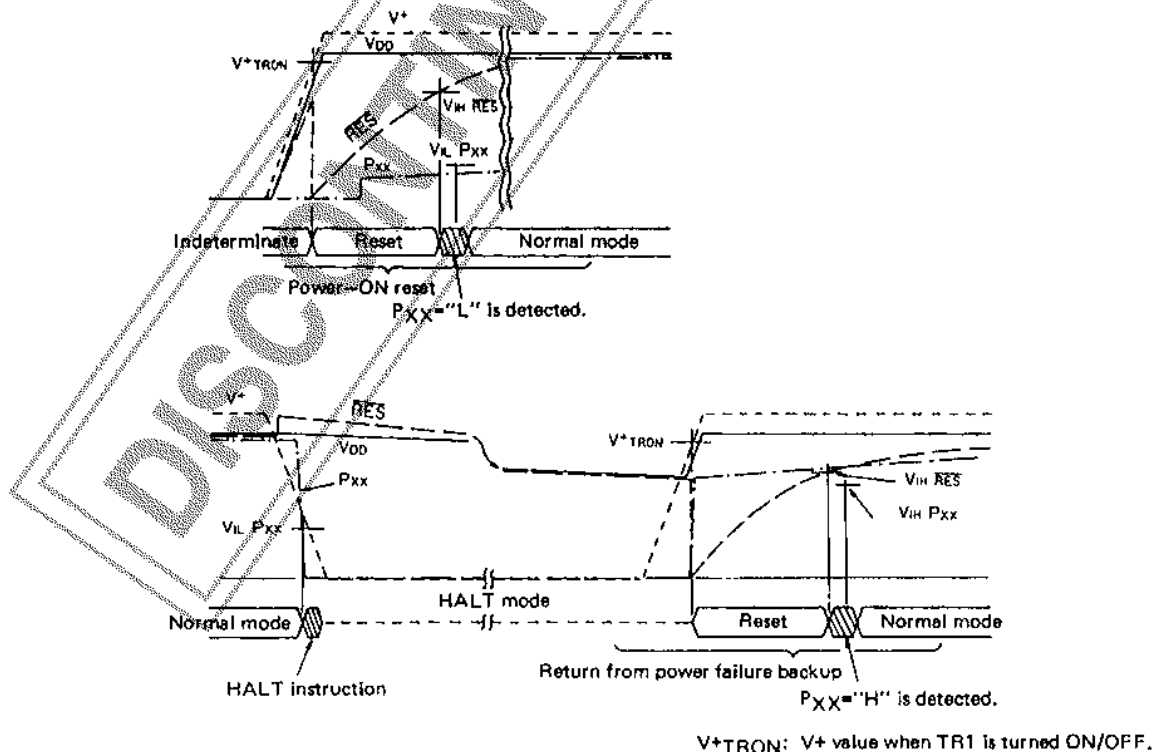

Fig. 2-4. Operating waveform in sample application circuit – (2)

2-2-3. Operation of sample application circuit – (2)

- (a) At the time of power-ON reset
The operation and notes are the same as for sample application circuit – (1), except that after reset release P_{XX}="L" is program-detected to decide program start after initial reset.
 - (b) Standby initiation
When one polling regards the P_{XX} input voltage as "L" level, the HALT mode is entered.
 - (c) At the time of return from power failure backup
After power is restored, a reset occurs, releasing the standby mode. After standby release P_{XX}="H" is program-detected, deciding program start after power is restored.
- Note –
If power is restored after V_{DD} during power failure backup gets lower than V_{IH} on the P_{XX}, P_{XX}="L" may be program-detected, deciding program start after initial reset.

2-2-4. Notes for design of sample application circuit – (2)

- R2 and R3
Fix the R2 value so that R2 > R1 is yielded and fix the R3 value so that I_B of TR2 is limited.
- R4
There is no severe restriction on the R4 value, but fix it so that C2 can discharge quickly.
Other notes are the same as for sample application circuit – (1).

2-2-5. Notes for software design

- Design the program so that port A₀ to A₂ cannot be used for standby release and port A₃ is brought to "H" level.
- Check a standby request by polling the input port once.

(Example)

```

:
BP1      AAA      Polling
HALT
AAA:     :      Standby
    
```

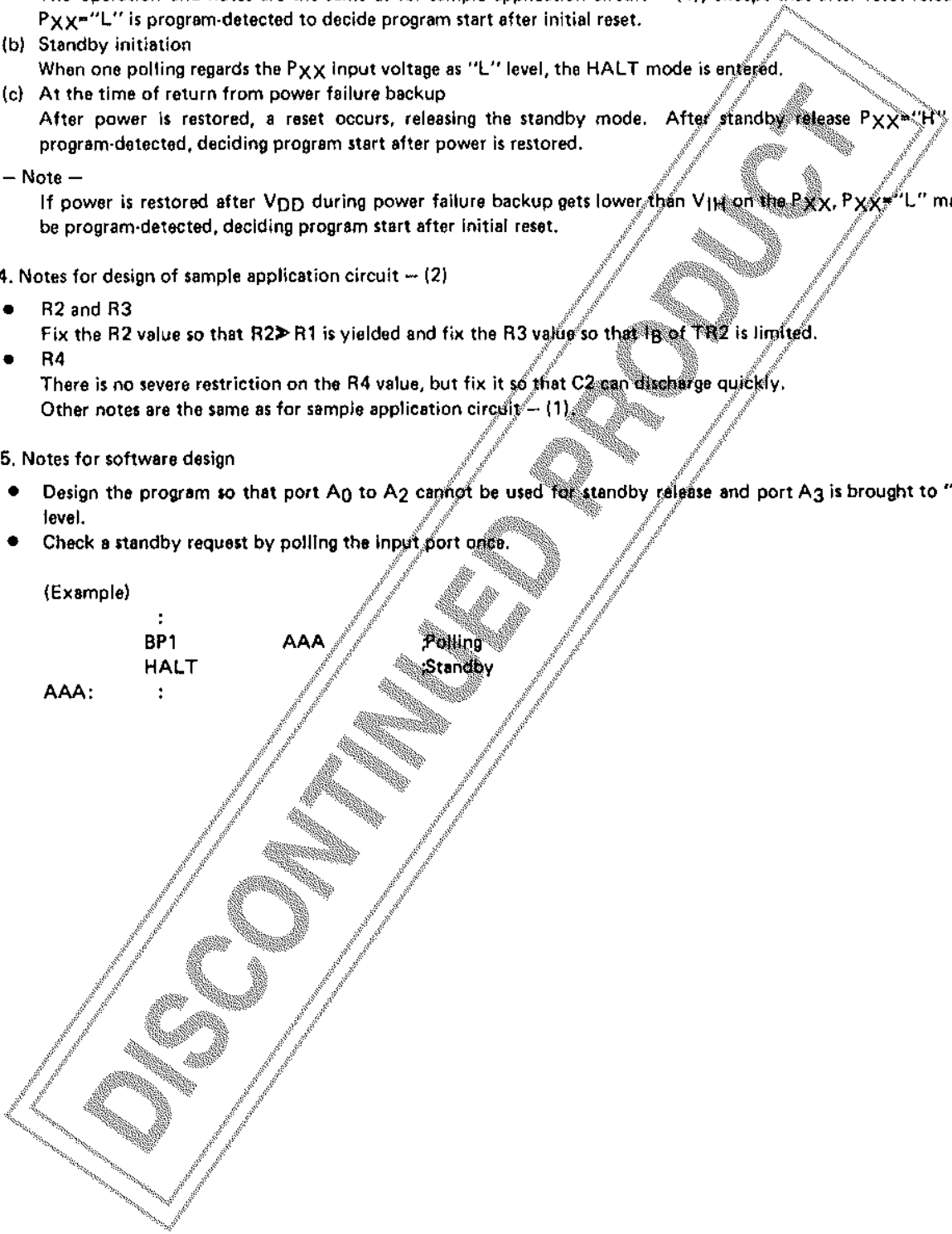

2-3. Sample application 3 where the standby function is used for power failure backup.

2-3-1. Sample application circuit - (3) (There is an instantaneous break in power source.)

Fig. 2-5 shows a sample application where the standby function is used for power failure backup.

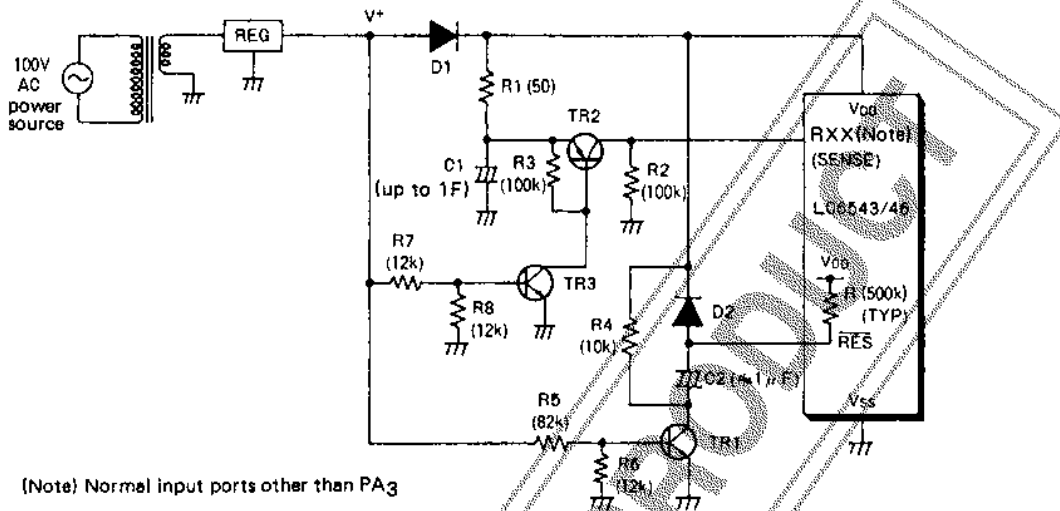

(Note) Normal input ports other than PA3

Fig. 2-5. Sample application - (3) where the standby function is used for power failure backup

2-3-2. Operating waveform in sample application circuit - (3)

The operating waveform in the sample application circuit in Fig. 2-5 is shown in Fig. 2-6. The mode is roughly divided as follows:

- (1) Power-ON reset
- (2) Instantaneous break of main power source
- (3) Return from power failure backup

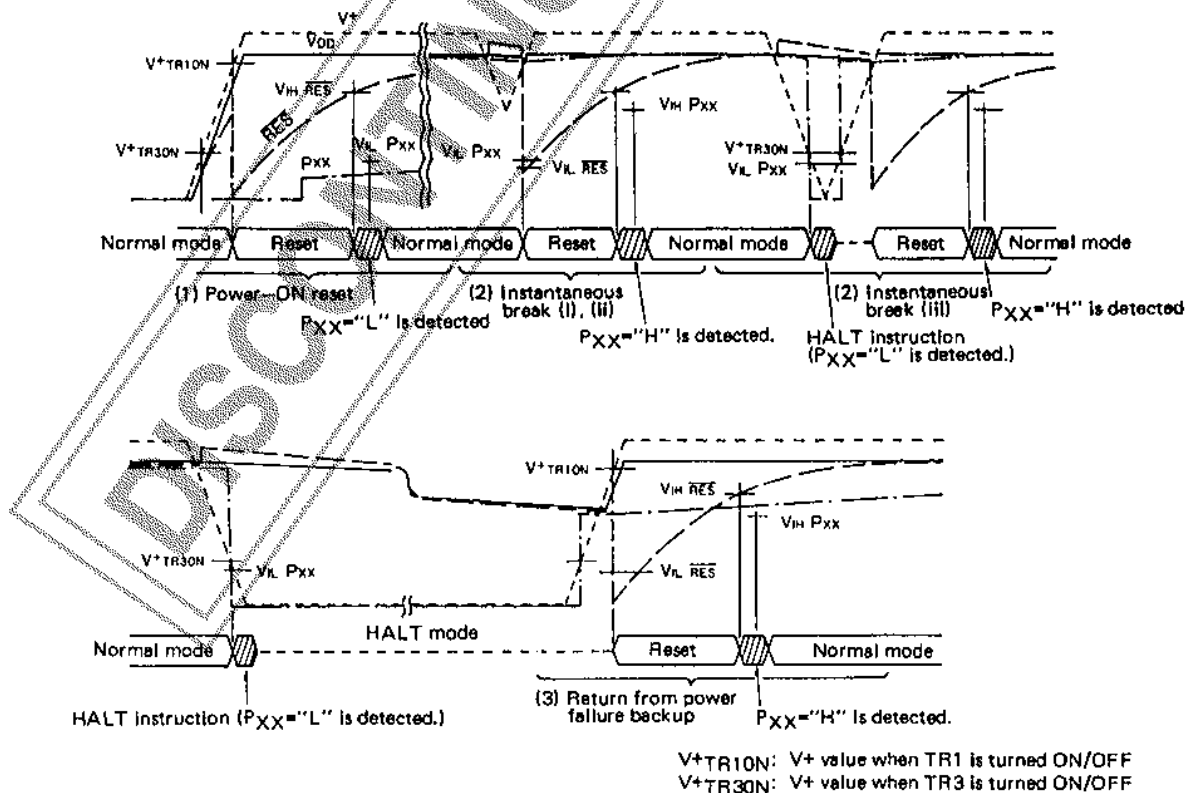

Fig. 2-6. Operating waveform in sample application circuit - (3)

2-3-3. Operation of sample application circuit – (3)

- (a) At the time of power-ON reset
The operation and notes are the same as for sample application circuit – (2)
- (b) At the time of instantaneous break
- (i) When the P_{XX} input voltage does not meet V_{IL} (the P_{XX} input level does not get lower than input threshold level V_{IL}) and the \overline{RES} input voltage only meets V_{IL} :
A reset occurs in the normal mode. After reset release P_{XX}="H" is program-detected, deciding program start after instantaneous break.
 - (ii) When both of the P_{XX} input voltage and \overline{RES} input voltage do not meet V_{IL} :
The program continues running in the normal mode.
 - (iii) When both of the P_{XX} input voltage and \overline{RES} input voltage meet V_{IL} :
When two pollings do not regard the P_{XX} input voltage as "L" level, the HALT mode is not entered and a reset occurs.
When two pollings regard the P_{XX} input voltage as "L" level, the HALT mode is entered and after power is restored a reset occurs, releasing the standby mode. After standby release P_{XX}="H" is program-detected, deciding program start after instantaneous break.
- (c) At the time of return from power failure backup
The operation and notes are the same as for sample application circuit – (2)

2-3-4. Notes for design of sample application circuit – (3)

- R3
Bias resistance of TR2
 - R7 and R8
Fix the R7 and R8 values so that TR3 is turned ON/OFF at approximately 1.5V of V₊.
- Other notes are the same as for sample application circuit – (1)

2-3-5. Notes for software design

Same as for sample application circuit – (1)

2-4. Notes (1) for providing serial transfer

Notes for providing power failure backup and serial transfer

This application assigns top priority to power failure backup. When power failure backup is provided, serial transfer may not be provided normally.

- (1) When the internal clock is used for the serial clock:
Execute the serial transfer start instruction immediately before executing the HALT instruction. If this is done during serial transfer, the power failure backup mode is entered without normal transfer.
- (2) When the external clock is used for the serial clock:
When power failure is detected, it is most prioritized that the HALT mode is entered, providing power failure backup. It is necessary to design an application system where no release signal by serial transfer completion is input to the HALT instruction execution cycle and no release signal is input during backup.

2-5. Notes (2) for providing serial transfer

Notes for providing HALT and serial transfer for program standby without power failure backup

This application assigns top priority to serial transfer. The following notes for system design must be observed.

- (1) When the internal clock is used for the serial clock:
Transfer starts when it is ready on both sides. When transfer is not ready on the other side, the HALT instruction is executed to reduce the current dissipation. When transfer is ready, the HALT release signal (\overline{RES} , PA) causes return from the standby mode, starting serial transfer.
- (2) When the external clock is used for the serial clock:
Synchronization must be provided between microcomputers to prevent the HALT instruction and HALT release signal ($\overline{RSIOEND}$) from overlapping. When transfer is ready, the serial transfer start instruction is executed and the program is placed in the wait state. The other side adjusts time so that no overlap occurs between the HALT instruction and transfer completion and starts serial transfer. On completion of transfer, the HALT mode is released and the program is executed with an instruction immediately following the HALT instruction.

Notes for Program Evaluation

- When evaluating the LC6543/46 with the evaluation chip (LC6594, LC65PG43-A/46-A, LC65PG43/46), the following must be observed.

| Classification | Item | Function | | Notes for evaluation |
|------------------|---------------------------------------|--|--|---|
| | | Mass-production chip | Evaluation chip | |
| Notes for option | 2-pin OSC | PI0 and OSC2 share one pin (PI0/OSC2). Either of them is selected exclusively by user option. When 2-pin OSC is selected, PI0/OSC2 pin provides OSC2 and performs no function of PI0 port. Data input to PI0/OSC2 by mistake is always read as "0". | Evaluation chip has PI0 and OSC2 separately. Pin required for option is selected as required. Even when OSC2 pin is selected by option, PI0 circuit is present and functions as complete port PI0. | Since input/output at PI0 on evaluation chip results in difference between evaluation chip operation and mass-production chip operation, input/output at PI0 is prohibited. |
| | 1-pin OSC | When 1-pin C OSC is selected, OSC circuit is formed by connecting catalog guaranteed C to OSC1 pin. | Since no OSC circuit for 1-pin C OSC is contained, 1-pin C OSC is not available. | 2-pin RC provides OSC and frequency is adjusted as desired. OSC characteristic differs, but there is no restriction on program (ES, CS must be used to evaluate OSC characteristic in detail). |
| | OSC divider | 3 selections (1/1, 1/3, 1/4) by option | 3 selections (1/1, 1/3, 1/4) available by 2 pins of DIV pin, 3OR4 pin. | DIV pin, 3OR4 pin must be set according to option specified for mass-production chip. |
| | Ports C, D output level at reset mode | Ports C, D can be brought to "H" or "L" in a group of 4 bits. | Port C and port D can be brought to "H" and "L" by CHL pin and DHL pin respectively. | CHL pin and DHL pin must be set according to option specified for mass-production chip. |
| | Port output configuration PU/OD | PU or OD can be selected bitwise. | Only OD without PU. | [LC6594-applied evaluation] External resistor (10kohms) on evaluation board must be connected to necessary port. [Piggyback-applied evaluation] Resistor must be connected to necessary port on application board. |
| | PU resistor configuration | PU resistor brought to Hi-Z (Pch Tr to turn OFF) at "L" output mode. | PU resistor, being external resistor, whose impedance remains unchanged at "L" output mode. | For mass-production chip, leakage current only flows in Pch Tr at "L" output mode; for evaluation chip, current continues flowing in PU resistor at "L" output mode. |

LC6543C, 6543H, 6546C, 6546H

| Classification | Item | Function | | Notes for evaluation |
|--------------------------------------|------------------------------------|--|--|--|
| | | Mass-production chip | Evaluation chip | |
| Notes for OSC | OSC constants -1 | [2-pin RC OSC] Catalog-guaranteed constants provide OSC at frequency specified in catalog. | [2-pin RC OSC] Different from mass-production chip in circuit design and characteristic. | [2-pin RC OSC] Frequency must be adjusted to OSC frequency of mass-production chip by adjusting variable resistor. |
| | | [2-pin ceramic resonator OSC] Catalog-guaranteed constants provide OSC at frequency specified in catalog. | [2-pin ceramic resonator OSC] Different from mass-production chip in circuit design and characteristic. Wiring capacitance may provide unstable OSC. | [2-pin ceramic resonator OSC] External constants must be fine-adjusted according to service conditions. |
| | OSC constants -2 | [2-pin ceramic resonator OSC] Feedback resistor is contained. | [2-pin ceramic resonator OSC] No feedback resistor is contained. | [2-pin ceramic resonator OSC] For evaluation chip, feedback resistor of 1Mohm must be connected externally. |
| Notes for electrical characteristics | OSC frequency | OSC frequency characteristic as indicated in catalog. | Different from mass-production chip in circuit design, and characteristic. | ES, CS must be used to evaluate characteristic in detail. The standby current cannot be evaluated in detail. However, the standby current can be confirmed roughly in the manner discussed later. Be sure to confirm the standby current. |
| | Operating current, standby current | Current characteristic as indicated in catalog. | Different from mass-production chip in circuit design, and characteristic. | |
| Notes for operating conditions | Operating voltage | Supply voltage range as indicated in catalog. | Evaluation chip must be also used at $V_{DD}=5V\pm5\%$ at which EPROM, other LSI are used. | |
| | Operating temperature | Temperature range as indicated in catalog. | Evaluation chip must be used at 10°C to 40°C. | |
| | Port A input voltage | Input/output configuration of normal threshold input. Input voltage as indicated in catalog. | Input/output configuration of low threshold input. Different from mass-production chip in input/output configuration. | |
| | Type No. setting | LC6543/46 differ in ROM, RAM capacity. | RAM capacity is set by RAMC pin according to Type No. | SW3-2 on evaluation board is always placed in PA position. SW3-1 is set according to Type No. |

(Confirmation methods for the standby function)

The standby current at the standby mode of the simulation chip can be evaluated not exactly but approximately. Then, do the following steps.

(a) Confirmation of the standby state

Be sure to confirm whether or not the LSI enters the standby mode when the standby conditions are satisfied.

- (i) When the OSC1 and OSC2 oscillation option is selected, confirm on an oscilloscope that the oscillation stops in the standby mode.

When the OSC1 terminal C oscillation is used on the LC6543/46 microcomputer, the OSC1 and OSC2 RC (Capacitor-Resistor) oscillation is used for evaluating functions because the simulation chip has no OSC1 terminal C oscillation option. At this time, also confirm on an oscilloscope that the oscillation stops in the standby mode.

- (ii) Confirmation by the current dissipation

Remove the EPROM when confirming whether or not the LSI enters the standby mode. The I_{DD} of the LSI can determine whether or not the LSI is now in the standby mode.

When the LSI is in the operating mode, more than some $100\mu A$ current is transmitted. When in the standby mode, the current of the I_{DD} is $150\mu A$ or less if the DIV, 3OR4, CHL, DHL and RAMC are all set to "H" (excluding the load current). If the DIV, 3OR4, —, etc. are all set to "L", the current of the I_{DD} is approximately $20\mu A$.

(b) Confirmation by the load current

Your program must be designed so that the current is not transmitted to the input/output ports prior to the execution of the HALT instruction. This can reduce the useless dissipation of the load current at the standby mode and be confirmed on an oscilloscope.

- (i) Design your program so that the current is not transmitted to the output ports prior to the execution of the HALT instruction.
- (ii) Design your program and peripherals so that the input ports and input/output ports are not brought to the floating state at the standby mode.

If brought to the floating state, current flows in the microcomputer input circuit section, causing more current dissipation. Therefore, the backup enable time is shortened extremely in applications where the capacitor backup is used.

Ceramic resonator oscillation constants when the EVA-TB6543/46 is used

When developing your program using the target board EVA-TB6543/46, use the constants shown below because the ceramic resonator oscillation constants depend on the conditions for evaluation and the cable length, etc.

Note) When the evaluation chip is used in the 2-pin ceramic resonator oscillation mode, no feedback resistor is contained unlike the mass-production chip.

Connect a feedback resistor of 1Mohm externally as shown below.

Since constants R, C are also differ from those for the mass-production chip, refer to Table shown below and adjust the capacitor value according to the stray capacitance of the circuit.

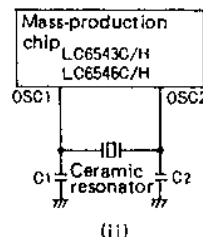
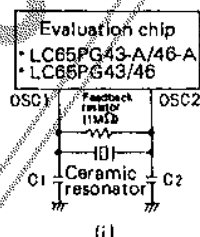

2-pin Ceramic Resonator Oscillation Circuit for Evaluation Chip and Mass-production Chip

Table of Ceramic Resonator Oscillation Constants when the EVA-TB6543/46 is used

| Ceramic resonator | | Mas-production chip C1 = C2 | Evaluation chip (*) | | | |
|-------------------|--------------------|-----------------------------|---|-------|--|-------|
| | | | Including capacitance of standard cable | | Including no capacitance of standard cable | |
| | | | C1 = C2 | R | C1 = C2 | R |
| 4MHz | CSA4.00MG (Murata) | 33pF | 8pF | 0 ohm | 33pF | 0 ohm |
| | KBR4.0M (Kyocera) | 33pF | 10pF | 0 ohm | 33pF | 0 ohm |
| 1MHz | CSB1000K (Murata) | (CSB1000D used) 220pF | 82pF | 0 ohm | 220pF | 0 ohm |
| | KBR1000H (Kyocera) | 100pF | 82pF | 0 ohm | 220pF | 0 ohm |
| 800kHz | CSB800K (Murata) | (CSB800D used) 220pF | 220pF | 0 ohm | 220pF | 0 ohm |
| | KBR800H (Kyocera) | 220pF | 150pF | 0 ohm | 150pF | 0 ohm |
| 400kHz | CSB400P (Murata) | 330pF | 470pF | 0 ohm | 470pF | 0 ohm |
| | KBR400B (Kyocera) | 330pF | 390pF | 0 ohm | 330pF | 0 ohm |
| | KBR400H | | | | | |

- (*) The standard cable is a cable attached to target board EVA-TB6543/46.
 The Table shows two cases where the capacitance of the cable is included and no capacitance of the cable is included.
- Example where the capacitance of the cable is included
 The capacitance of the cable is included when the resonator is connected to the user's application board through the cable from the EVA-TB6543/46.
 - Example where no capacitance of the cable is included
 No capacitance of the cable is included when the resonator is placed near the evaluation chip (on the EVA-TB6543/46).

When using any other cable than the attached cable, adjust the capacitor value according to the stray capacitance.

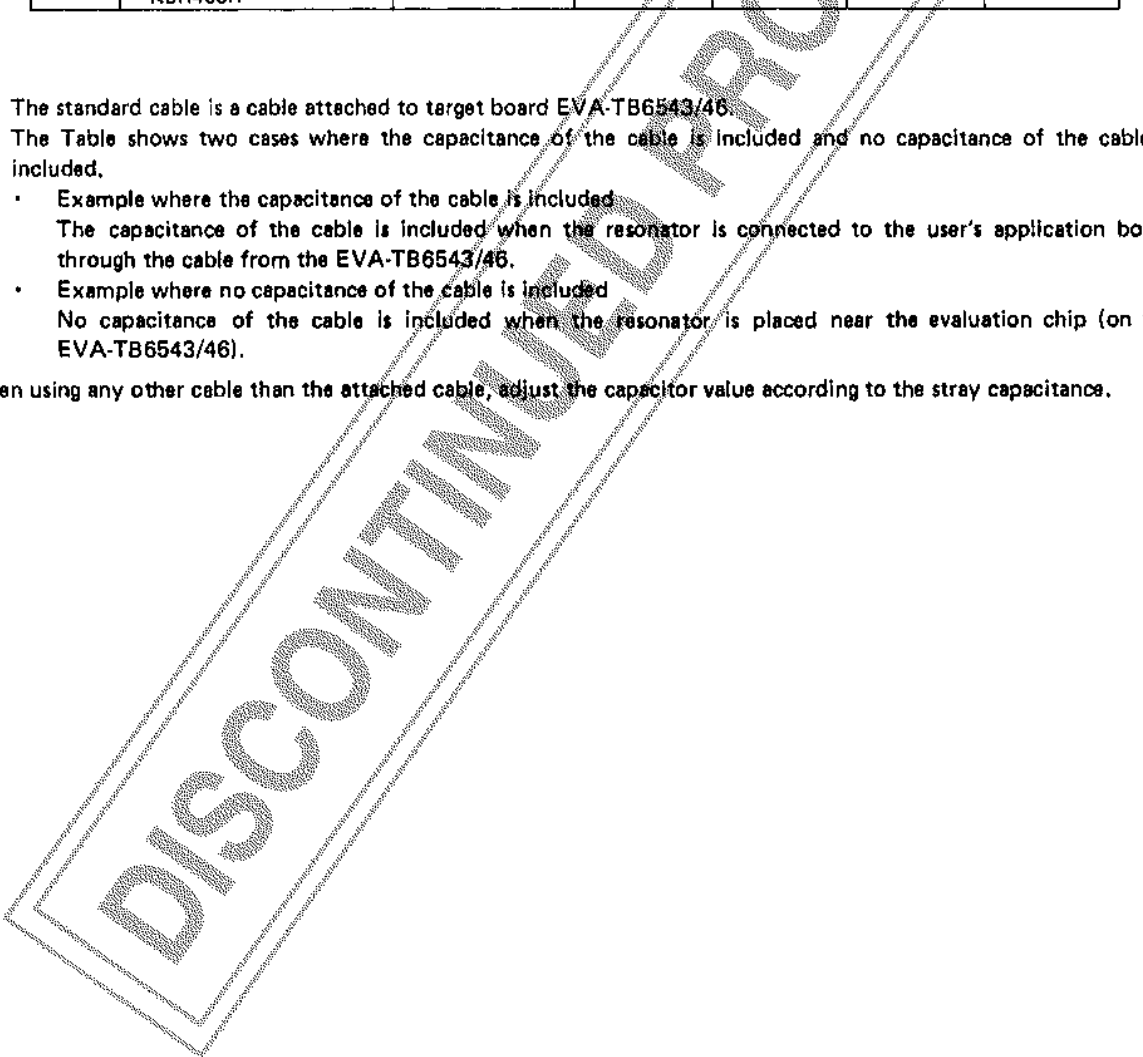

How to use the piggyback chip (LC65PG43/46-A)

(1) Layout of pins and control pads, and External dimensions

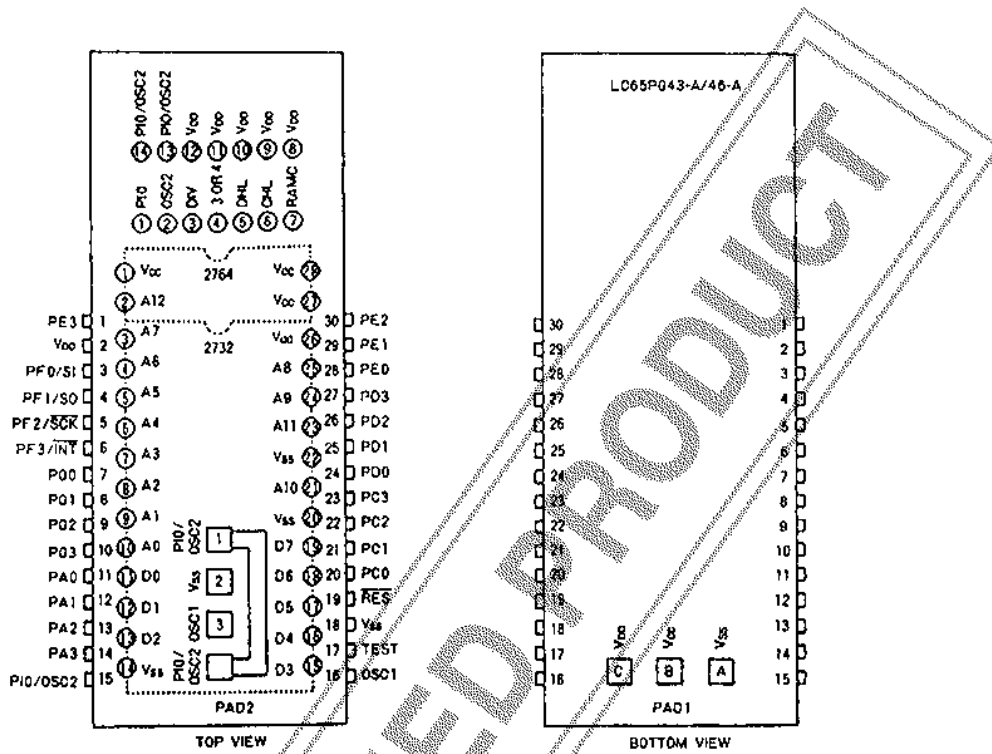

PAD1: Power supply pad
PAD2: Mounting pad for oscillation circuit components

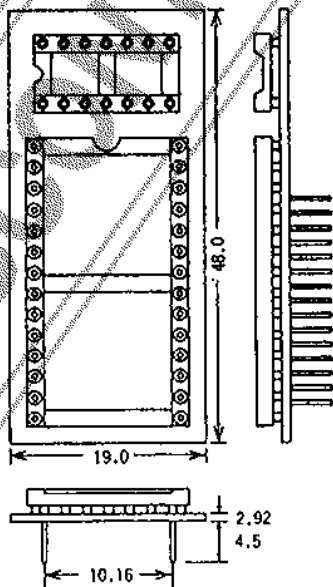

(2) How to mount EPROM

The EPROM to be mounted should contain an already-assembled program data. To write data to the EPROM, use the EPROM writer function on the EVA-800 or EVA-410C board. The mountable EPROM is an Intel 2732, 2764 or their equivalents.

EPROM (2732 or 2764) for program data

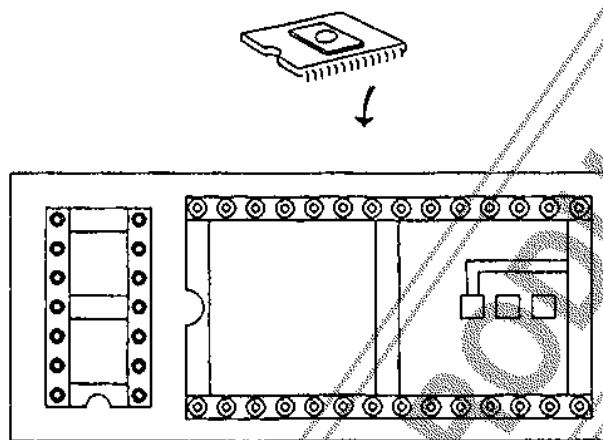

(3) Power supply for EPROM

A typical EPROM dissipates the current of 50mA to 100mA. If the power capacity of an application product board is not sufficient, use an independent power supply circuit to provide the EPROM with the current externally.

- a) At the factory shipment, the EPROM uses the same power supply circuit as the simulation chip does. To supply external current to the EPROM, the EPROM power supply selection jumpers are provided on the reverse side of the simulation chip. At the factory shipment, the circuit connection is arranged so that current can be supplied to the EPROM through the power supply pin (V_{DD} pin) of the simulation chip.

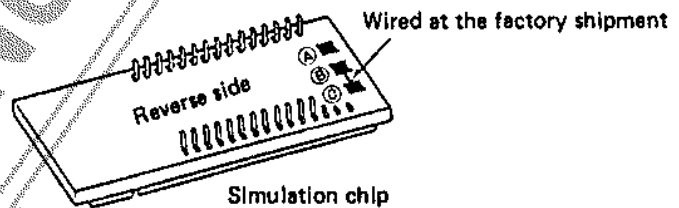

- (A) Connected to the GND (0V) pin.
 (B) Connected to the EPROM power supply pin.
 (C) Connected to the power supply pin of the simulation chip.

[Note that the circuit connection is arranged at the factory shipment so that the current can be supplied to an EPROM through the simulation chip.]

- b) To supply current to an EPROM externally from an independent power source
 Disconnect pattern (B) from pattern (C).
 Connect the power supply pin (+5V) of an external independent power source circuit to pattern (B) and then the other pin to pattern (A)(GND).

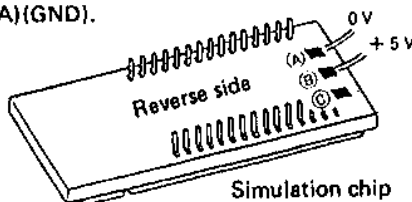

[To supply current to an EPROM from an external power source circuit.]

(Note) A simulation chip is an LSI produced in CMOS process technology. The simulation chip will suffer from a "latch up" which is specific to CMOS LSIs if the voltage below the V_{SS} level is applied to input pins and output pins, or if the voltage above the V_{DD} level is applied such pins. The latch up problem may damage or degrade the device. To prevent it, much care should be taken to the power supply circuit design for the simulation chip and an EPROM. In turning on a simulation chip and an EPROM, the simulation chip should be the first and the EPROM, the second. To turn off them, the order is reversed.

(4) Switches and pad for option selection

a) Switches for CPU-function settings

On the simulation chip are provided the switches for selecting a RAM capacity, a desired CPU and its stack level, output logic level at reset for ports C and D, divider circuit's divide ratio, and PIO/OSC2 pin function. These switches are provided on the surface of the simulation chip board.

The figure below shows the outline of the above switches. The switch settings will be described in the item dealing with option specification methods.

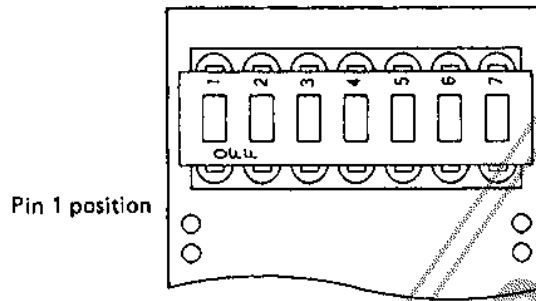

Switch 1 (PIO)Sets the PIO/OSC2 pin to the port IO for input/output.

Switch 2 (OSC2)Sets the PIO/OSC2 pin to the OSC2 pin for oscillation.

Switch 3 (DIV) } Selects the divide ratio for the divider circuit.

Switch 4 (3 or 4) }

Switch 5 (DHL)Select the output logic at the reset for port D.

Switch 6 (CHL)Select the output logic at the reset for port C.

Switch 7 (RAMC)Select a desired CPU from LC6543 and LC6546.

b) Pad 2

The pad 2 is provided on the piggyback LSI to mount oscillation components. Add an external resistor according to a selected oscillation option. The switch settings will be described in the item dealing with option specification methods.

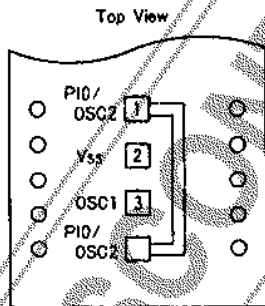

- OSC1 : connected to the OSC1 pin of the LSI.
- PIO/OSC2 : connected to the PIO/OSC2 pin of the LSI.
- VSS : connected to the VSS pin of the LSI.

(5) Option specification methods

a) Option specification method for oscillation circuits

Oscillation circuits can be selected by using the PAD2 and CPU-function setting switches.

(i) Ceramic oscillation circuit

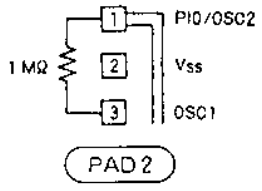

1 MΩ

1 PIO/OSC2

2 V_{SS}

3 OSC1

PAD 2

- Connect the PIO/OSC2 pin with the OSC1 pin through an external resistor of 1MΩ.
- For the oscillation constants of an application board, refer to the catalog.

Fine control may be needed because the ideal RC constant will change due to mounting conditions.

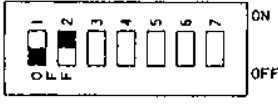

ON

OFF

- Switch 1 . . .Set it to the OFF side.
- Switch 2 . . .Set it to the ON side.
- The PIO/OSC2 pin can be used as OSC2 pin for oscillation.

CPU-function setting switches

(ii) 2-pins RC oscillation circuit

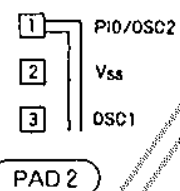

1 PIO/OSC2

2 V_{SS}

3 OSC1

PAD 2

- No external component is required by the PAD2.
- For the oscillation constants of an application board, refer to the catalog.

Fine control may be needed because the oscillation frequency of a mass-production LSI might differ from that of the application board.



ON

OFF

- Switch 1 . . .Set it to the OFF side.
- Switch 2 . . .Set it to the ON side.
- The PIO/OSC2 pin can be used as the OSC2 pin for oscillation.

CPU-function setting switches

(iii) External clock circuit

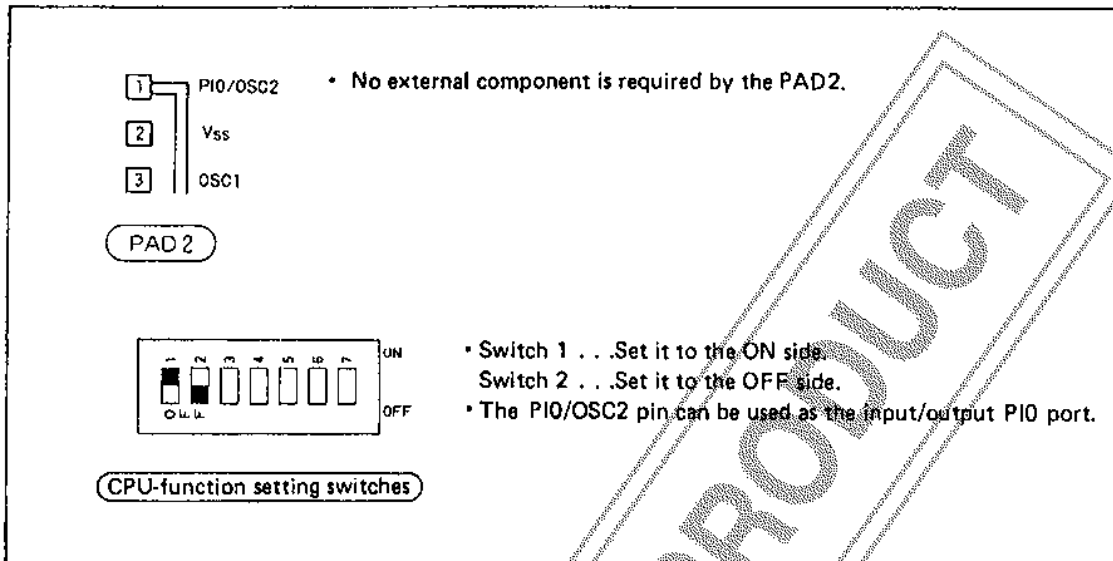

(iv) 1-pin C oscillation circuit

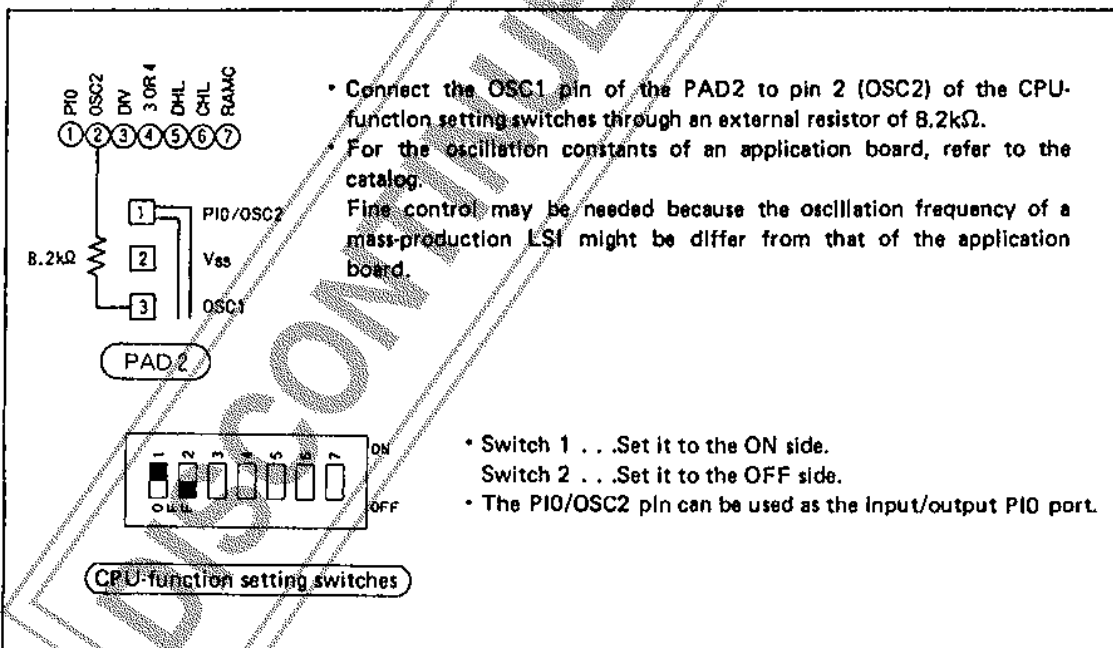

b) Option specification method for dividers

Dividers can be selected by using the CPU-function setting switches.

(i) 1/1 divider circuit

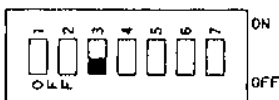

- Switch 3 . . . Set it to the OFF side.
- Switch 4 . . . Set it to either side.

(ii) 1/3 divider circuit

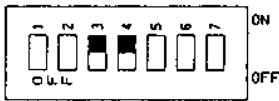

- Switch 3 . . . Set it to the ON side.
- Switch 4 . . . Set it to the ON side.

(iii) 1/4 divider circuit



- Switch 3 . . . Set it to the ON side.
- Switch 4 . . . Set it to the OFF side.

c) Option specification method for the output logics of ports C and D at reset

The output logics of ports C and D at the reset can be specified by using the CPU-function setting switches.

Switch 5 (DHL) Select the output logic of port D at the reset from H and L.

Switch 6 (CHL) Select the output logic of port C at the reset from H and L.

(i) To set the logic level of port D or C at the initial reset to "H" (output OFF in case of open drain output)



- Set switch 5 or switch 6 to the ON side.
- The output logic level of port D or C at the initial reset can be specified independently.

(ii) To set the logic level of port D or C at the initial reset to "L".



- Set switch 5 or switch 6 to the OFF side.
- The output logic level of port D or C at the initial reset can be specified independently.

d) Option specification method for evaluated CPUs

Evaluated microcomputers can be specified by using the CPU-function setting switches.

(i) To develop user application programs for the LC6543 microcomputers.

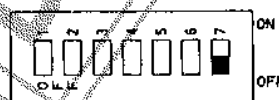

- Set switch 7 to the OFF side.

(ii) To develop user application programs for the LC6546 microcomputers.

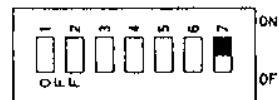

- Set switch 7 to the ON side.

LC6543C, 6543H, 6546C, 6546H SERIES INSTRUCTION SET (BY FUNCTIONS)

| | | | | | |
|----------------|-----------------------------------|-------------------------------------|--|----------|--------------------------|
| Symbol | Description | M(DP) _i | : Memory addressed by DP | (), () | : Contents |
| AC | : Accumulator | PI(DP) _i | : Input/output port addressed by DP _i | ← | : Transfer and direction |
| ACI | : Accumulator bit i | PC | : Program counter | + | : Addition |
| CF | : Carry flag | STACK | : Stack register | - | : Subtraction |
| CTL | : Control register | TM | : Timer | ∧ | : AND |
| DP | : Data pointer | TMF | : Timer (internal) interrupt request flag | ∨ | : OR |
| E | : E register | At, H _n , L _n | : Working register | ⊕ | : Exclusive OR |
| EXTF | : External interrupt request flag | ZF | : Zero flag | | |
| F _n | : Flag bit n | | | | |
| M | : Memory | | | | |

| Instruction group | Mnemonic | Instruction code | | Bytes | Cycles | Function | Description | Status flag affected | Remarks | | | | | | | | | | | | |
|--|---|--|---|---|---|---|---|----------------------|---|--|------------------------------|---|--|------------------------------|---|--|------------------------------|---|-------|-------|--|
| | | D ₇ D ₆ D ₅ D ₄ | D ₃ D ₂ D ₁ D ₀ | | | | | | | | | | | | | | | | | | |
| Accumulator manipulation instructions | CLA | Clear AC | 1 1 0 0 | 0 0 0 0 | 1 1 | AC ← 0 | The AC contents are cleared. | ZF | * 1 | | | | | | | | | | | | |
| | CLC | Clear CF | 1 1 1 0 | 0 0 0 1 | 1 1 | CF ← 0 | The CF contents are cleared. | CF | | | | | | | | | | | | | |
| | STC | Set CF | 1 1 1 1 | 0 0 0 1 | 1 1 | CF ← 1 | The CF is set. | CF | | | | | | | | | | | | | |
| | CMA | Complement AC | 1 1 1 0 | 1 0 1 1 | 1 1 | AC ← \overline{AC} | The AC contents are complemented. | ZF | | | | | | | | | | | | | |
| | INC | Increment AC | 0 0 0 0 | 1 1 1 0 | 1 1 | AC ← (AC) + 1 | The AC contents are incremented +1. | ZF CF | | | | | | | | | | | | | |
| | DEC | Decrement AC | 0 0 0 0 | 1 1 1 1 | 1 1 | AC ← (AC) - 1 | The AC contents are decremented -1. | ZF CF | | | | | | | | | | | | | |
| | RAL | Rotate AC left through CF | 0 0 0 0 | 0 0 0 1 | 1 1 | AC ₀ ← (CF), AC _{n-1} ← (AC _n), CF ← (AC ₇) | The AC contents are shifted left through the CF. | ZF CF | | | | | | | | | | | | | |
| | TAE | Transfer AC to E | 0 0 0 0 | 0 0 1 1 | 1 1 | E ← (AC) | The AC contents are transferred to the E. | | | | | | | | | | | | | | |
| XAE | Exchange AC with E | 0 0 0 0 | 1 1 0 1 | 1 1 | (AC) ↔ (E) | The AC contents and the E contents are exchanged. | | | | | | | | | | | | | | | |
| Memory manipulation instructions | INM | Increment M | 0 0 1 0 | 1 1 1 0 | 1 1 | M(DP) _i ← (M(DP) _i) + 1 | The M(DP) _i contents are incremented +1. | ZF CF | | | | | | | | | | | | | |
| | DEM | Decrement M | 0 0 1 0 | 1 1 1 1 | 1 1 | M(DP) _i ← (M(DP) _i) - 1 | The M(DP) _i contents are decremented -1. | ZF CF | | | | | | | | | | | | | |
| | SMB bit | Set M data bit | 0 0 0 0 | 1 0 B ₇ B ₀ | 1 1 | M(DP) B ₇ B ₀ ← 1 | A single bit of the M(DP) specified with B ₇ B ₀ is set. | | | | | | | | | | | | | | |
| | RMB bit | Reset M data bit | 0 0 1 0 | 1 0 B ₇ B ₀ | 1 1 | M(DP) B ₇ B ₀ ← 0 | A single bit of the M(DP) specified with B ₇ B ₀ is reset. | ZF | | | | | | | | | | | | | |
| Arithmetic operation/comparison instructions | AD | Add M to AC | 0 1 1 0 | 0 0 0 0 | 1 1 | AC ← (AC) + (M(DP) _i) | Binary addition of the AC contents and the M(DP) _i contents is performed and the result is stored in the AC. | ZF CF | | | | | | | | | | | | | |
| | ADC | Add M to AC with CF | 0 0 1 0 | 0 0 0 0 | 1 1 | AC ← (AC) + (M(DP) _i) + (CF) | Binary addition of the AC, CF contents and the M(DP) _i contents is performed and the result is stored in the AC. | ZF CF | | | | | | | | | | | | | |
| | DAA | Decimal adjust AC in addition | 1 1 1 0 | 0 1 0 1 | 1 1 | AC ← (AC) + 6 | 6 is added to the AC contents. | ZF | | | | | | | | | | | | | |
| | DAS | Decimal adjust AC in subtraction | 1 1 1 0 | 1 0 1 0 | 1 1 | AC ← (AC) + 10 | 10 is added to the AC contents. | ZF | | | | | | | | | | | | | |
| | EXL | Exclusive or M to AC | 1 1 1 1 | 0 1 0 1 | 1 1 | AC ← (AC) ∨ (M(DP) _i) | The AC contents and the M(DP) _i contents are exclusive-ORed and the result is stored in the AC. | ZF | | | | | | | | | | | | | |
| | AND | And M to AC | 1 1 1 0 | 0 1 1 1 | 1 1 | AC ← (AC) ∧ (M(DP) _i) | The AC contents and the M(DP) _i contents are ANDed and the result is stored in the AC. | ZF | | | | | | | | | | | | | |
| | OR | Or M to AC | 1 1 1 0 | 0 1 0 1 | 1 1 | AC ← (AC) ∨ (M(DP) _i) | The AC contents and the M(DP) _i contents are ORed and the result is stored in the AC. | ZF | | | | | | | | | | | | | |
| | CM | Compare AC with M | 1 1 1 1 | 1 0 1 1 | 1 1 | (M(DP) _i) + (AC) + 1 | The AC contents and the M(DP) _i contents are compared and the CF and ZF are set/reset. <table border="1"> <tr> <td>Comparison result</td> <td>CF</td> <td>ZF</td> </tr> <tr> <td>(M(DP)_i) > (AC)</td> <td>0</td> <td>0</td> </tr> <tr> <td>(M(DP)_i) = (AC)</td> <td>1</td> <td>1</td> </tr> <tr> <td>(M(DP)_i) < (AC)</td> <td>1</td> <td>0</td> </tr> </table> | Comparison result | CF | ZF | (M(DP) _i) > (AC) | 0 | 0 | (M(DP) _i) = (AC) | 1 | 1 | (M(DP) _i) < (AC) | 1 | 0 | ZF CF | |
| | Comparison result | CF | ZF | | | | | | | | | | | | | | | | | | |
| | (M(DP) _i) > (AC) | 0 | 0 | | | | | | | | | | | | | | | | | | |
| (M(DP) _i) = (AC) | 1 | 1 | | | | | | | | | | | | | | | | | | | |
| (M(DP) _i) < (AC) | 1 | 0 | | | | | | | | | | | | | | | | | | | |
| CI data | Compare AC with immediate data | 0 0 1 0 0 1 0 0 | 1 1 0 0 1 1 2 1 1 0 | 2 2 | ₃ ₂ ₁ ₀ + (AC) + 1 | The AC contents and the immediate data ₃ ₂ ₁ ₀ are compared and the ZF and CF are set/reset. <table border="1"> <tr> <td>Comparison result</td> <td>CF</td> <td>ZF</td> </tr> <tr> <td> ₃ ₂ ₁ ₀ > (AC)</td> <td>0</td> <td>0</td> </tr> <tr> <td> ₃ ₂ ₁ ₀ = (AC)</td> <td>1</td> <td>1</td> </tr> <tr> <td> ₃ ₂ ₁ ₀ < (AC)</td> <td>1</td> <td>0</td> </tr> </table> | Comparison result | CF | ZF | ₃ ₂ ₁ ₀ > (AC) | 0 | 0 | ₃ ₂ ₁ ₀ = (AC) | 1 | 1 | ₃ ₂ ₁ ₀ < (AC) | 1 | 0 | ZF CF | | |
| Comparison result | CF | ZF | | | | | | | | | | | | | | | | | | | |
| ₃ ₂ ₁ ₀ > (AC) | 0 | 0 | | | | | | | | | | | | | | | | | | | |
| ₃ ₂ ₁ ₀ = (AC) | 1 | 1 | | | | | | | | | | | | | | | | | | | |
| ₃ ₂ ₁ ₀ < (AC) | 1 | 0 | | | | | | | | | | | | | | | | | | | |
| CI DP | Compare DP _i with immediate data | 0 0 1 0 0 1 0 1 | 1 1 0 0 1 1 2 1 1 0 | 2 2 | (DP _i) ₁ ∨ ₃ ₂ ₁ ₀ | The DP _i contents and the immediate data ₃ ₂ ₁ ₀ are compared. | ZF | | | | | | | | | | | | | | |
| Load/store instructions | LI data | Load AC with immediate data | 1 1 0 0 | ₃ ₂ ₁ ₀ | 1 1 | AC ← ₃ ₂ ₁ ₀ | The immediate data ₃ ₂ ₁ ₀ is loaded in the AC. | ZF | * 1 | | | | | | | | | | | | |
| | S | Store AC to M | 0 0 0 0 | 0 0 1 0 | 1 1 | M(DP) _i ← (AC) | The AC contents are stored in the M(DP) _i . | | | | | | | | | | | | | | |
| | L | Load AC from M | 0 0 1 0 | 0 0 0 1 | 1 1 | AC ← (M(DP) _i) | The M(DP) _i contents are loaded in the AC. | ZF | | | | | | | | | | | | | |
| | XM data | Exchange AC with M then modify DP _k with immediate data | 1 0 1 0 | 0 M ₇ M ₁ M ₀ | 2 | AC _i ↔ (M(DP) _i) DP _k ← (DP _k) ∨ 0 M ₇ M ₁ M ₀ | The AC contents and the M(DP) _i contents are exchanged and then the DP _k contents are modified with the contents of DP _k ∨ 0M ₇ M ₁ M ₀ . | ZF | The ZF is set/reset according to the result of (DP _k) ∨ 0M ₇ M ₁ M ₀ . | | | | | | | | | | | | |
| | X | Exchange AC with M | 1 0 1 0 | 0 0 0 0 | 1 2 | (AC) _i ↔ (M(DP) _i) | The AC contents and the M(DP) _i contents are exchanged. | ZF | The ZF is set/reset according to the result of (DP _k) ∨ 0M ₇ M ₁ M ₀ . | | | | | | | | | | | | |
| | XI | Exchange AC with M then increment DP _k | 1 1 1 1 | 1 1 1 0 | 1 2 | (AC) _i ↔ (M(DP) _i) DP _k ← (DP _k) + 1 | The AC contents and the M(DP) _i contents are exchanged and then the DP _k contents are incremented +1. | ZF | The ZF is set/reset according to the result of (DP _k) + 1. | | | | | | | | | | | | |
| | XD | Exchange AC with M then decrement DP _k | 1 1 1 1 | 1 1 1 1 | 1 2 | (AC) _i ↔ (M(DP) _i) DP _k ← (DP _k) - 1 | The AC contents and the M(DP) _i contents are exchanged and then the DP _k contents are decremented -1. | ZF | The ZF is set/reset according to the result of (DP _k) - 1. | | | | | | | | | | | | |
| RTBI | Read table data from program ROM | 0 1 1 0 | 0 0 1 1 | 1 2 | AC ← ROM (PC) F AC _i | The contents of ROM addressed by the PC whose low-order 8 bits are replaced with the E and AC contents are loaded in the AC and E. | | | | | | | | | | | | | | | |

LC6543C, 6543H, 6546C, 6546H

| Instruction group | Mnemonic | Instruction code | | Bytes | Cycles | Function | Description | Status flag affected | Remarks | |
|--|--------------------------------|---|---|---|--------|--|--|---|--|---|
| | | D ₇ D ₆ D ₅ D ₄ | D ₃ D ₂ D ₁ D ₀ | | | | | | | |
| Data pointer manipulation instructions | LZ data | 1 0 0 0 | 1 3 1 2 1 1 0 | 1 | 1 | DP _H ← 0 DP _L ← 1 3 1 2 1 1 0 | The DP _H and DP _L are loaded with 0 and the immediate data 1 3 1 2 1 1 0 respectively. | | | |
| | LHI data | 0 1 0 0 | 1 3 1 2 1 1 0 | 1 | 1 | DP _H ← 1 3 1 2 1 1 0 | The DP _H is loaded with the immediate data 1 3 1 2 1 1 0. | | | |
| | IND | 1 1 1 0 | 1 1 1 1 0 | 1 | 1 | DP _L ← (DP _L) + 1 | The DP _L contents are incremented +1. | ZF | | |
| | DED | 1 1 1 0 | 1 1 1 1 1 | 1 | 1 | DP _L ← (DP _L) - 1 | The DP _L contents are decremented -1. | ZF | | |
| | TAL | 1 1 1 1 | 0 1 1 1 1 | 1 | 1 | DP _L ← (AC) | The AC contents are transferred to the DP _L . | | | |
| | TIA | 1 1 1 0 | 1 0 0 1 1 | 1 | 1 | AC ← (DP _L) | The DP _L contents are transferred to the AC. | ZF | | |
| Working register manipulation instructions | XAH | 0 0 1 0 | 0 0 1 1 1 | 1 | 1 | (AC) ↔ (DP _H) | The AC contents and the DP _H contents are exchanged. | | | |
| | XA0 | 1 1 1 0 | 0 0 0 0 0 | 1 | 1 | (AC) ↔ (A0) | The AC contents and the contents of working register A _n are exchanged. A _n is assigned one of A ₀ , A ₁ , A ₂ , A ₃ according to 1 1 1 0. | | | |
| | XA1 | | | | | (AC) ↔ (A1) | | | | |
| | XA2 | | | | | (AC) ↔ (A2) | | | | |
| | XA3 | | | | | (AC) ↔ (A3) | | | | |
| | XHa | 1 1 1 1 | 1 0 0 0 0 | 1 | 1 | (DP _H) ↔ (H0) | The DP _H contents and the contents of working register H _n are exchanged. H _n is assigned either of H0 or H1 according to a. | | | |
| | XH1 | | | | | (DP _H) ↔ (H1) | | | | |
| | XLa | 1 1 1 1 | 0 0 0 0 0 | 1 | 1 | (DP _L) ↔ (L0) | The DP _L contents and the contents of working register L _n are exchanged. L _n is assigned either of L0 or L1 according to a. | | | |
| | XL1 | | | | | (DP _L) ↔ (L1) | | | | |
| | Flag manipulation instructions | SFB flag | 0 1 0 1 | B ₃ B ₂ B ₁ B ₀ | 1 | 1 | F _n ← 1 | The flag specified with B ₃ B ₂ B ₁ B ₀ is set. | | |
| | | RFB flag | 0 0 0 1 | B ₃ B ₂ B ₁ B ₀ | 1 | 1 | F _n ← 0 | The flag specified with B ₃ B ₂ B ₁ B ₀ is reset. | ZF | The flag is divided into 4 groups of F ₀ to F ₃ , F ₄ to F ₇ , F ₈ to F ₁₁ , F ₁₂ to F ₁₅ . The ZF is set/reset according to the 4 bits including a single bit specified with the immediate data B ₃ B ₂ B ₁ B ₀ . |
| | Jump/subroutine instructions | JMP addr | 0 1 1 0 | 1 P ₆ P ₅ P ₄ P ₇ P ₆ P ₅ P ₄ | 2 | 2 | PC ← P ₇ P ₆ P ₅ P ₄ P ₃ P ₂ P ₁ P ₀ | A jump to the address specified with immediate data P ₇ P ₆ P ₅ P ₄ P ₃ P ₂ P ₁ P ₀ occurs. | | |
| JPEA | | 1 1 1 1 | 1 0 1 0 | 1 | 1 | PC ← (E AC) | A jump to the address specified with the contents of the PC whose low-order 8 bits are replaced by the E and AC contents occurs. | | | |
| CZP addr | | 1 0 1 1 | P ₃ P ₂ P ₁ P ₀ | 1 | 1 | STACK ← (PC) + 1 PC ← E PC ₅₋₇ ← P ₃ P ₂ P ₁ P ₀ | A subroutine in page 0 of bank 0 is called. | | | |
| CAL addr | | 1 0 1 0 | P ₆ P ₅ P ₄ P ₇ P ₆ P ₅ P ₄ | 2 | 2 | STACK ← (PC) + 2 PC ← (DP ₀) P ₆ P ₅ P ₄ | A subroutine in bank 0 is called. | | | |
| RT | | 0 1 1 0 | 0 0 1 0 | 1 | 1 | PC ← (STACK) | A return from a subroutine occurs. | | | |
| RTI | | 0 0 1 0 | 0 0 1 0 | 1 | 1 | PC ← (STACK) CF ZF ← CSF ZSF | A return from an interrupt service routine occurs. | ZF CF | | |
| BANK | | 1 1 1 1 | 1 0 1 1 | 1 | 1 | | The bank is changed. A pseudo I/O port is specified. | | Eligible only when used immediately before an I/O instruction or branch instruction. | |
| Branch instructions | BAI addr | 0 1 1 1 | 0 0 1 1 1 0 P ₇ P ₆ P ₅ P ₄ | 2 | 2 | PC ₇₋₀ → P ₇ P ₆ P ₅ P ₄ P ₃ P ₂ P ₁ P ₀ if (AC) = 1 | If a single bit of the AC specified with the immediate data 1 1 1 0 is 1, a branch to the address specified with the immediate data P ₇ P ₆ P ₅ P ₄ P ₃ P ₂ P ₁ P ₀ within the same page occurs. | | Mnemonic is BAI0 to BAI3 according to the value of 1. | |
| | BAI addr | 0 0 1 1 | 0 0 1 1 1 0 P ₇ P ₆ P ₅ P ₄ | 2 | 2 | PC ₇₋₀ → P ₇ P ₆ P ₅ P ₄ P ₃ P ₂ P ₁ P ₀ if (AC) = 0 | If a single bit of the AC specified with the immediate data 1 1 1 0 is 0, a branch to the address specified with the immediate data P ₇ P ₆ P ₅ P ₄ P ₃ P ₂ P ₁ P ₀ within the same page occurs. | | Mnemonic is BAI0 to BAI3 according to the value of 1. | |
| | BMI addr | 0 1 1 1 | 0 1 1 1 1 0 P ₇ P ₆ P ₅ P ₄ | 2 | 2 | PC ₇₋₀ → P ₇ P ₆ P ₅ P ₄ P ₃ P ₂ P ₁ P ₀ if (MIDP) = 1 | If a single bit of the MIDP specified with the immediate data 1 1 1 0 is 1, a branch to the address specified with the immediate data P ₇ P ₆ P ₅ P ₄ P ₃ P ₂ P ₁ P ₀ within the same page occurs. | | Mnemonic is BAI0 to BAI3 according to the value of 1. | |
| | BMI addr | 0 0 1 1 | 0 1 1 1 1 0 P ₇ P ₆ P ₅ P ₄ | 2 | 2 | PC ₇₋₀ → P ₇ P ₆ P ₅ P ₄ P ₃ P ₂ P ₁ P ₀ if (MIDP) = 0 | If a single bit of the MIDP specified with the immediate data 1 1 1 0 is 0, a branch to the address specified with the immediate data P ₇ P ₆ P ₅ P ₄ P ₃ P ₂ P ₁ P ₀ within the same page occurs. | | Mnemonic is BAI0 to BAI3 according to the value of 1. | |
| | BPI addr | 0 1 1 1 | 1 0 1 1 1 0 P ₇ P ₆ P ₅ P ₄ | 2 | 2 | PC ₇₋₀ → P ₇ P ₆ P ₅ P ₄ P ₃ P ₂ P ₁ P ₀ if (PIDP ₁) = 1 | If a single bit of port PIDP ₁ specified with the immediate data 1 1 1 0 is 1, a branch to the address specified with the immediate data P ₇ P ₆ P ₅ P ₄ P ₃ P ₂ P ₁ P ₀ within the same page occurs. | | Mnemonic is BPI0 to BPI3 according to the value of 1. | |
| | BPI addr | 0 0 1 1 | 1 0 1 1 1 0 P ₇ P ₆ P ₅ P ₄ | 2 | 2 | PC ₇₋₀ → P ₇ P ₆ P ₅ P ₄ P ₃ P ₂ P ₁ P ₀ if (PIDP ₁) = 0 | If a single bit of port PIDP ₁ specified with the immediate data 1 1 1 0 is 0, a branch to the address specified with the immediate data P ₇ P ₆ P ₅ P ₄ P ₃ P ₂ P ₁ P ₀ within the same page occurs. | | Mnemonic is BPI0 to BPI3 according to the value of 1. | |
| | BTM addr | 0 1 1 1 | 1 1 0 0 0 P ₇ P ₆ P ₅ P ₄ | 2 | 2 | PC ₇₋₀ → P ₇ P ₆ P ₅ P ₄ P ₃ P ₂ P ₁ P ₀ if (TMF) = 1 then TMF ← 0 | If the TMF is 1, a branch to the address specified with the immediate data P ₇ P ₆ P ₅ P ₄ P ₃ P ₂ P ₁ P ₀ within the same page occurs. The TMF is reset. | TMF | | |

LC6543C, 6543H, 6546C, 6546H

| Instruction group | Mnemonic | Instruction code | | Bytes | Cycles | Function | Description | Status flag affected | Remarks | |
|---------------------------|-----------------------|---|--|--|--------|----------|--|--|---------|--|
| | | D ₇ D ₆ D ₅ D ₄ | D ₃ D ₂ D ₁ D ₀ | | | | | | | |
| Branch instructions | BNTM addr | Branch on no timer | 0 0 1 1 P ₇ P ₆ P ₅ P ₄ | 1 1 0 0 P ₃ P ₂ P ₁ P ₀ | 2 | 2 | PC _{7:0} ← P ₇ P ₆ P ₅ P ₄ P ₃ P ₂ P ₁ P ₀ if TMF = 0 then TMF ← 0 | If the TMF is 0, a branch to the address specified with the immediate data P ₇ P ₆ P ₅ P ₄ P ₃ P ₂ P ₁ P ₀ within the same page occurs. The TMF is reset. | TMF | |
| | BI addr | Branch on interrupt | 0 1 1 1 P ₇ P ₆ P ₅ P ₄ | 1 1 0 1 P ₃ P ₂ P ₁ P ₀ | 2 | 2 | PC _{7:0} ← P ₇ P ₆ P ₅ P ₄ P ₃ P ₂ P ₁ P ₀ if EXTF = 1 then EXTF ← 0 | If the EXTF is 1, a branch to the address specified with the immediate data P ₇ P ₆ P ₅ P ₄ P ₃ P ₂ P ₁ P ₀ within the same page occurs. The EXTF is reset. | EXTF | |
| | BNI addr | Branch on no interrupt | 0 0 1 1 P ₇ P ₆ P ₅ P ₄ | 1 1 0 1 P ₃ P ₂ P ₁ P ₀ | 2 | 2 | PC _{7:0} ← P ₇ P ₆ P ₅ P ₄ P ₃ P ₂ P ₁ P ₀ if EXTF = 0 then EXTF ← 0 | If the EXTF is 0, a branch to the address specified with the immediate data P ₇ P ₆ P ₅ P ₄ P ₃ P ₂ P ₁ P ₀ within the same page occurs. The EXTF is reset. | EXTF | |
| | BC addr | Branch on CF | 0 1 1 1 P ₇ P ₆ P ₅ P ₄ | 1 1 1 1 P ₃ P ₂ P ₁ P ₀ | 2 | 2 | PC _{7:0} ← P ₇ P ₆ P ₅ P ₄ P ₃ P ₂ P ₁ P ₀ if CF = 1 | If the CF is 1, a branch to the address specified with the immediate data P ₇ P ₆ P ₅ P ₄ P ₃ P ₂ P ₁ P ₀ within the same page occurs. | | |
| | BNC addr | Branch on no CF | 0 0 1 1 P ₇ P ₆ P ₅ P ₄ | 1 1 1 1 P ₃ P ₂ P ₁ P ₀ | 2 | 2 | PC _{7:0} ← P ₇ P ₆ P ₅ P ₄ P ₃ P ₂ P ₁ P ₀ if CF = 0 | If the CF is 0, a branch to the address specified with the immediate data P ₇ P ₆ P ₅ P ₄ P ₃ P ₂ P ₁ P ₀ within the same page occurs. | | |
| | BZ addr | Branch on ZF | 0 1 1 1 P ₇ P ₆ P ₅ P ₄ | 1 1 1 0 P ₃ P ₂ P ₁ P ₀ | 2 | 2 | PC _{7:0} ← P ₇ P ₆ P ₅ P ₄ P ₃ P ₂ P ₁ P ₀ if ZF = 1 | If the ZF is 1, a branch to the address specified with the immediate data P ₇ P ₆ P ₅ P ₄ P ₃ P ₂ P ₁ P ₀ within the same page occurs. | | |
| | BNZ addr | Branch on no ZF | 0 0 1 1 P ₇ P ₆ P ₅ P ₄ | 1 1 1 0 P ₃ P ₂ P ₁ P ₀ | 2 | 2 | PC _{7:0} ← P ₇ P ₆ P ₅ P ₄ P ₃ P ₂ P ₁ P ₀ if ZF = 0 | If the ZF is 0, a branch to the address specified with the immediate data P ₇ P ₆ P ₅ P ₄ P ₃ P ₂ P ₁ P ₀ within the same page occurs. | | |
| | BF _n addr | Branch on flag bit | 1 1 0 1 P ₇ P ₆ P ₅ P ₄ | n ₃ n ₂ n ₁ n ₀ P ₃ P ₂ P ₁ P ₀ | 2 | 2 | PC _{7:0} ← P ₇ P ₆ P ₅ P ₄ P ₃ P ₂ P ₁ P ₀ if f _n = 1 | If the flag bit of the 16 flags specified with the immediate data n ₃ n ₂ n ₁ n ₀ is 1, a branch to the address specified with the immediate data P ₇ P ₆ P ₅ P ₄ P ₃ P ₂ P ₁ P ₀ within the same page occurs. | | Mnemonic is BFD to BFD15 according to the value of n. |
| | BNF _n addr | Branch on no flag bit | 1 0 0 1 P ₇ P ₆ P ₅ P ₄ | n ₃ n ₂ n ₁ n ₀ P ₃ P ₂ P ₁ P ₀ | 2 | 2 | PC _{7:0} ← P ₇ P ₆ P ₅ P ₄ P ₃ P ₂ P ₁ P ₀ if f _n = 0 | If the flag bit of the 16 flags specified with the immediate data n ₃ n ₂ n ₁ n ₀ is 0, a branch to the address specified with the immediate data P ₇ P ₆ P ₅ P ₄ P ₃ P ₂ P ₁ P ₀ within the same page occurs. | | Mnemonic is BNF0 to BNF15 according to the value of n. |
| Input/Output instructions | IP | Input port to AC | 0 0 0 0 | 1 1 0 0 | 1 | 1 | AC ← (P ₃ DP ₁) | P ₃ P ₂ P ₁ P ₀ contents are loaded in the AC. | ZF | |
| | OP | Output AC to port | 0 1 1 0 | 0 0 0 0 | 1 | 1 | P ₃ DP ₁ ← (AC) | The AC contents are outputted to port P ₃ DP ₁ . | | |
| | SPB bit | Set port bit | 0 0 0 0 | 0 1 B ₁ B ₀ | 1 | 2 | P ₃ DP ₁ (B ₁ B ₀) ← 1 | A single bit in port P ₃ DP ₁ specified with the immediate data B ₁ B ₀ is set. | | When this instruction is executed, the I contents are destroyed. |
| | RPB bit | Reset port bit | 0 0 1 0 | 0 1 B ₁ B ₀ | 1 | 2 | P ₃ DP ₁ (B ₁ B ₀) ← 0 | A single bit in port P ₃ DP ₁ specified with the immediate data B ₁ B ₀ is reset. | ZF | When this instruction is executed, the I contents are destroyed. |
| Other instructions | SCTL bit | Set control register bit(S) | 0 0 1 0 1 0 0 0 | 1 1 0 0 B ₃ B ₂ B ₁ B ₀ | 2 | 2 | CTL ← (CTL) V B ₃ B ₂ B ₁ B ₀ | The bits of the control register specified with the immediate data B ₃ B ₂ B ₁ B ₀ are set. | | |
| | RCTL bit | Reset control register bit(S) | 0 0 1 0 1 0 0 0 | 1 1 0 0 B ₃ B ₂ B ₁ B ₀ | 2 | 2 | CTL ← (CTL) Λ B ₃ B ₂ B ₁ B ₀ | The bits of the control register specified with the immediate data B ₃ B ₂ B ₁ B ₀ are reset. | ZF | |
| | WTM | Write timer | 1 1 1 1 | 1 0 0 1 | 1 | 1 | TM ← (E), (AC) TMF ← 0 | The E and AC contents are loaded in the timer. The TMF is reset. | TMF | |
| | HALT | Halt | 1 1 1 1 | 0 1 1 0 | 1 | 1 | Halt | All operations stop. | | Only when all pins of port PA are set as I, stop |
| | NOP | No operation | 0 0 0 0 | 0 0 0 0 | 1 | 1 | No operation | No operation is performed, but 1 machine cycle is consumed. | | |

*1 If the CLA instruction is used continuously in such a manner as CLA, CLA, -----, the first CLA instruction only is effective and the following CLA instructions are changed to the NOP instructions. This is also true of the LI instruction.

The application circuit diagrams and circuit constants herein are included as an example and provide no guarantee for designing equipment to be mass-produced. The information herein is believed to be accurate and reliable. However, no responsibility is assumed by SANYO for its use, nor for any infringements of patents or other rights of third parties which may result from its use.