

Serial sound control IC

BH3854AS / BH3854AFS

The BH3854AS and BH3854AFS are signal processing ICs designed for volume and tone control in CD radio cassettes and other audio products. Their three-line serial control enables them to control volume and tone on the basis of signals from a microcomputer, etc.

●Applications

CD radio cassettes, mini component stereo systems, car stereos

●Features

- 1) They facilitate direct serial control from a microcomputer of volume (main volume) and tone (bass, treble). DC control is also possible.
- 2) Volume is produced by a low-distortion, low-noise VCA. Designed to minimize step noise.
- 3) Input amp can be used for gain adjustment, and matrix surround yields powerful sound.
- 4) Stable standard voltage supply and built-in I / O buffer mean that few attachments are needed. SSOP32 package designed to save space.
- 5) Open collector has four outputs, which makes logic control possible.
- 6) Excellent for volume and tone control devices in CD radio cassettes, micro components, car stereos, televisions, etc.
- 7) Digital GND pin and analog GND pin are separated with an impedance of more than 1MΩ.

●Absolute maximum ratings (Ta = 25°C)

Parameter	Symbol	Limits	Unit
Power supply voltage	V _{CC}	8	V
Power dissipation	Pd	BH3854AS	1250*1
		BH3854AFS	1000*2
Operating temperature	Topr	-40~+85	°C
Storage temperature	Tstg	BH3854AS	-55~+125
		BH3854AFS	-55~+150

*1 Reduced by 12.5mW for each increase in Ta of 1°C over 25°C.

*2 Reduced by 8.0mW for each increase in Ta of 1°C over 25°C.

●Recommended operating conditions (Ta = 25°C)

Parameter	Symbol	Min.	Typ.	Max.	Unit
Power supply voltage	V _{CC}	5.4	8.0	9.5	V

● Block diagram

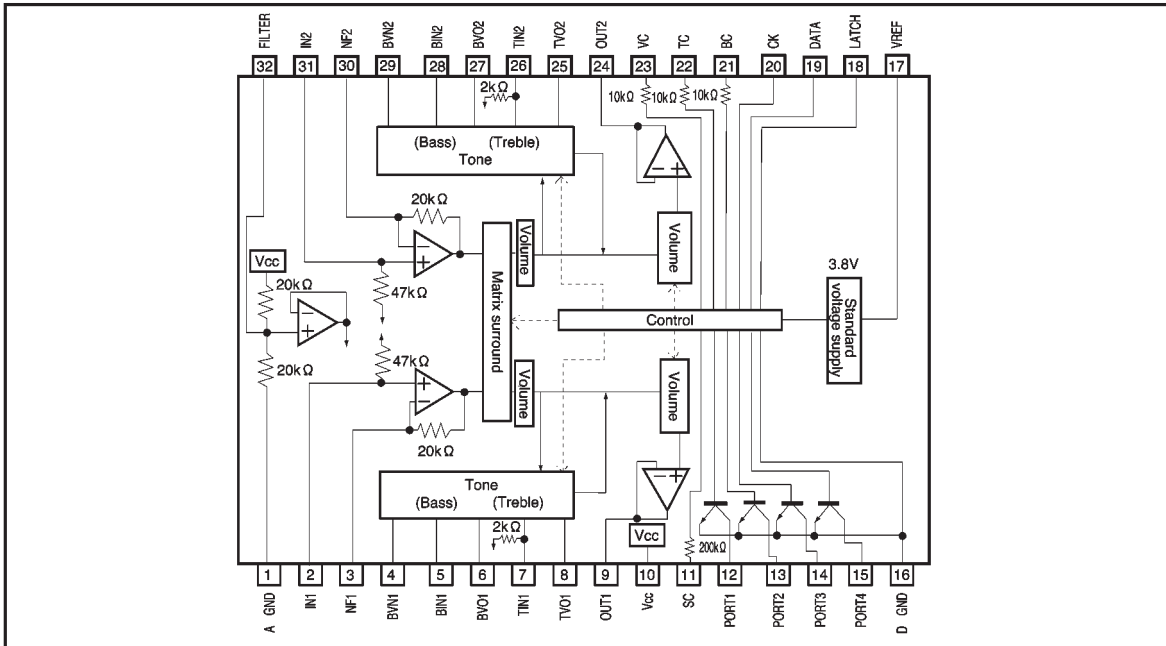

- * Supply of DC voltage from the VC (volume), BC (bass), TC (treble), and SC (surround) pins facilitates external control of volume, bass, treble, and surround.
- * Impedance at the VC, TC, and BC pins is 10 kΩ (Typ.).
- * Impedance at the SC pin is 200 kΩ (Typ.).

● Pin descriptions

Pin No.	Pin name	Function	Pin No.	Pin name	Function
1	A GND	Analog ground	17	VREF	Reference voltage output
2	IN1	Channel 1 volume input	18	LATCH	Latch input
3	NF1	Input-stage amplifier gain setting	19	DATA	Data input
4	BVN1	Channel 1 bass filter	20	CK	Clock input
5	BIN1	Channel 1 bass filter	21	BC	Time constant port for prevention of switching shock
6	BVO1	Channel 1 bass filter	22	TC	Time constant port for prevention of switching shock
7	TIN1	Channel 1 treble filter	23	VC	Time constant port for prevention of switching shock
8	TVO1	Channel 1 treble filter	24	OUT2	Channel 2 volume output
9	OUT1	Channel 1 volume output	25	TVO2	Channel 2 treble filter
10	Vcc	Power supply	26	TIN2	Channel 2 treble filter
11	SC	Time constant pin for prevention of switching shock	27	BVO2	Channel 2 bass filter
12	PORT1	Port output	28	BIN2	Channel 2 bass filter
13	PORT2	Port output	29	BVN2	Channel 2 bass filter
14	PORT3	Port output	30	NF2	Input-stage amplifier gain setting
15	PORT4	Port output	31	IN2	Channel 2 volume input
16	D GND	Digital ground	32	FILTER	Filter

- Electrical characteristics (unless otherwise noted, $T_a = 25^\circ\text{C}$, $V_{CC} = 8\text{V}$, $f = 1\text{kHz}$, $\text{BW} = 20 \sim 20\text{kHz}$,
VOL = Max., TONE = ALL FLAT, $R_g = 600\Omega$, $R_L = 10\text{k}\Omega$, INPUT AMP GAIN = 0dB)

Parameter	Symbol	Min.	Typ.	Max.	Unit	Conditions
Quiescent current	I_Q	8	17	25	mA	No signal
Maximum input	V_{im}	1.8	2.0	—	V_{rms}	THD=1%, VOL=-20dB(ATT)
Maximum output	V_{om}	1.8	2.0	—	V_{rms}	THD=1%
Voltage gain	G_V	-3.0	-1.0	1.0	dB	$V_{IN}=1V_{rms}$
Maximum attenuation	ATT	90	110	—	dB	$V_O=1V_{rms}$
Crosstalk	V_{CT}	64	70	—	dB	$V_O=1V_{rms}$, BPF=400Hz~30kHz
Low range control width	$V_{BMax.}$	12	15	18	dB	75Hz, $V_{IN}=100mV_{rms}$
	$V_{BMin.}$	-18	-15	-12	dB	75Hz, $V_{IN}=100mV_{rms}$
High range control width	$V_{TMax.}$	12	15	18	dB	10kHz, $V_{IN}=100mV_{rms}$
	$V_{TMin.}$	-18	-15	-12	dB	10kHz, $V_{IN}=100mV_{rms}$
Mute attenuation	V_{MT}	90	110	—	dB	$V_O=1V_{rms}$ *
Total harmonic distortion	THD	—	0.03	0.1	%	$V_O=0.3V_{rms}$, BPF=400Hz~30kHz
Output noise voltage	V_{NO1}	—	25	34	μV_{rms}	No signal, VOL=Max., $R_g=0$ *
Output noise voltage during full boost	V_{NO2}	—	80	120	μV_{rms}	No signal, TONE=ALL Max., VOL=Max., $R_g=0$ *
Residual output noise voltage	V_{MNO}	—	2	10	μV_{rms}	No signal, VOL=- ∞ , $R_g=0$ *
Reference power supply output voltage	V_{REF}	3.5	3.8	4.1	V	$I_{REF}=3\text{mA}$
Reference power supply output current power capacity	I_{REF}	3.0	10	—	mA	$V_{REF}>3.7\text{V}$
Channel balance	G_{CB}	-2.0	0	2.0	dB	CH1 taken as the standard for measurements.
Port output current	$I_{PMax.}$	5.0	—	—	mA	
Output low level voltage	V_{OL}	—	0.4	0.5	V	$I_{OL}=5\text{mA}$
H output disable current	I_{OZH}	—	—	1.0	μA	$V_O=5\text{V}$
Volume attenuation (-10 dB)	ATT10	-12.0	-10.0	-8.0	dB	$V_{IN}=0\text{dBV}$ is the gain when the control data (10101010) is entered.

*Measurement performed using Matsushita Communication Industrial VP-9690A DINAUDIO filter (average value wave detection, effective value display).

©Not designed for radiation resistance.

●Timing chart constants

Parameter	Symbol	Min.	Typ.	Max.	Unit
Input high level voltage	V_{IH}	4.0	5.0	6.0	V
Input low level voltage	V_{IL}	—	0	1.0	V
Min. clock width	t_w	2.0	—	—	μs
Min. data width	t_w (DATA)	2.0	—	—	μs
Min. latch width	t_w (LATCH)	2.0	—	—	μs
Setup time (DATA→CLK)	t_{su}	1.0	—	—	μs
Hold time (CLK→DATA)	t_h	1.0	—	—	μs
Setup time (CLK→LATCH)	t_s	1.0	—	—	μs

Note: About the output pins...

- Pins 1 through 4 (pins 12 through 15) are reset when the power is turned ON.
- After the pins are reset, until the V_{CC} voltage setting for this IC (BH3854) is reached and the next data is input, the pins only operate while the CK, DATA, and LATCH lines are all maintained at LOW.
- Be sure that no more than 9V is applied to any of the output pins.

● Measurement circuit

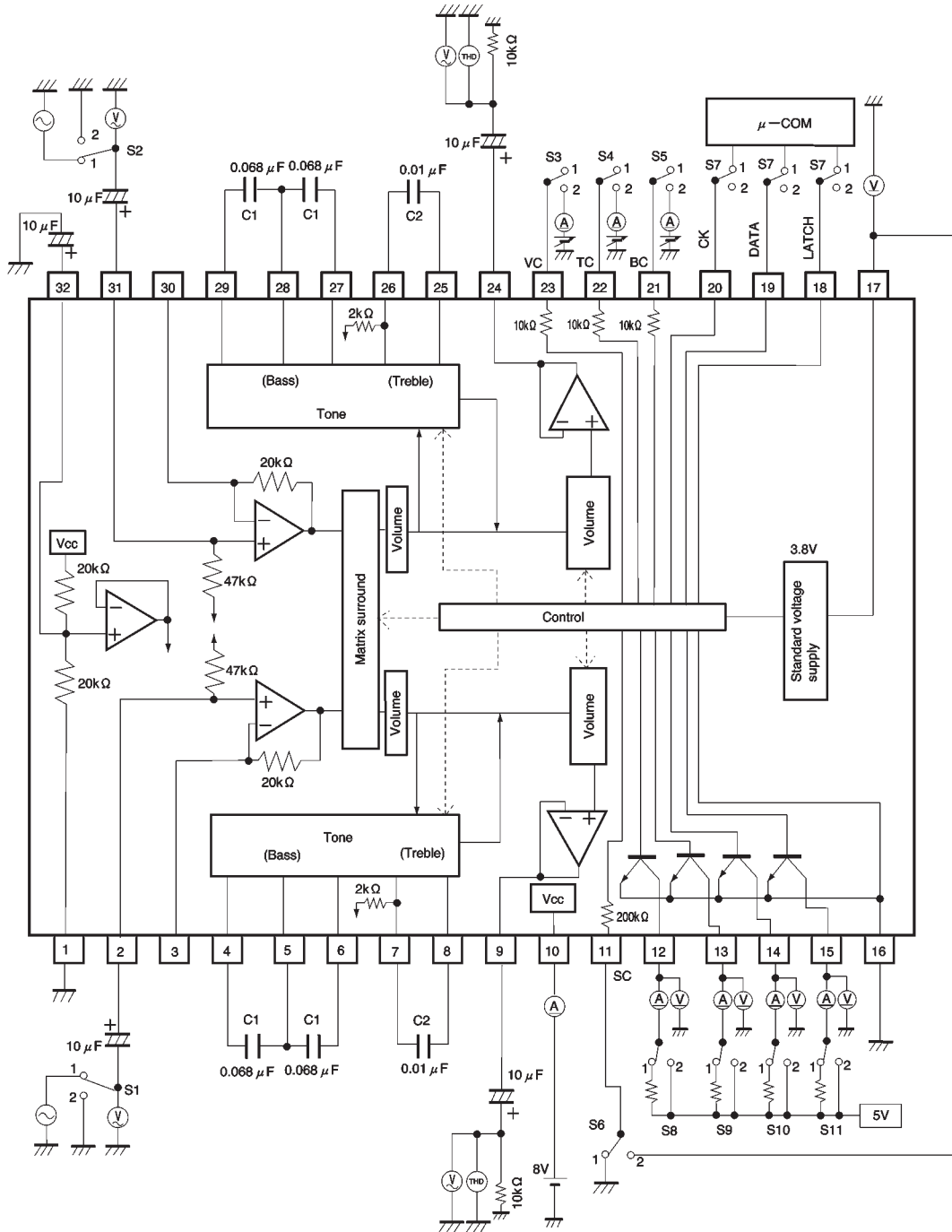

Fig. 1

● Operation of measuring circuit switches

Parameter	S1	S2	S3	S4	S5	S6	S7	S8	S9	S10	S11
Quiescent current	2	2	2A	2B	2B	2	2	1	1	1	1
Maximum input	↓	↓	2B	↓	↓	↓	↓	↓	↓	↓	↓
Maximum output	↓	↓	2A	↓	↓	↓	↓	↓	↓	↓	↓
Voltage gain	↓	↓	↓	↓	↓	↓	↓	↓	↓	↓	↓
Maximum attenuation	↓	↓	A→C	↓	↓	↓	↓	↓	↓	↓	↓
Crosstalk	1.2	2.1	2A	↓	↓	↓	↓	↓	↓	↓	↓
Low-band control width	Boost	1	1	↓	↓	2A	↓	↓	↓	↓	↓
	Cut	↓	↓	↓	↓	2C	↓	↓	↓	↓	↓
High-band control width	Boost	↓	↓	↓	2A	2B	↓	↓	↓	↓	↓
	Cut	↓	↓	↓	2C	↓	↓	↓	↓	↓	↓
Mute attenuation	↓	↓	A→C	2B	↓	↓	↓	↓	↓	↓	↓
Total harmonic distortion	↓	↓	2A	↓	↓	↓	↓	↓	↓	↓	↓
Output noise voltage	2	2	↓	↓	↓	↓	↓	↓	↓	↓	↓
Output noise voltage during full boost	↓	↓	↓	2A	2A	↓	↓	↓	↓	↓	↓
Residual output noise voltage	↓	↓	2C	2B	2B	↓	↓	↓	↓	↓	↓
Reference power supply output voltage	↓	↓	2A	↓	↓	↓	↓	↓	↓	↓	↓
Reference power supply output current power capacity	↓	↓	↓	↓	↓	↓	↓	↓	↓	↓	↓
Channel balance	1	1	↓	↓	↓	↓	↓	↓	↓	↓	↓
Port output current	2	2	↓	↓	↓	↓	1	↓	↓	↓	↓
Output low level voltage	↓	↓	↓	↓	↓	↓	↓	↓	↓	↓	↓
H output disable current	↓	↓	↓	↓	↓	↓	↓	2	2	2	2

*A, B, and C in the table represent the level of the variable voltage supply.

A = 3.8V

B = 1.9V

C = 0V

● Pin descriptions

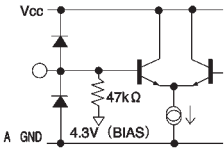
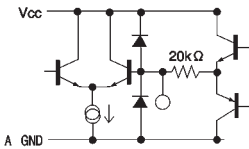
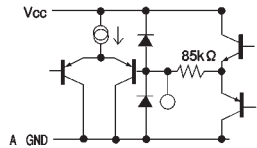
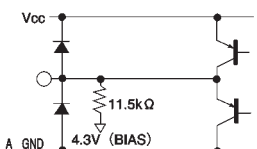
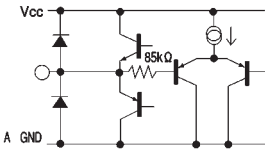
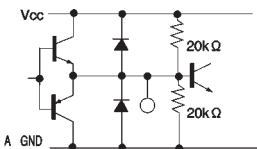
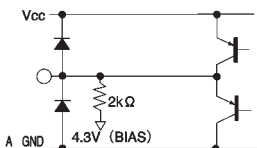
Symbol	Pin No.	Pin voltage	Equivalent circuit	Description
IN1 IN2	2pin 31pin	4.3V 4.3V		Main volume input pin. Designed for input impedance of 47 kΩ (Typ.).
NF1 NF2	3pin 30pin	4.3V 4.3V		Pin for adjustment of input amp gain. Approximately +6 dB with connection of 20 kΩ resistance.
BVN1 BVN2	4pin 29pin	4.3V 4.3V		Pin for low band filter connection.
BIN1 BIN2	5pin 28pin	4.3V 4.3V		Pin for low band filter connection.
BV01 BV02	6pin 27pin	4.3V 4.3V		Pin for low band filter connection.
FILTER	32pin	4.0V		Filter input pin. Filter input pin designed to operate at approximately 1/2 Vcc. Please install a capacitor of about 10 μF to the filter pin. Has built-in precharge and discharge circuits.
TIN1 TIN2	7pin 26pin	4.3V 4.3V		Pin for high band filter connection.

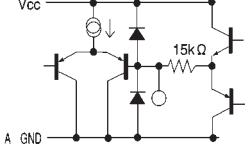
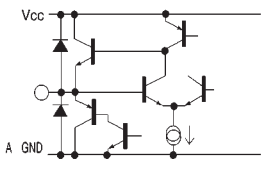
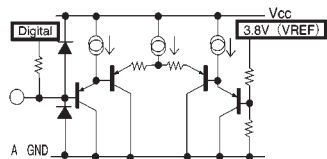
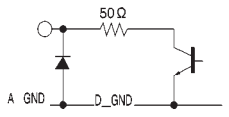
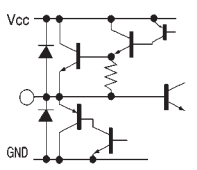
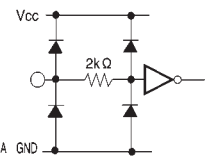
Symbol	Pin No.	Pin voltage	Equivalent circuit	Description
TV01 TV02	8pin 25pin	4.3V 4.3V		Pin for high band filter connection.
OUT1 OUT2	9pin 24pin	4.0V 4.0V		Main volume output pin. OUT1 is the volume output for Channel 1. OUT2 is the volume output for Channel 2.
SC BC TC VC	11pin 21pin 22pin 23pin	—		Time constant pin for prevention of switching shock noise SC : Surround pin BC : Bass pin TC : Treble pin VC : Volume pin
PORT1 PORT2 PORT3 PORT4	12pin 13pin 14pin 15pin	—		Output pin. Open collector output. Can pull a maximum of 5 mA.
V _{REF}	17pin	3.8V		3.8V regulator output pin. Output requires capacitor for stopping oscillation. Output pin has built-in precharge and discharge circuits, so there is no problem with start-up or shut-down even with a large capacitor.
LATCH DATA CK	18pin 19pin 20pin	—		Pin for receiving data from μ com. LATCH : latch line DATA : data line CK : clock line
V _{cc}	10pin	8V	Power supply voltage pin.	
A_GND	1pin	0V	Analog GND pin. Connected to IC board.	
D_GND	16pin	0V	Digital GND pin. Separate from Analog GND pin.	

Note: All figures for pin voltage assume a power supply voltage (V_{cc}) of 8V.

● Digital control specifications

(1) Data format: total of 23 bits

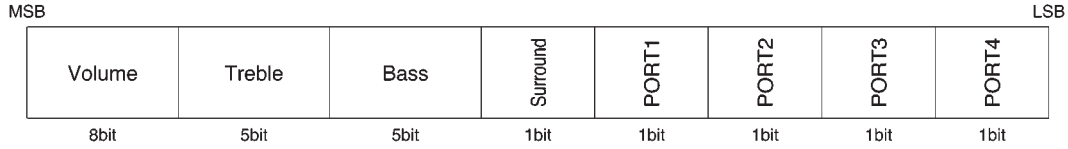

(2) Timing (recommended conditions)

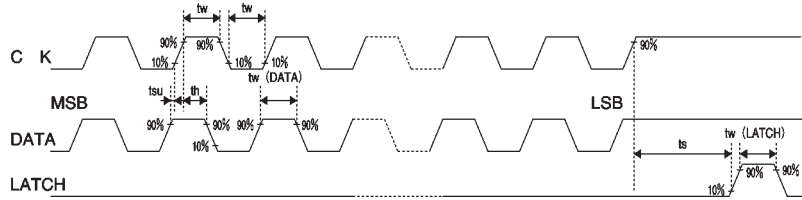

★For timing chart constants, see the electrical characteristics.

1) Surround is ON when the bit data is 0, and OFF when the bit data is 1.

2) Pins 1 through 4 are set so that the output transistors will turn OFF if data is not input when the power is turned ON. They turn ON when the bit data is 1, and OFF when the bit data is 0.

3) "H" level is 4V or greater. "L" level is 1V or less.

4) Make the end of each control command LOW.

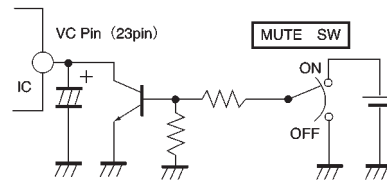

5) The MUTE function can be controlled externally if the VC (volume control) pin is configured as shown in the diagram above. Attenuation is equal to the figure for attenuation when volume is at M_{IN} .

● Volume data settings (reference values)

		MSB								LSB
HEX notation	Volume gain	V ₈	V ₇	V ₆	V ₅	V ₄	V ₃	V ₂	V ₁	
FF	0dB	1	1	1	1	1	1	1	1	
E5	-1dB	1	1	1	0	0	1	0	1	
DB	-2dB	1	1	0	1	1	0	1	1	
D3	-3dB	1	1	0	1	0	0	1	1	
CC	-4dB	1	1	0	0	1	1	0	0	
C6	-5dB	1	1	0	0	0	1	1	0	
C0	-6dB	1	1	0	0	0	0	0	0	
BA	-7dB	1	0	1	1	1	0	1	0	
B5	-8dB	1	0	1	1	0	1	0	1	
B0	-9dB	1	0	1	1	0	0	0	0	
AB	-10dB	1	0	1	0	1	0	1	1	
A7	-11dB	1	0	1	0	0	1	1	1	
A3	-12dB	1	0	1	0	0	0	1	1	
9F	-13dB	1	0	0	1	1	1	1	1	
9C	-14dB	1	0	0	1	1	1	0	0	
98	-15dB	1	0	0	1	1	0	0	0	
95	-16dB	1	0	0	1	0	1	0	1	
91	-17dB	1	0	0	1	0	0	0	1	
8E	-18dB	1	0	0	0	1	1	1	0	
8A	-19dB	1	0	0	0	1	0	1	0	

HEX notation	Volume gain	MSB							LSB	
		V ₈	V ₇	V ₆	V ₅	V ₄	V ₃	V ₂	V ₁	
87	-20dB	1	0	0	0	0	1	1	1	
81	-22dB	1	0	0	0	0	0	0	1	
7B	-24dB	0	1	1	1	1	0	1	1	
75	-26dB	0	1	1	1	0	1	0	1	
70	-28dB	0	1	1	1	0	0	0	0	
6B	-30dB	0	1	1	0	1	0	1	1	
66	-32dB	0	1	1	0	0	1	1	0	
62	-34dB	0	1	1	0	0	0	1	0	
5D	-36dB	0	1	0	1	1	1	0	1	
59	-38dB	0	1	0	1	1	0	0	1	
55	-40dB	0	1	0	1	0	1	0	1	
51	-42dB	0	1	0	1	0	0	0	1	
4D	-44dB	0	1	0	0	1	1	0	1	
4A	-46dB	0	1	0	0	1	0	1	0	
47	-48dB	0	1	0	0	0	1	1	1	
43	-50dB	0	1	0	0	0	0	1	1	
40	-52dB	0	1	0	0	0	0	0	0	
3D	-54dB	0	0	1	1	1	1	0	1	
3A	-56dB	0	0	1	1	1	0	1	0	
37	-58dB	0	0	1	1	0	1	1	1	
34	-60dB	0	0	1	1	0	1	0	0	
32	-62dB	0	0	1	1	0	0	1	0	
2F	-64dB	0	0	1	0	1	1	1	1	
2D	-66dB	0	0	1	0	1	1	0	1	
2B	-68dB	0	0	1	0	1	0	1	1	
28	-70dB	0	0	1	0	1	0	0	0	
26	-72dB	0	0	1	0	0	1	1	0	
24	-74dB	0	0	1	0	0	1	0	0	
23	-76dB	0	0	1	0	0	0	1	1	
21	-78dB	0	0	1	0	0	0	0	1	
1F	-80dB	0	0	0	1	1	1	1	1	
1E	-82dB	0	0	0	1	1	1	1	0	
1C	-84dB	0	0	0	1	1	1	0	0	
00	-∞	0	0	0	0	0	0	0	0	

Note: All figures in this table are reference values. When using this IC, check this table carefully and perform the appropriate setting.

● Treble settings (reference values)

Treble data

MSB	Settings				LSB	Treble gain (dB)	HEX notation
0	0	0	0	0		-15	00
0	0	1	0	0		-14	04
0	0	1	1	0		-12	06
0	1	0	0	0		-10	08
0	1	0	0	1		-8	09
0	1	0	1	0		-6	0A
0	1	0	1	1		-4	0B
0	1	1	0	0		-2	0C
0	1	1	1	1		±0	0F
1	0	1	0	0		+2	14
1	0	1	0	1		+4	15
1	0	1	1	0		+6	16
1	0	1	1	1		+8	17
1	1	0	0	0		+10	18
1	1	0	1	0		+12	1A
1	1	1	0	0		+14	1C
1	1	1	1	1		+15	1F

Bass data

MSB	Settings				LSB	Bass gain (dB)	HEX notation
0	0	0	0	0		-15	00
0	0	1	0	1		-14	05
0	0	1	1	1		-12	07
0	1	0	0	1		-10	09
0	1	0	1	0		-8	0A
0	1	0	1	1		-6	0B
0	1	1	0	0		-4	0C
0	1	1	0	1		-2	0D
0	1	1	1	1		±0	0F
1	0	0	1	1		+2	13
1	0	1	0	0		+4	14
1	0	1	0	1		+6	15
1	0	1	1	0		+8	16
1	0	1	1	1		+10	17
1	1	0	0	1		+12	19
1	1	0	1	1		+14	1B
1	1	1	1	1		+15	1F

Notes:1. The gain values in the treble and bass data setting tables above are based on the assumption that the filter constants have been set so that maximum and minimum gain are equal to the peak and bottom values listed in the frequency characteristics drawings.

2. All figures in this table are reference values. When using this IC, check this table carefully and perform the appropriate setting.

● Application example

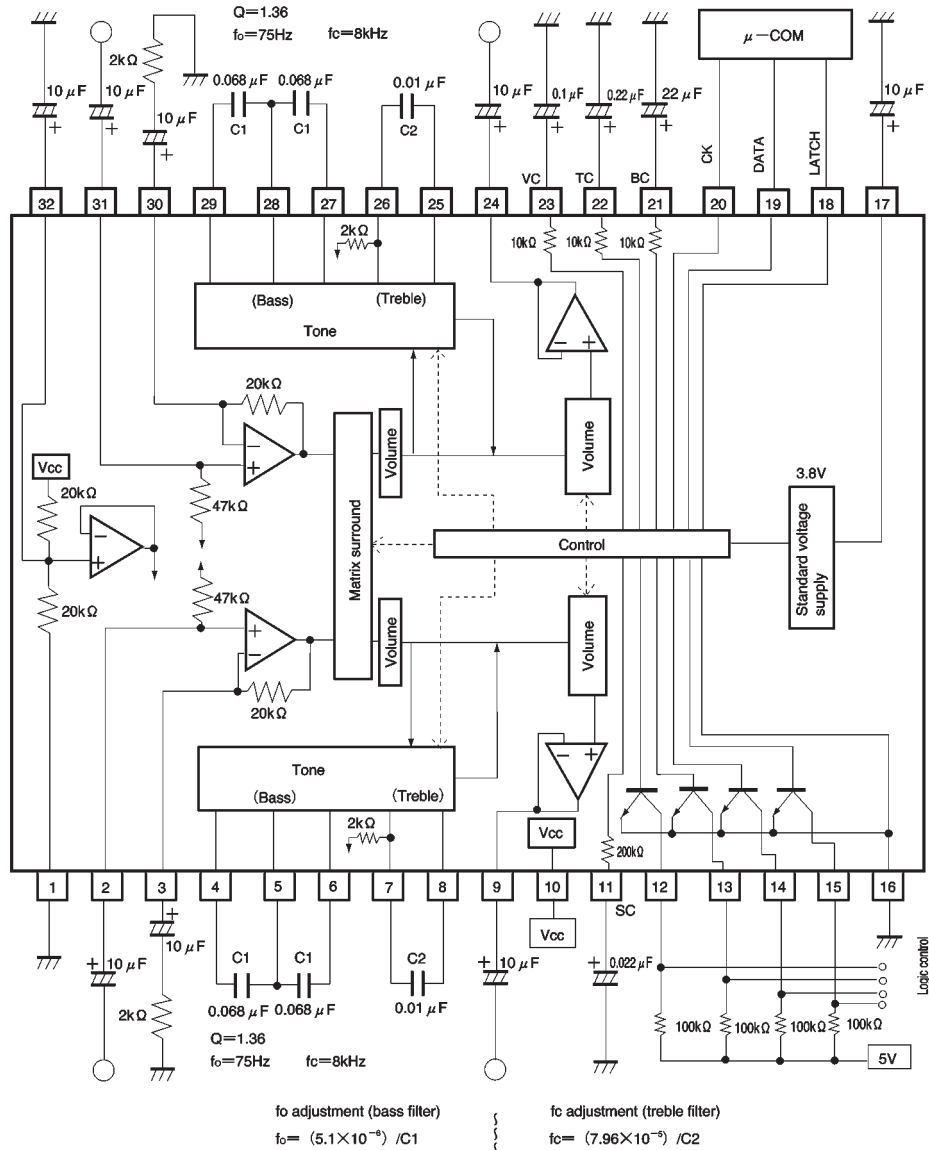

Fig. 2

● Operation notes

(1) Operating power supply voltage range

As long as the operating power supply voltage and ambient temperature are kept within the specified range, the basic circuits are guaranteed to function, but be sure to check the constants as well as the element settings, voltage settings, and temperature settings. Also, please take into consideration internal IC resistance dispersion (approx. ±20%) and temperature fluctuation when making settings for IC internal resistance, attachment resistance, capacitor gain, or frequency.

(2) Primary amp

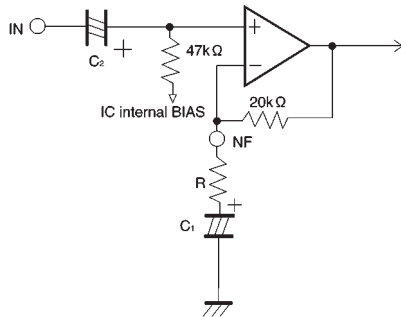

- 1) The input impedance is 47kΩ.
- 2) A buffer if R and C₁ are not present.
- 3) The gain can be set by R and the 20kΩ.

$$G_{VC} = (R + 20k\Omega) / R$$

Note: Set C₂ (input coupling) and C₁ (used to set the gain) depending on the frequency band used.

(3) Bass filter

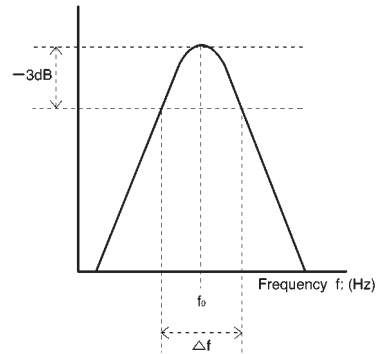
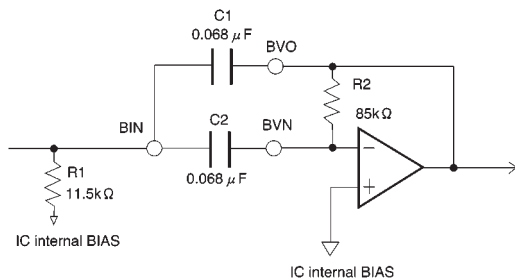

- 1) The BPF is composed of a multifeedback active filter. f₀ can be varied according to the value of C.
- (theoretical equation)

$$f_0 = \frac{1}{2\pi} \times \left[\frac{1}{R_1 R_2 C_1 C_2} \right]^{\frac{1}{2}}$$

$$G = \frac{R_2}{5k\Omega} \times \left[1 + \frac{C_1}{C_2} \right]^{-1}$$

(When R₁ = 11.5kΩ, R₂ = 85kΩ, C₁ = C₂ = C)

$$f_0 = \frac{5.1 \times 10^{-6}}{C} \quad Q \cong 1.36 \quad G \cong 8.5$$

$$Q \cong \left[\left(\frac{R_1}{R_2 C_1 C_2} \right)^{\frac{1}{2}} \times (C_1 + C_2) \right]^{-1}$$

Note: Filter gain is calculated using the equation above. Total output gain is the sum of the gain for each of the internal circuits.

(4) Treble filter

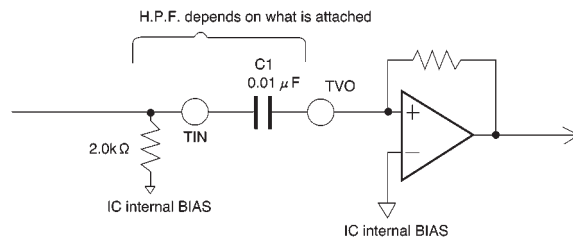

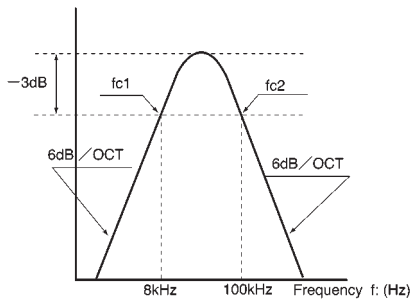

- Cutoff frequency (f_{c1}) for the bypass filter can be changed using the attached C_1 .

$$f_{c1} = \frac{1}{2\pi \times C_1 \times 2k\Omega}$$

The f_{c1} for the recommended constant is approximately 8kHz.

- f_{c2} is determined by the band of the built-in amp. f_{c2} is approximately 100kHz.

The tone control is designed for a fluctuation of ± 15 dB (Typ.) when the frequency that you want to boost or cut is a peak or valley of the frequency characteristics for the filter. So be sure to design the filter while taking into consideration its frequency characteristics.

(5) Tone boost

When volume attenuation increases, tone control width will change. Reference values are listed below, but be aware that actual values vary for different products. (Reference values)

At attenuation of 0dB, tone control width is ± 15.0 dB.
 At attenuation of -40 dB, tone control width is ± 13.5 dB.

(6) Signal level setting

The following figure represents the standard setting for the BH3854A.

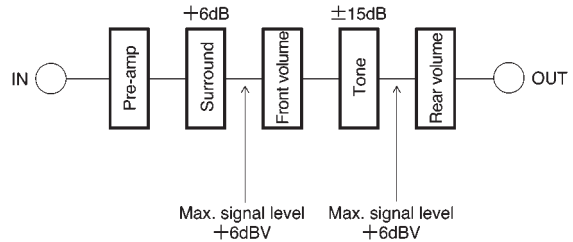

As indicated above, if the front volume and rear volume input level are set so as not to exceed $+6$ dBV ($2 V_{rms}$), the pre-amp gain setting can be used to improve the S/N ratio.

The figure on the left is a level diagram.

Solid line: Input level during tone boost.

Dotted line: Input level during tone cut.

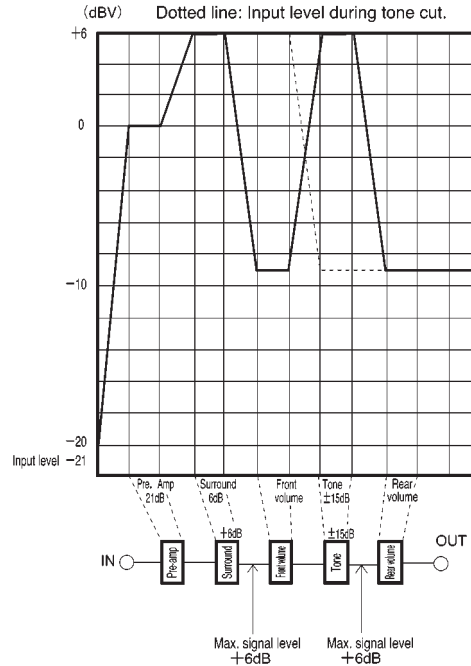

(7) Serial control

High-frequency digital signals are input into the CK, DATA, and LATCH pins. Configure the wiring for these pins in such a manner that it does not create interference for lines carrying analog signals. When measuring for step switching noise caused by interference, connect in serial format resistance of approximately 2 kΩ right next to the microcomputer output pin (CK, DATA, LATCH) for each line.

(8) Step switching noise

In the circuit of the sample application, a constant is given, as an example, to each of the VC (pin 23), TC (pin 22), BC (pin 21), and SC (pin 11) pins. These constants vary depending upon signal level settings, wiring patterns in the device to which they are mounted, etc. Consider each constant carefully. The following diagram depicts an internal equivalent circuit. (It is equipped with a primary integration circuit so that changes will occur slowly.)

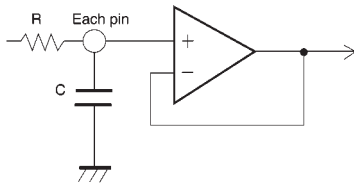

	R value (kΩ)
VC, BC, TC	10
SC	200

(9) Setting the volume and tone levels

These specifications include, as reference values, figures for attenuation or gain for control serial data. The internal D/A converter features an R-2R structure, thus when there is no change between consecutive data, data exists. This can be used when very fine settings must be made, provided that volume is 8 bits (256 steps) or fewer, and tone is 5 bits (32 steps) or fewer.

(10) D/A separation

With this IC (BH3854AS / AFS), the analog and digital systems are completely separated in the power supply and GND. Within the digital system, there is a stable built-in standard voltage supply, all of which is supplied via the VREF (pin 17, 3.8V), so this IC can be used without any worry about timing being off or digital noise interference occurring.

(11) Output pins

PORT 1 through 4 (pins 12 through 15) are reset when the power is turned ON, and remain reset until the next serial data is input.

Note: From the time the power is turned ON until the next data is input, data in the CK, DATA, and LATCH lines are all maintained at LOW.

- Be sure that no more than 9V is applied to any of the output pins.

(12) Matrix surround

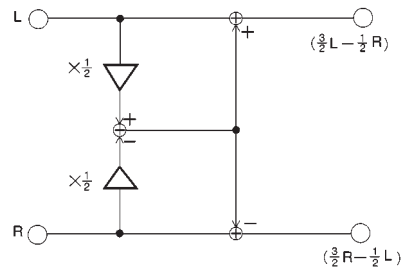

© The structure of the matrix surround is as shown in the figure above. Use the equations shown in the figure to calculate gain.

In-phase gain	0dB
Negative-phase gain	3.5dB

(Negative-phase gain only occurs when input is carried out on single Ch.)

(13) DC control

There is internal impedance of 10kΩ at the VC (pin 23), TC (pin 22), and BC (pin 21) pins, and internal impedance of 200kΩ at the SC pin (pin 11). For this reason, it is recommended that DC control of these pins be performed by voltage delivered directly from the voltage source. When using variable volume, take the impedance into account in determining the settings.

Note: The voltage range for DC control is 0V to 3.8V. Be sure not to apply greater than 3.8V to any pin.

(14) GND

- Connect the GND of the attached element, which is shown in the circuit of the sample application, to the analog GND.
- Connect the GND of the capacitor that is connected to pin 17 to the digital GND.
- If several capacitors with good high-frequency characteristics are connected in parallel to the 17th-pin capacitor, the characteristics will be improved with respect to static electricity noise. (Recommended: ceramic capacitors of 0.001μF to 0.1μF) If the wiring to the analog GND and digital GND is long, make sure that no potential difference arises between the two GNDs.

teristics are connected in parallel to the 17th-pin capacitor, the characteristics will be improved with respect to static electricity noise. (Recommended: ceramic capacitors of 0.001μF to 0.1μF) If the wiring to the analog GND and digital GND is long, make sure that no potential difference arises between the two GNDs.

(15) BH3854AS → BH3854AFS: Differences

- The bass filter R₂ constant changes from 100 kΩ → 85 kΩ. Accordingly, bass filter f₀ changes from 70Hz → 75Hz, which means bass filter Q changes from 1.47 → 1.36.
- The resistance at the treble filter's TIN pin changes from 20 kΩ → 2 kΩ. Accordingly, the value for the attached capacitor changes from 470pF → 0.01μF, which means that cutoff frequency (f_{c1}) changes from 17kHz → 8kHz.

● Electrical characteristic curves

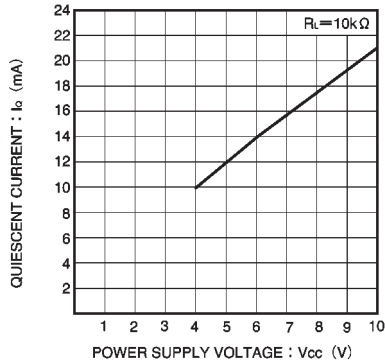

Fig. 3 Quiescent curve vs. power supply voltage

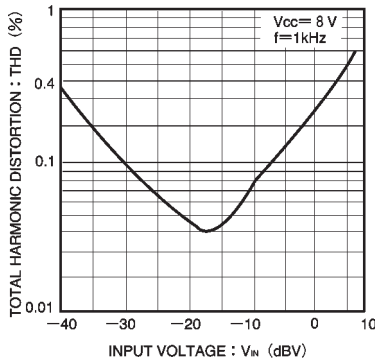

Fig. 4 Harmonic distortion vs. input voltage

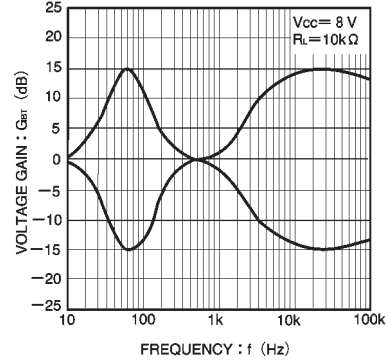

Fig. 5 Output gain vs. frequency

● External dimensions (Units: mm)

