



RF Power Field Effect Transistors

N-Channel Enhancement-Mode Lateral MOSFETs

Designed for class AB PCN and PCS base station applications with frequencies from 1800 to 2000 MHz. Suitable for FM, TDMA, CDMA and multicarrier amplifier applications.

- CDMA Performance @ 1990 MHz, 26 Volts
 IS-95 CDMA Pilot, Sync, Paging, Traffic Codes 8 Thru 13
 885 kHz — -47 dBc in 30 kHz BW
 1.25 MHz — -55 dBc in 12.5 kHz BW
 2.25 MHz — -55 dBc in 1 MHz BW
 Output Power — 4.5 Watts Avg.
 Power Gain — 13.5 dB
 Efficiency — 17%
- Capable of Handling 10:1 VSWR, @ 26 Vdc, 1960 MHz, 30 Watts CW Output Power

Features

- Internally Matched for Ease of Use
- High Gain, High Efficiency and High Linearity
- Integrated ESD Protection
- Designed for Maximum Gain and Insertion Phase Flatness
- Excellent Thermal Stability
- Characterized with Series Equivalent Large-Signal Impedance Parameters
- Low Gold Plating Thickness on Leads, 40μ" Nominal.
- RoHS Compliant
- In Tape and Reel. R3 Suffix = 250 Units per 32 mm, 13 Inch Reel.

MRF19030LR3
MRF19030LSR3

1930-1990 MHz, 30 W, 26 V
LATERAL N-CHANNEL
RF POWER MOSFETs

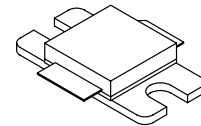

CASE 465E-04, STYLE 1
NI-400
MRF19030LR3

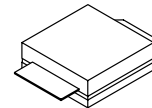

CASE 465F-04, STYLE 1
NI-400S
MRF19030LSR3

Table 1. Maximum Ratings

Rating	Symbol	Value	Unit
Drain-Source Voltage	V_{DSS}	-0.5, +65	Vdc
Gate-Source Voltage	V_{GS}	-0.5, +15	Vdc
Total Device Dissipation @ $T_C = 25^\circ\text{C}$ Derate above 25°C	P_D	83.3 0.48	W W/ $^\circ\text{C}$
Storage Temperature Range	T_{stg}	- 65 to +150	$^\circ\text{C}$
Case Operating Temperature	T_C	150	$^\circ\text{C}$
Operating Junction Temperature	T_J	200	$^\circ\text{C}$

Table 2. Thermal Characteristics

Characteristic	Symbol	Value	Unit
Thermal Resistance, Junction to Case	$R_{\theta JC}$	2.1	$^\circ\text{C}/\text{W}$

Table 3. ESD Protection Characteristics

Test Conditions	Class
Human Body Model	2 (Minimum)
Machine Model	M3 (Minimum)

Table 4. Electrical Characteristics ($T_C = 25^\circ\text{C}$ unless otherwise noted)

Characteristic	Symbol	Min	Typ	Max	Unit
Off Characteristics					
Drain-Source Breakdown Voltage ($V_{GS} = 0\text{ Vdc}$, $I_D = 20\ \mu\text{A}$)	$V_{(BR)DSS}$	65	—	—	Vdc
Zero Gate Voltage Drain Current ($V_{DS} = 28\text{ Vdc}$, $V_{GS} = 0\text{ Vdc}$)	I_{DSS}	—	—	1	μAdc
Gate-Source Leakage Current ($V_{GS} = 5\text{ Vdc}$, $V_{DS} = 0\text{ Vdc}$)	I_{GSS}	—	—	1	μAdc
On Characteristics					
Gate Threshold Voltage ($V_{DS} = 10\text{ Vdc}$, $I_D = 100\ \mu\text{Adc}$)	$V_{GS(th)}$	2	3	4	Vdc
Gate Quiescent Voltage ($V_{DS} = 28\text{ Vdc}$, $I_D = 300\text{ mA}$)	$V_{GS(Q)}$	2	3.3	4.5	Vdc
Drain-Source On-Voltage ($V_{GS} = 10\text{ Vdc}$, $I_D = 1\text{ Adc}$)	$V_{DS(on)}$	—	0.29	0.4	Vdc
Forward Transconductance ($V_{DS} = 10\text{ Vdc}$, $I_D = 1\text{ Adc}$)	g_{fs}	—	2	—	S
Dynamic Characteristics					
Input Capacitance (Including Input Matching Capacitor in Package) (1) ($V_{DS} = 26\text{ Vdc}$, $V_{GS} = 0$, $f = 1\text{ MHz}$)	C_{iss}	—	98.5	—	pF
Output Capacitance (1) ($V_{DS} = 26\text{ Vdc}$, $V_{GS} = 0$, $f = 1\text{ MHz}$)	C_{oss}	—	37	—	pF
Reverse Transfer Capacitance ($V_{DS} = 26\text{ Vdc}$, $V_{GS} = 0$, $f = 1\text{ MHz}$)	C_{rss}	—	1.3	—	pF
Functional Tests (In Freescale Test Fixture, 50 ohm system)					
Two-Tone Common-Source Amplifier Power Gain ($V_{DD} = 26\text{ Vdc}$, $P_{out} = 30\text{ W PEP}$, $I_{DQ} = 300\text{ mA}$, $f_1 = 1960.0\text{ MHz}$, $f_2 = 1960.1\text{ MHz}$)	G_{ps}	—	13	—	dB
Two-Tone Drain Efficiency ($V_{DD} = 26\text{ Vdc}$, $P_{out} = 30\text{ W PEP}$, $I_{DQ} = 300\text{ mA}$, $f_1 = 1960.0\text{ MHz}$, $f_2 = 1960.1\text{ MHz}$)	η	—	36	—	%
3rd Order Intermodulation Distortion ($V_{DD} = 26\text{ Vdc}$, $P_{out} = 30\text{ W PEP}$, $I_{DQ} = 300\text{ mA}$, $f_1 = 1960.0\text{ MHz}$, $f_2 = 1960.1\text{ MHz}$)	IMD	—	-31	—	dBc
Input Return Loss ($V_{DD} = 26\text{ Vdc}$, $P_{out} = 30\text{ W PEP}$, $I_{DQ} = 300\text{ mA}$, $f_1 = 1960.0\text{ MHz}$, $f_2 = 1960.1\text{ MHz}$)	IRL	—	-13	—	dB
Two-Tone Common-Source Amplifier Power Gain ($V_{DD} = 26\text{ Vdc}$, $P_{out} = 30\text{ W PEP}$, $I_{DQ} = 300\text{ mA}$, $f_1 = 1930.0\text{ MHz}$, $f_2 = 1930.1\text{ MHz}$ and $f_1 = 1990.0\text{ MHz}$, $f_2 = 1990.1\text{ MHz}$)	G_{ps}	12	13	—	dB
Two-Tone Drain Efficiency ($V_{DD} = 26\text{ Vdc}$, $P_{out} = 30\text{ W PEP}$, $I_{DQ} = 300\text{ mA}$, $f_1 = 1930.0\text{ MHz}$, $f_2 = 1930.1\text{ MHz}$ and $f_1 = 1990.0\text{ MHz}$, $f_2 = 1990.1\text{ MHz}$)	η	33	36	—	%
3rd Order Intermodulation Distortion ($V_{DD} = 26\text{ Vdc}$, $P_{out} = 30\text{ W PEP}$, $I_{DQ} = 300\text{ mA}$, $f_1 = 1930.0\text{ MHz}$, $f_2 = 1930.1\text{ MHz}$ and $f_1 = 1990.0\text{ MHz}$, $f_2 = 1990.1\text{ MHz}$)	IMD	—	-31	-28	dBc
Input Return Loss ($V_{DD} = 26\text{ Vdc}$, $P_{out} = 30\text{ W PEP}$, $I_{DQ} = 300\text{ mA}$, $f_1 = 1930.0\text{ MHz}$, $f_2 = 1930.1\text{ MHz}$ and $f_1 = 1990.0\text{ MHz}$, $f_2 = 1990.1\text{ MHz}$)	IRL	—	-13	-9	dB

1. Part is internally matched both on input and output.

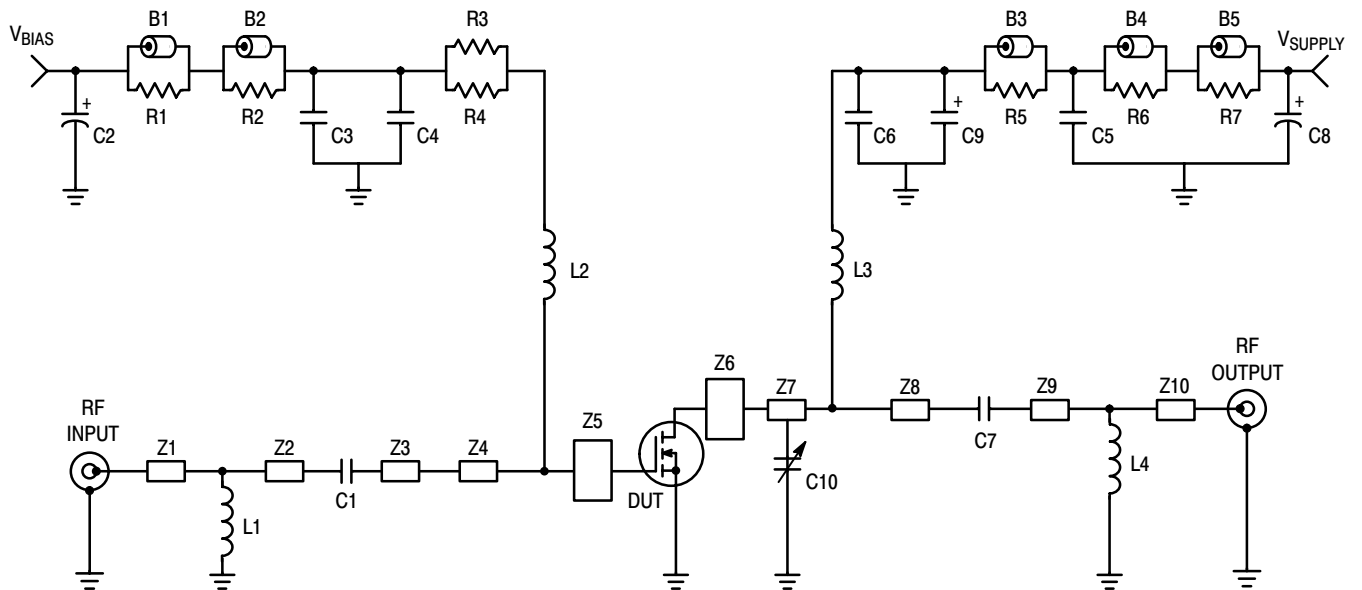

B1 - B5	Short Ferrite Beads	Z3	0.080" x 0.480" Microstrip
C1, C7	10 pF Chip Capacitors	Z4	0.325" x 0.280" Microstrip
C2, C8	470 μ F, 35 V Electrolytic Capacitors	Z5	0.510" x 0.200" Microstrip
C3, C5	0.1 μ F Chip Capacitors	Z6	0.510" x 0.200" Microstrip
C4, C6	5.1 pF Chip Capacitors	Z7	0.325" x 0.280" Microstrip
C9	22 μ F Tantalum Chip Capacitor	Z8	0.080" x 0.480" Microstrip
C10	0.4 - 2.5 pF Variable Capacitor, Johanson Gigatrim	Z9	0.080" x 0.530" Microstrip
L1 - L4	12.5 nH Inductors	Z10	0.080" x 0.671" Microstrip
R1 - R7	12 Ω Chip Resistors (0805)	Substrate	0.030" x 3.00" x 5.00" Glass Teflon [®] , Arlon
Z1	0.080" x 0.595" Microstrip		
Z2	0.080" x 0.600" Microstrip		

Figure 1. MRF19030LR3(SR3) Test Circuit Schematic

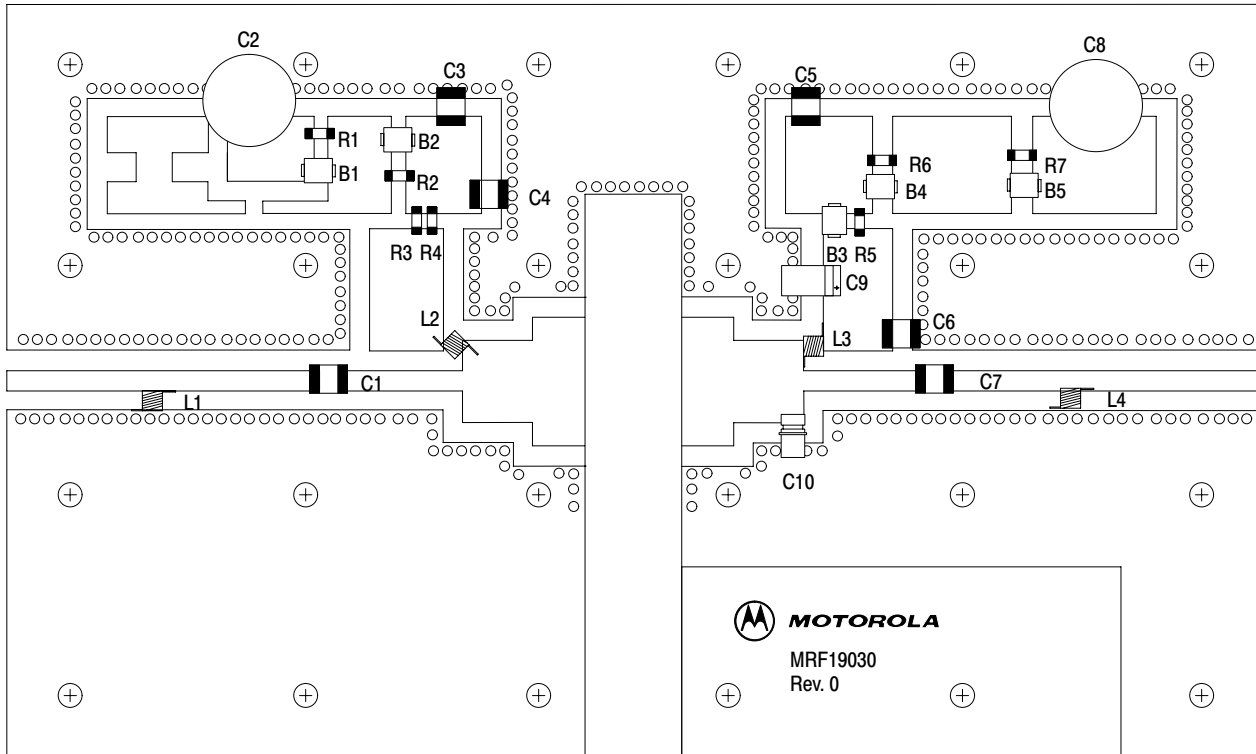

Freescale has begun the transition of marking Printed Circuit Boards (PCBs) with the Freescale Semiconductor signature/logo. PCBs may have either Motorola or Freescale markings during the transition period. These changes will have no impact on form, fit or function of the current product.

Figure 2. MRF19030LR3(SR3) Test Circuit Component Layout

TYPICAL CHARACTERISTICS

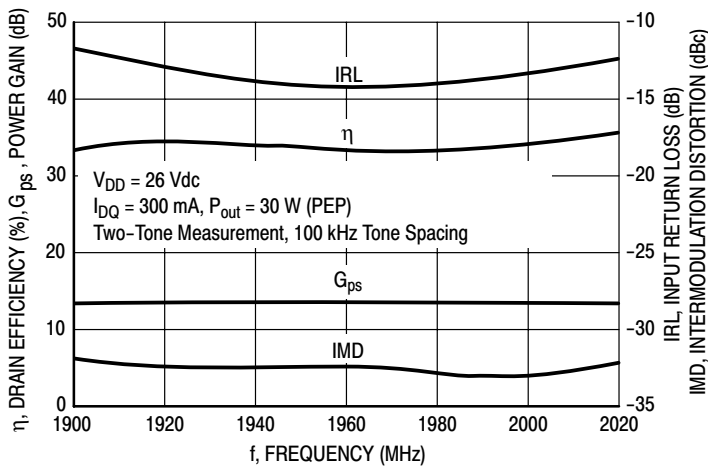

Figure 3. Class AB Broadband Circuit Performance

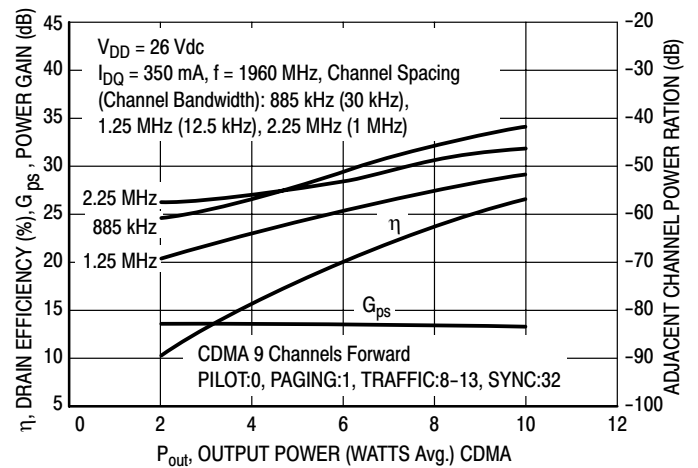

Figure 4. CDMA ACPR, Power Gain and Drain Efficiency versus Output Power

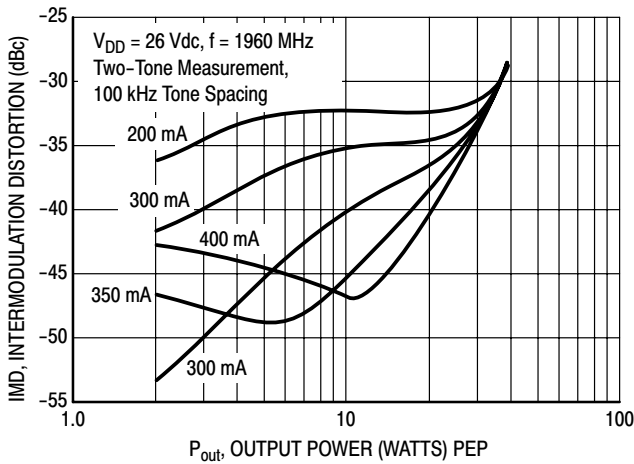

Figure 5. Intermodulation Distortion versus Output Power

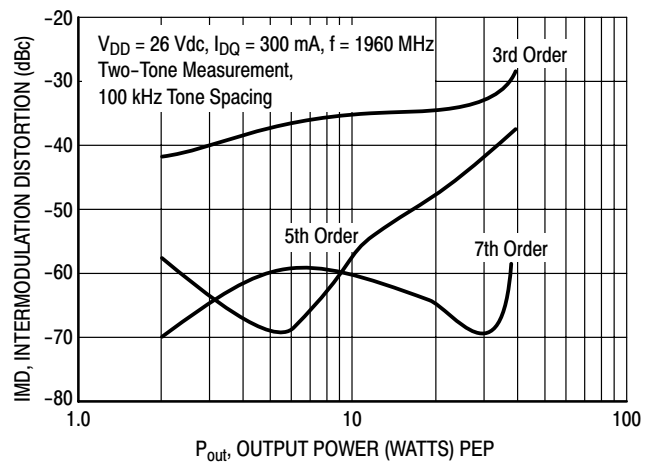

Figure 6. Intermodulation Distortion Products versus Output Power

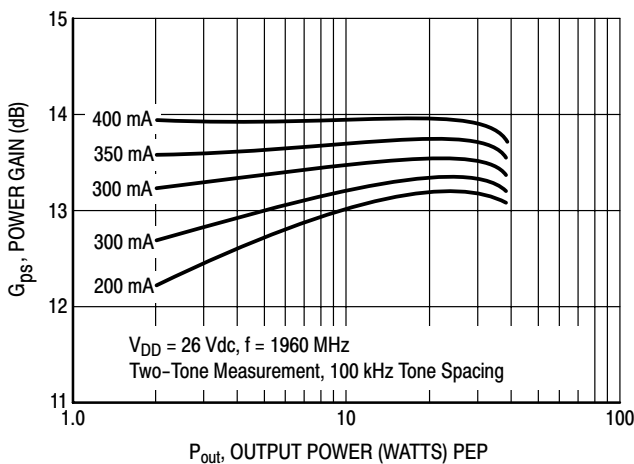

Figure 7. Power Gain versus Output Power

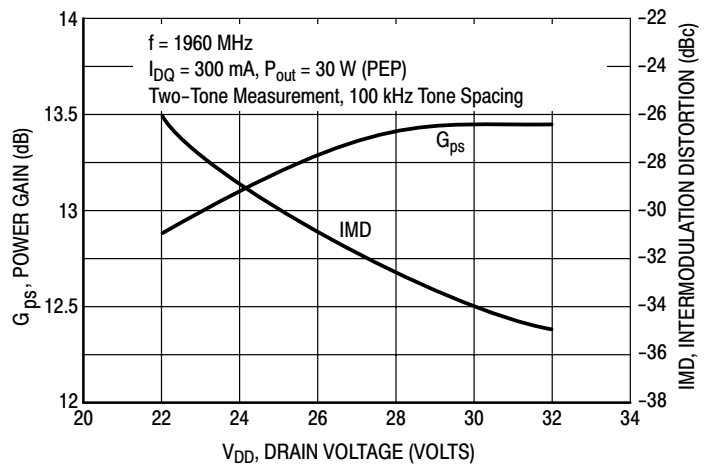
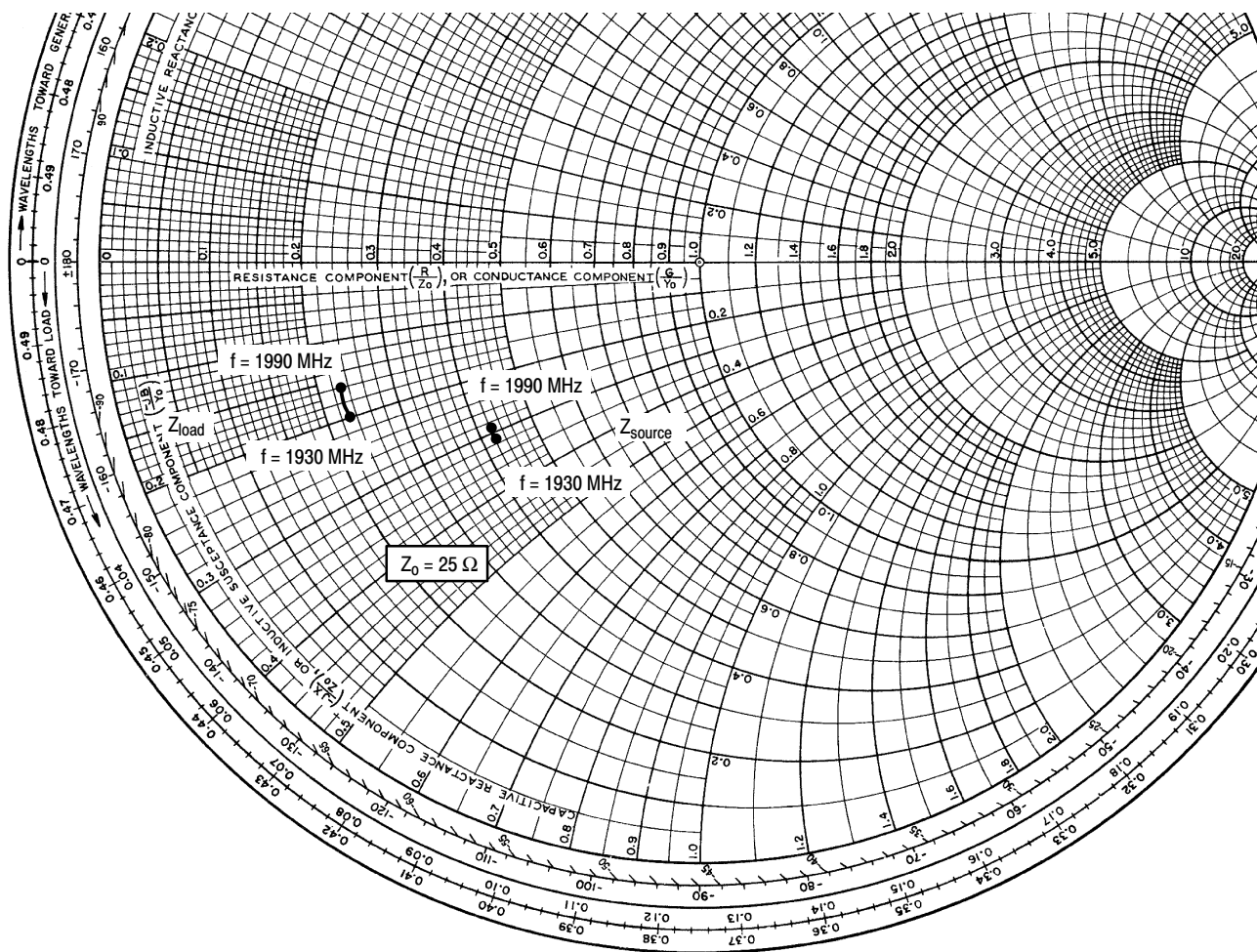

Figure 8. Power Gain and Intermodulation Distortion versus Supply Voltage

MRF19030LR3 MRF19030LSR3



$V_{DD} = 26\text{ V}$, $I_{DQ} = 300\text{ mA}$, $P_{out} = 30\text{ W PEP}$

f MHz	Z_{source} Ω	Z_{load} Ω
1930	$10.57 - j7.69$	$5.81 - j5.01$
1960	$10.54 - j7.43$	$5.84 - j4.67$
1990	$10.47 - j7.21$	$5.84 - j4.35$

Z_{source} = Test circuit impedance as measured from gate to ground.

Z_{load} = Test circuit impedance as measured from drain to ground.

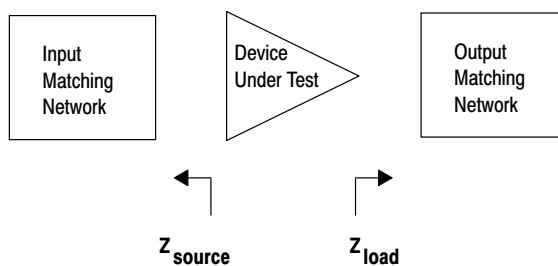
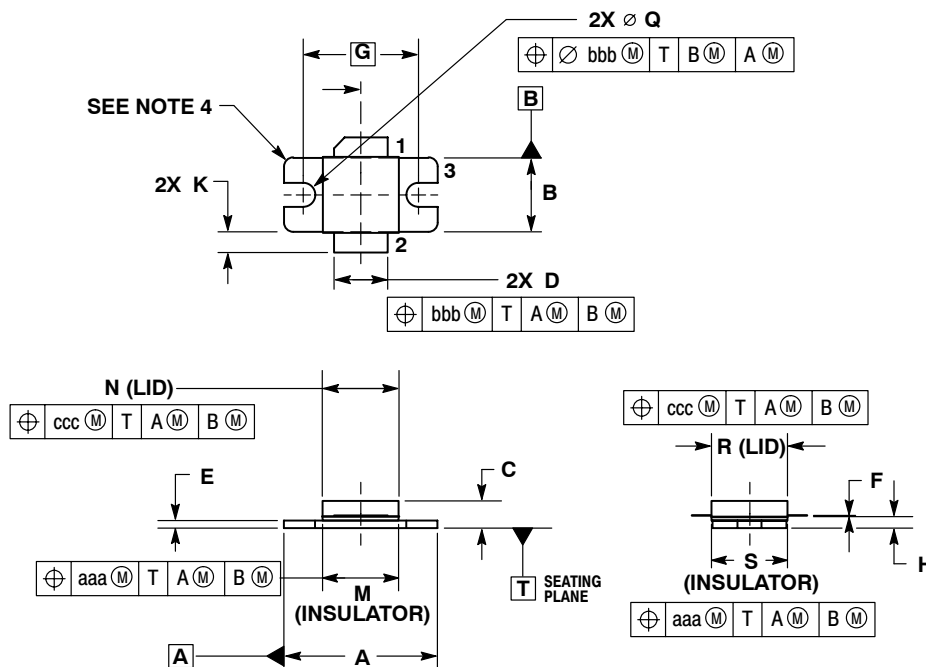

Figure 9. Series Equivalent Source and Load Impedance

PACKAGE DIMENSIONS



- NOTES:
1. CONTROLLING DIMENSION: INCH.
 2. INTERPRET DIMENSIONS AND TOLERANCES PER ASME Y14.5M, 1994.
 3. DIMENSION H IS MEASURED 0.030 (0.762) AWAY FROM PACKAGE BODY.
 4. INFORMATION ONLY: CORNER BREAK (4X) TO BE .060±.005 (1.52±0.13) RADIUS OR .06±.005 (1.52±0.13) x 45° CHAMFER.

DIM	INCHES		MILLIMETERS	
	MIN	MAX	MIN	MAX
A	.795	.805	20.19	20.44
B	.380	.390	9.65	9.9
C	.125	.163	3.17	4.14
D	.275	.285	6.98	7.24
E	.035	.045	0.89	1.14
F	.004	.006	0.10	0.15
G	.600 BSC		15.24 BSC	
H	.057	.067	1.45	1.7
K	.092	.122	2.33	3.1
M	.395	.405	10	10.3
N	.395	.405	10	10.3
Q	$\varnothing .120$	$\varnothing .130$	$\varnothing 3.05$	$\varnothing 3.3$
R	.395	.405	10	10.3
S	.395	.405	10	10.3
aaa	.005 BSC		0.127 BSC	
bbb	.010 BSC		0.254 BSC	
ccc	.015 BSC		0.381 BSC	

- STYLE 1:
 PIN 1. DRAIN
 2. GATE
 3. SOURCE

**CASE 465E-04
 ISSUE F
 NI-400
 MRF19030LR3**

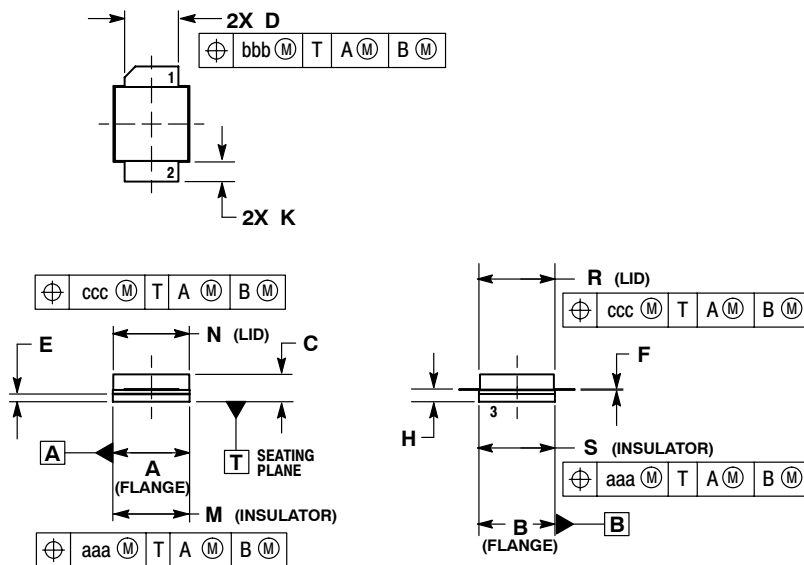

- NOTES:
1. CONTROLLING DIMENSION: INCH.
 2. INTERPRET DIMENSIONS AND TOLERANCES PER ASME Y14.5M-1994.
 3. DIMENSION H IS MEASURED 0.030 (0.762) AWAY FROM PACKAGE BODY.

DIM	INCHES		MILLIMETERS	
	MIN	MAX	MIN	MAX
A	.395	.405	10.03	10.29
B	.395	.405	10.03	10.29
C	.125	.163	3.18	4.14
D	.275	.285	6.98	7.24
E	.035	.045	0.89	1.14
F	.004	.006	0.10	0.15
H	.057	.067	1.45	1.70
K	.092	.122	2.34	3.10
M	.395	.405	10.03	10.29
N	.395	.405	10.03	10.29
R	.395	.405	10.03	10.29
S	.395	.405	10.03	10.29
aaa	.005 REF		0.127 REF	
bbb	.010 REF		0.254 REF	
ccc	.015 REF		0.38 REF	

- STYLE 1:
 PIN 1. DRAIN
 2. GATE
 3. SOURCE

**CASE 465F-04
 ISSUE E
 NI-400S
 MRF19030LSR3**

How to Reach Us:

Home Page:

www.freescale.com

E-mail:

support@freescale.com

USA/Europe or Locations Not Listed:

Freescale Semiconductor
Technical Information Center, CH370
1300 N. Alma School Road
Chandler, Arizona 85224
+1-800-521-6274 or +1-480-768-2130
support@freescale.com

Europe, Middle East, and Africa:

Freescale Halbleiter Deutschland GmbH
Technical Information Center
Schatzbogen 7
81829 Muenchen, Germany
+44 1296 380 456 (English)
+46 8 52200080 (English)
+49 89 92103 559 (German)
+33 1 69 35 48 48 (French)
support@freescale.com

Japan:

Freescale Semiconductor Japan Ltd.
Headquarters
ARCO Tower 15F
1-8-1, Shimo-Meguro, Meguro-ku,
Tokyo 153-0064
Japan
0120 191014 or +81 3 5437 9125
support.japan@freescale.com

Asia/Pacific:

Freescale Semiconductor Hong Kong Ltd.
Technical Information Center
2 Dai King Street
Tai Po Industrial Estate
Tai Po, N.T., Hong Kong
+800 2666 8080
support.asia@freescale.com

For Literature Requests Only:

Freescale Semiconductor Literature Distribution Center
P.O. Box 5405
Denver, Colorado 80217
1-800-441-2447 or 303-675-2140
Fax: 303-675-2150
LDCForFreescaleSemiconductor@hibbertgroup.com

Information in this document is provided solely to enable system and software implementers to use Freescale Semiconductor products. There are no express or implied copyright licenses granted hereunder to design or fabricate any integrated circuits or integrated circuits based on the information in this document.

Freescale Semiconductor reserves the right to make changes without further notice to any products herein. Freescale Semiconductor makes no warranty, representation or guarantee regarding the suitability of its products for any particular purpose, nor does Freescale Semiconductor assume any liability arising out of the application or use of any product or circuit, and specifically disclaims any and all liability, including without limitation consequential or incidental damages. "Typical" parameters that may be provided in Freescale Semiconductor data sheets and/or specifications can and do vary in different applications and actual performance may vary over time. All operating parameters, including "Typicals", must be validated for each customer application by customer's technical experts. Freescale Semiconductor does not convey any license under its patent rights nor the rights of others. Freescale Semiconductor products are not designed, intended, or authorized for use as components in systems intended for surgical implant into the body, or other applications intended to support or sustain life, or for any other application in which the failure of the Freescale Semiconductor product could create a situation where personal injury or death may occur. Should Buyer purchase or use Freescale Semiconductor products for any such unintended or unauthorized application, Buyer shall indemnify and hold Freescale Semiconductor and its officers, employees, subsidiaries, affiliates, and distributors harmless against all claims, costs, damages, and expenses, and reasonable attorney fees arising out of, directly or indirectly, any claim of personal injury or death associated with such unintended or unauthorized use, even if such claim alleges that Freescale Semiconductor was negligent regarding the design or manufacture of the part.

Freescale™ and the Freescale logo are trademarks of Freescale Semiconductor, Inc. All other product or service names are the property of their respective owners.

© Freescale Semiconductor, Inc. 2006. All rights reserved.

