



RF Power Field Effect Transistors

N-Channel Enhancement-Mode Lateral MOSFETs

Designed for PCN and PCS base station applications with frequencies from 1000 to 2600 MHz. Suitable for FM, TDMA, CDMA, and multicarrier amplifier applications. To be used in Class A and Class AB for PCN-PCS/cellular radio and wireless local loop.

- Specified Two-Tone Performance @ 2000 MHz, 26 Volts
 - Output Power = 30 Watts PEP
 - Power Gain = 9 dB
 - Efficiency = 30%
 - Intermodulation Distortion = -29 dBc
- Typical Single-Tone Performance at 2000 MHz, 26 Volts
 - Output Power = 30 Watts CW
 - Power Gain = 9.5 dB
 - Efficiency = 45%
- Capable of Handling 10:1 VSWR, @ 26 Vdc, 2000 MHz, 30 Watts CW
Output Power

Features

- Excellent Thermal Stability
- Characterized with Series Equivalent Large-Signal Impedance Parameters
- Low Gold Plating Thickness on Leads. L Suffix Indicates 40μ" Nominal.
- RoHS Compliant
- In Tape and Reel. R1 Suffix = 500 Units per 32 mm, 13 inch Reel.

MRF284LR1
MRF284LSR1

2000 MHz, 30 W, 26 V
LATERAL N-CHANNEL
BROADBAND
RF POWER MOSFETs

CASE 360B-05, STYLE 1
NI-360
MRF284LR1

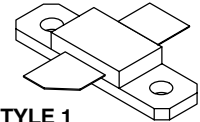

CASE 360C-05, STYLE 1
NI-360S
MRF284LSR1

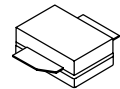

Table 1. Maximum Ratings

Rating	Symbol	Value	Unit
Drain-Source Voltage	V_{DSS}	-0.5, +65	Vdc
Gate-Source Voltage	V_{GS}	±20	Vdc
Total Device Dissipation @ $T_C = 25^\circ\text{C}$ Derate above 25°C	P_D	87.5 0.5	W W/°C
Storage Temperature Range	T_{stg}	-65 to +150	°C
Case Operating Temperature	T_C	150	°C
Operating Junction Temperature	T_J	200	°C

Table 2. Thermal Characteristics

Characteristic	Symbol	Value	Unit
Thermal Resistance, Junction to Case	$R_{\theta JC}$	2.0	°C/W

Table 3. Electrical Characteristics ($T_C = 25^\circ\text{C}$ unless otherwise noted)

Characteristic	Symbol	Min	Typ	Max	Unit
Drain-Source Breakdown Voltage ($V_{GS} = 0, I_D = 10 \mu\text{A dc}$)	$V_{(BR)DSS}$	65	—	—	Vdc
Zero Gate Voltage Drain Current ($V_{DS} = 20 \text{ Vdc}, V_{GS} = 0$)	I_{DSS}	—	—	1.0	$\mu\text{A dc}$
Gate-Source Leakage Current ($V_{GS} = 20 \text{ Vdc}, V_{DS} = 0$)	I_{GSS}	—	—	10	$\mu\text{A dc}$

(continued)

NOTE - CAUTION - MOS devices are susceptible to damage from electrostatic charge. Reasonable precautions in handling and packaging MOS devices should be observed.

Table 3. Electrical Characteristics ($T_C = 25^\circ\text{C}$ unless otherwise noted) (continued)

Characteristic	Symbol	Min	Typ	Max	Unit
On Characteristics					
Gate Threshold Voltage ($V_{DS} = 10\text{ Vdc}$, $I_D = 150\ \mu\text{Adc}$)	$V_{GS(th)}$	2.0	3.0	4.0	Vdc
Gate Quiescent Voltage ($V_{DS} = 26\text{ Vdc}$, $I_D = 200\ \text{mAdc}$)	$V_{GS(q)}$	3.0	4.0	5.0	Vdc
Drain-Source On-Voltage ($V_{GS} = 10\text{ Vdc}$, $I_D = 1.0\ \text{Adc}$)	$V_{DS(on)}$	—	0.3	0.6	Vdc
Forward Transconductance ($V_{DS} = 10\text{ Vdc}$, $I_D = 1.0\ \text{Adc}$)	g_{fs}	—	1.5	—	S
Dynamic Characteristics					
Input Capacitance ($V_{DS} = 26\text{ Vdc}$, $V_{GS} = 0$, $f = 1.0\ \text{MHz}$)	C_{iss}	—	43	—	pF
Output Capacitance ($V_{DS} = 26\text{ Vdc}$, $V_{GS} = 0$, $f = 1.0\ \text{MHz}$)	C_{oss}	—	23	—	pF
Reverse Transfer Capacitance ($V_{DS} = 26\text{ Vdc}$, $V_{GS} = 0$, $f = 1.0\ \text{MHz}$)	C_{rss}	—	1.4	—	pF
Functional Tests (in Freescale Test Fixture, 50 ohm system)					
Common-Source Power Gain ($V_{DD} = 26\text{ Vdc}$, $P_{out} = 30\ \text{W}$, $I_{DQ} = 200\ \text{mA}$, $f_1 = 2000.0\ \text{MHz}$, $f_2 = 2000.1\ \text{MHz}$)	G_{ps}	9	10.5	—	dB
Drain Efficiency ($V_{DD} = 26\text{ Vdc}$, $P_{out} = 30\ \text{W}$, $I_{DQ} = 200\ \text{mA}$, $f_1 = 2000.0\ \text{MHz}$, $f_2 = 2000.1\ \text{MHz}$)	η	30	35	—	%
Intermodulation Distortion ($V_{DD} = 26\text{ Vdc}$, $P_{out} = 30\ \text{W}$, $I_{DQ} = 200\ \text{mA}$, $f_1 = 2000.0\ \text{MHz}$, $f_2 = 2000.1\ \text{MHz}$)	IMD	—	-32	-29	dBc
Input Return Loss ($V_{DD} = 26\text{ Vdc}$, $P_{out} = 30\ \text{W}$, $I_{DQ} = 200\ \text{mA}$, $f_1 = 2000.0\ \text{MHz}$, $f_2 = 2000.1\ \text{MHz}$)	IRL	—	-15	-9	dB
Common-Source Amplifier Power Gain ($V_{DD} = 26\text{ Vdc}$, $P_{out} = 30\ \text{W PEP}$, $I_{DQ} = 200\ \text{mA}$, $f_1 = 1930.0\ \text{MHz}$, $f_2 = 1930.1\ \text{MHz}$)	G_{ps}	9	10.4	—	dB
Drain Efficiency ($V_{DD} = 26\text{ Vdc}$, $P_{out} = 30\ \text{W PEP}$, $I_{DQ} = 200\ \text{mA}$, $f_1 = 1930.0\ \text{MHz}$, $f_2 = 1930.1\ \text{MHz}$)	η	—	35	—	%
Intermodulation Distortion ($V_{DD} = 26\text{ Vdc}$, $P_{out} = 30\ \text{W PEP}$, $I_{DQ} = 200\ \text{mA}$, $f_1 = 1930.0\ \text{MHz}$, $f_2 = 1930.1\ \text{MHz}$)	IMD	—	-34	—	dBc
Input Return Loss ($V_{DD} = 26\text{ Vdc}$, $P_{out} = 30\ \text{W PEP}$, $I_{DQ} = 200\ \text{mA}$, $f_1 = 1930.0\ \text{MHz}$, $f_2 = 1930.1\ \text{MHz}$)	IRL	—	-15	-9	dB
Common-Source Amplifier Power Gain ($V_{DD} = 26\text{ Vdc}$, $P_{out} = 30\ \text{W CW}$, $I_{DQ} = 200\ \text{mA}$, $f_1 = 2000.0\ \text{MHz}$)	G_{ps}	8.5	9.5	—	dB
Drain Efficiency ($V_{DD} = 26\text{ Vdc}$, $P_{out} = 30\ \text{W CW}$, $I_{DQ} = 200\ \text{mA}$, $f_1 = 2000.0\ \text{MHz}$)	η	35	45	—	%

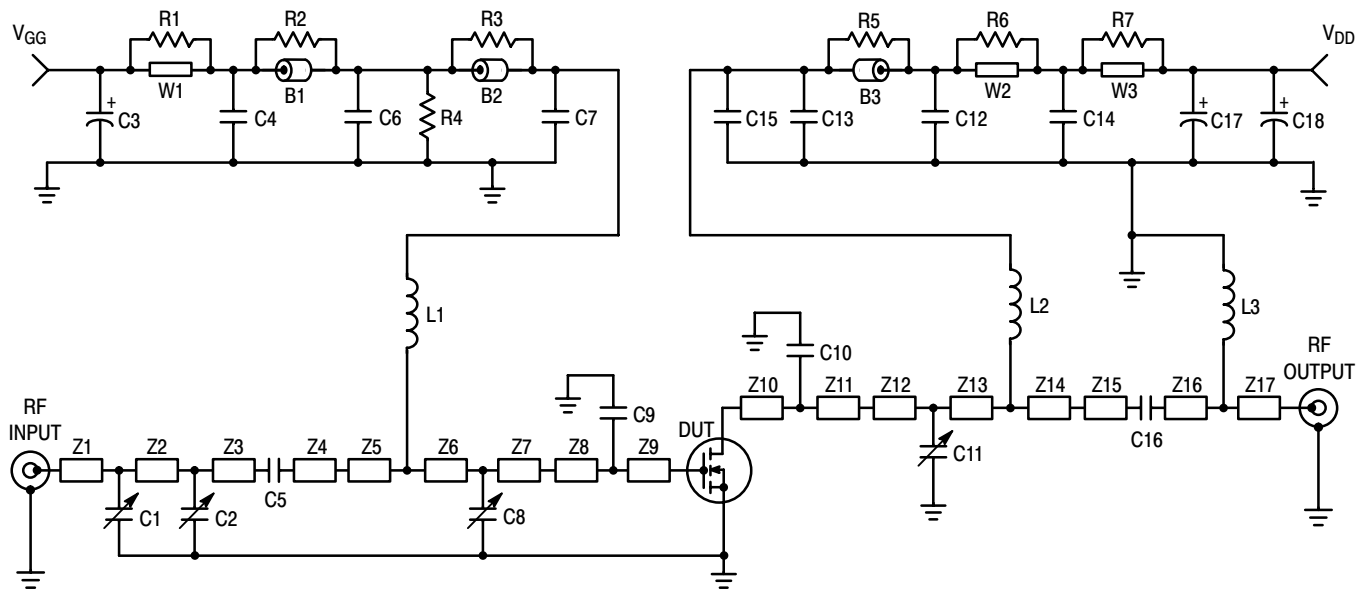

- | | | | |
|-----|----------------------------|-----|----------------------------------------------------|
| Z1 | 0.530" x 0.080" Microstrip | Z11 | 0.155" x 0.515" Microstrip |
| Z2 | 0.255" x 0.080" Microstrip | Z12 | 0.120" x 0.325" Microstrip |
| Z3 | 0.600" x 0.080" Microstrip | Z13 | 0.150" x 0.325" Microstrip |
| Z4 | 0.525" x 0.080" Microstrip | Z14 | 0.010" x 0.325" Microstrip |
| Z5 | 0.015" x 0.325" Microstrip | Z15 | 0.505" x 0.080" Microstrip |
| Z6 | 0.085" x 0.325" Microstrip | Z16 | 0.865" x 0.080" Microstrip |
| Z7 | 0.165" x 0.325" Microstrip | Z17 | 0.525" x 0.080" Microstrip |
| Z8 | 0.110" x 0.515" Microstrip | PCB | Arlon GX0300-55-22, 0.030",
$\epsilon_r = 2.55$ |
| Z9 | 0.095" x 0.515" Microstrip | | |
| Z10 | 0.050" x 0.515" Microstrip | | |

Figure 1. 1930-2000 MHz Broadband Test Circuit Schematic

Table 4. 1930-2000 MHz Broadband Test Circuit Component Designations and Values

Designators	Description
B1 - B3	Ferrite Beads, Round, Ferroxcube #56-590-65-3B
C1, C2, C8	0.8-8.0 pF Gigatrim Variable Capacitors, Johanson #27291SL
C3, C17	22 μ F, 35 V Tantalum Surface Mount Chip Capacitors, Kemet #T491X226K035AS4394
C4, C14	0.1 μ F Chip Capacitors, Kemet #CDR33BX104AKWS
C5	220 pF Chip Capacitor, ATC #100B221KP500X
C6, C12	1000 pF Chip Capacitors, ATC #100B102JCA50X
C7, C13	5.1 pF Chip Capacitors, ATC #100B5R1CCA500X
C9	1.2 pF Chip Capacitor, ATC #100B1R2CCA500X
C10	2.7 pF Chip Capacitor, ATC #100B2R7CCA500X
C11	0.6-4.5 pF Gigatrim Variable Capacitors, Johanson #27271SL
C15, C16	200 pF Chip Capacitors, ATC #100B201KP500X
C18	10 μ F, 35 V Tantalum Surface Mount Chip Capacitor, Kemet #T495X106K035AS4394
L1, L2	4 Turns, #24 AWG, 0.120" OD, 0.140" Long, (12.5 nH), Coilcraft #A04T-5
L3	2 Turns, #24 AWG, 0.120" OD, 0.140" Long, (5.0 nH), Coilcraft #A02T-5
R1, R2, R3, R5, R6, R7	12 Ω , 1/4 W Chip Resistors, 0.08" x 0.13", Garrett Instruments #RM73B2B120JT
R4	560 k Ω , 1/4 W Chip Resistor, 0.08" x 0.13"
W1, W2, W3	Solid Copper Buss Wire, 16 AWG
WS1, WS2	Beryllium Copper Wear Blocks 0.005" x 0.250" x 0.250"

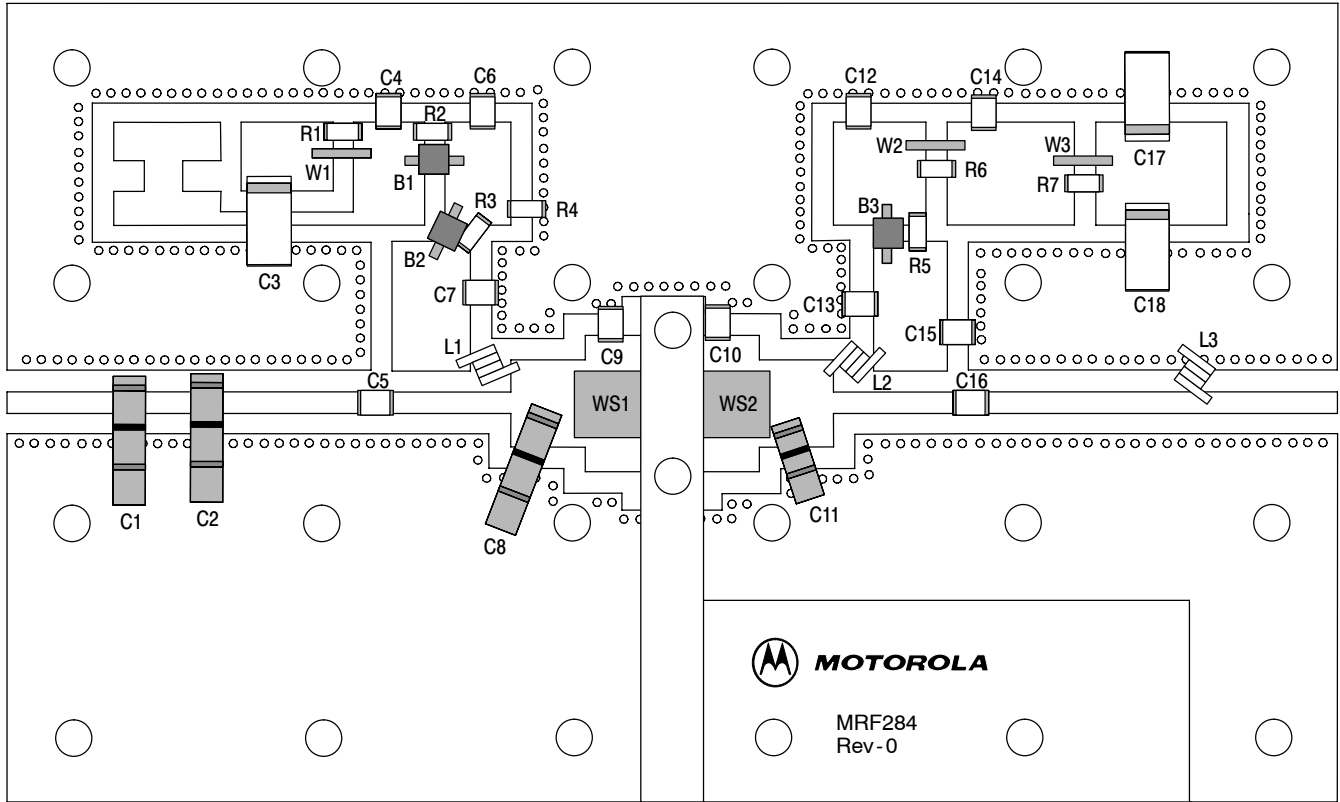

Freescale has begun the transition of marking Printed Circuit Boards (PCBs) with the Freescale Semiconductor signature/logo. PCBs may have either Motorola or Freescale markings during the transition period. These changes will have no impact on form, fit or function of the current product.

Figure 2. 1930-2000 MHz Broadband Test Circuit Component Layout

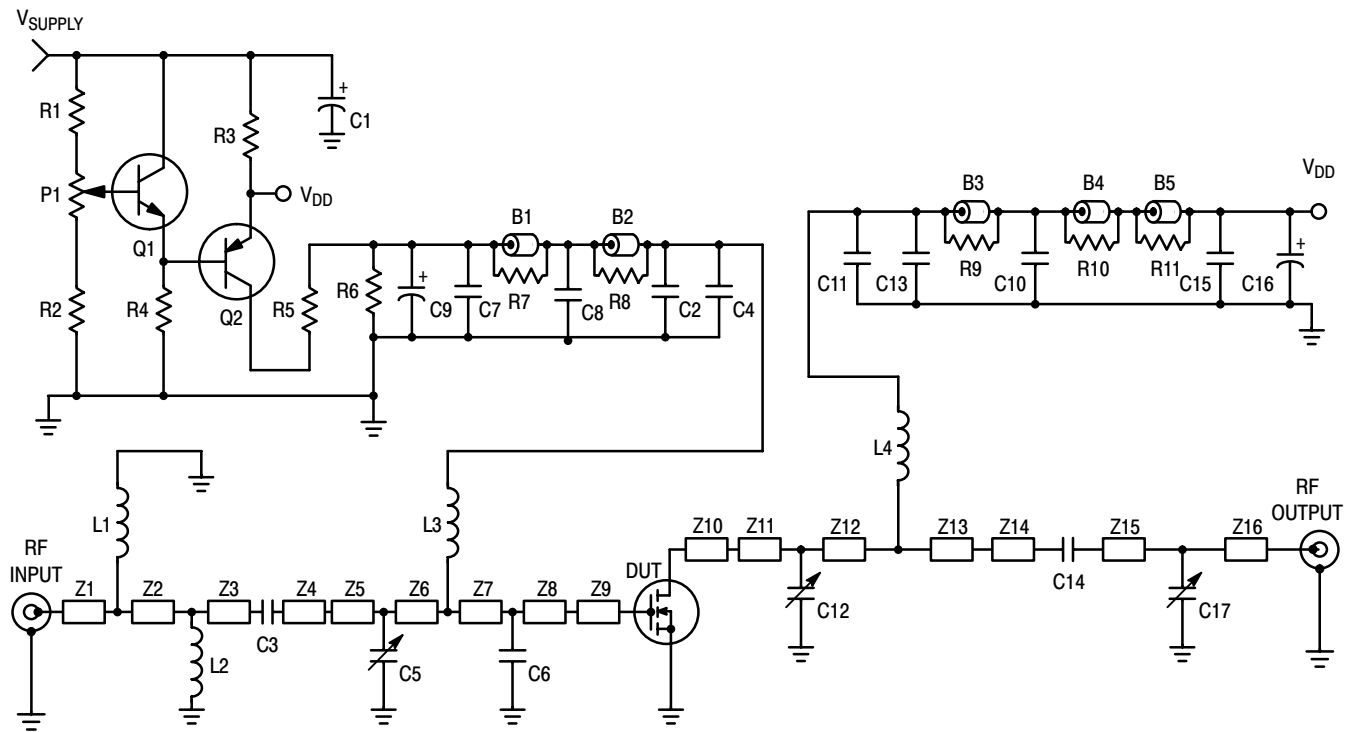

Z1	0.363" x 0.080" Microstrip	Z10	0.210" x 0.515" Microstrip
Z2	0.080" x 0.080" Microstrip	Z11	0.235" x 0.325" Microstrip
Z3	0.916" x 0.080" Microstrip	Z12	0.02" x 0.325" Microstrip
Z4	0.517" x 0.080" Microstrip	Z13	0.02" x 0.325" Microstrip
Z5	0.050" x 0.325" Microstrip	Z14	0.510" x 0.080" Microstrip
Z6	0.050" x 0.325" Microstrip	Z15	0.990" x 0.080" Microstrip
Z7	0.071" x 0.325" Microstrip	Z16	0.390" x 0.080" Microstrip
Z8	0.125" x 0.325" Microstrip	PCB	Arlon GX0300-55-22, 0.030", $\epsilon_r = 2.55$
Z9	0.210" x 0.515" Microstrip		

Figure 3. 2000 MHz Class A Test Circuit Schematic

Table 5. 2000 MHz Class A Test Circuit Component Designations and Values

Designators	Description
B1 - B5	Ferrite Beads, Round, Ferroxcube # 56-590-65-3B
C1, C9, C16	100 μ F, 50 V Electrolytic Capacitors, Mallory #SME50VB101M12X25L
C2, C13	51 pF Chip Capacitors, ATC #100B510JCA500x
C3, C14	10 pF Chip Capacitors, ATC #100B100JCA500X
C4, C11	12 pF Chip Capacitors, ATC #100B120JCA500X
C5	0.8 - 8.0 pF Variable Capacitor, Johansen Gigatrim #27291SL
C6	4.7 pF Chip Capacitor, ATC #100B4R7CCA500X
C7, C15	91 pF Chip Capacitors, ATC #100B910KP500X
C8	1000 pF Chip Capacitor, ATC #100B102JCA50X
C10	0.1 μ F Chip Capacitor, Kemet #CDR33BX104AKWS
C12, C17	0.6 - 4.5 pF Variable Capacitors, Johansen Gigatrim #27271SL
L1	4 Turns, #27 AWG, 0.087" OD, 0.050" ID, 0.069" Long, 10 nH
L2	5 Turns, #24 AWG, 0.083" OD, 0.040" ID, 0.128" Long, 12.5 nH
L3, L4	9 Turns, #26 AWG, 0.080" OD, 0.046" ID, 0.170" Long, 30.8 nH
P1	1000 Ω Potentiometer, 1/2 W, 10 Turns, Bourns
Q1	Transistor, NPN, #MJD31, Case 369A - 10
Q2	Transistor, PNP, #MJD32, Case 369A - 10
R1	360 Ω , Fixed Film Chip Resistor, 0.08" x 0.13", Garrett Instruments #RM73B2B361JT
R2	2 x 12 k Ω , Fixed Film Chip Resistor, 0.08" x 0.13", Garrett Instruments #RM73B2B122JT
R3	1 Ω , Wirewound, 5 W, 3% Resistor, Dale # RE60G1R00
R4	4 x 6.8 k Ω , Fixed Film Chip Resistor, 0.08" x 0.13", Garrett Instruments #RM73B2B682JT
R5	2 x 1500 Ω , Fixed Film Chip Resistor, 0.08" x 0.13", Garrett Instruments #RM73B2B152JT
R6	270 Ω , Fixed Film Chip Resistor, 0.08" x 0.13", Garrett Instruments #RM73B2B271JT
R7 - R11	12 Ω , Fixed Film Chip Resistors, 0.08" x 0.13", Garrett Instruments #RM73B2B120JT

TYPICAL CHARACTERISTICS

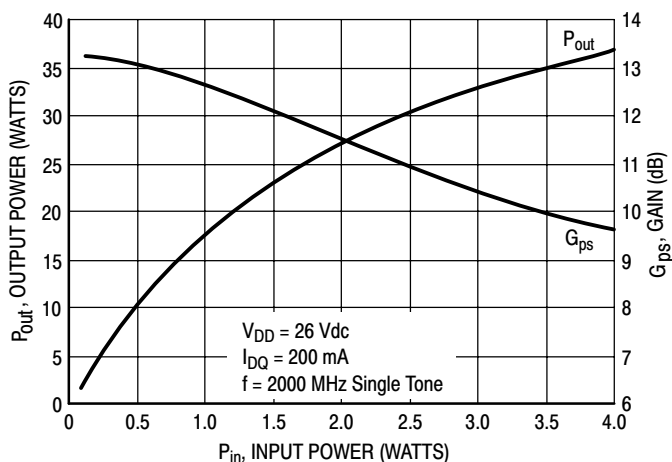

Figure 4. Output Power & Power Gain versus Input Power

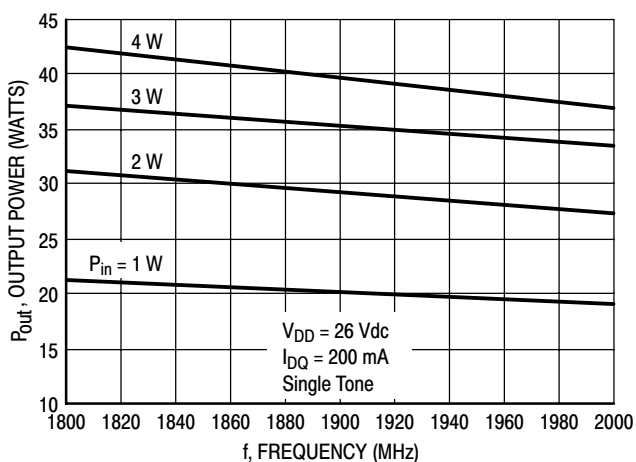

Figure 5. Output Power versus Frequency

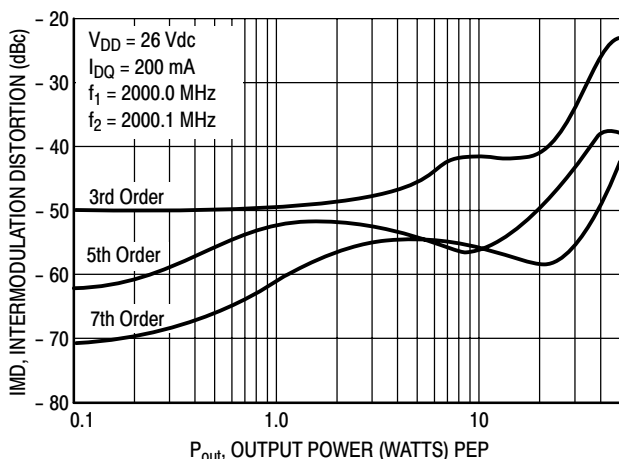

Figure 6. Intermodulation Distortion Products versus Output Power

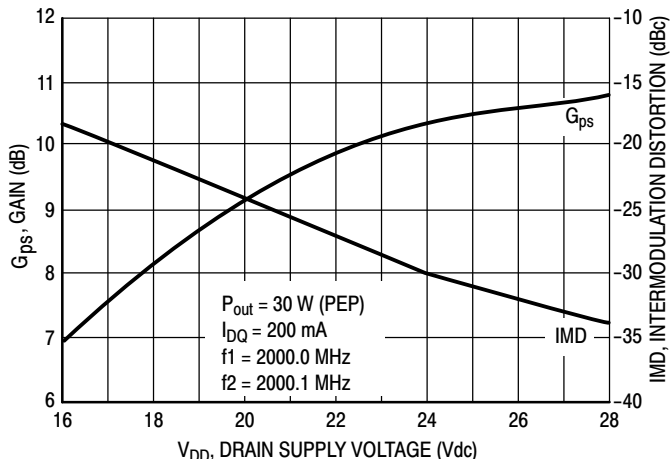

Figure 7. Power Gain and Intermodulation Distortion versus Supply Voltage

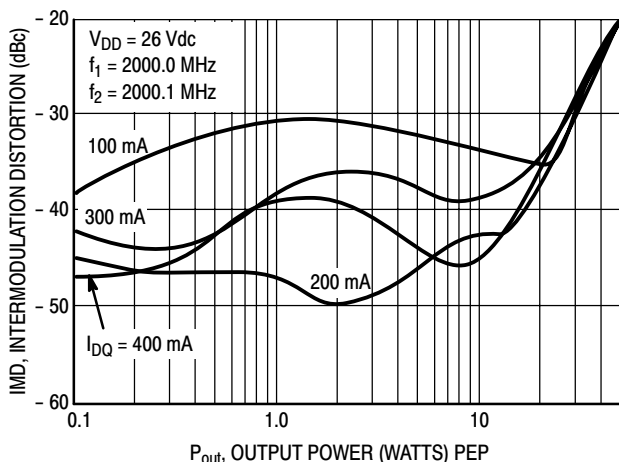

Figure 8. Intermodulation Distortion versus Output Power

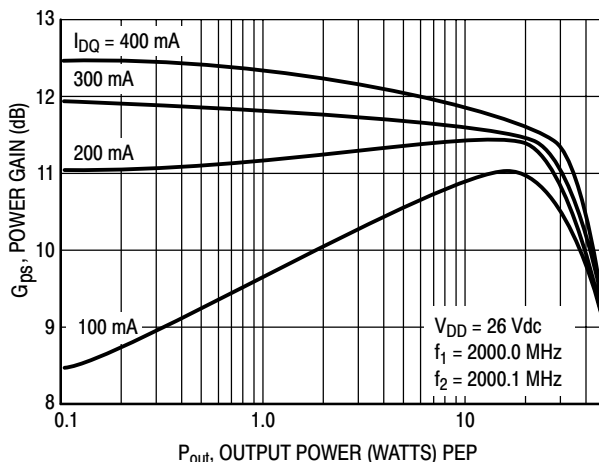

Figure 9. Power Gain versus Output Power

TYPICAL CHARACTERISTICS

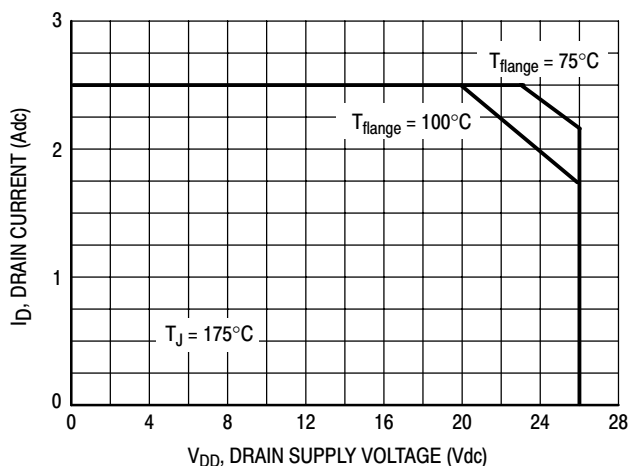

Figure 10. DC Safe Operating Area

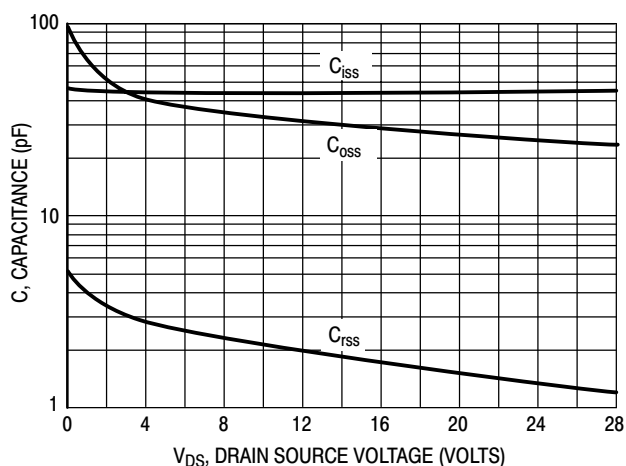

Figure 11. Capacitance versus Drain Source Voltage

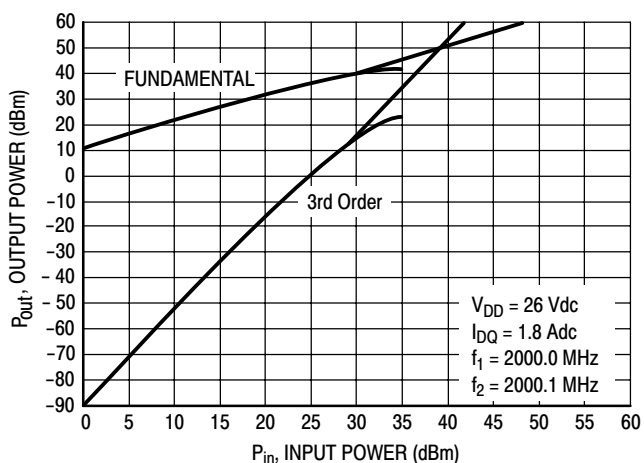

Figure 12. Class A Third Order Intercept Point

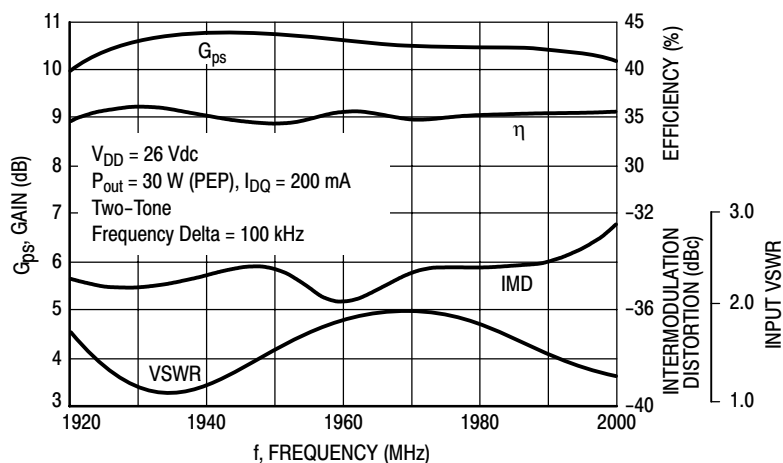
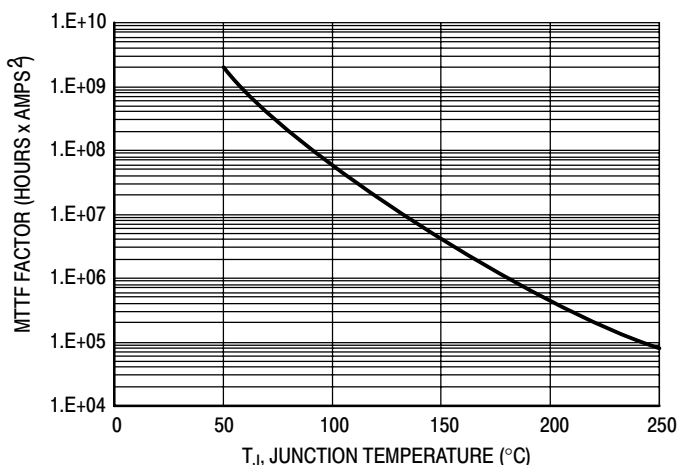
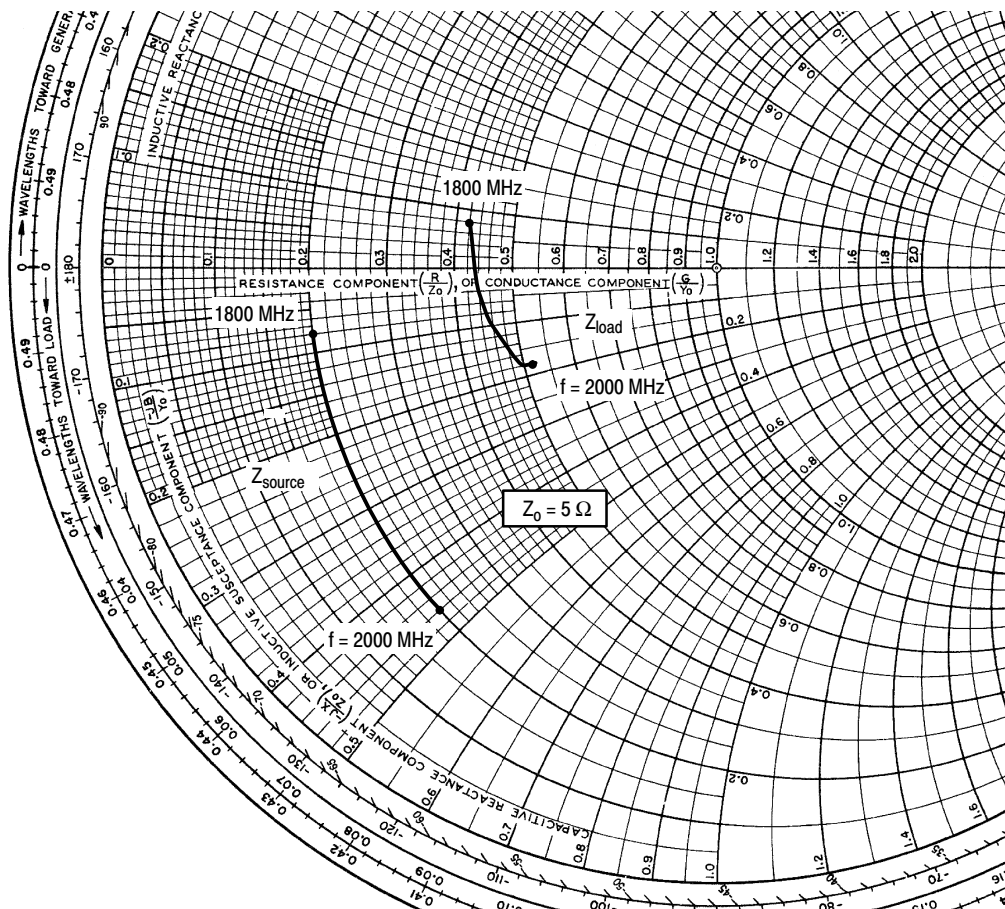

Figure 13. 1920-2000 MHz Broadband Circuit Performance



This graph displays calculated MTTF in hours x ampere² drain current. Life tests at elevated temperature have correlated to better than $\pm 10\%$ of the theoretical prediction for metal failure. Divide MTTF factor by I_D^2 for MTTF in a particular application.

Figure 14. MTTF Factor versus Junction Temperature



$V_{CC} = 26\text{ V}$, $I_{DQ} = 200\text{ mA}$, $P_{out} = 15\text{ W Avg.}$

f MHz	Z_{source} Ω	Z_{load} Ω
1800	$1.0 - j0.4$	$2.1 + j0.4$
1860	$1.0 - j0.8$	$2.2 - j0.2$
1900	$1.0 - j1.1$	$2.3 - j0.5$
1960	$1.0 - j1.4$	$2.5 - j0.9$
2000	$1.0 - j2.3$	$2.6 - j0.92$

Z_{source} = Test circuit impedance as measured from gate to ground.

Z_{load} = Test circuit impedance as measured from drain to ground.

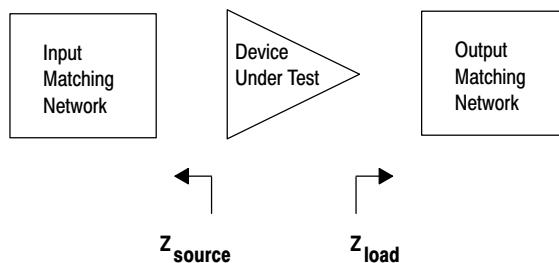
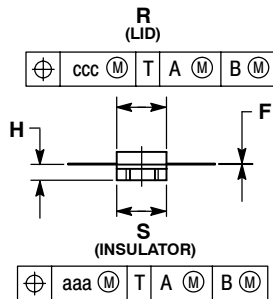
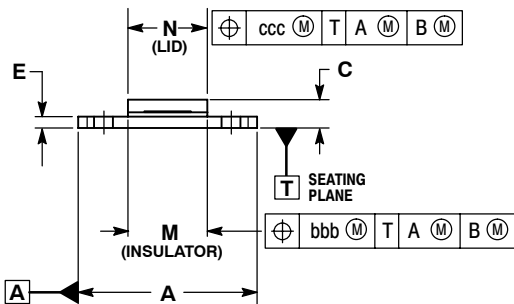
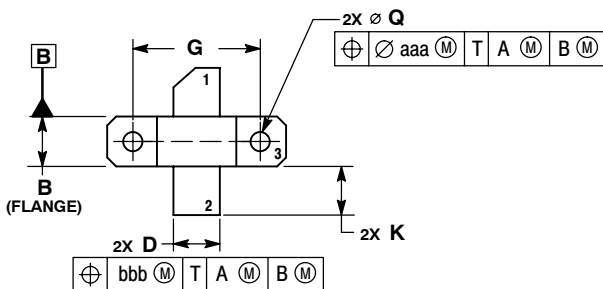

Figure 15. Series Equivalent Source and Load Impedance

NOTES

PACKAGE DIMENSIONS



**CASE 360B-05
ISSUE G
NI-360
MRF284LR1**

- NOTES:
1. INTERPRET DIMENSIONS AND TOLERANCES PER ASME Y14.5M-1994.
 2. CONTROLLING DIMENSION: INCH.
 3. DIMENSION H IS MEASURED 0.030 (0.762) AWAY FROM PACKAGE BODY.

DIM	INCHES		MILLIMETERS	
	MIN	MAX	MIN	MAX
A	0.795	0.805	20.19	20.45
B	0.225	0.235	5.72	5.97
C	0.125	0.175	3.18	4.45
D	0.210	0.220	5.33	5.59
E	0.055	0.065	1.40	1.65
F	0.004	0.006	0.10	0.15
G	0.562 BSC		14.28 BSC	
H	0.077	0.087	1.96	2.21
K	0.220	0.250	5.59	6.35
M	0.355	0.365	9.02	9.27
N	0.357	0.363	9.07	9.22
Q	0.125	0.135	3.18	3.43
R	0.227	0.233	5.77	5.92
S	0.225	0.235	5.72	5.97
aaa	0.005 REF		0.13 REF	
bbb	0.010 REF		0.25 REF	
ccc	0.015 REF		0.38 REF	

- STYLE 1:
PIN 1. DRAIN
2. GATE
3. SOURCE

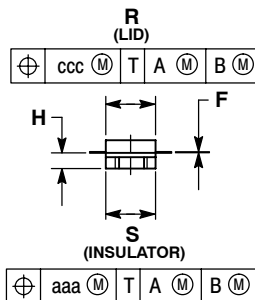
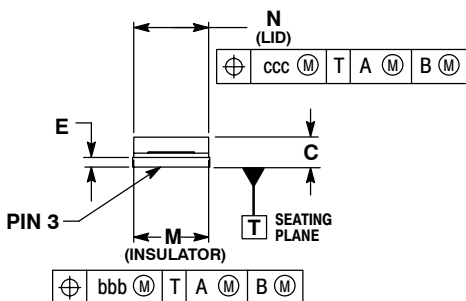
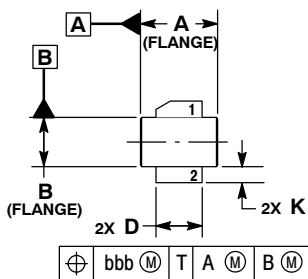

**CASE 360C-05
ISSUE E
NI-360S
MRF284LSR1**

- NOTES:
1. INTERPRET DIMENSIONS AND TOLERANCES PER ASME Y14.5M-1994.
 2. CONTROLLING DIMENSION: INCH.
 3. DIMENSION H IS MEASURED 0.030 (0.762) AWAY FROM PACKAGE BODY.

DIM	INCHES		MILLIMETERS	
	MIN	MAX	MIN	MAX
A	0.375	0.385	9.53	9.78
B	0.225	0.235	5.72	5.97
C	0.105	0.155	2.67	3.94
D	0.210	0.220	5.33	5.59
E	0.035	0.045	0.89	1.14
F	0.004	0.006	0.10	0.15
H	0.057	0.067	1.45	1.70
K	0.085	0.115	2.16	2.92
M	0.355	0.365	9.02	9.27
N	0.357	0.363	9.07	9.22
R	0.227	0.23	5.77	5.92
S	0.225	0.235	5.72	5.97
aaa	0.005 REF		0.13 REF	
bbb	0.010 REF		0.25 REF	
ccc	0.015 REF		0.38 REF	

- STYLE 1:
PIN 1. DRAIN
2. GATE
3. SOURCE

MRF284LR1 MRF284LSR1

How to Reach Us:

Home Page:

www.freescale.com

E-mail:

support@freescale.com

USA/Europe or Locations Not Listed:

Freescale Semiconductor
Technical Information Center, CH370
1300 N. Alma School Road
Chandler, Arizona 85224
+1-800-521-6274 or +1-480-768-2130
support@freescale.com

Europe, Middle East, and Africa:

Freescale Halbleiter Deutschland GmbH
Technical Information Center
Schatzbogen 7
81829 Muenchen, Germany
+44 1296 380 456 (English)
+46 8 52200080 (English)
+49 89 92103 559 (German)
+33 1 69 35 48 48 (French)
support@freescale.com

Japan:

Freescale Semiconductor Japan Ltd.
Headquarters
ARCO Tower 15F
1-8-1, Shimo-Meguro, Meguro-ku,
Tokyo 153-0064
Japan
0120 191014 or +81 3 5437 9125
support.japan@freescale.com

Asia/Pacific:

Freescale Semiconductor Hong Kong Ltd.
Technical Information Center
2 Dai King Street
Tai Po Industrial Estate
Tai Po, N.T., Hong Kong
+800 2666 8080
support.asia@freescale.com

For Literature Requests Only:

Freescale Semiconductor Literature Distribution Center
P.O. Box 5405
Denver, Colorado 80217
1-800-441-2447 or 303-675-2140
Fax: 303-675-2150
LDCForFreescaleSemiconductor@hibbertgroup.com

Information in this document is provided solely to enable system and software implementers to use Freescale Semiconductor products. There are no express or implied copyright licenses granted hereunder to design or fabricate any integrated circuits or integrated circuits based on the information in this document.

Freescale Semiconductor reserves the right to make changes without further notice to any products herein. Freescale Semiconductor makes no warranty, representation or guarantee regarding the suitability of its products for any particular purpose, nor does Freescale Semiconductor assume any liability arising out of the application or use of any product or circuit, and specifically disclaims any and all liability, including without limitation consequential or incidental damages. "Typical" parameters that may be provided in Freescale Semiconductor data sheets and/or specifications can and do vary in different applications and actual performance may vary over time. All operating parameters, including "Typicals", must be validated for each customer application by customer's technical experts. Freescale Semiconductor does not convey any license under its patent rights nor the rights of others. Freescale Semiconductor products are not designed, intended, or authorized for use as components in systems intended for surgical implant into the body, or other applications intended to support or sustain life, or for any other application in which the failure of the Freescale Semiconductor product could create a situation where personal injury or death may occur. Should Buyer purchase or use Freescale Semiconductor products for any such unintended or unauthorized application, Buyer shall indemnify and hold Freescale Semiconductor and its officers, employees, subsidiaries, affiliates, and distributors harmless against all claims, costs, damages, and expenses, and reasonable attorney fees arising out of, directly or indirectly, any claim of personal injury or death associated with such unintended or unauthorized use, even if such claim alleges that Freescale Semiconductor was negligent regarding the design or manufacture of the part.

Freescale™ and the Freescale logo are trademarks of Freescale Semiconductor, Inc. All other product or service names are the property of their respective owners.
© Freescale Semiconductor, Inc. 2006. All rights reserved.

