

256K(32K x 8) Static RAM

Features

- **Single 3.3V power supply**
- **Ideal for low-voltage cache memory applications**
- **High speed**
— 10/12/15 ns
- **Low active power**
— 216 mW (max.)
- **Low-power alpha immune 6T cell**
- **Plastic SOJ and TSOP packaging**

Functional Description^[1]

The CY7C1399B is a high-performance 3.3V CMOS Static RAM organized as 32,768 words by 8 bits. Easy memory expansion is provided by an active LOW Chip Enable (CE) and

active LOW Output Enable (\overline{OE}) and three-state drivers. The device has an automatic power-down feature, reducing the power consumption by more than 95% when deselected.

An active LOW Write Enable signal (\overline{WE}) controls the writing/reading operation of the memory. When CE and WE inputs are both LOW, data on the eight data input/output pins (I/O₀ through I/O₇) is written into the memory location addressed by the address present on the address pins (A₀ through A₁₄). Reading the device is accomplished by selecting the device and enabling the outputs, CE and OE active LOW, while WE remains inactive or HIGH. Under these conditions, the contents of the location addressed by the information on address pins is present on the eight data input/output pins.

The input/output pins remain in a high-impedance state unless the chip is selected, outputs are enabled, and Write Enable (\overline{WE}) is HIGH. The CY7C1399B is available in 28-pin standard 300-mil-wide SOJ and TSOP Type I packages.

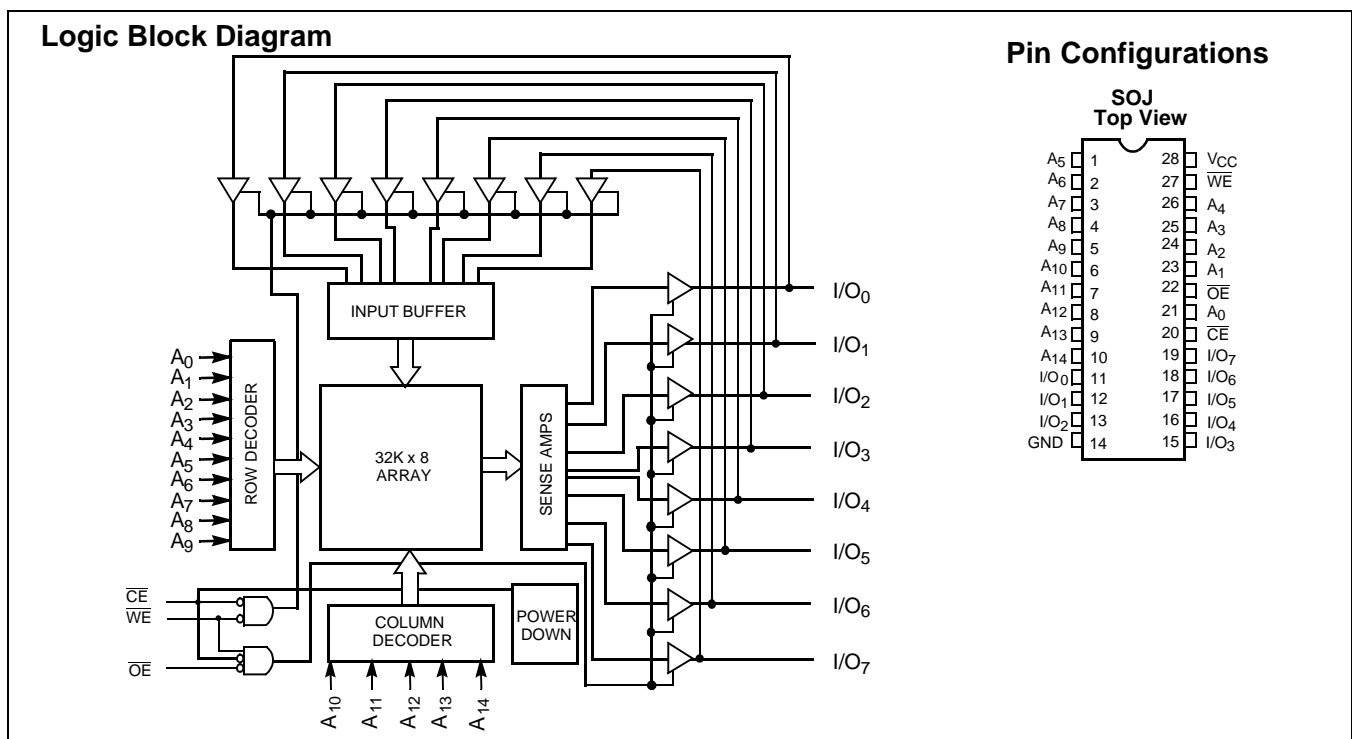

Selection Guide

	1399B-10	1399B-12	1399B-15	1399B-20	Unit
Maximum Access Time	10	12	15	20	ns
Maximum Operating Current	60	55	50	45	mA
Maximum CMOS Standby Current	500	500	500	500	μA
	L	50	50	50	μA

Note:

1. For guidelines on SRAM system design, please refer to the 'System Design Guidelines' Cypress application note, available on the internet at www.cypress.com.

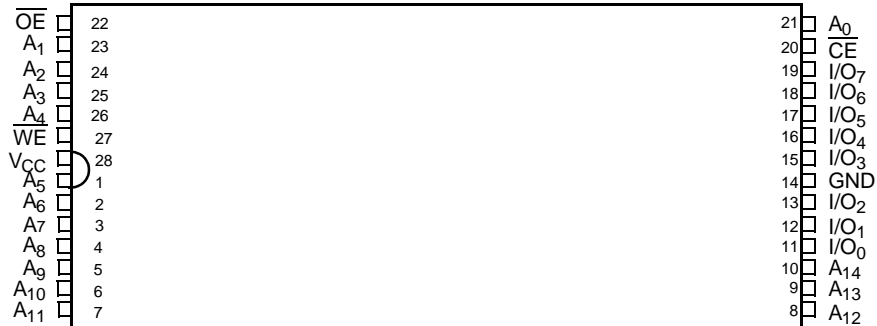
Pin Configuration
**TSOP
Top View**

Maximum Ratings

(Above which the useful life may be impaired. For user guidelines, not tested.)

Storage Temperature -65°C to +150°C
 Ambient Temperature with Power Applied -55°C to +125°C
 Supply Voltage on V_{CC} to Relative GND^[2] -0.5V to +4.6V
 DC Voltage Applied to Outputs in High Z State^[2] -0.5V to V_{CC} + 0.5V
 DC Input Voltage^[2] -0.5V to V_{CC} + 0.5V

Output Current into Outputs (LOW) 20 mA
 Static Discharge Voltage >2001V (per MIL-STD-883, Method 3015)
 Latch-Up Current >200 mA

Operating Range

Range	Ambient Temperature	V _{CC}
Commercial	0°C to +70°C	3.3V ±300 mV
Industrial	-40°C to +85°C	3.3V ±300 mV

Electrical Characteristics Over the Operating Range^[1]

Parameter	Description	Test Conditions	7C1399B-10		7C1399B-12		Unit
			Min.	Max.	Min.	Max.	
V _{OH}	Output HIGH Voltage	V _{CC} = Min., I _{OH} = -2.0 mA	2.4		2.4		V
V _{OL}	Output LOW Voltage	V _{CC} = Min., I _{OL} = 4.0 mA		0.4		0.4	V
V _{IH}	Input HIGH Voltage		2.2	V _{CC} + 0.3V	2.2	V _{CC} + 0.3V	V
V _{IL}	Input LOW Voltage ^[2]		-0.3	0.8	-0.3	0.8	V
I _{IX}	Input Load Current		-1	+1	-1	+1	μA
I _{OZ}	Output Leakage Current	GND ≤ V _I ≤ V _{CC} , Output Disabled	-5	+5	-5	+5	μA
I _{OS}	Output Short Circuit Current ^[3]	V _{CC} = Max., V _{OUT} = GND		-300		-300	mA
I _{CC}	V _{CC} Operating Supply Current	V _{CC} = Max., I _{OUT} = 0 mA, f = f _{MAX} = 1/t _{RC}		60		55	mA
I _{SB1}	Automatic CE Power-Down Current — TTL Inputs	Max. V _{CC} , $\overline{CE} \geq V_{IH}$, V _{IN} ≥ V _{IH} , or V _{IN} ≤ V _{IL} , f = f _{MAX}		5		5	mA
			L	4		4	mA
I _{SB2}	Automatic CE Power-Down Current — CMOS Inputs ^[4]	Max. V _{CC} , $\overline{CE} \geq V_{CC} - 0.3V$, V _{IN} ≥ V _{CC} - 0.3V, or V _{IN} ≤ 0.3V, WE ≥ V _{CC} - 0.3V or WE ≤ 0.3V, f = f _{MAX}		500		500	μA
			L	50		50	μA

Notes:

- Minimum voltage is equal to -2.0V for pulse durations of less than 20 ns.
- Not more than one output should be shorted at one time. Duration of the short circuit should not exceed 30 seconds.
- Device draws low standby current regardless of switching on the addresses.

Electrical Characteristics Over the Operating Range (continued)

Parameter	Description	Test Conditions	1399B-15		1399B-20		Unit
			Min.	Max.	Min.	Max.	
V _{OH}	Output HIGH Voltage	V _{CC} = Min., I _{OH} = -2.0 mA	2.4		2.4		V
V _{OL}	Output LOW Voltage	V _{CC} = Min., I _{OL} = 4.0 mA		0.4		0.4	V
V _{IH}	Input HIGH Voltage		2.2	V _{CC} + 0.3V	2.2	V _{CC} + 0.3V	V
V _{IL}	Input LOW Voltage		-0.3	0.8	-0.3	0.8	V
I _{IX}	Input Load Current		-1	+1	-1	+1	μA
I _{OZ}	Output Leakage Current	GND ≤ V _I ≤ V _{CC} , Output Disabled	-5	+5	-5	+5	μA
I _{OS}	Output Short Circuit Current ^[3]	V _{CC} = Max., V _{OUT} = GND		-300		-300	mA
I _{CC}	V _{CC} Operating Supply Current	V _{CC} = Max., I _{OUT} = 0 mA, f = f _{MAX} = 1/t _{RC}		50		45	mA
I _{SB1}	Automatic CE Power-Down Current — TTL Inputs	Max. V _{CC} , $\overline{CE} \geq V_{IH}$, V _{IN} ≥ V _{IH} , or V _{IN} ≤ V _{IL} , f = f _{MAX}		5		5	mA
			L	4		4	mA
I _{SB2}	Automatic CE Power-Down Current — CMOS Inputs ^[4]	Max. V _{CC} , $\overline{CE} \geq V_{CC} - 0.3V$, V _{IN} ≥ V _{CC} - 0.3V, or V _{IN} ≤ 0.3V, WE ≥ V _{CC} - 0.3V or WE ≤ 0.3V, f = f _{MAX}		500		500	μA
			L	50		50	μA

Capacitance^[5]

Parameter	Description	Test Conditions	Max.	Unit
C _{IN} : Addresses	Input Capacitance	T _A = 25°C, f = 1 MHz, V _{CC} = 3.3V	5	pF
C _{IN} : Controls			6	pF
C _{OUT}	Output Capacitance		6	pF

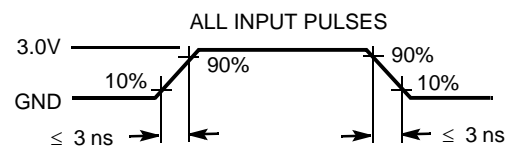
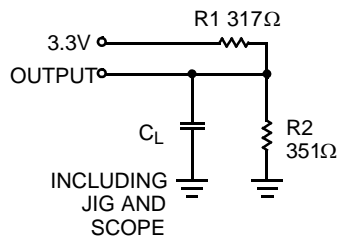
AC Test Loads and Waveforms

Equivalent to: THÉVENIN EQUIVALENT

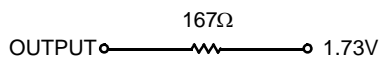
Note:

5. Tested initially and after any design or process changes that may affect these parameters.

Switching Characteristics Over the Operating Range^[6]

Parameter	Description	1399B-10		1399B-12		Unit
		Min.	Max.	Min.	Max.	
Read Cycle						
t_{RC}	Read Cycle Time	10		12		ns
t_{AA}	Address to Data Valid		10		12	ns
t_{OHA}	Data Hold from Address Change	3		3		ns
t_{ACE}	\overline{CE} LOW to Data Valid		10		12	ns
t_{DOE}	\overline{OE} LOW to Data Valid		5		5	ns
t_{LZOE}	\overline{OE} LOW to Low Z ^[7]	0		0		ns
t_{HZOE}	\overline{OE} HIGH to High Z ^[7, 8]		5		5	ns
t_{LZCE}	\overline{CE} LOW to Low Z ^[7]	3		3		ns
t_{HZCE}	\overline{CE} HIGH to High Z ^[7, 8]		5		6	ns
t_{PU}	\overline{CE} LOW to Power-Up	0		0		ns
t_{PD}	\overline{CE} HIGH to Power-Down		10		12	ns
Write Cycle^[9, 10]						
t_{WC}	Write Cycle Time	10		12		ns
t_{SCE}	\overline{CE} LOW to Write End	8		8		ns
t_{AW}	Address Set-Up to Write End	7		8		ns
t_{HA}	Address Hold from Write End	0		0		ns
t_{SA}	Address Set-Up to Write Start	0		0		ns
t_{PWE}	\overline{WE} Pulse Width	7		8		ns
t_{SD}	Data Set-Up to Write End	5		7		ns
t_{HD}	Data Hold from Write End	0		0		ns
t_{HZWE}	\overline{WE} LOW to High Z ^[9]		7		7	ns
t_{LZWE}	\overline{WE} HIGH to Low Z ^[7]	3		3		ns

Notes:

- Test conditions assume signal transition time of 3 ns or less, timing reference levels of 1.5V, input pulse levels of 0 to 3.0V, and output loading of the specified I_{OL}/I_{OH} and capacitance $C_L = 30$ pF.
- At any given temperature and voltage condition, t_{HZCE} is less than t_{LZCE} , t_{HZOE} is less than t_{LZOE} , and t_{HZWE} is less than t_{LZWE} for any given device.
- t_{HZOE} , t_{HZCE} , t_{HZWE} are specified with $C_L = 5$ pF as in AC Test Loads. Transition is measured ± 500 mV from steady state voltage.
- The internal write time of the memory is defined by the overlap of \overline{CE} LOW and \overline{WE} LOW. Both signals must be LOW to initiate a write and either signal can terminate a write by going HIGH. The data input set-up and hold timing should be referenced to the rising edge of the signal that terminates the write.
- The minimum write cycle time for write cycle #3 (\overline{WE} controlled, \overline{OE} LOW) is the sum of t_{HZWE} and t_{SD} .

Switching Characteristics Over the Operating Range^[6] (continued)

Parameter	Description	1399B-15		1399B-20		Unit
		Min.	Max.	Min.	Max.	
Read Cycle						
t _{RC}	Read Cycle Time	15		20		ns
t _{AA}	Address to Data Valid		15		20	ns
t _{OHA}	Data Hold from Address Change	3		3		ns
t _{ACE}	\overline{CE} LOW to Data Valid		15		20	ns
t _{DOE}	\overline{OE} LOW to Data Valid		6		7	ns
t _{LZOE}	\overline{OE} LOW to Low Z ^[7]	0		0		ns
t _{HZOE}	\overline{OE} HIGH to High Z ^[7, 8]		6		6	ns
t _{LZCE}	\overline{CE} LOW to Low Z ^[7]	3		3		ns
t _{HZCE}	\overline{CE} HIGH to High Z ^[7, 8]		7		7	ns
t _{PU}	\overline{CE} LOW to Power-Up	0		0		ns
t _{PD}	\overline{CE} HIGH to Power-Down		15		20	ns
Write Cycle^[9, 10]						
t _{WC}	Write Cycle Time	15		20		ns
t _{SCE}	\overline{CE} LOW to Write End	10		12		ns
t _{AW}	Address Set-Up to Write End	10		12		ns
t _{HA}	Address Hold from Write End	0		0		ns
t _{SA}	Address Set-Up to Write Start	0		0		ns
t _{PWE}	\overline{WE} Pulse Width	10		12		ns
t _{SD}	Data Set-Up to Write End	8		10		ns
t _{HD}	Data Hold from Write End	0		0		ns
t _{HZWE}	\overline{WE} LOW to High Z ^[9]		7		7	ns
t _{LZWE}	\overline{WE} HIGH to Low Z ^[7]	3		3		ns

Data Retention Characteristics (Over the Operating Range - L version only)

Parameter	Description	Conditions	Min.	Max.	Unit
V _{DR}	V _{CC} for Data Retention		2.0		V
I _{CCDR}	Data Retention Current	V _{CC} = V _{DR} = 2.0V, CE ≥ V _{CC} - 0.3V, V _{IN} ≥ V _{CC} - 0.3V or V _{IN} ≤ 0.3V	0	20	μA
t _{CDR}	Chip Deselect to Data Retention Time		0		ns
t _R	Operation Recovery Time		t _{RC}		ns

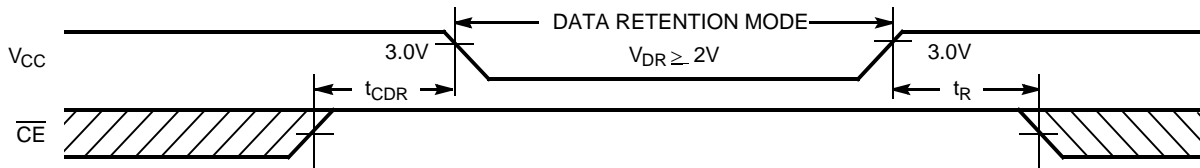
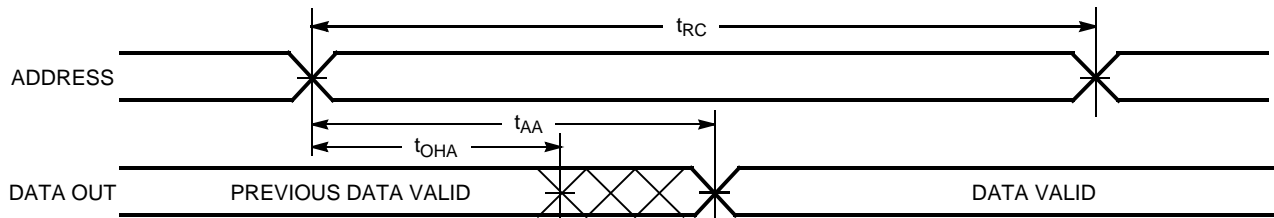
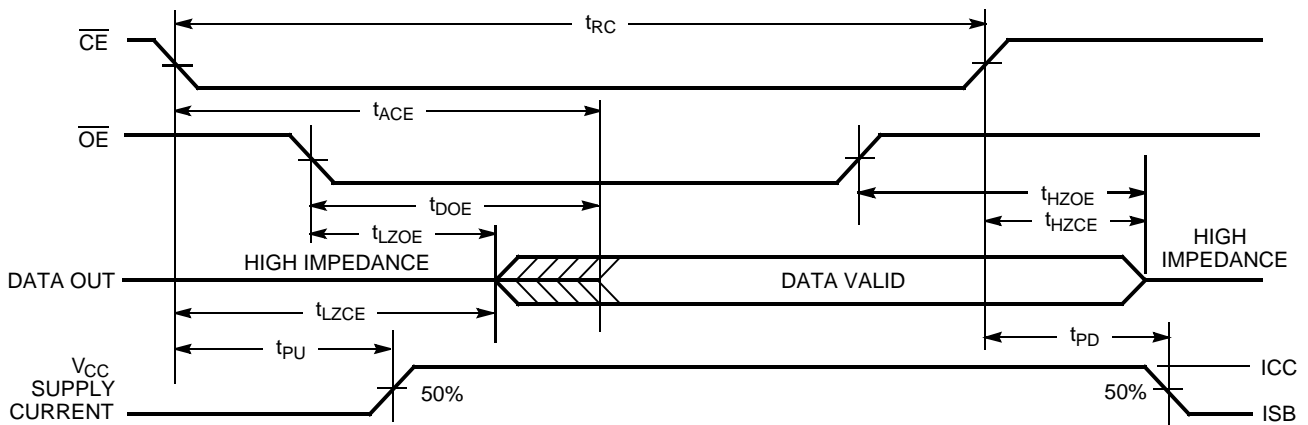
Data Retention Waveform

Switching Waveforms
Read Cycle No. 1^[11, 12]

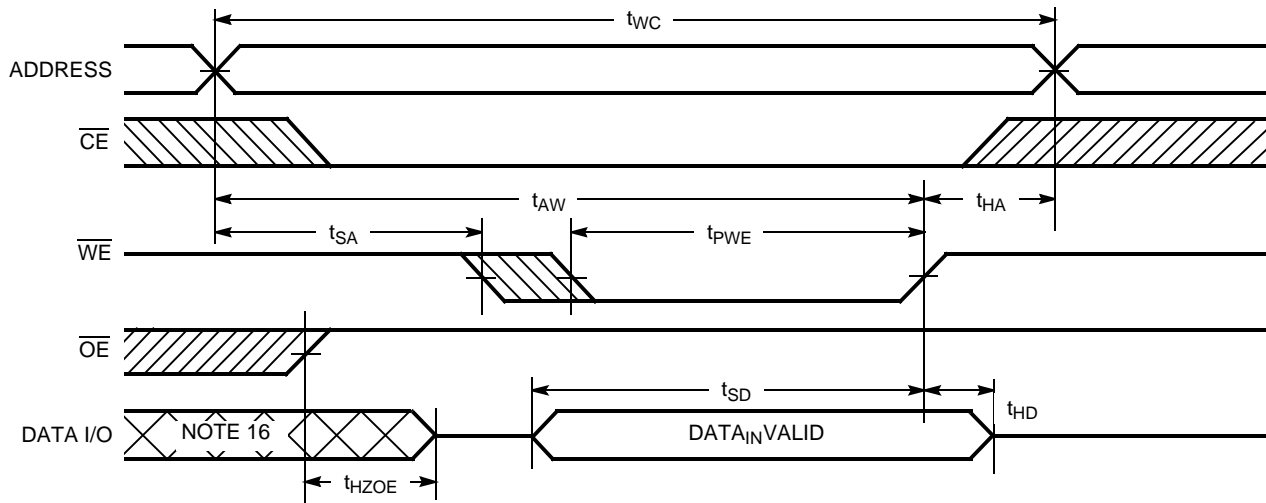
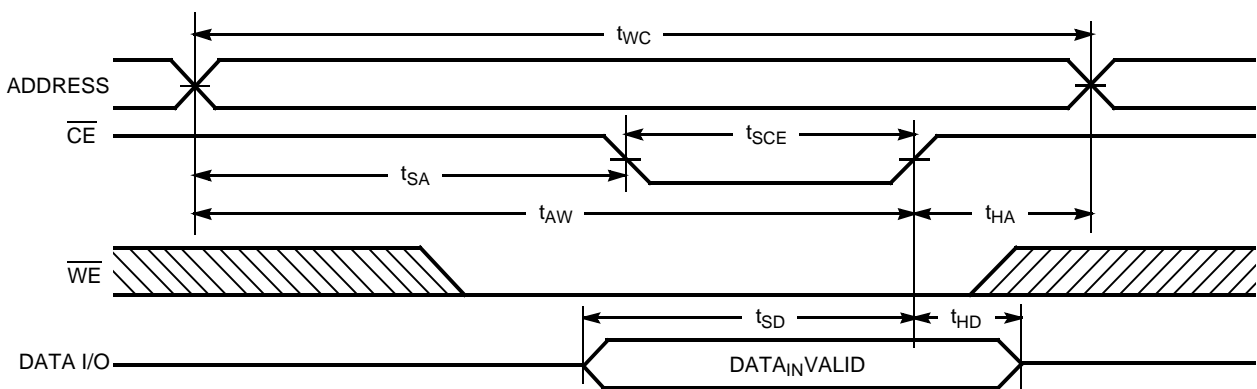
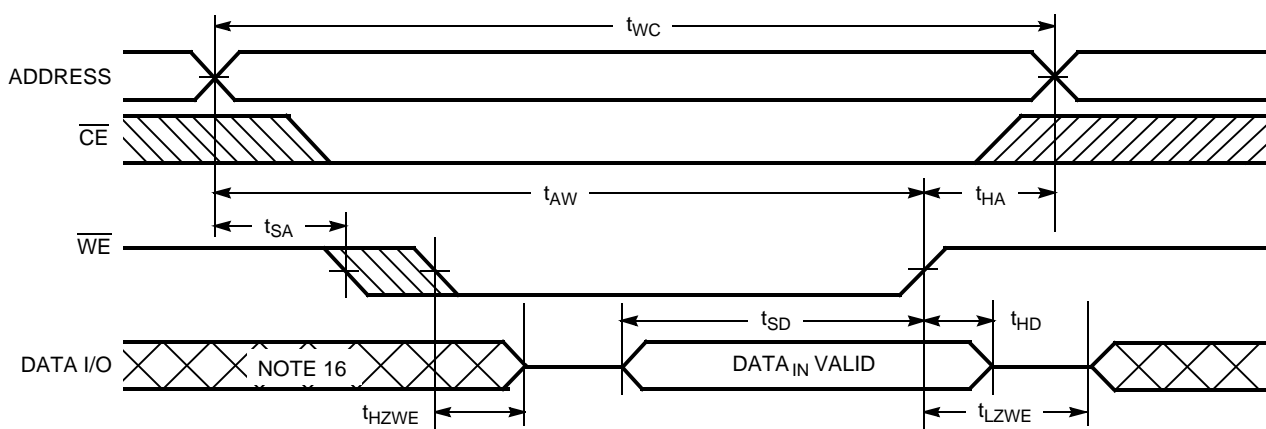
Read Cycle No. 2^[12, 13]

Notes:

11. Device is continuously selected. \overline{OE} , $\overline{CE} = V_{IL}$.
12. \overline{WE} is HIGH for read cycle.
13. Address valid prior to or coincident with \overline{CE} transition LOW.

Switching Waveforms (continued)
Write Cycle No. 1 (\overline{WE} Controlled)^[9, 14, 15]

Write Cycle No. 2 (\overline{CE} Controlled)^[9, 14, 15]

Write Cycle No. 3 (\overline{WE} Controlled, \overline{OE} LOW)^[10, 15]

Notes:

14. Data I/O is high impedance if $\overline{OE} = V_{IH}$.
15. If \overline{CE} goes HIGH simultaneously with \overline{WE} HIGH, the output remains in a high-impedance state.
16. During this period, the I/Os are in the output state and input signals should not be applied.

Truth Table

CE	WE	OE	Input/Output	Mode	Power
H	X	X	High Z	Deselect/Power-Down	Standby (I_{SB})
L	H	L	Data Out	Read	Active (I_{CC})
L	L	X	Data In	Write	Active (I_{CC})
L	H	H	High Z	Deselect, Output Disabled	Active (I_{CC})

Ordering Information

Speed (ns)	Ordering Code	Package Name	Package Type	Operating Range
12	CY7C1399B-12VC	V21	28-Lead Molded SOJ	Commercial
	CY7C1399B-12VXC	V21	28-Lead Molded SOJ (Pb-Free)	
	CY7C1399B-12ZC	Z28	28-Lead Thin Small Outline Package	
	CY7C1399B-12ZXC	Z28	28-Lead Thin Small Outline Package (Pb-Free)	
	CY7C1399BL-12ZC	Z28	28-Lead Thin Small Outline Package	
	CY7C1399BL-12ZXC	Z28	28-Lead Thin Small Outline Package (Pb-Free)	
	CY7C1399B-12VXI	V21	28-Lead Molded SOJ (Pb-Free)	Industrial
15	CY7C1399B-15VC	V21	28-Lead Molded SOJ	Commercial
	CY7C1399B-15VXC	V21	28-Lead Molded SOJ (Pb-Free)	
	CY7C1399B-15ZC	Z28	28-Lead Thin Small Outline Package	
	CY7C1399B-15ZXC	Z28	28-Lead Thin Small Outline Package (Pb-Free)	
	CY7C1399BL-15VC	V21	28-Lead Molded SOJ	
	CY7C1399BL-15VXC	V21	28-Lead Molded SOJ (Pb-Free)	
	CY7C1399BL-15ZXC	Z28	28-Lead Thin Small Outline Package (Pb-Free)	
	CY7C1399B-15VI	V21	28-Lead Molded SOJ	Industrial
	CY7C1399B-15VXI	V21	28-Lead Molded SOJ (Pb-Free)	
	CY7C1399B-15ZI	Z28	28-Lead Thin Small Outline Package	
	CY7C1399B-15ZXI	Z28	28-Lead Thin Small Outline Package (Pb-Free)	
20	CY7C1399B-20ZC	Z28	28-Lead Thin Small Outline Package	Commercial
	CY7C1399B-20ZXC	Z28	28-Lead Thin Small Outline Package (Pb-Free)	

Package Diagrams
28-Lead (300-Mil) Molded SOJ V21

DIMENSIONS IN INCHES

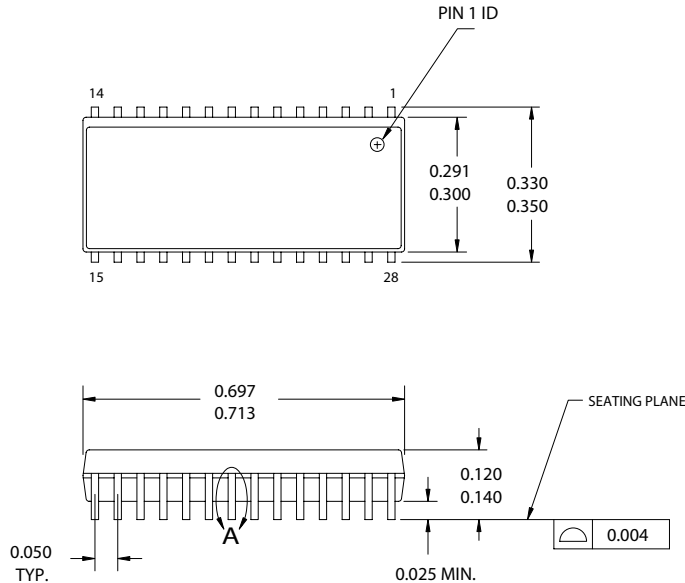
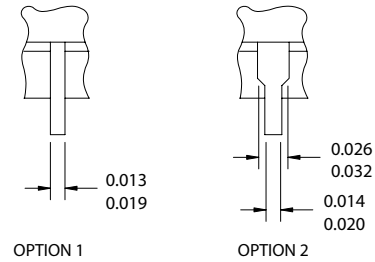
 MIN.
MAX.

 DETAIL **A**
EXTERNAL LEAD DESIGN

51-85031-*B

28-Lead Thin Small Outline Package Type 1 (8x13.4 mm) Z28

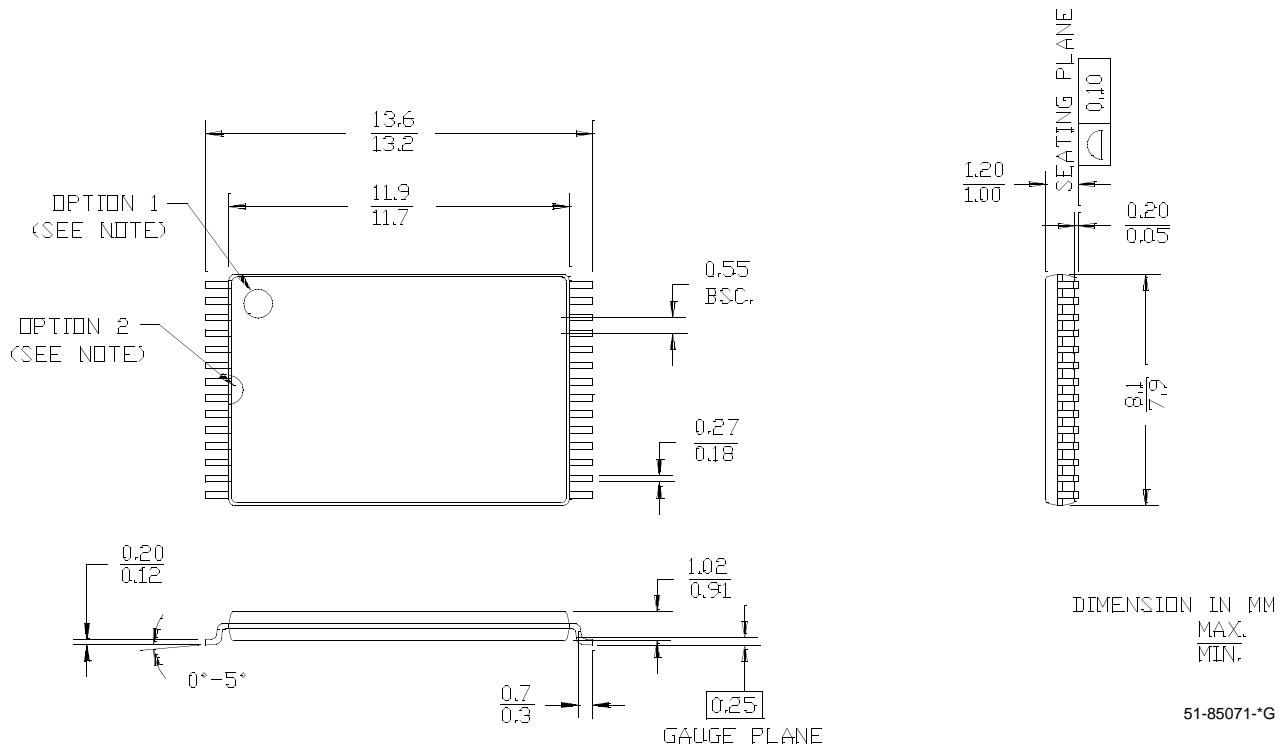
NOTE: ORIENTATION I.D. MAY BE LOCATED EITHER AS SHOWN IN OPTION 1 OR OPTION 2

 DIMENSION IN MM
MAX.
MIN.

51-85071-*G

All products and company names mentioned in this document may be the trademarks of their respective holders.

Document History Page

Document Title: CY7C1399B 256K(32K x 8) Static RAM Document Number: 38-05071				
REV.	ECN NO.	ISSUE DATE	ORIG. OF CHANGE	DESCRIPTION OF CHANGE
**	107264	05/25/01	SZV	Change from Spec #: 38-01102 to 38-05071
*A	107533	06/28/01	MAX	Add Low Power
*B	116472	09/17/02	CEA	Add applications foot note to data sheet, page 1.
*C	224340	See ECN	RKF	Option 1 of the Orientation ID on TSOP-I Package Diagram [Page #9] removed
*D	386100	See ECN	SYT	Converted the Datasheet from "Preliminary" to "Final" Added Pb-Free offerings in the Ordering Information Edited the title to "256K (32K x 8) Static RAM" from "32K x 8 3.3V Static RAM"