

256K x 16 Static RAM

Features

- **High speed**
— $t_{AA} = 15 \text{ ns}$
- **Low active power**
— 1430 mW (max.)
- **Low CMOS standby power (L version)**
— 2.75 mW (max.)
- **2.0V Data Retention (400 μW at 2.0V retention)**
- **Automatic power-down when deselected**
- **TTL-compatible inputs and outputs**
- **Easy memory expansion with $\overline{\text{CE}}$ and $\overline{\text{OE}}$ features**

Functional Description

The CY7C1041 is a high-performance CMOS static RAM organized as 262,144 words by 16 bits.

Writing to the device is accomplished by taking Chip Enable ($\overline{\text{CE}}$) and Write Enable ($\overline{\text{WE}}$) inputs LOW. If Byte Low Enable ($\overline{\text{BLE}}$) is LOW, then data from I/O pins (I/O_0 through I/O_7), is

written into the location specified on the address pins (A_0 through A_{17}). If Byte High Enable ($\overline{\text{BHE}}$) is LOW, then data from I/O pins (I/O_8 through I/O_{15}) is written into the location specified on the address pins (A_0 through A_{17}).

Reading from the device is accomplished by taking Chip Enable ($\overline{\text{CE}}$) and Output Enable ($\overline{\text{OE}}$) LOW while forcing the Write Enable ($\overline{\text{WE}}$) HIGH. If Byte Low Enable ($\overline{\text{BLE}}$) is LOW, then data from the memory location specified by the address pins will appear on I/O_0 to I/O_7 . If Byte High Enable ($\overline{\text{BHE}}$) is LOW, then data from memory will appear on I/O_8 to I/O_{15} . See the truth table at the back of this data sheet for a complete description of read and write modes.

The input/output pins (I/O_0 through I/O_{15}) are placed in a high-impedance state when the device is deselected ($\overline{\text{CE}}$ HIGH), the outputs are disabled ($\overline{\text{OE}}$ HIGH), the $\overline{\text{BHE}}$ and $\overline{\text{BLE}}$ are disabled ($\overline{\text{BHE}}$, $\overline{\text{BLE}}$ HIGH), or during a write operation ($\overline{\text{CE}}$ LOW, and $\overline{\text{WE}}$ LOW).

The CY7C1041 is available in a standard 44-pin 400-mil-wide body width SOJ and 44-pin TSOP II package with center power and ground (revolutionary) pinout.

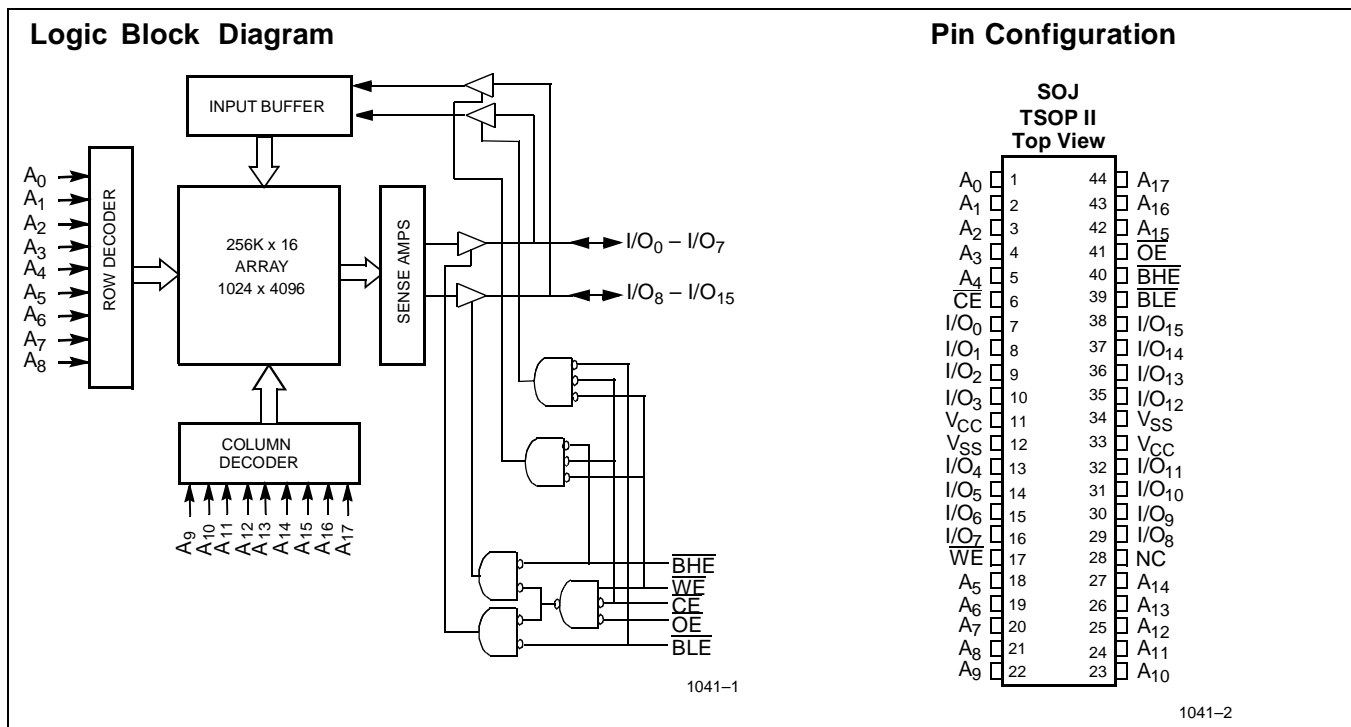

Selection Guide

		7C1041-12	7C1041-15	7C1041-17	7C1041-20	7C1041-25
Maximum Access Time (ns)		12	15	17	20	25
Maximum Operating Current (mA)		280	260	250	230	220
Maximum CMOS Standby Current (mA)	Com'l	3	3	3	3	3
	Com'l	L	0.5	0.5	0.5	0.5
	Ind'l		6	6	6	6

Shaded areas contain preliminary information.

Maximum Ratings

(Above which the useful life may be impaired. For user guidelines, not tested.)

Storage Temperature -65°C to +150°C
 Ambient Temperature with Power Applied -55°C to +125°C
 Supply Voltage on V_{CC} to Relative GND^[1] -0.5V to +7.0V
 DC Voltage Applied to Outputs in High Z State^[1] -0.5V to $V_{CC} + 0.5V$

DC Input Voltage^[1] -0.5V to $V_{CC} + 0.5V$
 Current into Outputs (LOW) 20 mA

Operating Range

Range	Ambient Temperature ^[2]	V_{CC}
Commercial	0°C to +70°C	5V ± 0.5
Industrial	-40°C to +85°C	

Electrical Characteristics Over the Operating Range

Parameter	Description	Test Conditions	7C1041-12		7C1041-15		7C1041-17		Unit	
			Min.	Max.	Min.	Max.	Min.	Max.		
V_{OH}	Output HIGH Voltage	$V_{CC} = \text{Min.}, I_{OH} = -4.0 \text{ mA}$	2.4		2.4		2.4		V	
V_{OL}	Output LOW Voltage	$V_{CC} = \text{Min.}, I_{OL} = 8.0 \text{ mA}$		0.4		0.4		0.4	V	
V_{IH}	Input HIGH Voltage		2.2	$V_{CC} + 0.5$	2.2	$V_{CC} + 0.5$	2.2	$V_{CC} + 0.5$	V	
V_{IL}	Input LOW Voltage ^[1]		-0.5	0.8	-0.5	0.8	-0.5	0.8	V	
I_{IX}	Input Load Current	$GND \leq V_I \leq V_{CC}$	-1	+1	-1	+1	-1	+1	µA	
I_{OZ}	Output Leakage Current	$GND \leq V_{OUT} \leq V_{CC}$, Output Disabled	-1	+1	-1	+1	-1	+1	µA	
I_{CC}	V_{CC} Operating Supply Current	$V_{CC} = \text{Max.}, f = f_{MAX} = 1/t_{RC}$		280		260		250	mA	
I_{SB1}	Automatic CE Power-Down Current —TTL Inputs	Max. V_{CC} , $\overline{CE} \geq V_{IH}$ $V_{IN} \geq V_{IH}$ or $V_{IN} \leq V_{IL}$, $f = f_{MAX}$		40		40		40	mA	
I_{SB2}	Automatic CE Power-Down Current —CMOS Inputs	Max. V_{CC} , $\overline{CE} \geq V_{CC} - 0.3V$, $V_{IN} \geq V_{CC} - 0.3V$, or $V_{IN} \leq 0.3V$, $f = 0$	Com'l			3		3	3	mA
			Com'l	L		0.5		0.5	0.5	mA
			Ind'l			6		6	6	mA

Shaded areas contain preliminary information.

Notes:

- V_{IL} (min.) = -2.0V for pulse durations of less than 20 ns.
- T_A is the case temperature.

Electrical Characteristics Over the Operating Range (continued)

Parameter	Description	Test Conditions	7C1041-20		7C1041-25		Unit	
			Min.	Max.	Min.	Max.		
V_{OH}	Output HIGH Voltage	$V_{CC} = \text{Min.}, I_{OH} = -4.0 \text{ mA}$	2.4		2.4		V	
V_{OL}	Output LOW Voltage	$V_{CC} = \text{Min.}, I_{OL} = 8.0 \text{ mA}$		0.4		0.4	V	
V_{IH}	Input HIGH Voltage		2.2	$V_{CC} + 0.5$	2.2	$V_{CC} + 0.5$	V	
V_{IL}	Input LOW Voltage ^[1]		-0.5	0.8	-0.5	0.8	V	
I_{IX}	Input Load Current	$GND \leq V_I \leq V_{CC}$	-1	+1	-1	+1	μA	
I_{OZ}	Output Leakage Current	$GND \leq V_{OUT} \leq V_{CC}$, Output Disabled	-1	+1	-1	+1	μA	
I_{CC}	V_{CC} Operating Supply Current	$V_{CC} = \text{Max.},$ $f = f_{\text{MAX}} = 1/t_{RC}$		230		220	mA	
I_{SB1}	Automatic CE Power-Down Current —TTL Inputs	Max. V_{CC} , $\overline{CE} \geq V_{IH}$ $V_{IN} \geq V_{IH}$ or $V_{IN} \leq V_{IL}$, $f = f_{\text{MAX}}$		40		40	mA	
I_{SB2}	Automatic CE Power-Down Current —CMOS Inputs	Max. V_{CC} , $\overline{CE} \geq V_{CC} - 0.3\text{V}$, $V_{IN} \geq V_{CC} - 0.3\text{V}$, or $V_{IN} \leq 0.3\text{V}$, $f = 0$	Com'l		3		3	mA
			Com'l L		0.5		0.5	mA
			Ind'l		6		6	mA

Capacitance^[3]

Parameter	Description	Test Conditions	Max.	Unit
C_{IN}	Input Capacitance	$T_A = 25^\circ\text{C}$, $f = 1 \text{ MHz}$, $V_{CC} = 5.0\text{V}$	8	pF
C_{OUT}	I/O Capacitance		8	pF

Note:

3. Tested initially and after any design or process changes that may affect these parameters.

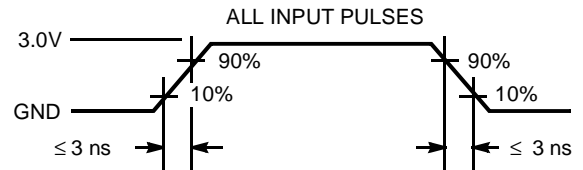
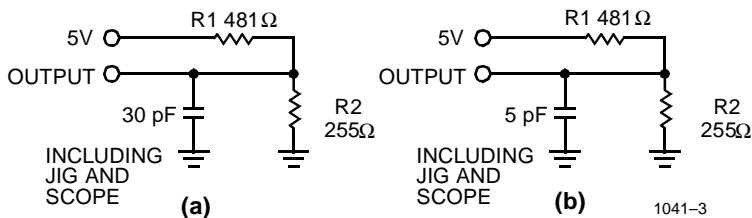
AC Test Loads and Waveforms

1041-4

Equivalent to: THÉVENIN EQUIVALENT

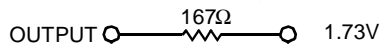

Switching Characteristics^[4] Over the Operating Range

Parameter	Description	7C1041-12		7C1041-15		7C1041-17		Unit
		Min.	Max.	Min.	Max.	Min.	Max.	
READ CYCLE								
t_{RC}	Read Cycle Time	12		15		17		ns
t_{AA}	Address to Data Valid		12		15		17	ns
t_{OHA}	Data Hold from Address Change	3		3		3		ns
t_{ACE}	\overline{CE} LOW to Data Valid		12		15		17	ns
t_{DOE}	\overline{OE} LOW to Data Valid		6		7		7	ns
t_{LZOE}	\overline{OE} LOW to Low Z	0		0		0		ns
t_{HZOE}	\overline{OE} HIGH to High Z ^[5, 6]		6		7		7	ns
t_{LZCE}	\overline{CE} LOW to Low Z ^[6]	3		3		3		ns
t_{HZCE}	\overline{CE} HIGH to High Z ^[5, 6]		6		7		7	ns
t_{PU}	\overline{CE} LOW to Power-Up	0		0		0		ns
t_{PD}	\overline{CE} HIGH to Power-Down		12		15		17	ns
t_{DBE}	Byte Enable to Data Valid		6		7		7	ns
t_{LZBE}	Byte Enable to Low Z	0		0		0		ns
t_{HZBE}	Byte Disable to High Z		6		7		7	ns
WRITE CYCLE^[7, 8]								
t_{WC}	Write Cycle Time	12		15		17		ns
t_{SCE}	\overline{CE} LOW to Write End	10		12		14		ns
t_{AW}	Address Set-Up to Write End	10		12		14		ns
t_{HA}	Address Hold from Write End	0		0		0		ns
t_{SA}	Address Set-Up to Write Start	0		0		0		ns
t_{PWE}	\overline{WE} Pulse Width	10		12		14		ns
t_{SD}	Data Set-Up to Write End	7		8		8		ns
t_{HD}	Data Hold from Write End	0		0		0		ns
t_{LZWE}	\overline{WE} HIGH to Low Z ^[6]	3		3		3		ns
t_{HZWE}	\overline{WE} LOW to High Z ^[5, 6]		6		7		7	ns
t_{BW}	Byte Enable to End of Write	10		12		12		ns

Shaded areas contain preliminary information.

Notes:

- Test conditions assume signal transition time of 3 ns or less, timing reference levels of 1.5V, input pulse levels of 0 to 3.0V, and output loading of the specified I_{OL}/I_{OH} and 30-pF load capacitance.
- t_{HZOE} , t_{HZCE} , and t_{HZWE} are specified with a load capacitance of 5 pF as in part (b) of AC Test Loads. Transition is measured ± 500 mV from steady-state voltage.
- At any given temperature and voltage condition, t_{HZCE} is less than t_{LZCE} , t_{HZOE} is less than t_{LZOE} , and t_{HZWE} is less than t_{LZWE} for any given device.
- The internal write time of the memory is defined by the overlap of \overline{CE} LOW, and \overline{WE} LOW. \overline{CE} and \overline{WE} must be LOW to initiate a write, and the transition of either of these signals can terminate the write. The input data set-up and hold timing should be referenced to the leading edge of the signal that terminates the write.
- The minimum write cycle time for Write Cycle No. 3 (WE controlled, OE LOW) is the sum of t_{HZWE} and t_{SD} .

Switching Characteristics^[4] Over the Operating Range (continued)

Parameter	Description	7C1041-20		7C1041-25		Unit
		Min.	Max.	Min.	Max.	
READ CYCLE						
t _{RC}	Read Cycle Time	20		25		ns
t _{AA}	Address to Data Valid		20		25	ns
t _{OHA}	Data Hold from Address Change	3		5		ns
t _{ACE}	\overline{CE} LOW to Data Valid		20		25	ns
t _{DOE}	\overline{OE} LOW to Data Valid		8		10	ns
t _{LZOE}	\overline{OE} LOW to Low Z	0		0		ns
t _{HZOE}	\overline{OE} HIGH to High Z ^[5, 6]		8		10	ns
t _{LZCE}	\overline{CE} LOW to Low Z ^[6]	3		5		ns
t _{HZCE}	\overline{CE} HIGH to High Z ^[5, 6]		8		10	ns
t _{PU}	\overline{CE} LOW to Power-Up	0		0		ns
t _{PD}	\overline{CE} HIGH to Power-Down		20		25	ns
t _{DBE}	Byte Enable to Data Valid		8		10	ns
t _{LZBE}	Byte Enable to Low Z	0		0		ns
t _{HZBE}	Byte Disable to High Z		8		10	ns
WRITE CYCLE^[7, 8]						
t _{WC}	Write Cycle Time	20		25		ns
t _{SCE}	\overline{CE} LOW to Write End	13		15		ns
t _{AW}	Address Set-Up to Write End	13		15		ns
t _{HA}	Address Hold from Write End	0		0		ns
t _{SA}	Address Set-Up to Write Start	0		0		ns
t _{PWE}	\overline{WE} Pulse Width	13		15		ns
t _{SD}	Data Set-Up to Write End	9		10		ns
t _{HD}	Data Hold from Write End	0		0		ns
t _{LZWE}	\overline{WE} HIGH to Low Z ^[6]	3		5		ns
t _{HZWE}	\overline{WE} LOW to High Z ^[5, 6]		8		10	ns
t _{BW}	Byte Enable to End of Write	13		15		ns

Data Retention Characteristics Over the Operating Range

Parameter	Description	Conditions ^[10]	Min.	Max.	Unit	
V _{DR}	V _{CC} for Data Retention		2.0		V	
I _{CCDR}	Data Retention Current	V _{CC} = V _{DR} = 2.0V, CE ≥ V _{CC} - 0.3V, V _{IN} ≥ V _{CC} - 0.3V or V _{IN} ≤ 0.3V			μA	
			Com'l L		200	μA
						μA
t _{CDR^[3]}	Chip Deselect to Data Retention Time		0		ns	
t _{R^[9]}	Operation Recovery Time		See Note 9			

Notes:

9. t_r ≤ 100 μs for all speeds.
10. No input may exceed V_{CC} + 0.5V.

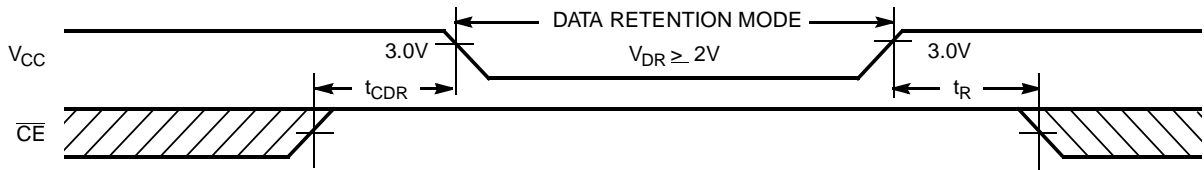
Data Retention Waveform

1041-5

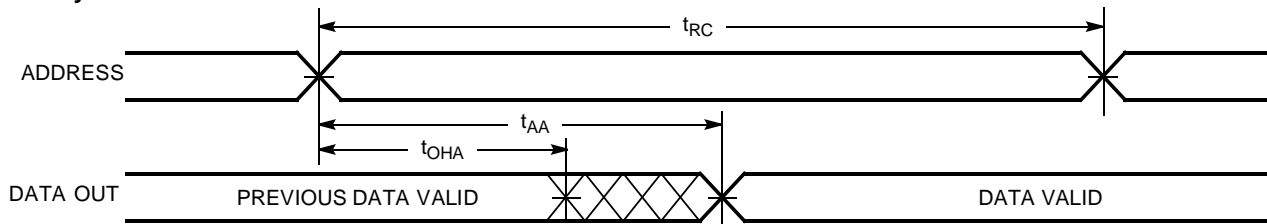
Switching Waveforms
Read Cycle No.1 ^[11, 12]

1041-6

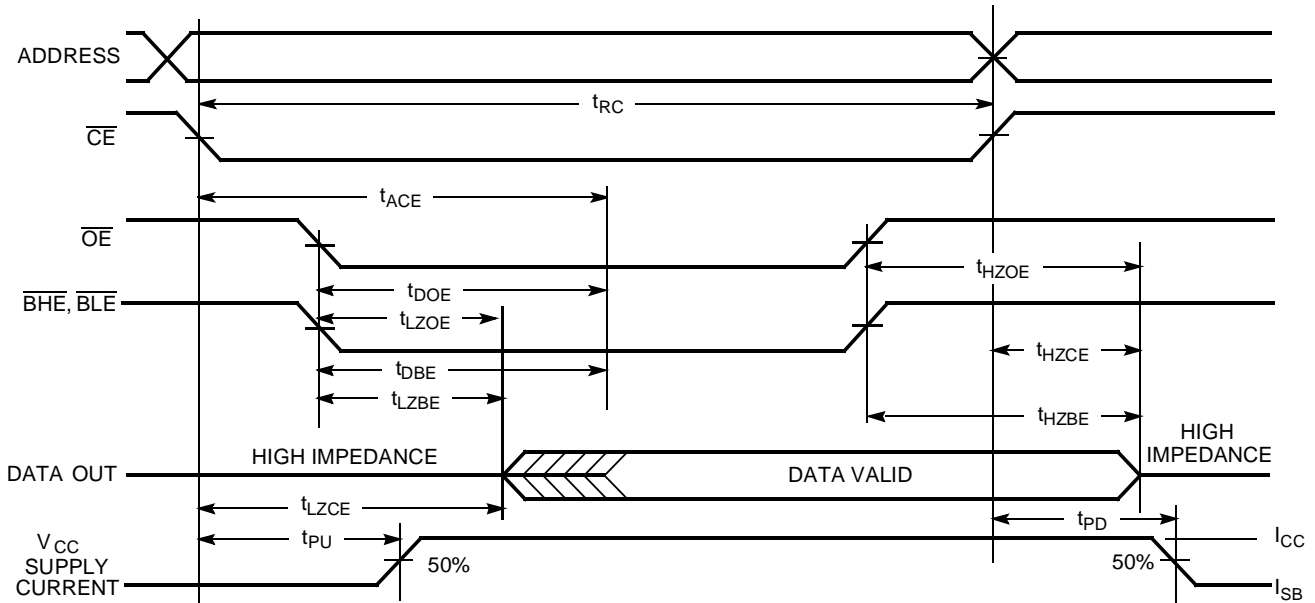
Read Cycle No.2 (\overline{OE} Controlled) ^[12, 13]

1041-7

Notes:

11. Device is continuously selected. \overline{OE} , \overline{CE} , \overline{BHE} , and/or \overline{BLE} = V_{IL} .
12. \overline{WE} is HIGH for read cycle.
13. Address valid prior to or coincident with \overline{CE} transition LOW.

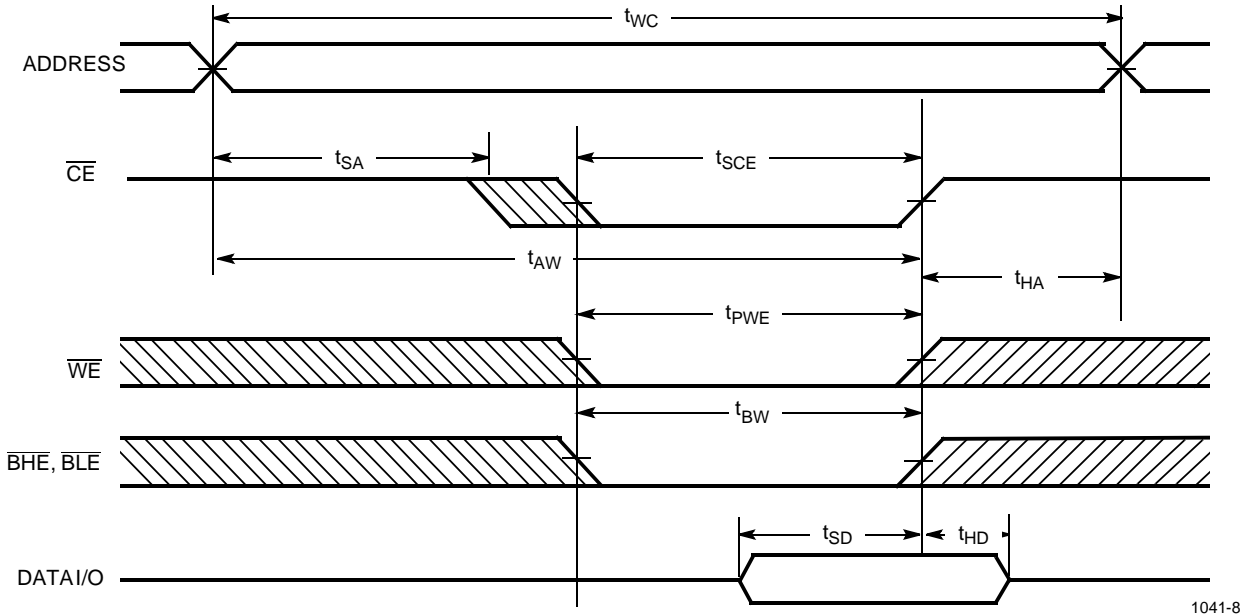
Switching Waveforms (continued)
Write Cycle No. 1 (\overline{CE} Controlled) ^[14, 15]

1041-8

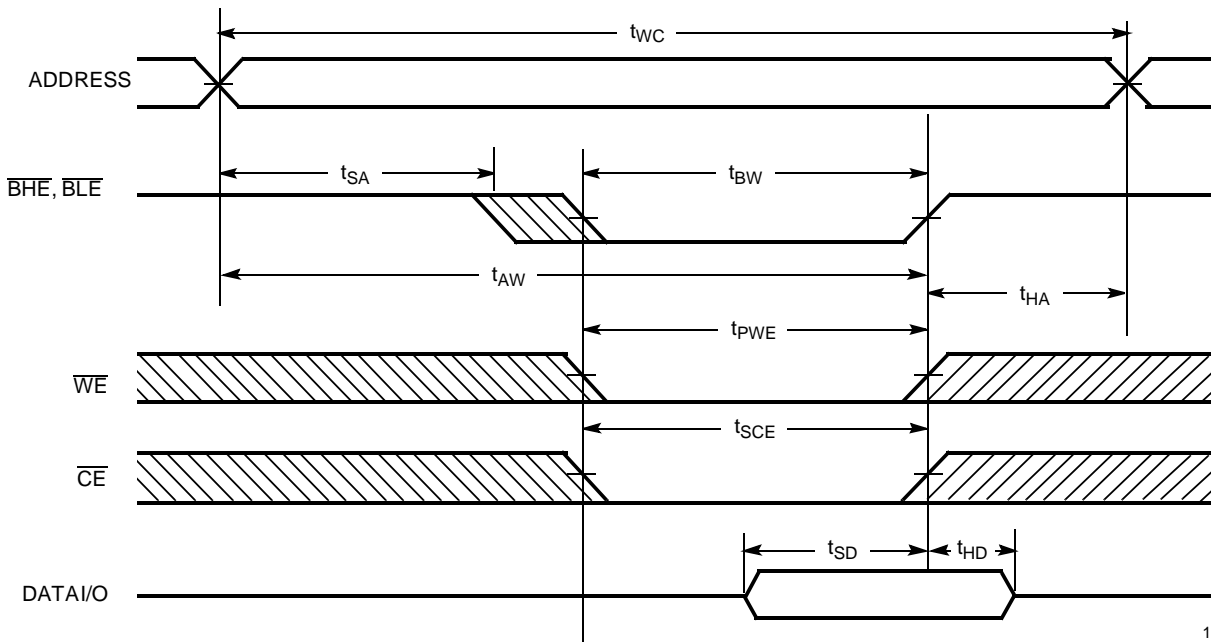
Write Cycle No. 2 (\overline{BLE} or \overline{BHE} Controlled)

1041-9

Notes:

14. Data I/O is high impedance if \overline{OE} or \overline{BHE} and/or $\overline{BLE} = V_{IH}$.
15. If \overline{CE} goes HIGH simultaneously with \overline{WE} going HIGH, the output remains in a high-impedance state.

Switching Waveforms (continued)

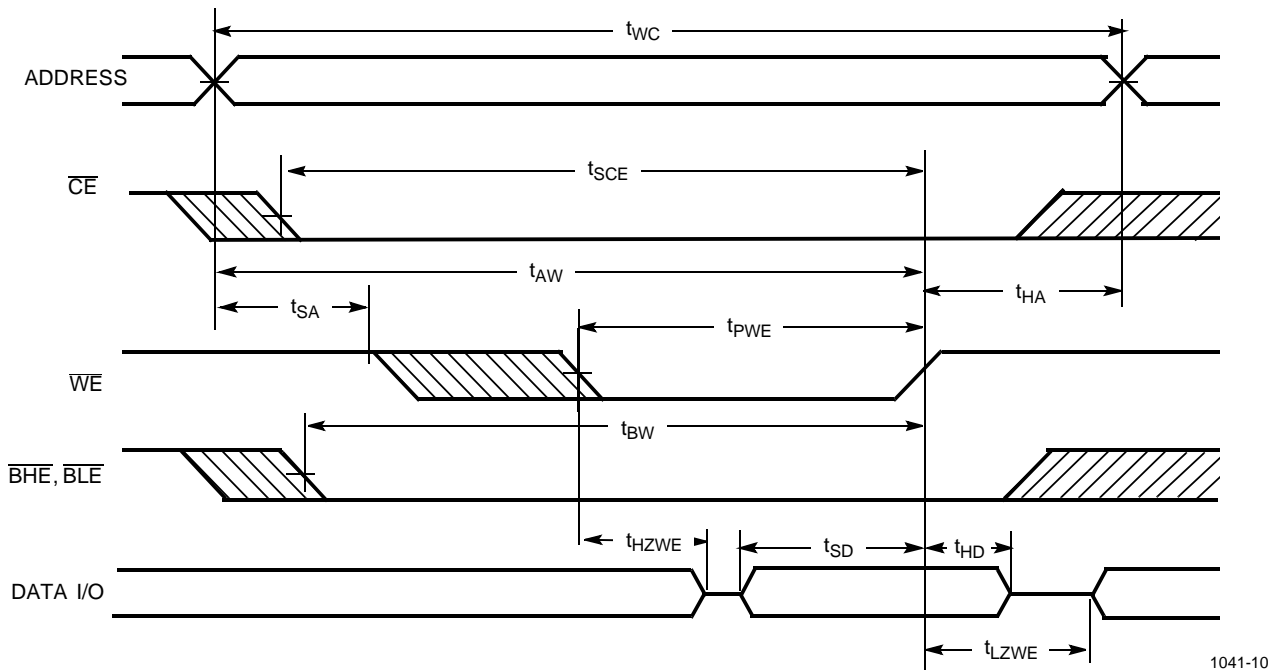
Write Cycle No.3 (\overline{WE} Controlled, LOW)

1041-10

Truth Table

\overline{CE}	\overline{OE}	\overline{WE}	\overline{BLE}	\overline{BHE}	$I/O_0-I/O_7$	$I/O_8-I/O_{15}$	Mode	Power
H	X	X	X	X	High Z	High Z	Power Down	Standby (I_{SB})
L	L	H	L	L	Data Out	Data Out	Read All Bits	Active (I_{CC})
L	L	H	L	H	Data Out	High Z	Read Lower Bits Only	Active (I_{CC})
L	L	H	H	L	High Z	Data Out	Read Upper Bits Only	Active (I_{CC})
L	X	L	L	L	Data In	Data In	Write All Bits	Active (I_{CC})
L	X	L	L	H	Data In	High Z	Write Lower Bits Only	Active (I_{CC})
L	X	L	H	L	High Z	Data In	Write Upper Bits Only	Active (I_{CC})
L	H	H	X	X	High Z	High Z	Selected, Outputs Disabled	Active (I_{CC})

Ordering Information

Speed (ns)	Ordering Code	Package Name	Package Type	Operating Range
15	CY7C1041-15VC	V34	44-Lead (400-Mil) Molded SOJ	Commercial
	CY7C1041L-15VC	V34	44-Lead (400-Mil) Molded SOJ	
	CY7C1041-15ZC	Z44	44-Lead TSOP Type II	
	CY7C1041L-15ZC	Z44	44-Lead TSOP Type II	
17	CY7C1041-17VC	V34	44-Lead (400-Mil) Molded SOJ	
	CY7C1041L-17VC	V34	44-Lead (400-Mil) Molded SOJ	
	CY7C1041-17ZC	Z44	44-Lead TSOP Type II	
	CY7C1041L-17ZC	Z44	44-Lead TSOP Type II	
20	CY7C1041-20VC	V34	44-Lead (400-Mil) Molded SOJ	
	CY7C1041L-20VC	V34	44-Lead (400-Mil) Molded SOJ	
	CY7C1041-20ZC	Z44	44-Lead TSOP Type II	
	CY7C1041L-20ZC	Z44	44-Lead TSOP Type II	
25	CY7C1041-25VC	V34	44-Lead (400-Mil) Molded SOJ	
	CY7C1041L-25VC	V34	44-Lead (400-Mil) Molded SOJ	
	CY7C1041-25ZC	Z44	44-Lead TSOP Type II	
	CY7C1041L-25ZC	Z44	44-Lead TSOP Type II	
15	CY7C1041-15ZI	Z44	44-Lead TSOP Type II	Industrial
	CY7C1041-15VI	V34	44-Lead (400-Mil) Molded SOJ	
17	CY7C1041-17ZI	V34	44-Lead TSOP Type II	
	CY7C1041-17VI	Z44	44-Lead (400-Mil) Molded SOJ	
20	CY7C1041-20ZI	Z44	44-Lead TSOP Type II	
	CY7C1041-20VI	Z44	44-Lead (400-Mil) Molded SOJ	
25	CY7C1041-25ZI	Z44	44-Lead TSOP Type II	
	CY7C1041-25VI	Z44	44-Lead (400-Mil) Molded SOJ	

Document #: 38-00644-B

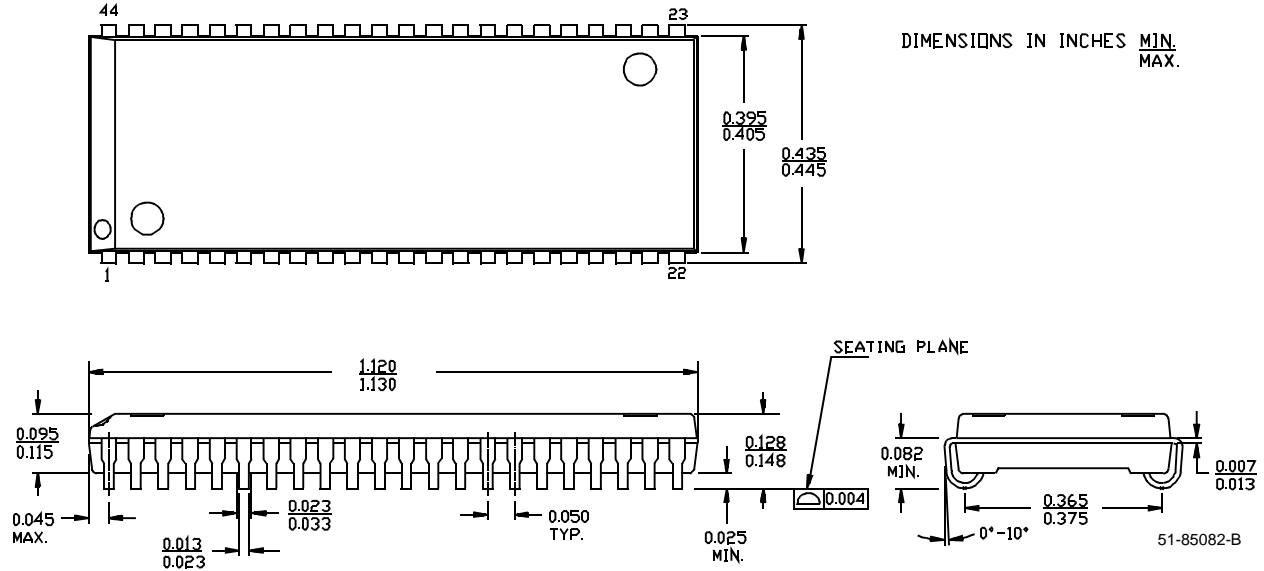
Package Diagrams
44-Lead (400-Mil) Molded SOJ V34

44-Pin TSOP II Z44

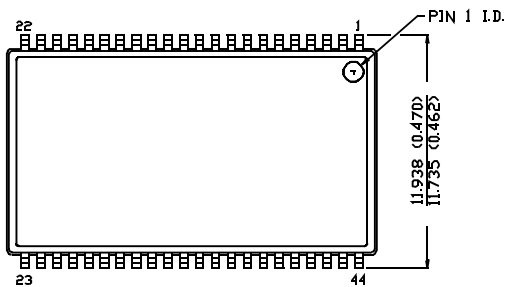
DIMENSION IN MM (INCH)
MAX
MIN.

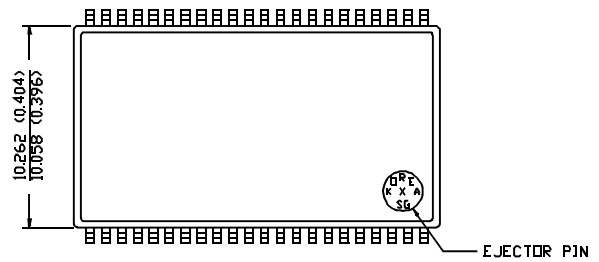

TOP VIEW



BOTTOM VIEW

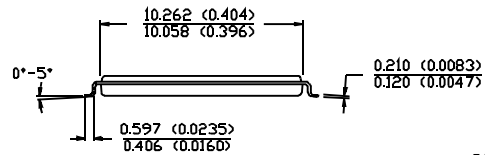
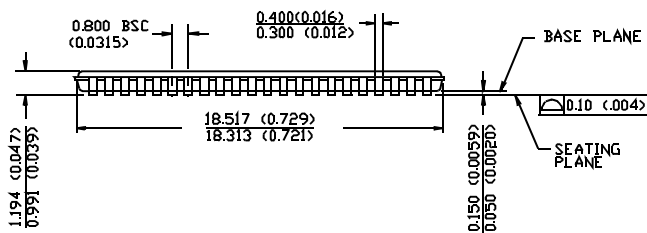

51-85087-A

© Cypress Semiconductor Corporation, 1999. The information contained herein is subject to change without notice. Cypress Semiconductor Corporation assumes no responsibility for the use of any circuitry other than circuitry embodied in a Cypress Semiconductor product. Nor does it convey or imply any license under patent or other rights. Cypress Semiconductor does not authorize its products for use as critical components in life-support systems where a malfunction or failure may reasonably be expected to result in significant injury to the user. The inclusion of Cypress Semiconductor products in life-support systems application implies that the manufacturer assumes all risk of such use and in doing so indemnifies Cypress Semiconductor against all charges.