

# 256K x 16 Static RAM

## Features

- **High speed**  
—  $t_{AA} = 15 \text{ ns}$
- **Low active power**  
— 1430 mW (max.)
- **Low CMOS standby power (L version)**  
— 2.75 mW (max.)
- **2.0V Data Retention (400  $\mu\text{W}$  at 2.0V retention)**
- **Automatic power-down when deselected**
- **TTL-compatible inputs and outputs**
- **Easy memory expansion with  $\overline{\text{CE}}$  and  $\overline{\text{OE}}$  features**

## Functional Description

The CY7C1041 is a high-performance CMOS static RAM organized as 262,144 words by 16 bits.

Writing to the device is accomplished by taking Chip Enable ( $\overline{\text{CE}}$ ) and Write Enable ( $\overline{\text{WE}}$ ) inputs LOW. If Byte Low Enable ( $\overline{\text{BLE}}$ ) is LOW, then data from I/O pins ( $\text{I/O}_0$  through  $\text{I/O}_7$ ), is

written into the location specified on the address pins ( $\text{A}_0$  through  $\text{A}_{17}$ ). If Byte High Enable ( $\overline{\text{BHE}}$ ) is LOW, then data from I/O pins ( $\text{I/O}_8$  through  $\text{I/O}_{15}$ ) is written into the location specified on the address pins ( $\text{A}_0$  through  $\text{A}_{17}$ ).

Reading from the device is accomplished by taking Chip Enable ( $\overline{\text{CE}}$ ) and Output Enable ( $\overline{\text{OE}}$ ) LOW while forcing the Write Enable ( $\overline{\text{WE}}$ ) HIGH. If Byte Low Enable ( $\overline{\text{BLE}}$ ) is LOW, then data from the memory location specified by the address pins will appear on  $\text{I/O}_0$  to  $\text{I/O}_7$ . If Byte High Enable ( $\overline{\text{BHE}}$ ) is LOW, then data from memory will appear on  $\text{I/O}_8$  to  $\text{I/O}_{15}$ . See the truth table at the back of this data sheet for a complete description of read and write modes.

The input/output pins ( $\text{I/O}_0$  through  $\text{I/O}_{15}$ ) are placed in a high-impedance state when the device is deselected ( $\overline{\text{CE}}$  HIGH), the outputs are disabled ( $\overline{\text{OE}}$  HIGH), the  $\overline{\text{BHE}}$  and  $\overline{\text{BLE}}$  are disabled ( $\overline{\text{BHE}}$ ,  $\overline{\text{BLE}}$  HIGH), or during a write operation ( $\overline{\text{CE}}$  LOW, and  $\overline{\text{WE}}$  LOW).

The CY7C1041 is available in a standard 44-pin 400-mil-wide body width SOJ and 44-pin TSOP II package with center power and ground (revolutionary) pinout.

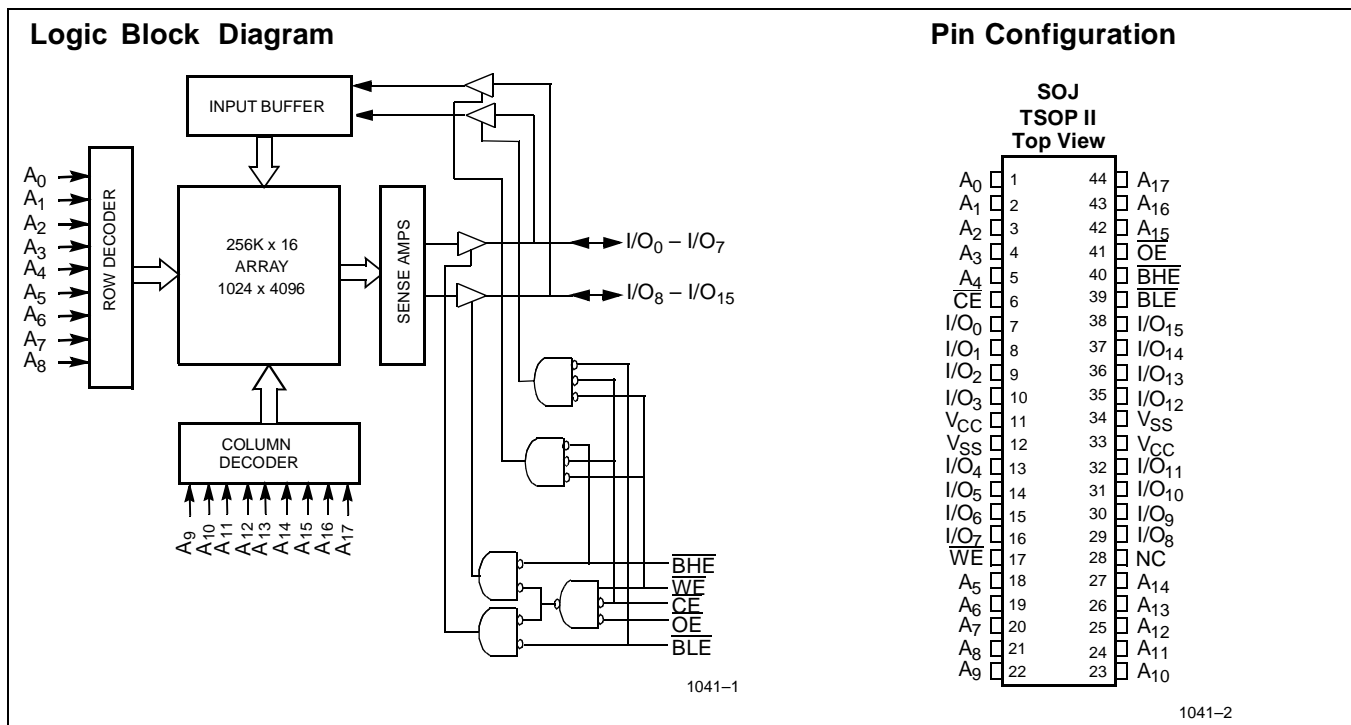

## Selection Guide

		7C1041-12	7C1041-15	7C1041-17	7C1041-20	7C1041-25
Maximum Access Time (ns)		12	15	17	20	25
Maximum Operating Current (mA)		280	260	250	230	220
Maximum CMOS Standby Current (mA)	Com'l	3	3	3	3	3
	Com'l   L	0.5	0.5	0.5	0.5	0.5
	Ind'l	6	6	6	6	6

Shaded areas contain preliminary information.

**Maximum Ratings**

(Above which the useful life may be impaired. For user guidelines, not tested.)

Storage Temperature ..... -65°C to +150°C

Ambient Temperature with Power Applied ..... -55°C to +125°C

Supply Voltage on  $V_{CC}$  to Relative GND<sup>[1]</sup> .... -0.5V to +7.0V

DC Voltage Applied to Outputs in High Z State<sup>[1]</sup> ..... -0.5V to  $V_{CC} + 0.5V$

DC Input Voltage<sup>[1]</sup> ..... -0.5V to  $V_{CC} + 0.5V$

Current into Outputs (LOW) ..... 20 mA

**Operating Range**

Range	Ambient Temperature <sup>[2]</sup>	$V_{CC}$
Commercial	0°C to +70°C	5V ± 0.5
Industrial	-40°C to +85°C	

**Electrical Characteristics** Over the Operating Range

Parameter	Description	Test Conditions	7C1041-12		7C1041-15		7C1041-17		Unit	
			Min.	Max.	Min.	Max.	Min.	Max.		
$V_{OH}$	Output HIGH Voltage	$V_{CC} = \text{Min.}, I_{OH} = -4.0 \text{ mA}$	2.4		2.4		2.4		V	
$V_{OL}$	Output LOW Voltage	$V_{CC} = \text{Min.}, I_{OL} = 8.0 \text{ mA}$		0.4		0.4		0.4	V	
$V_{IH}$	Input HIGH Voltage		2.2	$V_{CC} + 0.5$	2.2	$V_{CC} + 0.5$	2.2	$V_{CC} + 0.5$	V	
$V_{IL}$	Input LOW Voltage <sup>[1]</sup>		-0.5	0.8	-0.5	0.8	-0.5	0.8	V	
$I_{IX}$	Input Load Current	$GND \leq V_I \leq V_{CC}$	-1	+1	-1	+1	-1	+1	µA	
$I_{OZ}$	Output Leakage Current	$GND \leq V_{OUT} \leq V_{CC}$ , Output Disabled	-1	+1	-1	+1	-1	+1	µA	
$I_{CC}$	$V_{CC}$ Operating Supply Current	$V_{CC} = \text{Max.}, f = f_{MAX} = 1/t_{RC}$		280		260		250	mA	
$I_{SB1}$	Automatic CE Power-Down Current —TTL Inputs	Max. $V_{CC}$ , $\overline{CE} \geq V_{IH}$ $V_{IN} \geq V_{IH}$ or $V_{IN} \leq V_{IL}$ , $f = f_{MAX}$		40		40		40	mA	
$I_{SB2}$	Automatic CE Power-Down Current —CMOS Inputs	Max. $V_{CC}$ , $\overline{CE} \geq V_{CC} - 0.3V$ , $V_{IN} \geq V_{CC} - 0.3V$ , or $V_{IN} \leq 0.3V$ , $f = 0$	Com'l			3		3	3	mA
			Com'l	L		0.5		0.5	0.5	mA
			Ind'l			6		6	6	mA

Shaded areas contain preliminary information.

**Notes:**

- $V_{IL}$  (min.) = -2.0V for pulse durations of less than 20 ns.
- $T_A$  is the case temperature.

**Electrical Characteristics** Over the Operating Range (continued)

Parameter	Description	Test Conditions	7C1041-20		7C1041-25		Unit	
			Min.	Max.	Min.	Max.		
$V_{OH}$	Output HIGH Voltage	$V_{CC} = \text{Min.}, I_{OH} = -4.0 \text{ mA}$	2.4		2.4		V	
$V_{OL}$	Output LOW Voltage	$V_{CC} = \text{Min.}, I_{OL} = 8.0 \text{ mA}$		0.4		0.4	V	
$V_{IH}$	Input HIGH Voltage		2.2	$V_{CC} + 0.5$	2.2	$V_{CC} + 0.5$	V	
$V_{IL}$	Input LOW Voltage <sup>[1]</sup>		-0.5	0.8	-0.5	0.8	V	
$I_{IX}$	Input Load Current	$GND \leq V_I \leq V_{CC}$	-1	+1	-1	+1	$\mu\text{A}$	
$I_{OZ}$	Output Leakage Current	$GND \leq V_{OUT} \leq V_{CC}$ , Output Disabled	-1	+1	-1	+1	$\mu\text{A}$	
$I_{CC}$	$V_{CC}$ Operating Supply Current	$V_{CC} = \text{Max.},$ $f = f_{\text{MAX}} = 1/t_{RC}$		230		220	mA	
$I_{SB1}$	Automatic CE Power-Down Current —TTL Inputs	Max. $V_{CC}$ , $\overline{CE} \geq V_{IH}$ $V_{IN} \geq V_{IH}$ or $V_{IN} \leq V_{IL}$ , $f = f_{\text{MAX}}$		40		40	mA	
$I_{SB2}$	Automatic CE Power-Down Current —CMOS Inputs	Max. $V_{CC}$ , $\overline{CE} \geq V_{CC} - 0.3\text{V}$ , $V_{IN} \geq V_{CC} - 0.3\text{V}$ , or $V_{IN} \leq 0.3\text{V}$ , $f = 0$	Com'l		3		3	mA
			Com'l   L		0.5		0.5	mA
			Ind'l		6		6	mA

**Capacitance<sup>[3]</sup>**

Parameter	Description	Test Conditions	Max.	Unit
$C_{IN}$	Input Capacitance	$T_A = 25^\circ\text{C}, f = 1 \text{ MHz},$ $V_{CC} = 5.0\text{V}$	8	pF
$C_{OUT}$	I/O Capacitance		8	pF

**Note:**

3. Tested initially and after any design or process changes that may affect these parameters.

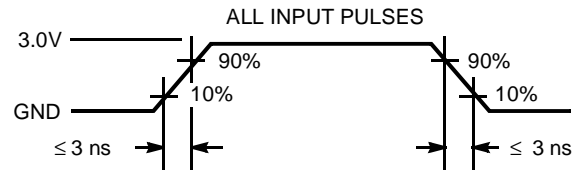
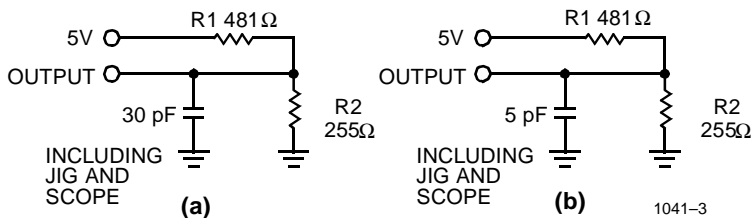
**AC Test Loads and Waveforms**

1041-4

Equivalent to: THÉVENIN EQUIVALENT

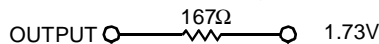

**Switching Characteristics<sup>[4]</sup> Over the Operating Range**

Parameter	Description	7C1041-12		7C1041-15		7C1041-17		Unit
		Min.	Max.	Min.	Max.	Min.	Max.	
<b>READ CYCLE</b>								
$t_{RC}$	Read Cycle Time	12		15		17		ns
$t_{AA}$	Address to Data Valid		12		15		17	ns
$t_{OHA}$	Data Hold from Address Change	3		3		3		ns
$t_{ACE}$	$\overline{CE}$ LOW to Data Valid		12		15		17	ns
$t_{DOE}$	$\overline{OE}$ LOW to Data Valid		6		7		7	ns
$t_{LZOE}$	$\overline{OE}$ LOW to Low Z	0		0		0		ns
$t_{HZOE}$	$\overline{OE}$ HIGH to High Z <sup>[5, 6]</sup>		6		7		7	ns
$t_{LZCE}$	$\overline{CE}$ LOW to Low Z <sup>[6]</sup>	3		3		3		ns
$t_{HZCE}$	$\overline{CE}$ HIGH to High Z <sup>[5, 6]</sup>		6		7		7	ns
$t_{PU}$	$\overline{CE}$ LOW to Power-Up	0		0		0		ns
$t_{PD}$	$\overline{CE}$ HIGH to Power-Down		12		15		17	ns
$t_{DBE}$	Byte Enable to Data Valid		6		7		7	ns
$t_{LZBE}$	Byte Enable to Low Z	0		0		0		ns
$t_{HZBE}$	Byte Disable to High Z		6		7		7	ns
<b>WRITE CYCLE<sup>[7, 8]</sup></b>								
$t_{WC}$	Write Cycle Time	12		15		17		ns
$t_{SCE}$	$\overline{CE}$ LOW to Write End	10		12		14		ns
$t_{AW}$	Address Set-Up to Write End	10		12		14		ns
$t_{HA}$	Address Hold from Write End	0		0		0		ns
$t_{SA}$	Address Set-Up to Write Start	0		0		0		ns
$t_{PWE}$	$\overline{WE}$ Pulse Width	10		12		14		ns
$t_{SD}$	Data Set-Up to Write End	7		8		8		ns
$t_{HD}$	Data Hold from Write End	0		0		0		ns
$t_{LZWE}$	$\overline{WE}$ HIGH to Low Z <sup>[6]</sup>	3		3		3		ns
$t_{HZWE}$	$\overline{WE}$ LOW to High Z <sup>[5, 6]</sup>		6		7		7	ns
$t_{BW}$	Byte Enable to End of Write	10		12		12		ns

Shaded areas contain preliminary information.

**Notes:**

- Test conditions assume signal transition time of 3 ns or less, timing reference levels of 1.5V, input pulse levels of 0 to 3.0V, and output loading of the specified  $I_{OL}/I_{OH}$  and 30-pF load capacitance.
- $t_{HZOE}$ ,  $t_{HZCE}$ , and  $t_{HZWE}$  are specified with a load capacitance of 5 pF as in part (b) of AC Test Loads. Transition is measured  $\pm 500$  mV from steady-state voltage.
- At any given temperature and voltage condition,  $t_{HZCE}$  is less than  $t_{LZCE}$ ,  $t_{HZOE}$  is less than  $t_{LZOE}$ , and  $t_{HZWE}$  is less than  $t_{LZWE}$  for any given device.
- The internal write time of the memory is defined by the overlap of  $\overline{CE}$  LOW, and  $\overline{WE}$  LOW.  $\overline{CE}$  and  $\overline{WE}$  must be LOW to initiate a write, and the transition of either of these signals can terminate the write. The input data set-up and hold timing should be referenced to the leading edge of the signal that terminates the write.
- The minimum write cycle time for Write Cycle No. 3 (WE controlled, OE LOW) is the sum of  $t_{HZWE}$  and  $t_{SD}$ .

**Switching Characteristics<sup>[4]</sup>** Over the Operating Range (continued)

Parameter	Description	7C1041-20		7C1041-25		Unit
		Min.	Max.	Min.	Max.	
<b>READ CYCLE</b>						
t <sub>RC</sub>	Read Cycle Time	20		25		ns
t <sub>AA</sub>	Address to Data Valid		20		25	ns
t <sub>OHA</sub>	Data Hold from Address Change	3		5		ns
t <sub>ACE</sub>	$\overline{CE}$ LOW to Data Valid		20		25	ns
t <sub>DOE</sub>	$\overline{OE}$ LOW to Data Valid		8		10	ns
t <sub>LZOE</sub>	$\overline{OE}$ LOW to Low Z	0		0		ns
t <sub>HZOE</sub>	$\overline{OE}$ HIGH to High Z <sup>[5, 6]</sup>		8		10	ns
t <sub>LZCE</sub>	$\overline{CE}$ LOW to Low Z <sup>[6]</sup>	3		5		ns
t <sub>HZCE</sub>	$\overline{CE}$ HIGH to High Z <sup>[5, 6]</sup>		8		10	ns
t <sub>PU</sub>	$\overline{CE}$ LOW to Power-Up	0		0		ns
t <sub>PD</sub>	$\overline{CE}$ HIGH to Power-Down		20		25	ns
t <sub>DBE</sub>	Byte Enable to Data Valid		8		10	ns
t <sub>LZBE</sub>	Byte Enable to Low Z	0		0		ns
t <sub>HZBE</sub>	Byte Disable to High Z		8		10	ns
<b>WRITE CYCLE<sup>[7, 8]</sup></b>						
t <sub>WC</sub>	Write Cycle Time	20		25		ns
t <sub>SCE</sub>	$\overline{CE}$ LOW to Write End	13		15		ns
t <sub>AW</sub>	Address Set-Up to Write End	13		15		ns
t <sub>HA</sub>	Address Hold from Write End	0		0		ns
t <sub>SA</sub>	Address Set-Up to Write Start	0		0		ns
t <sub>PWE</sub>	$\overline{WE}$ Pulse Width	13		15		ns
t <sub>SD</sub>	Data Set-Up to Write End	9		10		ns
t <sub>HD</sub>	Data Hold from Write End	0		0		ns
t <sub>LZWE</sub>	$\overline{WE}$ HIGH to Low Z <sup>[6]</sup>	3		5		ns
t <sub>HZWE</sub>	$\overline{WE}$ LOW to High Z <sup>[5, 6]</sup>		8		10	ns
t <sub>BW</sub>	Byte Enable to End of Write	13		15		ns

**Data Retention Characteristics** Over the Operating Range

Parameter	Description	Conditions <sup>[10]</sup>	Min.	Max.	Unit	
V <sub>DR</sub>	V <sub>CC</sub> for Data Retention		2.0		V	
I <sub>CCDR</sub>	Data Retention Current	V <sub>CC</sub> = V <sub>DR</sub> = 2.0V, CE ≥ V <sub>CC</sub> - 0.3V, V <sub>IN</sub> ≥ V <sub>CC</sub> - 0.3V or V <sub>IN</sub> ≤ 0.3V			μA	
			Com'l L		200	μA
					μA	
t <sub>CDR</sub> <sup>[3]</sup>	Chip Deselect to Data Retention Time		0		ns	
t <sub>R</sub> <sup>[9]</sup>	Operation Recovery Time		See Note 9			

**Notes:**

9. t<sub>r</sub> ≤ 100 μs for all speeds.
10. No input may exceed V<sub>CC</sub> + 0.5V.

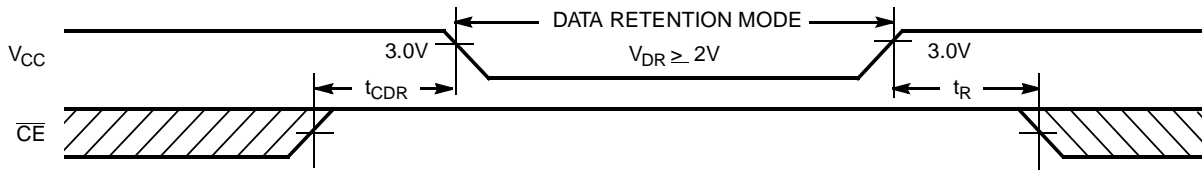
**Data Retention Waveform**

1041-5

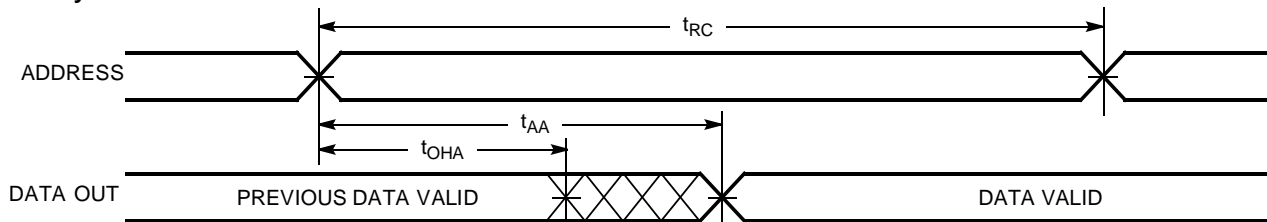
**Switching Waveforms**
**Read Cycle No.1** <sup>[11, 12]</sup>

1041-6

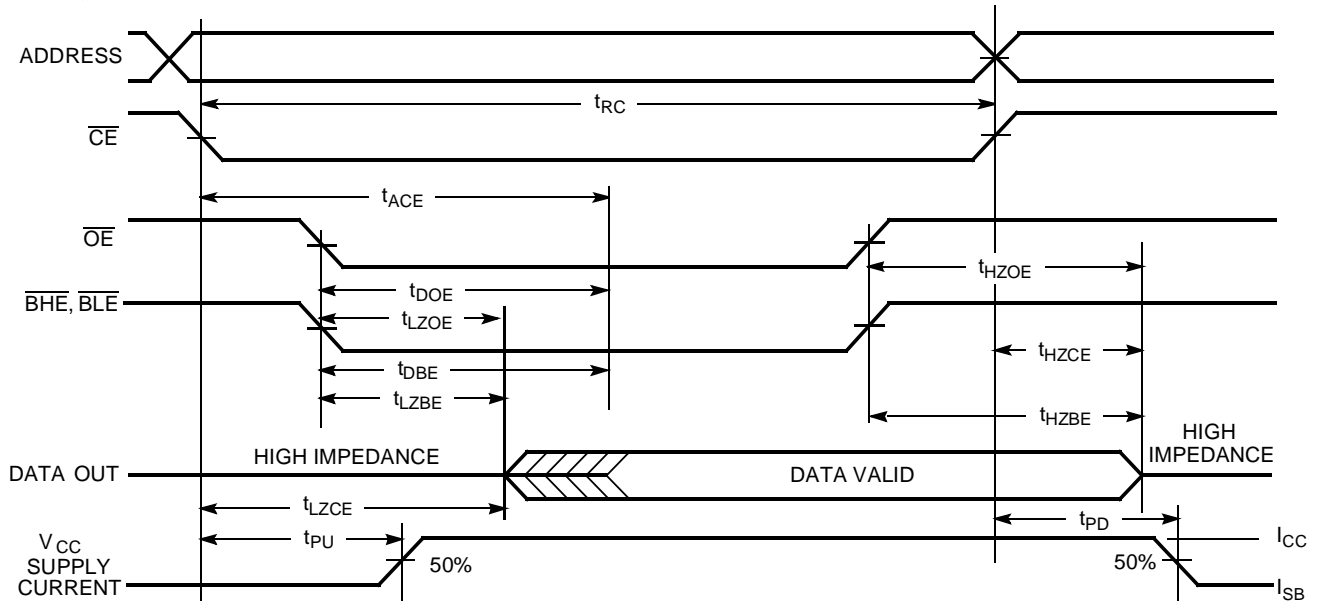
**Read Cycle No.2 ( $\overline{OE}$  Controlled)** <sup>[12, 13]</sup>

1041-7

**Notes:**

11. Device is continuously selected.  $\overline{OE}$ ,  $\overline{CE}$ ,  $\overline{BHE}$ , and/or  $\overline{BLE}$  =  $V_{IL}$ .
12.  $\overline{WE}$  is HIGH for read cycle.
13. Address valid prior to or coincident with  $\overline{CE}$  transition LOW.

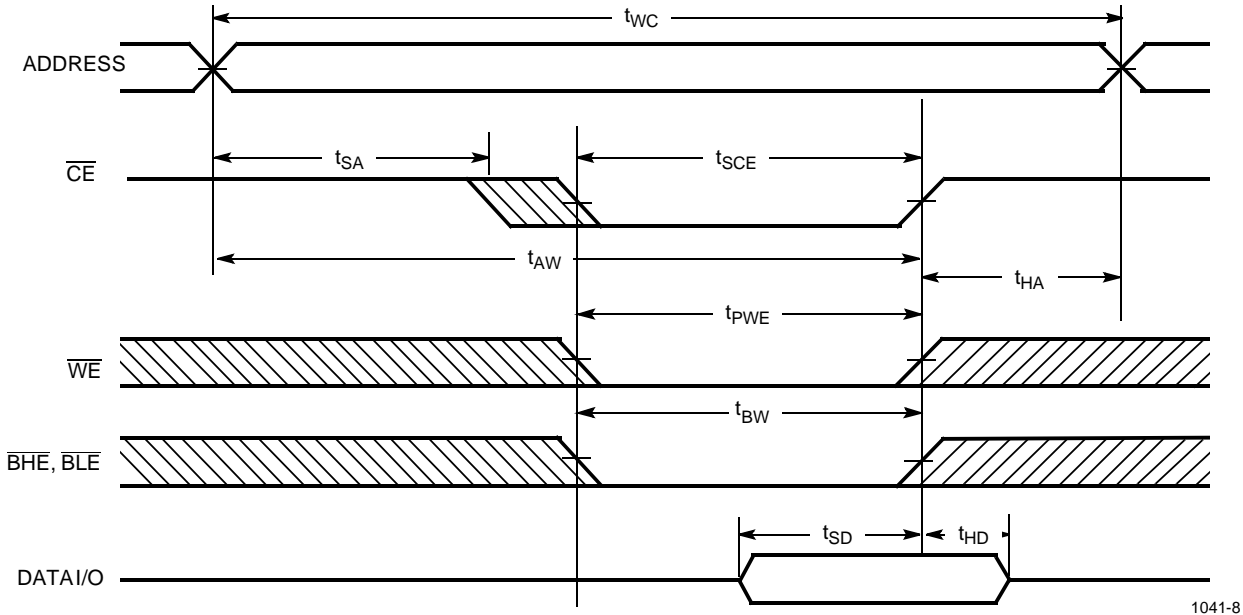
**Switching Waveforms (continued)**
**Write Cycle No. 1 ( $\overline{CE}$  Controlled)** <sup>[14, 15]</sup>

1041-8

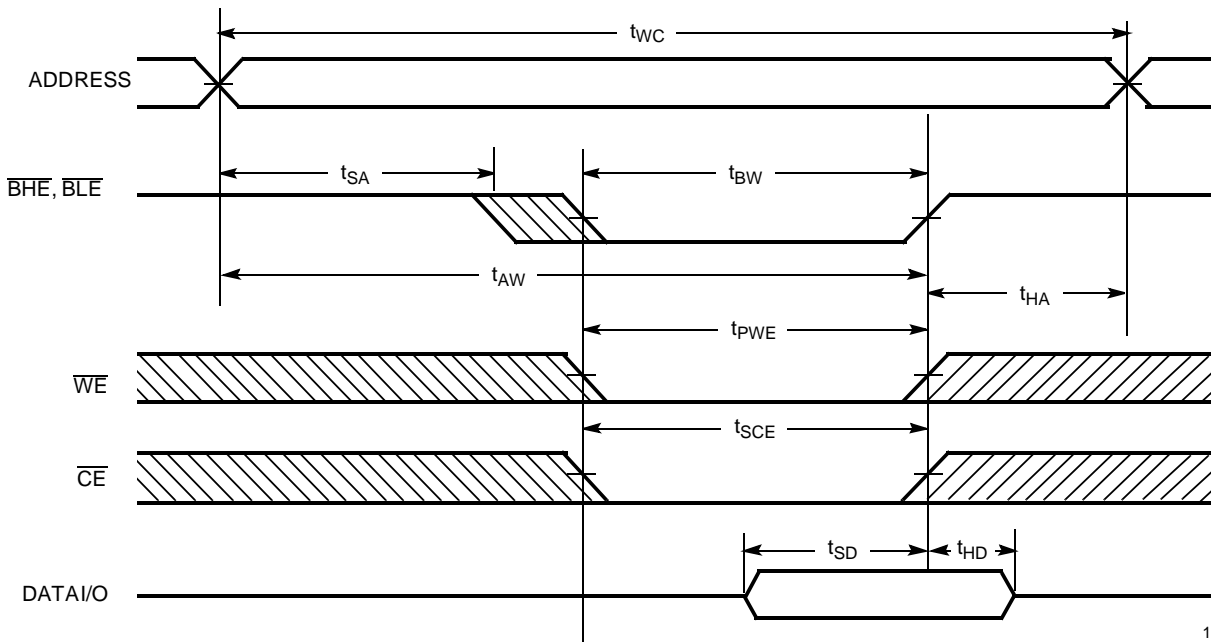
**Write Cycle No. 2 ( $\overline{BLE}$  or  $\overline{BHE}$  Controlled)**

1041-9

**Notes:**

14. Data I/O is high impedance if  $\overline{OE}$  or  $\overline{BHE}$  and/or  $\overline{BLE} = V_{IH}$ .
15. If  $\overline{CE}$  goes HIGH simultaneously with  $\overline{WE}$  going HIGH, the output remains in a high-impedance state.

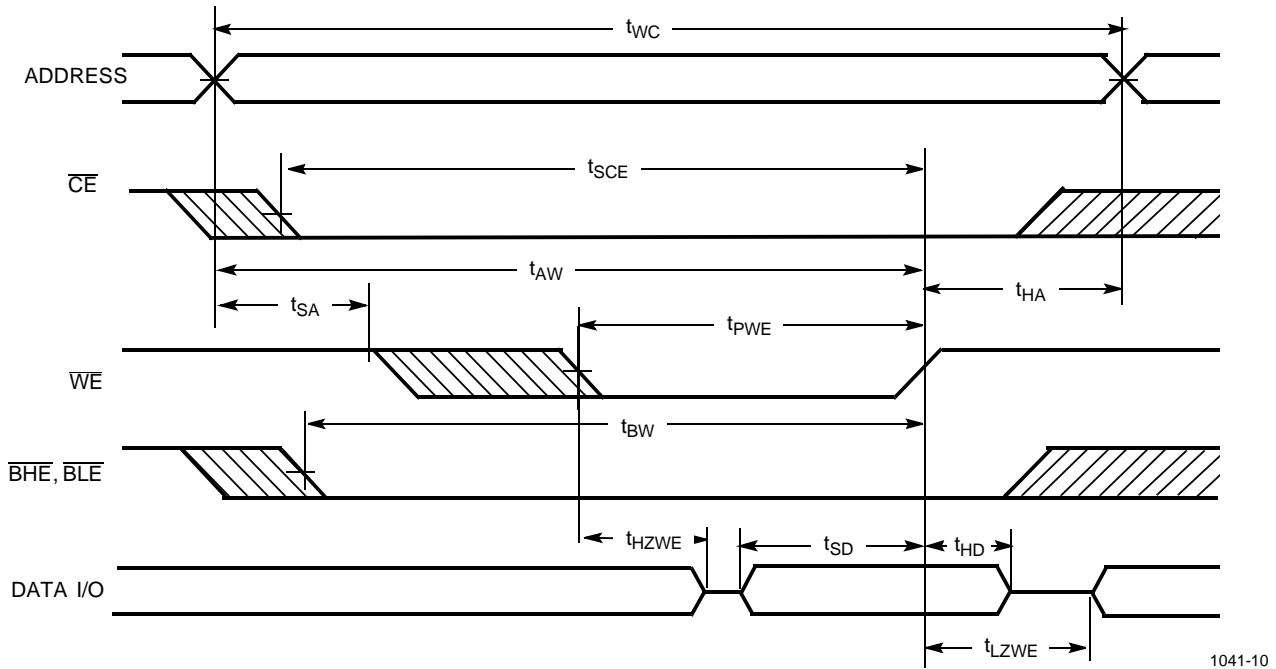
**Switching Waveforms (continued)**
**Write Cycle No.3 ( $\overline{WE}$  Controlled, LOW)**

1041-10

**Truth Table**

$\overline{CE}$	$\overline{OE}$	$\overline{WE}$	$\overline{BLE}$	$\overline{BHE}$	$I/O_0-I/O_7$	$I/O_8-I/O_{15}$	Mode	Power
H	X	X	X	X	High Z	High Z	Power Down	Standby ( $I_{SB}$ )
L	L	H	L	L	Data Out	Data Out	Read All Bits	Active ( $I_{CC}$ )
L	L	H	L	H	Data Out	High Z	Read Lower Bits Only	Active ( $I_{CC}$ )
L	L	H	H	L	High Z	Data Out	Read Upper Bits Only	Active ( $I_{CC}$ )
L	X	L	L	L	Data In	Data In	Write All Bits	Active ( $I_{CC}$ )
L	X	L	L	H	Data In	High Z	Write Lower Bits Only	Active ( $I_{CC}$ )
L	X	L	H	L	High Z	Data In	Write Upper Bits Only	Active ( $I_{CC}$ )
L	H	H	X	X	High Z	High Z	Selected, Outputs Disabled	Active ( $I_{CC}$ )



**Ordering Information**

Speed (ns)	Ordering Code	Package Name	Package Type	Operating Range
15	CY7C1041-15VC	V34	44-Lead (400-Mil) Molded SOJ	Commercial
	CY7C1041L-15VC	V34	44-Lead (400-Mil) Molded SOJ	
	CY7C1041-15ZC	Z44	44-Lead TSOP Type II	
	CY7C1041L-15ZC	Z44	44-Lead TSOP Type II	
17	CY7C1041-17VC	V34	44-Lead (400-Mil) Molded SOJ	
	CY7C1041L-17VC	V34	44-Lead (400-Mil) Molded SOJ	
	CY7C1041-17ZC	Z44	44-Lead TSOP Type II	
	CY7C1041L-17ZC	Z44	44-Lead TSOP Type II	
20	CY7C1041-20VC	V34	44-Lead (400-Mil) Molded SOJ	
	CY7C1041L-20VC	V34	44-Lead (400-Mil) Molded SOJ	
	CY7C1041-20ZC	Z44	44-Lead TSOP Type II	
	CY7C1041L-20ZC	Z44	44-Lead TSOP Type II	
25	CY7C1041-25VC	V34	44-Lead (400-Mil) Molded SOJ	
	CY7C1041L-25VC	V34	44-Lead (400-Mil) Molded SOJ	
	CY7C1041-25ZC	Z44	44-Lead TSOP Type II	
	CY7C1041L-25ZC	Z44	44-Lead TSOP Type II	
15	CY7C1041-15ZI	Z44	44-Lead TSOP Type II	Industrial
	CY7C1041-15VI	V34	44-Lead (400-Mil) Molded SOJ	
17	CY7C1041-17ZI	V34	44-Lead TSOP Type II	
	CY7C1041-17VI	Z44	44-Lead (400-Mil) Molded SOJ	
20	CY7C1041-20ZI	Z44	44-Lead TSOP Type II	
	CY7C1041-20VI	Z44	44-Lead (400-Mil) Molded SOJ	
25	CY7C1041-25ZI	Z44	44-Lead TSOP Type II	
	CY7C1041-25VI	Z44	44-Lead (400-Mil) Molded SOJ	

Document #: 38-00644-B

Package Diagrams

44-Lead (400-Mil) Molded SOJ V34

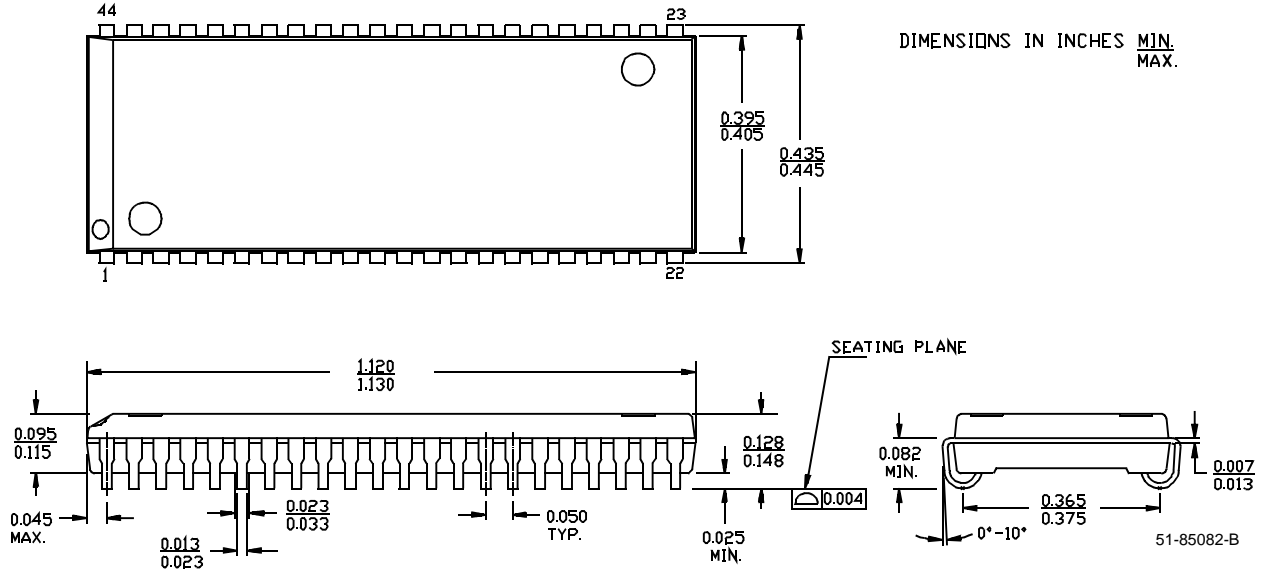

44-Pin TSOP II Z44

DIMENSION IN MM (INCH)  
MAX  
MIN.

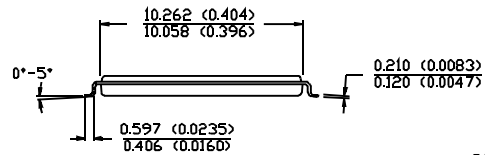
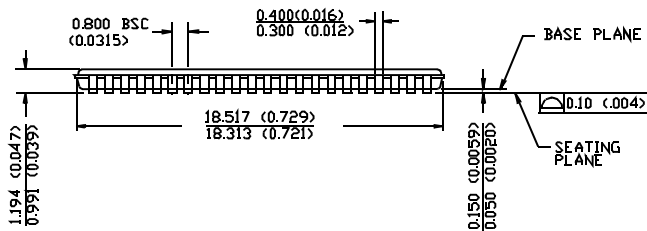
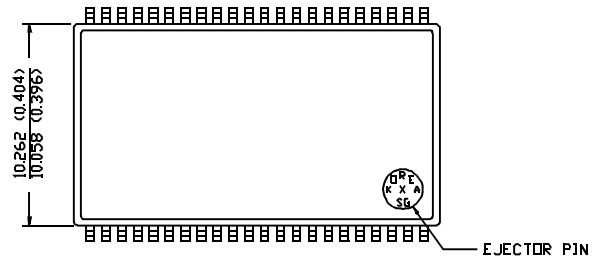
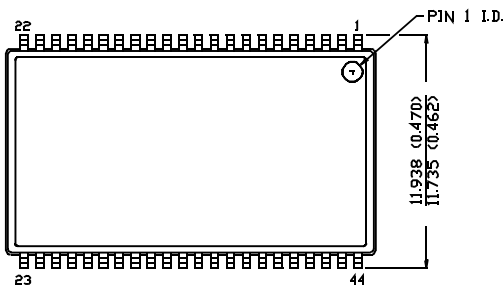

51-85087-A