

## DUAL OPERATIONAL AMPLIFIER

- In the Linear Mode the Input Common Mode Voltage Range Includes Ground.
- Two Internally Compensated OP Amps are in Single Package.
- Low Power Dissipation and Power Drain Suitable for Battery Operation.
- Differential Input Voltage Range Equal to the Power Supply Voltage.
- Wide Power Supply Voltage Range and Signal Power Supply  
: Single Supply  $3V_{DC}$  to  $36V_{DC}$  Dual Supplies  $\pm 1.5V_{DC}$  to  $\pm 18V_{DC}$
- Large Output Voltage Swing :  $0V_{DC}$  to  $V_{CC}-1.5V_{DC}$
- Low Input Biasing Current :  $I_I=45nA_{DC}$  (Typ.)
- Possible to Exchange the Position of Pin⑨ for Pin① Because of Pin Connection Being Symmetric. (KIA358S only)
- The Pin① and Pin⑨ of Lead Frame was Each Other Connected. (KIA358S Only)

## PIN CONNECTION (TOP VIEW)

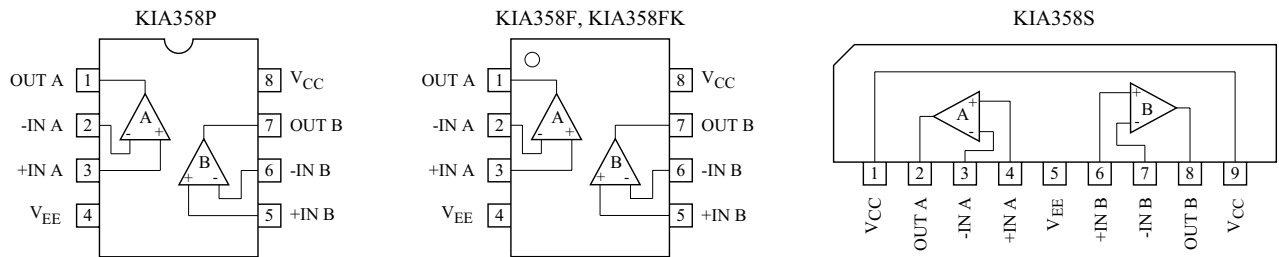

## MARKING

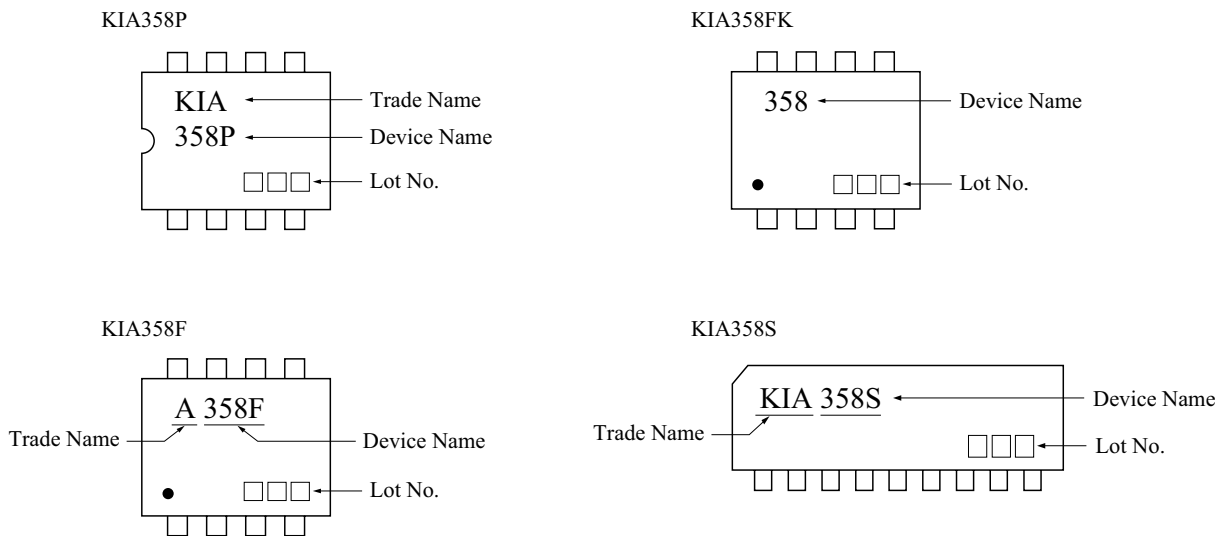

# KIA358P/S/F/FK

## EQUIVALENT CIRCUIT

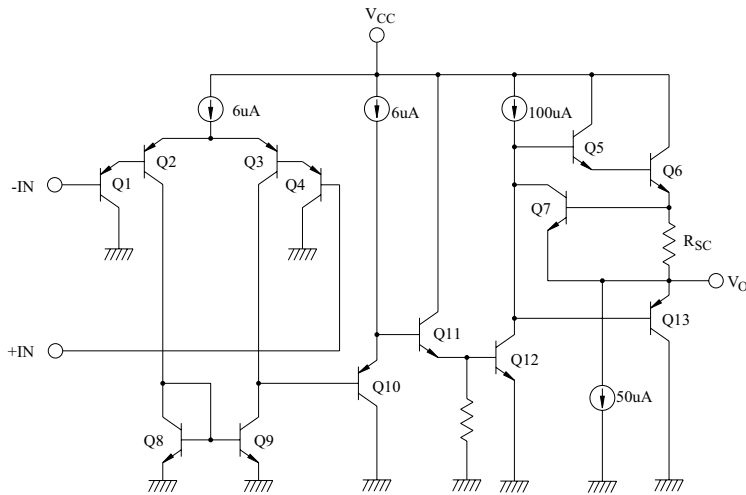

## MAXIMUM RATINGS (Ta=25 °C)

CHARACTERISTIC		SYMBOL	RATING	UNIT	
Supply Voltage		$V_{CC}$	36, +18	V	
		$V_{EE}$	0, -18		
Differential Input Voltage		$DV_{IN}$	$\pm 36$	V	
Input Voltage		$V_{IN}$	-0.3 ~ 36	V	
Power Dissipation	KIA358P/S	$P_D$	500	mW	
	KIA358F		280		
	KIA358FK		200		
Operating Temperature		$T_{opr}$	-40 ~ 85	°C	
Storage Temperature		$T_{stg}$	-55 ~ 125	°C	
Pin ① to Pin ⑨ Maximum Current		KIA358S	$I_{max}$	1	A

## ELECTRICAL CHARACTERISTICS ( $V_{CC}=5V$ , $V_{EE}=GND$ , $T_a=25^\circ C$ )

CHARACTERISTIC	SYMBOL	TEST CONDITION	MIN.	TYP.	MAX.	UNIT
Input Offset Voltage	$V_{IO}$	$R_g \leq 10k \Omega$	-	2	7	mV
Input Offset Current	$I_{IO}$	-	-	5	30	nA
Input Bias Current	$I_I$	-	-	45	150	nA
Common Mode Input Voltage	$CMV_{IN}$	$V_{CC}=30V$ , $V_{EE}=GND$	0	-	$V_{CC}-1.5$	V
Supply Current	$I_{CC}$ , $I_{EE}$	$R_L = \infty$ , All OP Amps	-	0.7	1.2	mA
Voltage Gain	$G_V$	$R_L \geq 2k \Omega$	86	100	-	dB
Maximum Output Voltage Swing	$V_{OP-P}$	$R_L = 2k \Omega$	0	$V_{CC}-1.5$	-	V
Common Mode Input Signal Rejection Ratio	CMRR	-	60	85	-	dB
Supply Voltage Rejection Ratio	SVRR	$R_g = 10k \Omega$	60	100	-	dB
Source Current	$I_{source}$	-IN=0V <sub>DC</sub> , +IN=1V <sub>DC</sub>	20	40	-	mA
Sink Current	$I_{sink}$	-IN=1V <sub>DC</sub> , +IN=0V <sub>DC</sub>	10	20	-	mA

# KIA358P/S/F/FK

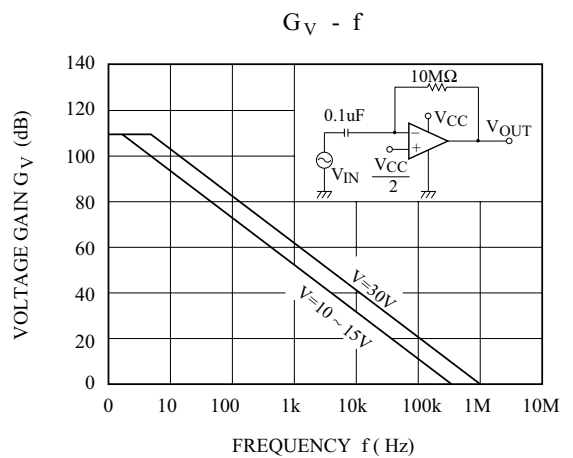
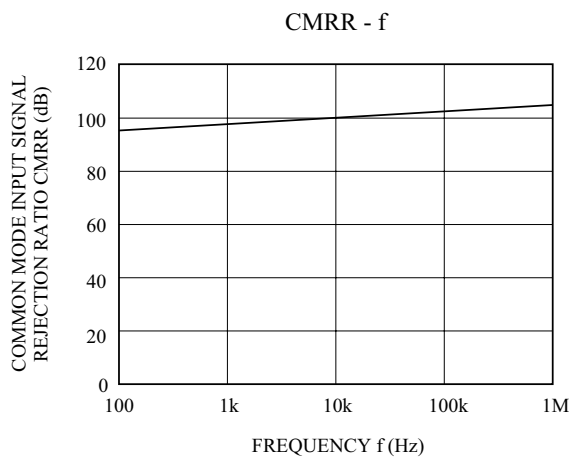
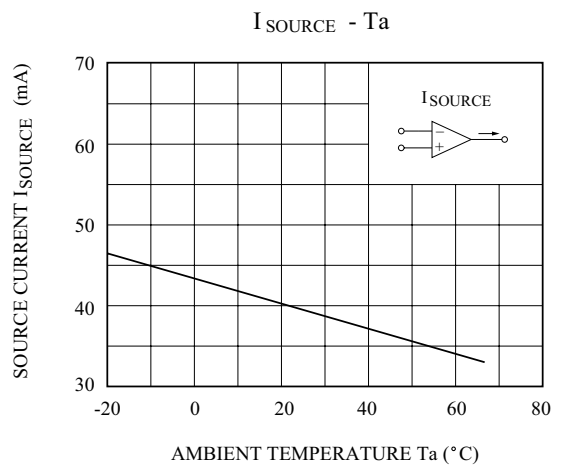
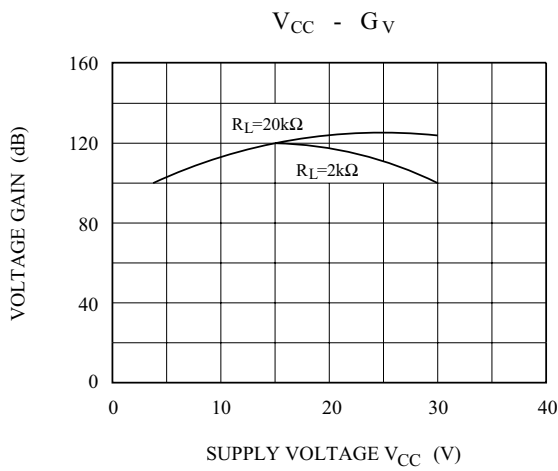
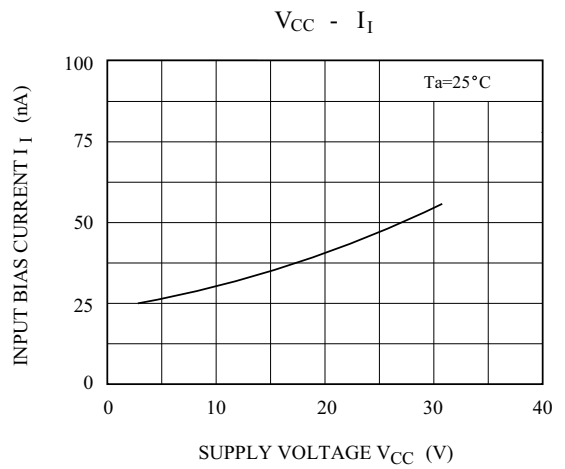
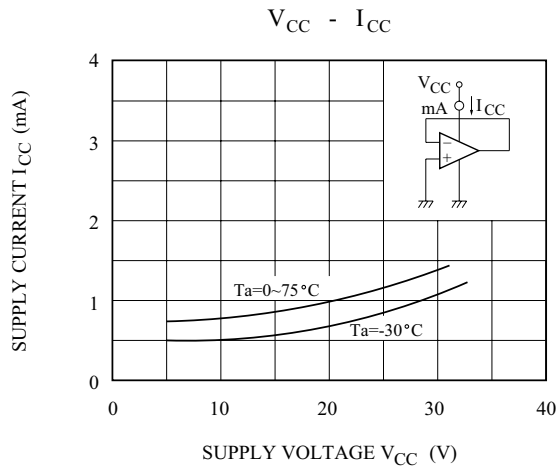

# KIA358P/S/F/FK

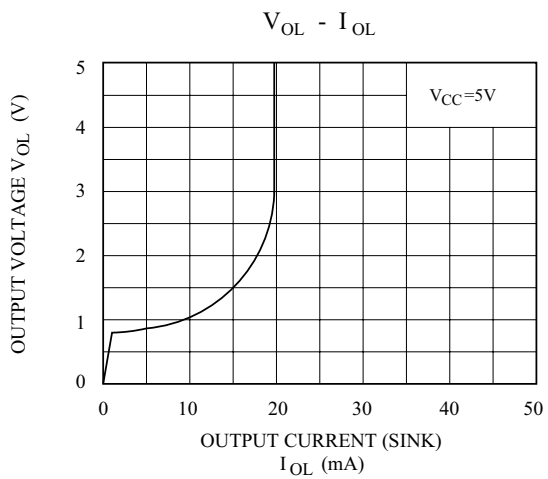
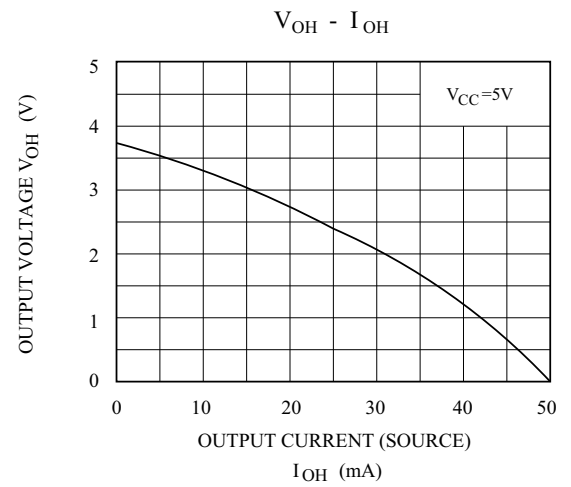
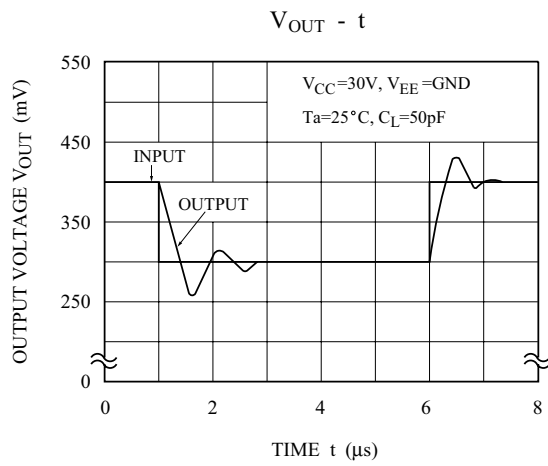
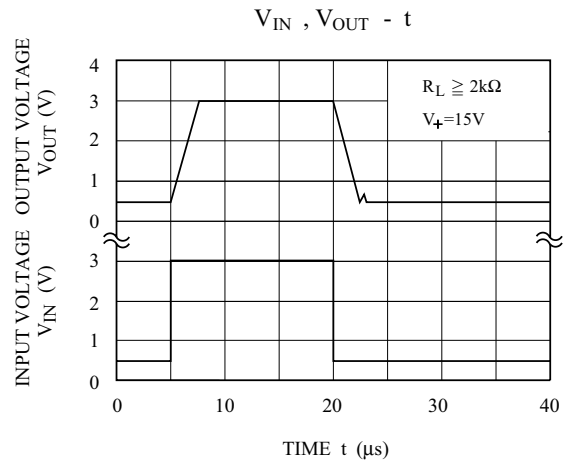
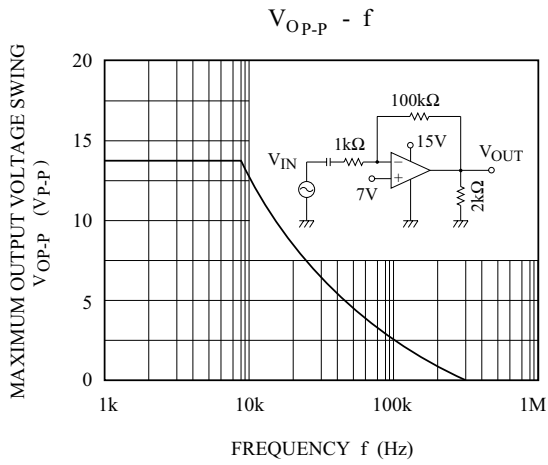

# KIA358P/S/F/FK

