

# 1-Mbit (64K x 16) Static RAM

## Features

- **Very high speed**
  - 55 ns
- **Temperature Ranges**
  - Industrial: -40°C to 85°C
  - Automotive: -40°C to 125°C
- **Wide voltage range**
  - 2.2V - 3.6V
- **Pin compatible with CY62126BV**
- **Ultra-low active power**
  - Typical active current: 0.85 mA @ f = 1 MHz
  - Typical active current: 5 mA @ f = f<sub>Max</sub> (55 ns speed)
- **Ultra-low standby power**
- **Easy memory expansion with  $\overline{\text{CE}}$  and  $\overline{\text{OE}}$  features**
- **Automatic power-down when deselected**
- **Available in Pb-free and non Pb-free 48-ball VFBGA and 44-pin TSOP Type II packages**

## Functional Description<sup>[1]</sup>

The CY62126DV30 is a high-performance CMOS static RAM organized as 64K words by 16 bits. This device features

advanced circuit design to provide ultra-low active current. This is ideal for providing More Battery Life™ (MoBL®) in portable applications such as cellular telephones. The device also has an automatic power-down feature that significantly reduces power consumption by 90% when addresses are not toggling. The device can be put into standby mode reducing power consumption by more than 99% when deselected ( $\overline{\text{CE}}$  HIGH). The input/output pins (I/O<sub>0</sub> through I/O<sub>15</sub>) are placed in a high-impedance state when: deselected ( $\overline{\text{CE}}$  HIGH), outputs are disabled ( $\overline{\text{OE}}$  HIGH), both Byte High Enable and Byte Low Enable are disabled ( $\overline{\text{BHE}}$ , BLE HIGH) or during a write operation ( $\overline{\text{CE}}$  LOW and  $\overline{\text{WE}}$  LOW).

Writing to the device is accomplished by taking Chip Enable ( $\overline{\text{CE}}$ ) and Write Enable ( $\overline{\text{WE}}$ ) inputs LOW. If Byte Low Enable (BLE) is LOW, then data from I/O pins (I/O<sub>0</sub> through I/O<sub>7</sub>), is written into the location specified on the address pins (A<sub>0</sub> through A<sub>15</sub>). If Byte High Enable (BHE) is LOW, then data from I/O pins (I/O<sub>8</sub> through I/O<sub>15</sub>) is written into the location specified on the address pins (A<sub>0</sub> through A<sub>15</sub>).

Reading from the device is accomplished by taking Chip Enable ( $\overline{\text{CE}}$ ) and Output Enable ( $\overline{\text{OE}}$ ) LOW while forcing the Write Enable ( $\overline{\text{WE}}$ ) HIGH. If Byte Low Enable (BLE) is LOW, then data from the memory location specified by the address pins will appear on I/O<sub>0</sub> to I/O<sub>7</sub>. If Byte High Enable (BHE) is LOW, then data from memory will appear on I/O<sub>8</sub> to I/O<sub>15</sub>. See the truth table at the back of this data sheet for a complete description of read and write modes.

## Logic Block Diagram

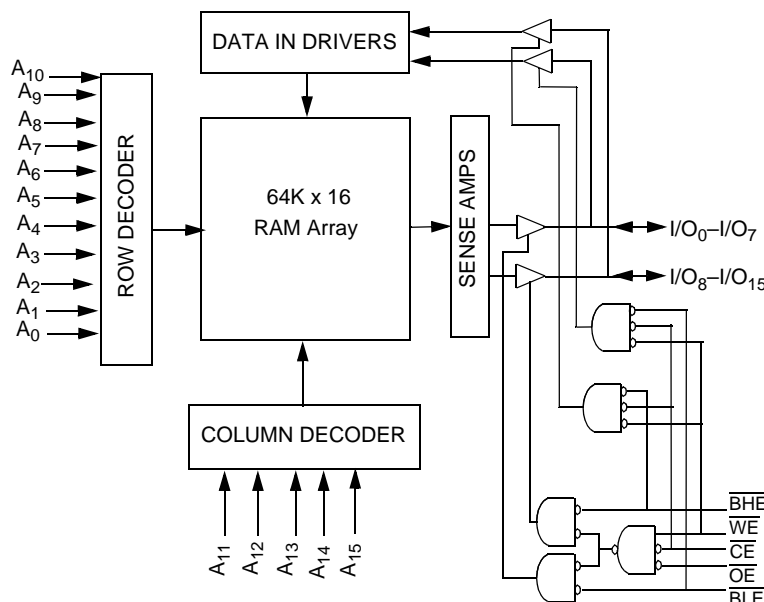

### Note:

1. For best-practice recommendations, please refer to the Cypress application note "System Design Guidelines" on <http://www.cypress.com>.

**Product Portfolio**

Product	Range	V <sub>CC</sub> Range (V)			Speed (ns)	Power Dissipation					
						Operating, I <sub>CC</sub> (mA)				Standby, I <sub>SB2</sub> (μA)	
		f = 1 MHz		f = f <sub>Max</sub>							
		Min.	Typ.	Max.		Typ. <sup>[2]</sup>	Max.	Typ. <sup>[2]</sup>	Max.	Typ. <sup>[2]</sup>	Max.
CY62126DV30L	Automotive	2.2	3.0	3.6	55	0.85	1.5	5	10	1.5	15
CY62126DV30LL	Industrial				55	0.85	1.5	5	10	1.5	4

**Pin Configurations<sup>[3, 4]</sup>**

**48-ball VFBGA  
Top View**

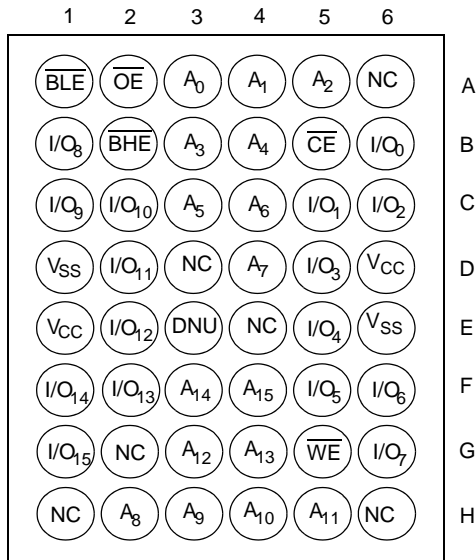

**TSOP II (Forward)  
Top View**

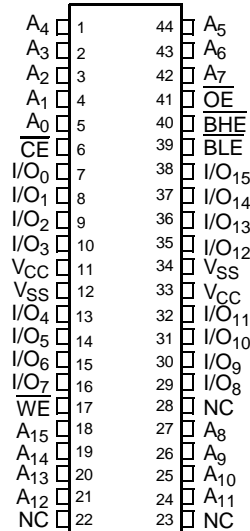

**Notes:**

- Typical values are included for reference only and are not guaranteed or tested. Typical values are measured at V<sub>CC</sub> = V<sub>CC(typ)</sub>, T<sub>A</sub> = 25°C.
- NC pins are not connected to the die.
- E3 (DNU) can be left as NC or V<sub>SS</sub> to ensure proper operation. (Expansion Pins on FBGA Package: E4 - 2M, D3 - 4M, H1 - 8M, G2 - 16M, H6 - 32M).

**Maximum Ratings**

(Above which the useful life may be impaired. For user guidelines, not tested.)

Storage Temperature .....	-65°C to +150°C
Ambient Temperature with Power Applied.....	-55°C to +125°C
Supply Voltage to Ground Potential .....	-0.3 to 3.9V
DC Voltage Applied to Outputs in High-Z State <sup>[6]</sup> .....	-0.3V to V <sub>CC</sub> + 0.3V

DC Input Voltage <sup>[6]</sup> .....	-0.3V to V <sub>CC</sub> + 0.3V
Output Current into Outputs (LOW).....	20 mA
Static Discharge Voltage.....	> 2001V (per MIL-STD-883, Method 3015)
Latch-up Current .....	> 200 mA

**Operating Range**

Range	Ambient Temperature (T <sub>A</sub> )	V <sub>CC</sub> <sup>[7]</sup>
Industrial	-40°C to +85°C	2.2V to 3.6V
Automotive	-40°C to +125°C	2.2V to 3.6V

**DC Electrical Characteristics (Over the Operating Range)**

Parameter	Description	Test Conditions		CY62126DV30-55			Unit	
				Min.	Typ. <sup>[5]</sup>	Max.		
V <sub>OH</sub>	Output HIGH Voltage	2.2V ≤ V <sub>CC</sub> ≤ 2.7V	I <sub>OH</sub> = -0.1 mA	2.0			V	
		2.7V ≤ V <sub>CC</sub> ≤ 3.6V	I <sub>OH</sub> = -1.0 mA	2.4				
V <sub>OL</sub>	Output LOW Voltage	2.2V ≤ V <sub>CC</sub> ≤ 2.7V	I <sub>OL</sub> = 0.1 mA			0.4	V	
		2.7V ≤ V <sub>CC</sub> ≤ 3.6V	I <sub>OL</sub> = 2.1 mA			0.4		
V <sub>IH</sub>	Input HIGH Voltage	2.2V ≤ V <sub>CC</sub> ≤ 2.7V		1.8		V <sub>CC</sub> + 0.3	V	
		2.7V ≤ V <sub>CC</sub> ≤ 3.6V		2.2		V <sub>CC</sub> + 0.3		
V <sub>IL</sub>	Input LOW Voltage	2.2V ≤ V <sub>CC</sub> ≤ 2.7V		-0.3		0.6	V	
		2.7V ≤ V <sub>CC</sub> ≤ 3.6V		-0.3		0.8		
I <sub>IX</sub>	Input Leakage Current	GND ≤ V <sub>I</sub> ≤ V <sub>CC</sub>		Ind'l	-1	+1	μA	
				Auto	-4	+4		
I <sub>OZ</sub>	Output Leakage Current	GND ≤ V <sub>O</sub> ≤ V <sub>CC</sub> , Output Disabled		Ind'l	-1	+1	μA	
				Auto	-4	+4		
I <sub>CC</sub>	V <sub>CC</sub> Operating Supply Current	f = f <sub>Max</sub> = 1/t <sub>RC</sub>	V <sub>CC</sub> = 3.6V, I <sub>OUT</sub> = 0 mA, CMOS level		5	10	mA	
		f = 1 MHz			0.85	1.5		
I <sub>SB1</sub>	Automatic CE Power-down Current—CMOS Inputs	$\overline{CE} \geq V_{CC} - 0.2V,$ $V_{IN} \geq V_{CC} - 0.2V,$ $V_{IN} \leq 0.2V,$ $f = f_{Max}$ (Address and Data Only), $f = 0$ ( $\overline{OE}$ , $\overline{WE}$ , $\overline{BHE}$ and $\overline{BLE}$ )	L	Ind'l		1.5	5	μA
				Auto		1.5	15	
			LL			1.5	4	
I <sub>SB2</sub>	Automatic CE Power-down Current—CMOS Inputs	$\overline{CE} \geq V_{CC} - 0.2V,$ $V_{IN} \geq V_{CC} - 0.2V$ or $V_{IN} \leq 0.2V, f = 0, V_{CC} = 3.6V$	L	Ind'l		1.5	5	μA
				Auto		1.5	15	
			LL			1.5	4	

**Notes:**

- Typical values are included for reference only and are not guaranteed or tested. Typical values are measured at V<sub>CC</sub> = V<sub>CC(typ)</sub>, T<sub>A</sub> = 25°C.
- V<sub>IL(min.)</sub> = -2.0V for pulse durations less than 20 ns., V<sub>IH(max.)</sub> = V<sub>CC</sub> + 0.75V for pulse durations less than 20 ns.
- Full device operation requires linear ramp of V<sub>CC</sub> from 0V to V<sub>CC(min)</sub> & V<sub>CC</sub> must be stable at V<sub>CC(min)</sub> for 500 μs.

**Capacitance<sup>[8]</sup>**

Parameter	Description	Test Conditions	Max.	Unit
C <sub>IN</sub>	Input Capacitance	T <sub>A</sub> = 25°C, f = 1 MHz, V <sub>CC</sub> = V <sub>CC(typ)</sub>	8	pF
C <sub>OUT</sub>	Output Capacitance		8	pF

**Thermal Resistance<sup>[8]</sup>**

Parameter	Description	Test Conditions	TSOP	VFBGA	Unit
Θ <sub>JA</sub>	Thermal Resistance (Junction to Ambient)	Still Air, soldered on a 3 x 4.5 inch, 2-layer printed circuit board	55	76	°C/W
Θ <sub>JC</sub>	Thermal Resistance (Junction to Case)		12	11	°C/W

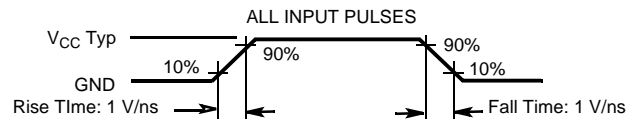
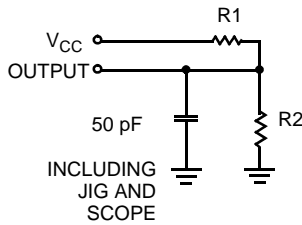
**AC Test Loads and Waveforms**

Equivalent to: THEVENIN EQUIVALENT

Parameters	2.5V	3.0V	Unit
R <sub>1</sub>	16600	1103	Ohms
R <sub>2</sub>	15400	1554	Ohms
R <sub>TH</sub>	8000	645	Ohms
V <sub>TH</sub>	1.2	1.75	Volts

**Data Retention Characteristics**

Parameter	Description	Conditions	Min.	Typ <sup>[2]</sup>	Max.	Unit
V <sub>DR</sub>	V <sub>CC</sub> for Data Retention		1.5			V
I <sub>CCDR</sub>	Data Retention Current	V <sub>CC</sub> =1.5V, $\overline{CE} \geq V_{CC} - 0.2V$ , V <sub>IN</sub> ≥ V <sub>CC</sub> - 0.2V or V <sub>IN</sub> ≤ 0.2V	L	Ind'l	4	μA
			L	Auto	10	
			LL	Ind'l	3	
t <sub>CDR</sub> <sup>[8]</sup>	Chip Deselect to Data Retention Time		0			ns
t <sub>R</sub> <sup>[9]</sup>	Operation Recovery Time		100			μs

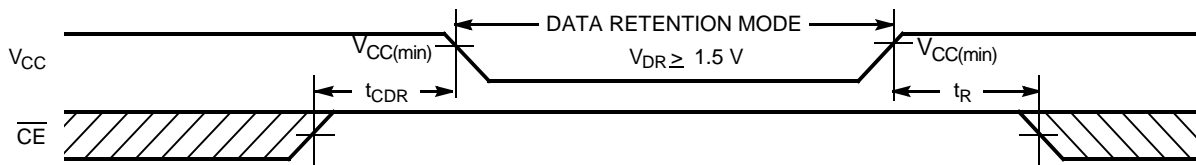
**Data Retention Waveform**

**Notes:**

8. Tested initially and after any design or process changes that may affect these parameters.
9. Full device operation requires linear V<sub>CC</sub> ramp from V<sub>DR</sub> to V<sub>CC(min.)</sub> >100 μs.

**Switching Characteristics (Over the Operating Range)<sup>[10]</sup>**

Parameter	Description	CY62126DV30-55		Unit
		Min.	Max.	
<b>Read Cycle</b>				
t <sub>RC</sub>	Read Cycle Time	55		ns
t <sub>AA</sub>	Address to Data Valid		55	ns
t <sub>OHA</sub>	Data Hold from Address Change	10		ns
t <sub>ACE</sub>	$\overline{CE}$ LOW to Data Valid		55	ns
t <sub>DOE</sub>	$\overline{OE}$ LOW to Data Valid		25	ns
t <sub>LZOE</sub>	$\overline{OE}$ LOW to Low Z <sup>[11]</sup>	5		ns
t <sub>HZOE</sub>	$\overline{OE}$ HIGH to High Z <sup>[11, 12]</sup>		20	ns
t <sub>LZCE</sub>	$\overline{CE}$ LOW to Low Z <sup>[11]</sup>	10		ns
t <sub>HZCE</sub>	$\overline{CE}$ HIGH to High Z <sup>[11, 12]</sup>		20	ns
t <sub>PU</sub>	$\overline{CE}$ LOW to Power-up	0		ns
t <sub>PD</sub>	$\overline{CE}$ HIGH to Power-down		55	ns
t <sub>DBE</sub>	$\overline{BLE}/\overline{BHE}$ LOW to Data Valid		25	ns
t <sub>LZBE</sub>	$\overline{BLE}/\overline{BHE}$ LOW to Low Z <sup>[11]</sup>	5		ns
t <sub>HZBE</sub>	$\overline{BLE}/\overline{BHE}$ HIGH to High-Z <sup>[11, 12]</sup>		20	ns
<b>Write Cycle<sup>[13]</sup></b>				
t <sub>WC</sub>	Write Cycle Time	55		ns
t <sub>SCE</sub>	$\overline{CE}$ LOW to Write End	40		ns
t <sub>AW</sub>	Address Set-up to Write End	40		ns
t <sub>HA</sub>	Address Hold from Write End	0		ns
t <sub>SA</sub>	Address Set-up to Write Start	0		ns
t <sub>PWE</sub>	$\overline{WE}$ Pulse Width	40		ns
t <sub>BW</sub>	$\overline{BLE}/\overline{BHE}$ LOW to Write End	40		ns
t <sub>SD</sub>	Data Set-up to Write End	25		ns
t <sub>HD</sub>	Data Hold from Write End	0		ns
t <sub>HZWE</sub>	$\overline{WE}$ LOW to High Z <sup>[11, 12]</sup>		20	ns
t <sub>LZWE</sub>	$\overline{WE}$ HIGH to Low Z <sup>[11]</sup>	10		ns

**Notes:**

10. Test conditions assume signal transition time of 1V/ns or less, timing reference levels of  $V_{CC(typ.)}/2$ , input pulse levels of 0 to  $V_{CC(typ.)}$ , and output loading of the specified  $I_{OL}$ .
11. At any given temperature and voltage condition, t<sub>HZCE</sub> is less than t<sub>LZCE</sub>, t<sub>HZBE</sub> is less than t<sub>LZBE</sub>, t<sub>HZOE</sub> is less than t<sub>LZOE</sub>.
12. t<sub>HZOE</sub>, t<sub>HZCE</sub>, t<sub>HZBE</sub>, and t<sub>HZWE</sub> transitions are measured when the outputs enter a high-impedance state.
13. The internal Write time of the memory is defined by the overlap of  $\overline{WE}$ ,  $\overline{CE} = V_{IL}$ ,  $\overline{BHE}$  and/or  $\overline{BLE} = V_{IL}$ . All signals must be ACTIVE to initiate a write and any of these signals can terminate a write by going INACTIVE. The data input set-up and hold timing should be referenced to the edge of the signal that terminates the write.

### Switching Waveforms

#### Read Cycle No. 1 (Address Transition Controlled)<sup>[14, 15]</sup>

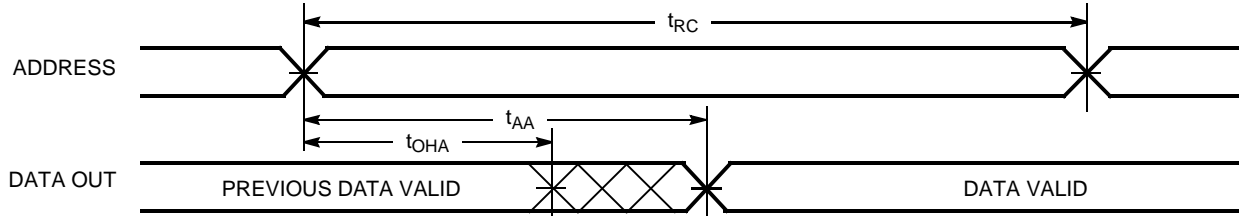

#### Read Cycle No. 2 ( $\overline{OE}$ Controlled)<sup>[15, 16]</sup>

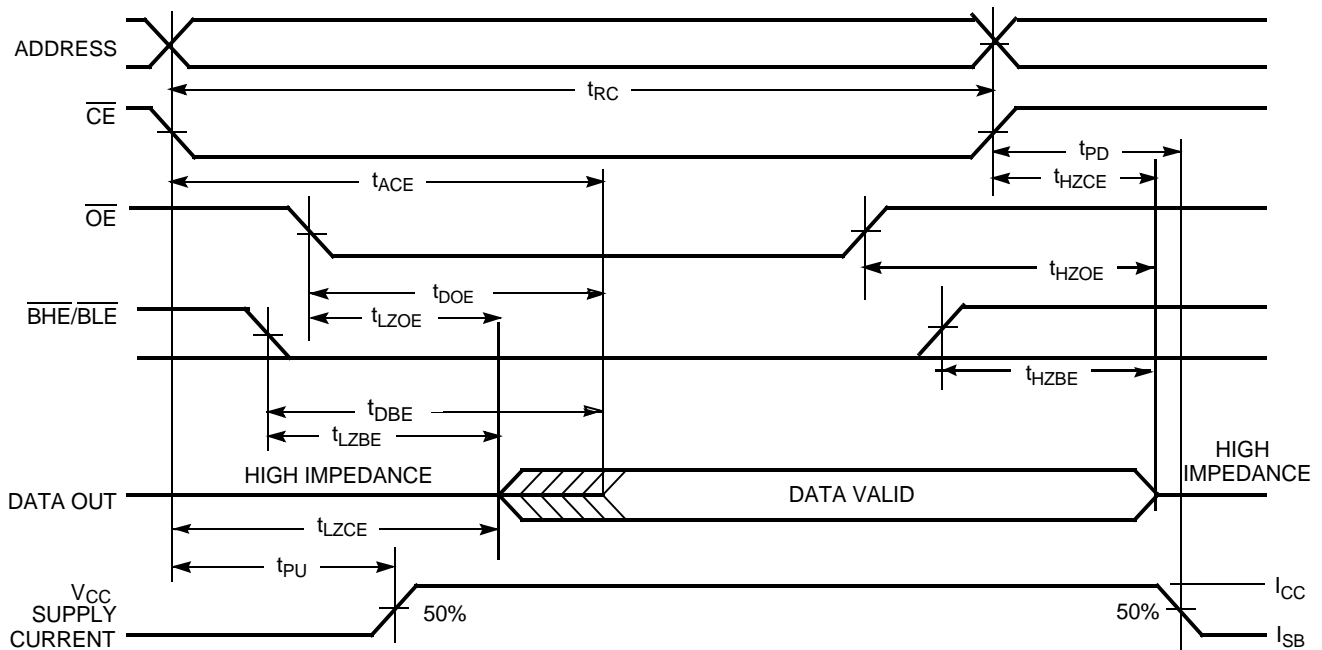

**Notes:**

- 14. Device is continuously selected.  $\overline{OE}$ ,  $\overline{CE} = V_{IL}$ ,  $\overline{BHE}$ ,  $\overline{BLE} = V_{IL}$ .
- 15. WE is HIGH for Read cycle.
- 16. Address valid prior to or coincident with  $\overline{CE}$ ,  $\overline{BHE}$ ,  $\overline{BLE}$  transition LOW.

Switching Waveforms(continued)

Write Cycle No. 1 ( $\overline{WE}$  Controlled)<sup>[12, 13, 16, 17, 18]</sup>

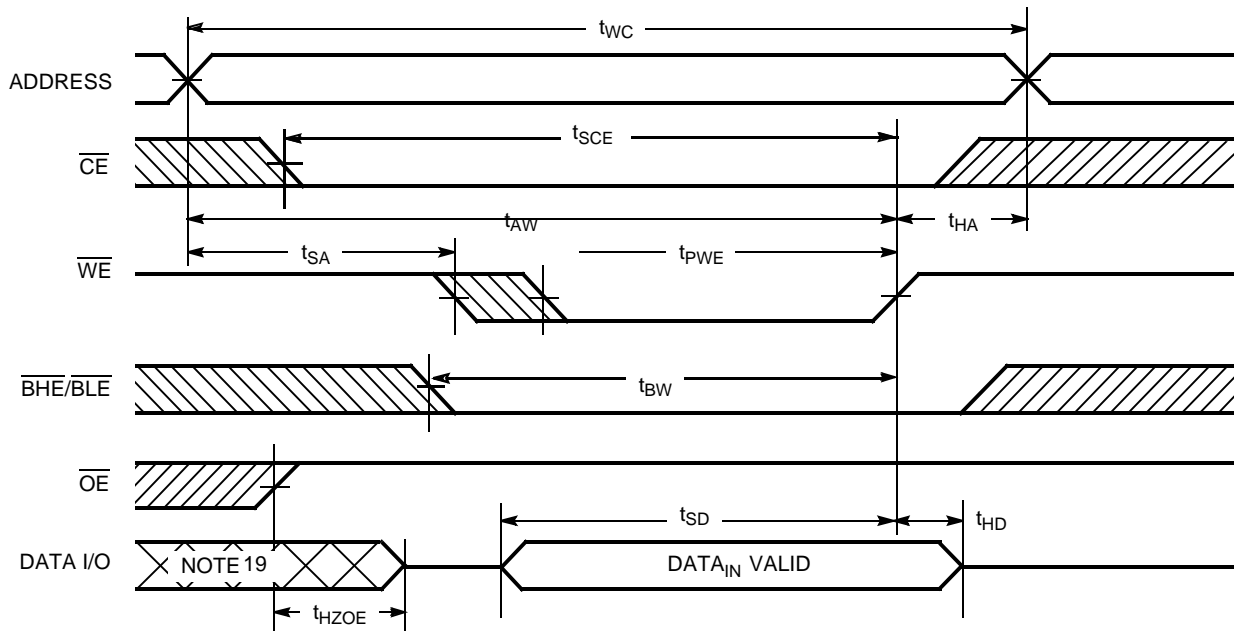

Write Cycle No. 2 ( $\overline{CE}$  Controlled)<sup>[12, 13, 16, 17, 18]</sup>

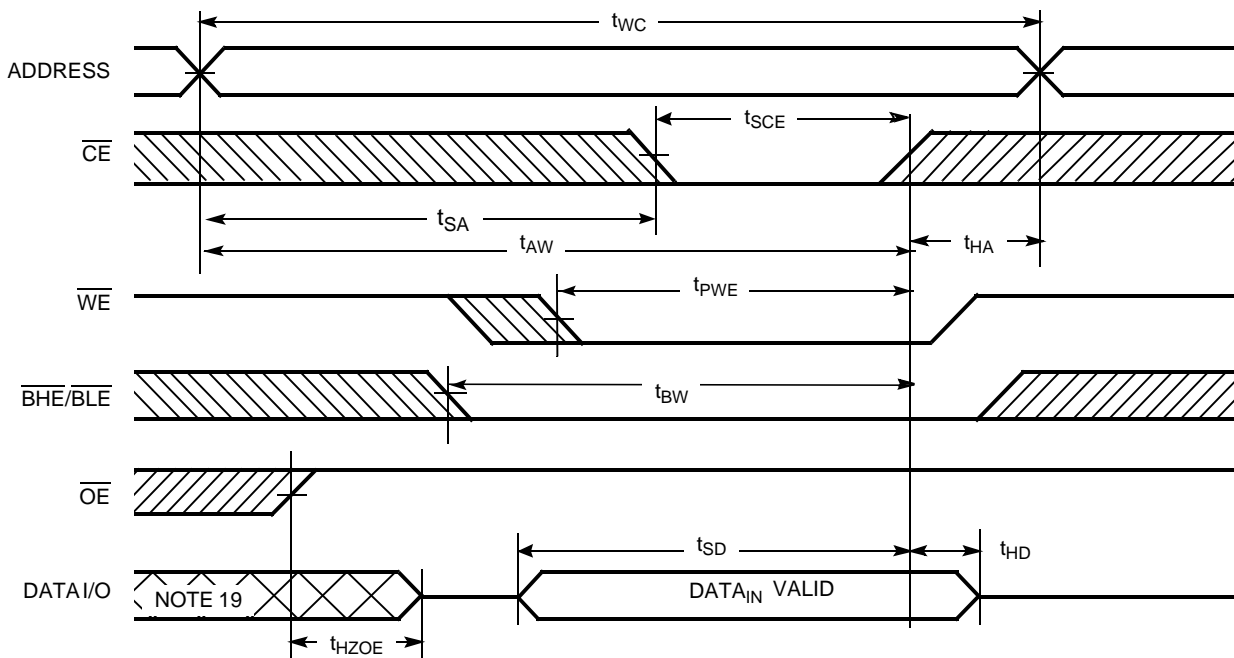

Notes:

- 17. Data I/O is high-impedance if  $\overline{OE} = V_{IH}$ .
- 18. If  $\overline{CE}$  goes HIGH simultaneously with  $\overline{WE}$  HIGH, the output remains in a high-impedance state.
- 19. During the DON'T CARE period in the DATA I/O waveform, the I/Os are in output state and input signals should not be applied.

Switching Waveforms(continued)

Write Cycle No. 3 ( $\overline{WE}$  Controlled,  $\overline{OE}$  LOW)<sup>[17, 18]</sup>

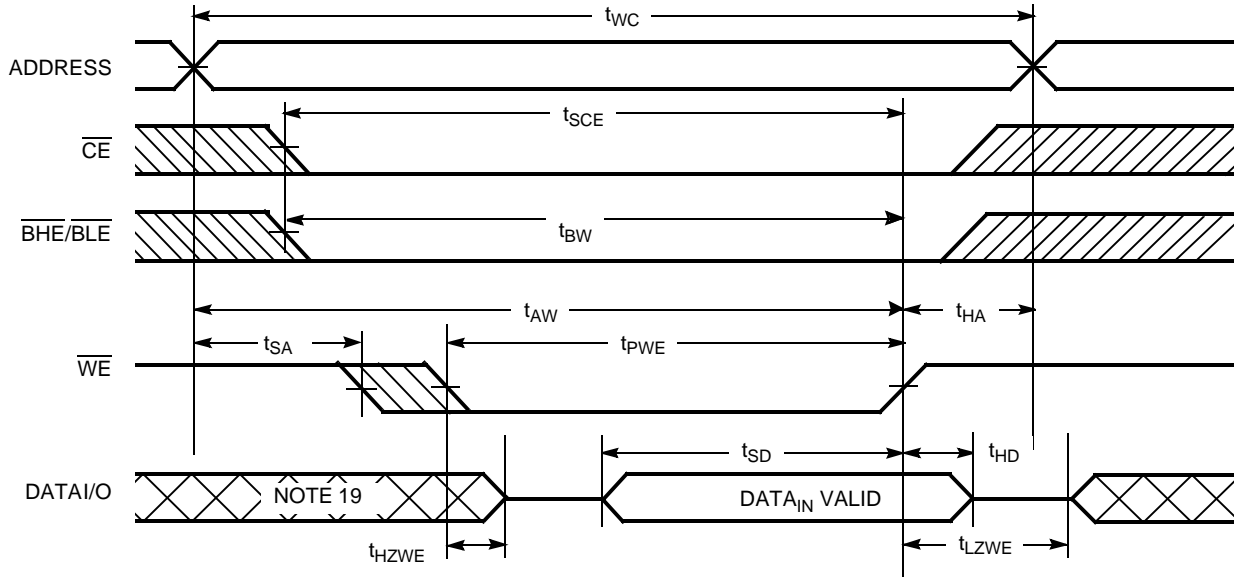

Write Cycle No. 4 ( $\overline{BHE}/\overline{BLE}$ -controlled,  $\overline{OE}$  LOW)<sup>[17, 18]</sup>

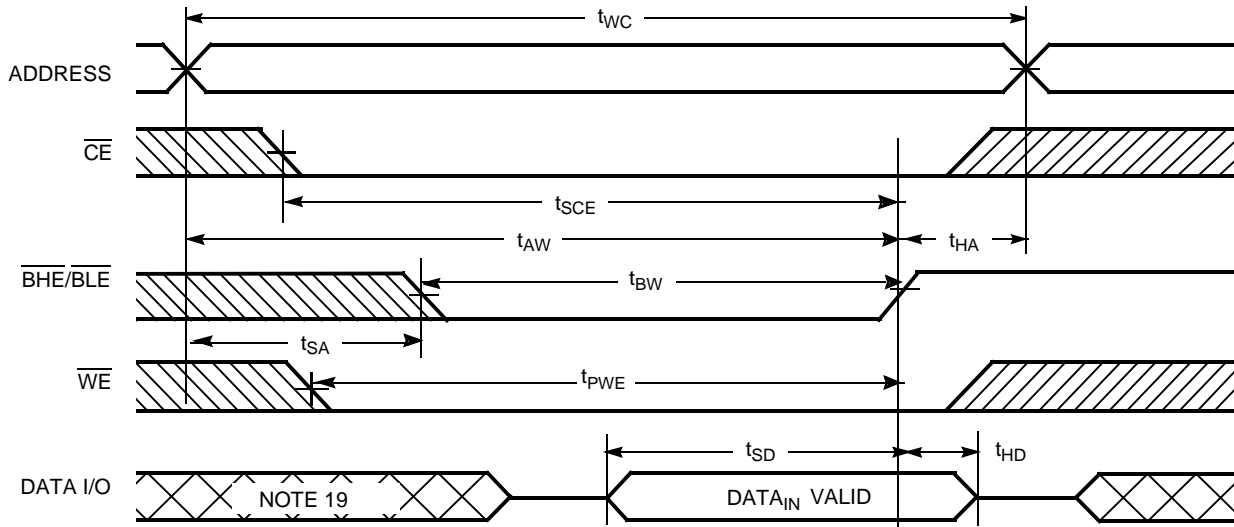



**Truth Table**

$\overline{CE}$	$\overline{WE}$	$\overline{OE}$	$\overline{BHE}$	$\overline{BLE}$	Inputs/Outputs	Mode	Power
H	X	X	X	X	High Z	Deselect/Power-Down	Standby ( $I_{SB}$ )
L	X	X	H	H	High Z	Output Disabled	Active ( $I_{CC}$ )
L	H	L	L	L	Data Out ( $I/O_0$ – $I/O_{15}$ )	Read	Active ( $I_{CC}$ )
L	H	L	H	L	High Z ( $I/O_8$ – $I/O_{15}$ ); Data Out ( $I/O_0$ – $I/O_7$ )	Read	Active ( $I_{CC}$ )
L	H	L	L	H	Data Out ( $I/O_8$ – $I/O_{15}$ ); High Z ( $I/O_0$ – $I/O_7$ )	Read	Active ( $I_{CC}$ )
L	L	X	L	L	Data In ( $I/O_0$ – $I/O_{15}$ )	Write	Active ( $I_{CC}$ )
L	L	X	H	L	High Z ( $I/O_8$ – $I/O_{15}$ ); Data In ( $I/O_0$ – $I/O_7$ )	Write	Active ( $I_{CC}$ )
L	L	X	L	H	Data in ( $I/O_8$ – $I/O_{15}$ ); High Z ( $I/O_0$ – $I/O_7$ )	Write	Active ( $I_{CC}$ )
L	H	H	L	L	High Z	Output Disabled	Active ( $I_{CC}$ )
L	H	H	H	L	High Z	Output Disabled	Active ( $I_{CC}$ )
L	H	H	L	H	High Z	Output Disabled	Active ( $I_{CC}$ )

**Ordering Information**

Speed (ns)	Ordering Code	Package Diagram	Package Type	Operating Range
55	CY62126DV30LL-55BVI	51-85150	48-ball Fine-Pitch Ball Grid Array (6 x 8 x 1 mm)	Industrial
	CY62126DV30LL-55BVXI		48-ball Fine-Pitch Ball Grid Array (6 x 8 x 1 mm) (Pb-free)	
	CY62126DV30LL-55ZI	51-85087	44-pin TSOP II	
	CY62126DV30LL-55ZXI		44-pin TSOP II (Pb-free)	
	CY62126DV30L-55BVXE	51-85150	48-ball Fine-Pitch Ball Grid Array (6 x 8 x 1 mm) (Pb-free)	Automotive
	CY62126DV30L-55ZSXE	51-85087	44-pin TSOP II (Pb-free)	

Please contact your local Cypress sales representative for availability of these parts

Package Diagrams

48-ball VFBGA (6 x 8 x 1 mm) (51-85150)

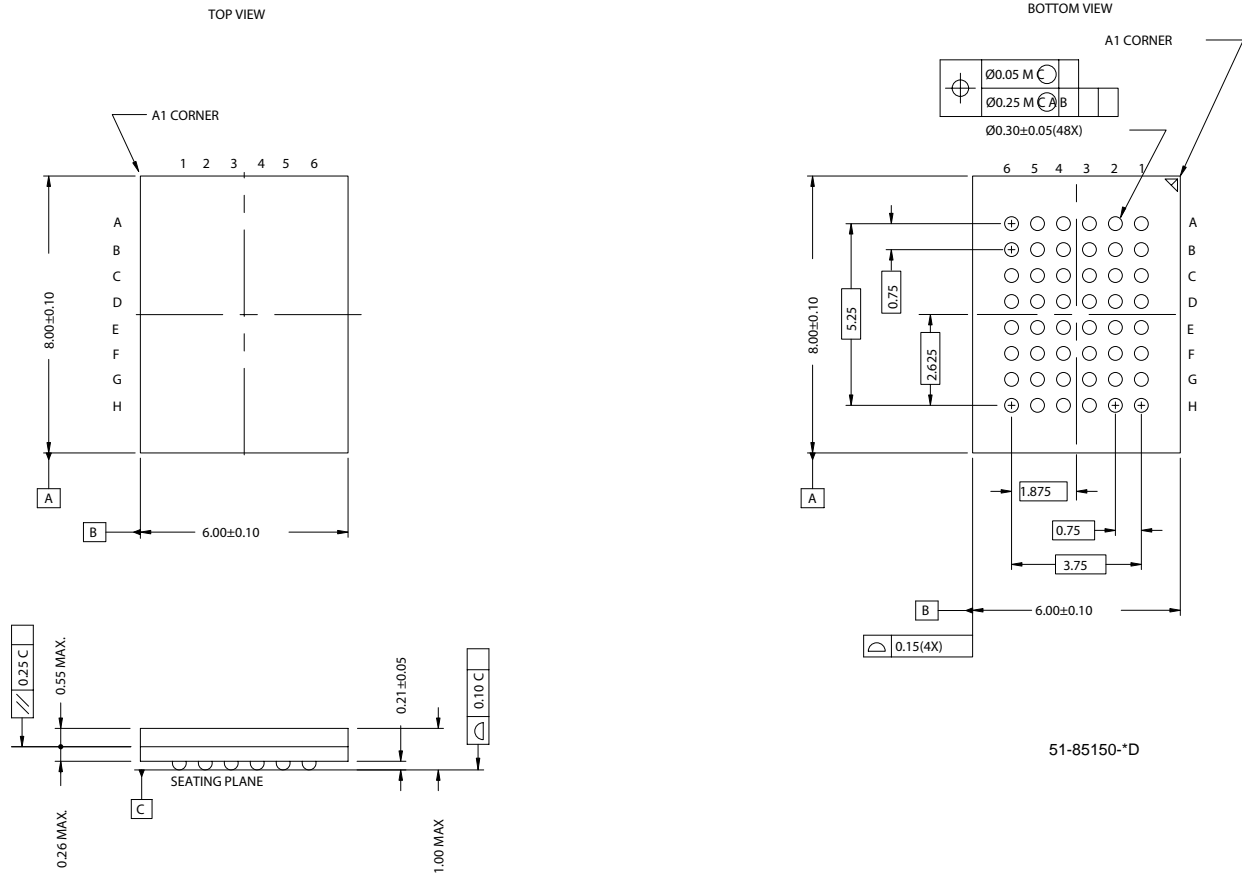

Package Diagrams(continued)

44-pin TSOP II (51-85087)

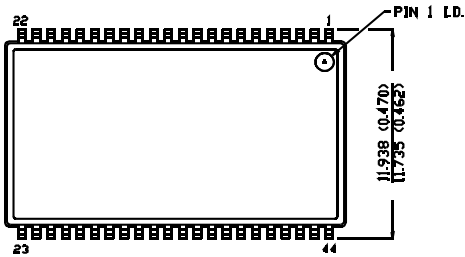

TOP VIEW

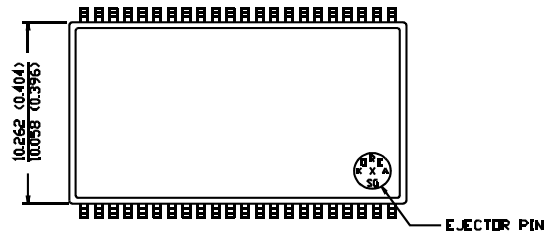

BOTTOM VIEW

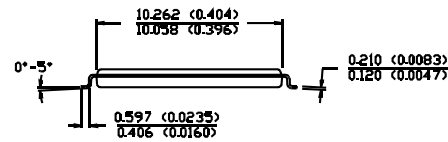
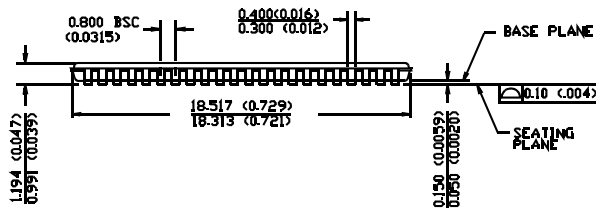

51-85087-A

MoBL is a registered trademark, and MoBL2 and More Battery Life are trademarks of Cypress Semiconductor. All product and company names mentioned in this document are the trademarks of their respective holders.

**Document History Page**

Document Title: CY62126DV30 MoBL® 1-Mbit (64K x 16) Static RAM				
Document Number: 38-05230				
REV.	ECN NO.	Issue Date	Orig. of Change	Description of Change
**	117689	08/27/02	JUI	New Data Sheet
*A	127313	06/13/03	MPR	Changed From Advanced Status to Preliminary. Changed I <sub>SB2</sub> to 5 $\mu$ A (L), 4 $\mu$ A (LL) Changed I <sub>CCDR</sub> to 4 $\mu$ A (L), 3 $\mu$ A (LL) Changed C <sub>IN</sub> from 6 pF to 8 pF
*B	128340	07/22/03	JUI	Changed from Preliminary to Final Add 70-ns speed, updated ordering information
*C	129002	08/29/03	CDY	Changed I <sub>CC</sub> 1 MHz typ from 0.5 mA to 0.85 mA
*D	238050	See ECN	AJU	Fixed typo: Changed t <sub>DBE</sub> from 70 ns to 35 ns
*E	316039	See ECN	PCI	Added 45-ns Speed Bin in AC, DC and Ordering Information tables Added Footnote #8 on page #4 Added Pb-free package ordering information on page # 9 Changed 44-pin TSOP-II package name from Z44 to ZS44
*F	335861	See ECN	SYT	Added Temperature Ranges in the Features Section on Page # 1 Added Automotive Product Information for CY62126DV30-L for 55 ns Added I <sub>SB1</sub> and I <sub>SB2</sub> values for Automotive range of CY62126DV30-L for 55 ns Added Automotive Information for I <sub>CCDR</sub> in the Data Retention Characteristics table Added Pb-free packages in the ordering information Changed 44-pin TSOP-II package name from ZS44 to Z44
*G	357256	See ECN	PCI	Added Pin Configuration and Package Diagram for 56-Lead QFN Package Updated Thermal Characteristics and Ordering Information Table Added Automotive Specs for I <sub>Ix</sub> and I <sub>Oz</sub> in the DC Electrical Characteristics table on Page# 4
*H	486789	See ECN	VKN	Changed the address of Cypress Semiconductor Corporation on Page #1 from "3901 North First Street" to "198 Champion Court" Removed 45 ns and 70ns Speed bin from Product offering Removed 56-pin QFN package Updated Ordering Information Table