

MATCHED DUAL OPERATIONAL AMPLIFIERS

... designed for use as summing amplifiers, integrators, or amplifiers with operating characteristics as a function of the external feedback components. Ideal for chopper stabilized applications where extremely high gain is required with excellent stability.

Typical Amplifier Features:

- High-Performance Open Loop Gain Characteristics – $A_{VOL} = 45,000$ typical
- Low Temperature Drift – $\pm 3 \mu V/^\circ C$
- Large Output Voltage Swing – $\pm 14 V$ typical @ $\pm 15 V$ Supply

MAXIMUM RATINGS ($T_A = +25^\circ C$)

Rating	Symbol	Value	Unit
Power Supply Voltage	V_{CC} V_{EE}	+18 -18	Vdc
Differential Input Voltage Range	V_{IDR}	± 5.0	Volts
Common-Mode Input Voltage Range	V_{ICR}	$\pm V_{CC}$	Volts
Output Short Circuit Duration	t_S	5.0	s
Power Dissipation (Package Limitation)	P_D		
Ceramic Package		750	mW
Derate above $T_A = +25^\circ C$		6.0	mW/ $^\circ C$
Plastic Package MC1437P		625	mW
Derate above $T_A = +25^\circ C$		5.0	mW/ $^\circ C$
Operating Ambient Temperature Range	T_A	-55 to +125 0 to +70	$^\circ C$
Storage Temperature Range	T_{Stg}	-65 to +150	$^\circ C$

FIGURE 1 – CIRCUIT SCHEMATIC

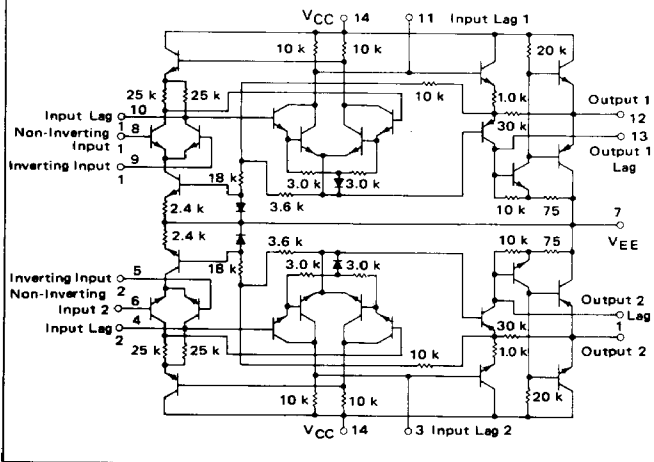

MC1437
MC1537

DUAL MC1709
OPERATIONAL AMPLIFIERS

SILICON MONOLITHIC
INTEGRATED CIRCUIT

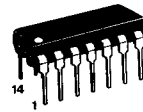

P SUFFIX
PLASTIC PACKAGE
CASE 646
(MC1437P Only)

PIN CONNECTIONS

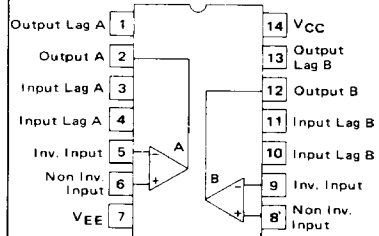

L SUFFIX
CERAMIC PACKAGE
CASE 632

ORDERING INFORMATION

Device	Temperature Range	Package
MC1437L	0 $^\circ C$ to +70 $^\circ C$	Ceramic DIP
MC1437P		Plastic DIP
MC1537L	-55 $^\circ C$ to +125 $^\circ C$	Ceramic DIP

MC1437, MC1537

ELECTRICAL CHARACTERISTICS – Each Amplifier ($V_{CC} = +15$ Vdc, $V_{EE} = -15$ Vdc, $T_A = +25^\circ\text{C}$ unless otherwise noted.)

Characteristic	Symbol	MC1537			MC1437			Unit
		Min	Typ	Max	Min	Typ	Max	
Open Loop Voltage Gain ($R_L = 5.0$ k Ω , $V_O = \pm 10$ V, $T_A = T_{low}$ ① to T_{high} ②)	A_{VOL}	25,000	45,000	70,000	15,000	45,000	–	–
Output Impedance ($f = 20$ Hz)	z_o	–	30	–	–	30	–	Ω
Input Impedance ($f = 20$ Hz)	z_i	150	400	–	50	150	–	k Ω
Output Voltage Range ($R_L = 10$ k Ω) ($R_L = 2.0$ k Ω)	V_{OR}	± 12 ± 10	± 14 ± 13	–	± 12 –	± 14 –	–	V_{peak}
Input Common-Mode Voltage Range	V_{ICR}	± 8.0	± 10	–	± 8.0	± 10	–	V_{peak}
Common-Mode Rejection Ratio	CMRR	70	100	–	65	100	–	dB
Input Bias Current ($I_{IB} = \frac{I_1 + I_2}{2}$) ($T_A = +25^\circ\text{C}$) ($T_A = T_{low}$ ①)	I_{IB}	–	0.2 0.5	0.5 1.5	–	0.4 –	1.5 2.0	μA
Input Offset Current ($I_{IO} = I_1 - I_2$) ($I_{IO} = I_1 - I_2$, $T_A = T_{low}$ ①) ($I_{IO} = I_1 - I_2$, $T_A = T_{high}$ ②)	I_{IO}	–	0.05 –	0.2 0.5 0.2	–	0.05 –	0.5 0.75 0.75	μA
Input Offset Voltage ($T_A = +25^\circ\text{C}$) ($T_A = T_{low}$ ① to T_{high} ②)	V_{IO}	–	1.0 –	5.0 6.0	–	1.0 –	7.5 10	mV
Step Response { Gain = 100, 5% overshoot, $R_1 = 1$ k Ω , $R_2 = 100$ k Ω , $R_3 = 1.5$ k Ω , $C_1 = 100$ pF, $C_2 = 3.0$ pF } { Gain = 10, 10% overshoot, $R_1 = 1$ k Ω , $R_2 = 10$ k Ω , $R_3 = 1.5$ k Ω , $C_1 = 500$ pF, $C_2 = 20$ pF } { Gain = 1, 5% overshoot, $R_1 = 10$ k Ω , $R_2 = 10$ k Ω , $R_3 = 1.5$ k Ω , $C_1 = 5000$ pF, $C_2 = 200$ pF }	t_{TLH} t_{PLH} - t_{PHL} SR	–	0.8 0.38 12	–	–	0.8 0.38 12	–	μs μs V/ μs
	t_{TLH} t_{PLH} - t_{PHL} SR	–	0.6 0.34 1.7	–	–	0.6 0.34 1.7	–	μs μs V/ μs
	t_{TLH} t_{PLH} - t_{PHL} SR	–	2.2 1.3 0.25	–	–	2.2 1.3 0.25	–	μs μs V/ μs
Average Temperature Coefficient of Input Offset Voltage ($R_S = 50$ Ω , $T_A = T_{low}$ ① to T_{high} ②) ($R_S \leq 10$ k Ω , $T_A = T_{low}$ ① to T_{high} ②)	$\Delta V_{IO}/\Delta T$	–	1.5 3.0	–	–	1.5 3.0	–	$\mu\text{V}/^\circ\text{C}$
Average Temperature Coefficient of Input Offset Voltage ($T_A = T_{low}$ ① to $+25^\circ\text{C}$) ($T_A = +25^\circ\text{C}$ to T_{high} ②)	$\Delta I_{IO}/\Delta T$	–	0.7 0.7	–	–	0.7 0.7	–	nA/ $^\circ\text{C}$
DC Power Consumption (Total) (Power Supply = ± 15 V, $V_O = 0$)	P_C	–	160	225	–	160	225	mW
Positive Supply Sensitivity (V_{EE} constant)	PSS+	–	10	150	–	10	200	$\mu\text{V}/\text{V}$
Negative Supply Sensitivity (V_{CC} constant)	PSS-	–	10	150	–	10	200	$\mu\text{V}/\text{V}$

① $T_{low} = 0^\circ\text{C}$ for MC1437
= -55°C for MC1537

② $T_{high} = +70^\circ\text{C}$ for MC1437
= $+125^\circ\text{C}$ for MC1537

MATCHING CHARACTERISTICS

Open Loop Voltage Gain	$A_{VOL1} \cdot A_{VOL2}$	–	± 1.0	–	–	± 1.0	–	dB
Input Bias Current	$I_{IB1} \cdot I_{IB2}$	–	± 0.15	–	–	± 0.15	–	μA
Input Offset Current	$I_{IO1} \cdot I_{IO2}$	–	± 0.02	–	–	± 0.02	–	μA
Average Temperature Coefficient	$\left \frac{\Delta I_{IO1}}{\Delta T} \right \cdot \left \frac{\Delta I_{IO2}}{\Delta T} \right $	–	± 0.2	–	–	± 0.2	–	nA/ $^\circ\text{C}$
Input Offset Voltage	$V_{IO1} \cdot V_{IO2}$	–	± 0.2	–	–	± 0.2	–	mV
Average Temperature Coefficient	$\left \frac{\Delta V_{IO1}}{\Delta T} \right \cdot \left \frac{\Delta V_{IO2}}{\Delta T} \right $	–	± 0.5	–	–	± 0.5	–	$\mu\text{V}/^\circ\text{C}$
Channel Separation ($f = 10$ kHz)	$\frac{e_{o1}}{e_{o2}}$	–	90	–	–	90	–	dB

MC1437, MC1537

TYPICAL OUTPUT CHARACTERISTICS

FIGURE 3 – TEST CIRCUIT
 $V_{CC} = +15 \text{ Vdc}$, $V_{EE} = 15 \text{ Vdc}$, $T_A = 25^\circ\text{C}$

2

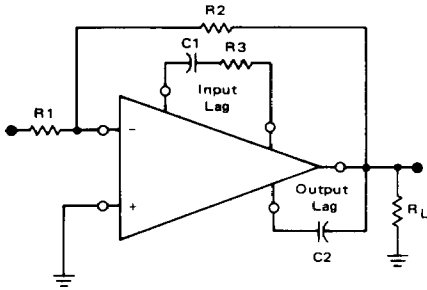

FIGURE NO.	CURVE NO.	VOLTAGE GAIN	TEST CONDITIONS					OUTPUT NOISE (mV _{rms})
			R ₁ (Ω)	R ₂ (Ω)	R ₃ (Ω)	C ₁ (pF)	C ₂ (pF)	
4	1	1	10 k	10 k	1.5 k	5.0 k	200	0.10
	2	10	10 k	100 k	1.5 k	500	20	0.14
	3	100	10 k	1.0 M	1.5 k	100	3.0	0.7
	4	1000	1.0 k	1.0 M	0	10	3.0	5.2
5	1	1	10 k	10 k	1.5 k	5.0 k	200	0.10
	2	10	10 k	100 k	1.5 k	500	20	0.14
	3	100	10 k	1.0 M	1.5 k	100	3.0	0.7
	4	1000	1.0 k	1.0 M	0	10	3.0	5.2
6	1	AVOL	0	∞	1.5 k	5.0 k	200	5.5
	2	AVOL	0	∞	1.5 k	500	20	10.5
	3	AVOL	0	∞	1.5 k	100	3.0	21.0
	4	AVOL	0	∞	0	10	3.0	39.0
	5	AVOL	0	∞	∞	0	3.0	—

FIGURE 4 – LARGE SIGNAL SWING versus FREQUENCY

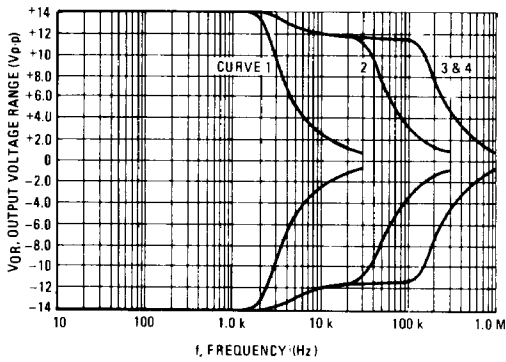

FIGURE 5 – VOLTAGE GAIN versus FREQUENCY

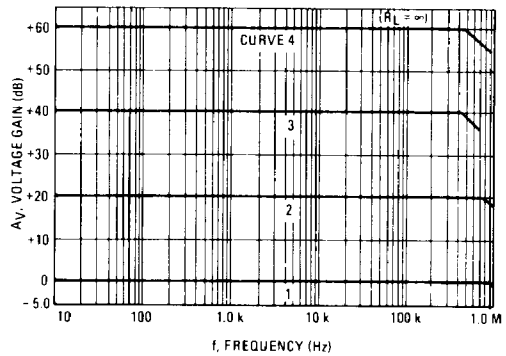

FIGURE 6 – OPEN LOOP VOLTAGE GAIN versus FREQUENCY

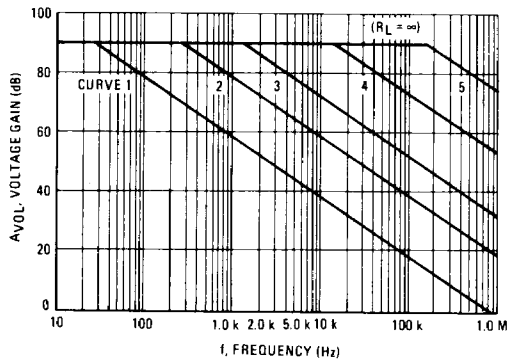
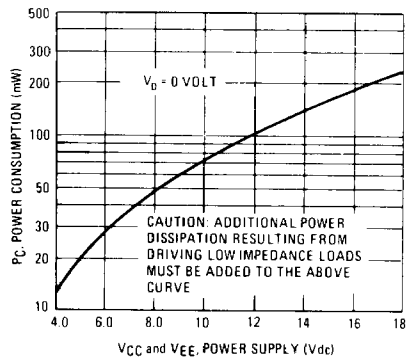

FIGURE 7 – TOTAL POWER CONSUMPTION versus POWER SUPPLY VOLTAGE



TYPICAL CHARACTERISTICS (continued)

FIGURE 8 – VOLTAGE GAIN versus POWER SUPPLY VOLTAGE

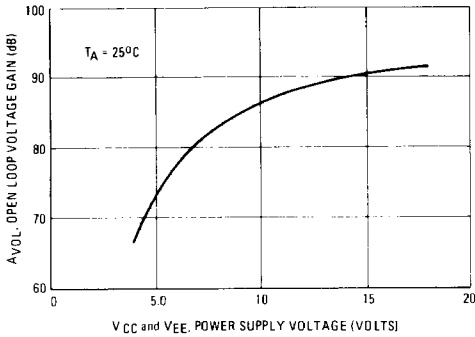

FIGURE 9 – COMMON INPUT SWING versus POWER SUPPLY VOLTAGE

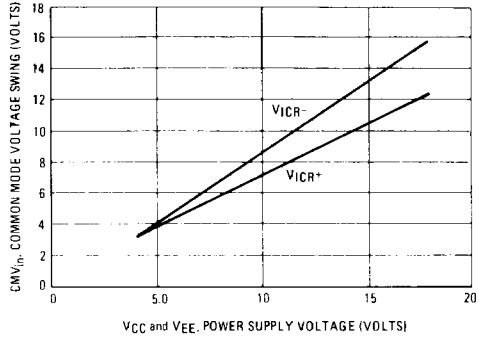

FIGURE 10 – INPUT OFFSET VOLTAGE versus TEMPERATURE

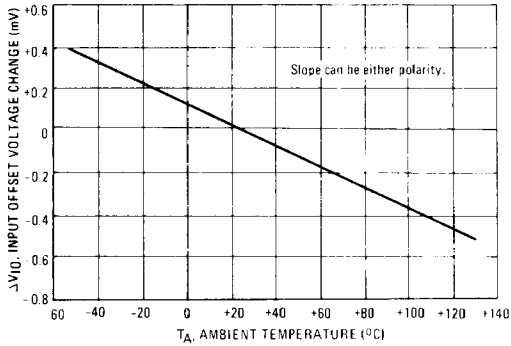

FIGURE 11 – OUTPUT NOISE VOLTAGE versus SOURCE RESISTANCE

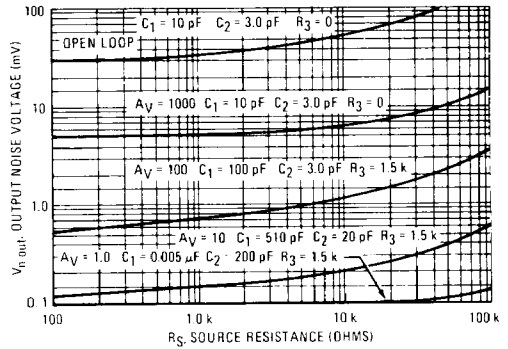
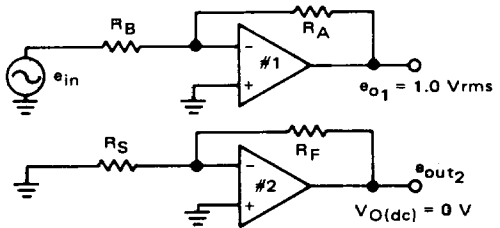
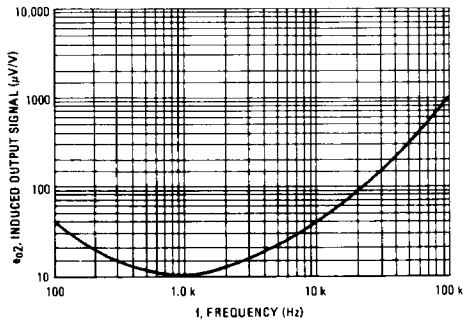

FIGURE 12 – INDUCED OUTPUT SIGNAL (CHANNEL SEPARATION) versus FREQUENCY



Induced output signal (μV of induced output signal in amplifier #2 per volt of output signal at amplifier #1).