

MN3006

128-STAGE ECONOMY TYPE BBD

General description

The MN3006 is a 128-stage BBD with wide dynamic range and low distortion manufactured by using P-channel low noise silicon gate process.

The MN3006 is designed to obtain variable range of delay time from 0.32 to 6.4ms suitably applied for tolemoro and vibrato effects in electronic musical instruments. Compact 8 lead dual-in-line plastic package.

Features

- Variable delay time of audio signal: 0.32 ~ 6.4ms.
- No insertion loss: $L_i = -\text{dB typ.}$
- Wide dynamic range: $S/N \approx 90\text{dB typ.}$
- Wide frequency response: $f_i \leq 12\text{KHz.}$
- Low distortion: $\text{THD} = 0.2\% \text{ typ.}$
- Low noise: $V_{\text{no}} = 0.2\text{mVrms max.}$
- P channel low noise silicon gate process.
- Compact 8 lead dual-in-line plastic package.

Applications

- Vibrato and chorus effects in electronic musical instruments.
- Reveberation effect in electronic musical instruments.
- Variable or fixed delay of analog signals.

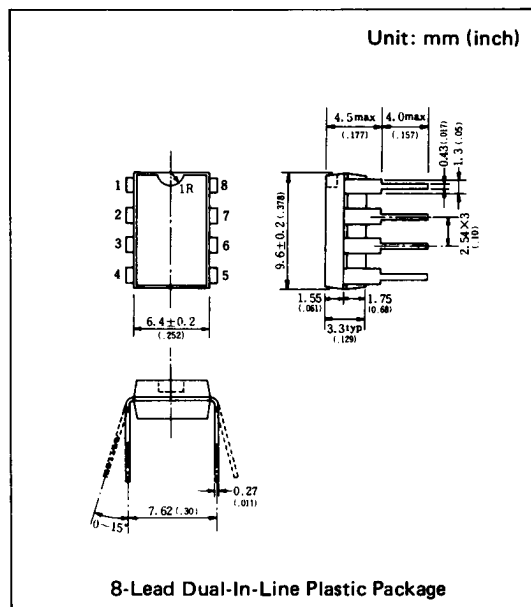

Block Diagram

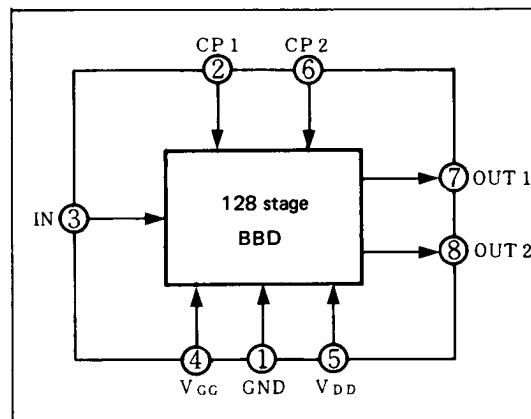

Quick Reference Data

Item	Symbol	Value	Unit
Supply Voltage	$V_{\text{DD}}, V_{\text{GG}}$	$-15, V_{\text{DD}} + 1$	V
Signal Delay Time	t_d	0.32~6.4	ms
Total Harmonic Distortion	THD	0.2	%
Signal to Noise Ratio	S/N	90	dB

■ Absolute Maximum Ratings (Ta = 25°C)

Item	Symbol	Rating	Unit
Terminal Voltage	V _{DD} , V _{GG} , V _{CP} , V _i	-18~+0.3	V
Output Voltage	V _o	-18~+0.3	V
Operating Temperature	T _{opr}	-20~+60	°C
Storage Temperature	T _{stg}	-55~+125	°C

■ Operating Conditions (Ta = 25°C)

Item	Symbol	Condition	Min.	Typ.	Max.	Unit
Drain Supply Voltage	V _{DD}		-14	-15	-16	V
Gate Supply Voltage	V _{GG}			V _{DD} + 1		V
Clock Voltage "H" Level	V _{CPH}		0		-1	V
Clock Voltage "L" Level	V _{CPL}			V _{DD}		V
Clock Input Capacitance	C _{CP}				100	pF
Clock Frequency	f _{CP}		10		200	kHz
Clock Pulse Width *2	t _{cpw}				0.5T *2	
Clock Rise Time *2	t _{cpr}				500	ns
Clock Fall Time *2	t _{cpf}				500	ns
Clock Cross Point	V _x		0		-3	V
Input DC Bias	V _{Bias}		-5		-10	V

■ Electrical Characteristics (Ta = 25°C, V_{DD} = V_{CPL} = -15V, V_{CPH} = 0V, V_{GG} = -14V, R_L = 100kΩ)

Item	Symbol	Condition	Min.	Typ.	Max.	Unit
Signal Delay Time	t _D		0.32		6.4	ms
Input Signal Frequency	f _i	f _{CP} = 40kHz, V _i = 1.8Vrms, 3dB down (0dB at f _i = 1kHz)	12			kHz
Input Signal Swing	V _i	f _{CP} = 40kHz, f _i = 1 kHz, THD=2.5%	1.8			Vrms
Insertion Loss	L _i	f _{CP} = 40kHz, f _i = 1 kHz, V _i = 1.8Vrms	-4	0	4	dB
Total Harmonic Distortion	THD	f _{CP} = 40kHz, f _i = 1 kHz, V _i = 0.78Vrms		0.2	2.5	%
Noise Voltage	V _{no}	f _{CP} = 100kHz, Weighted by "A" curve		0.08	0.2	mVrms
Signal to Noise Ratio	S/N	Maximum output voltage to noise voltage		90		dB

*1 Clock Pulse Waveforms

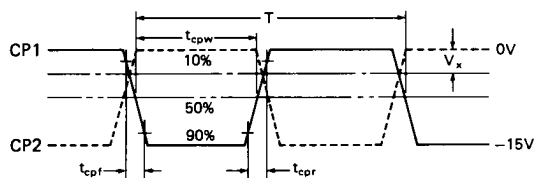

*2 T = 1/f_{cp} (Clock period)

■ Terminal Assignments

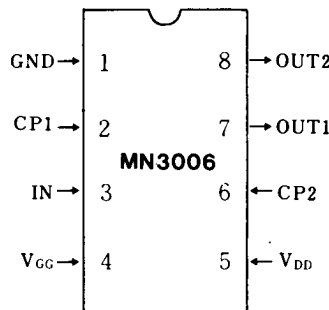

(Top View)

■ Circuit Diagram

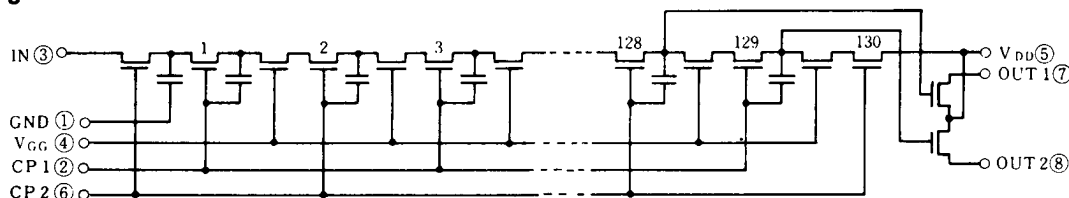

■ Typical Electrical Characteristic Curves

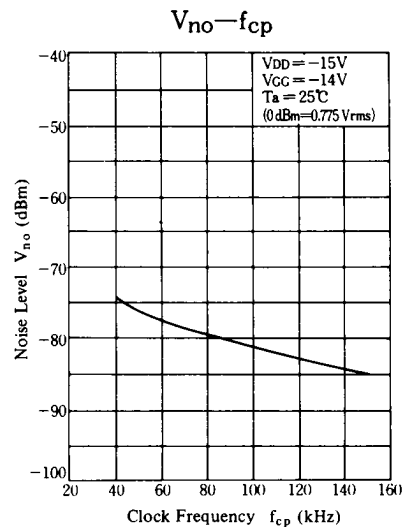
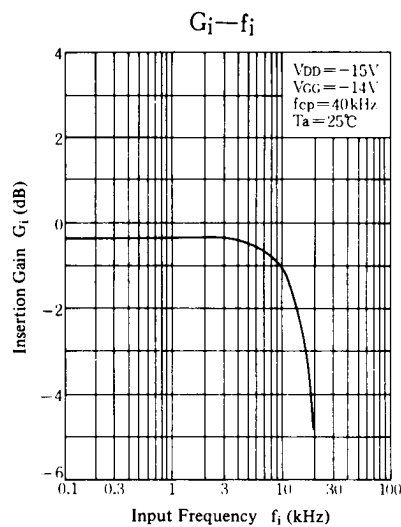
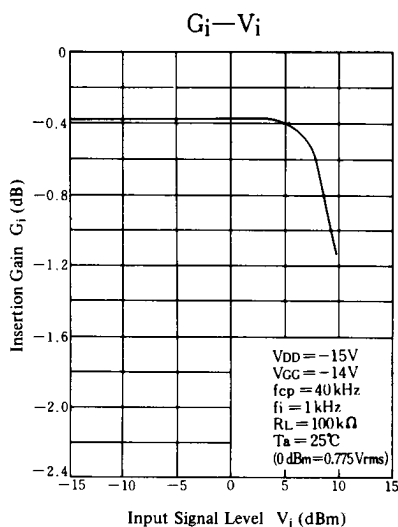
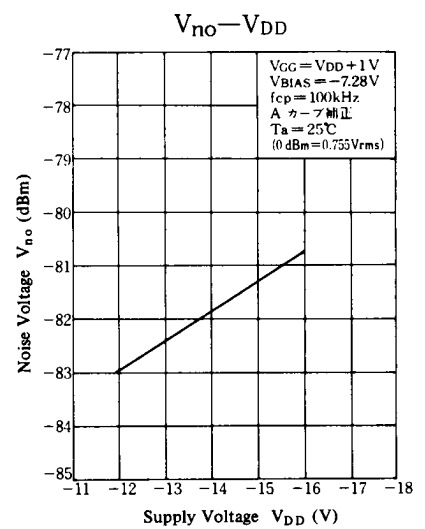
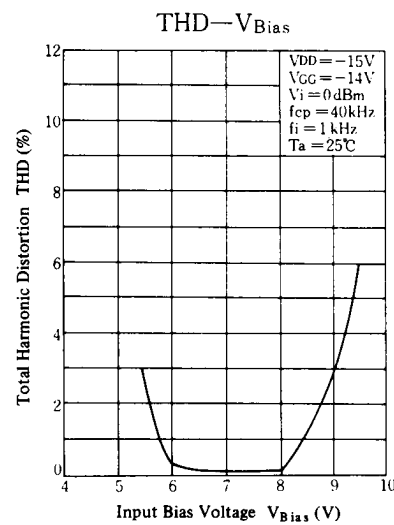
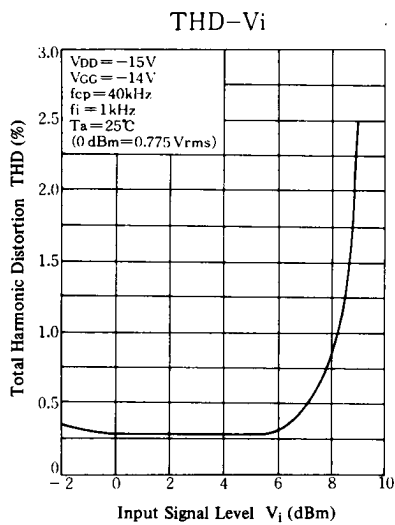
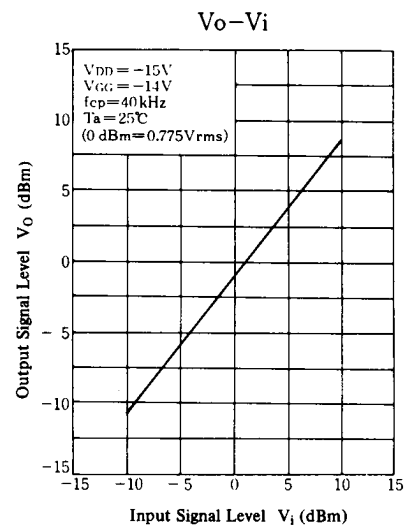
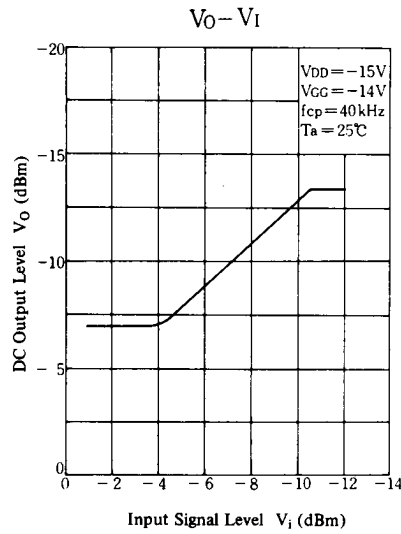
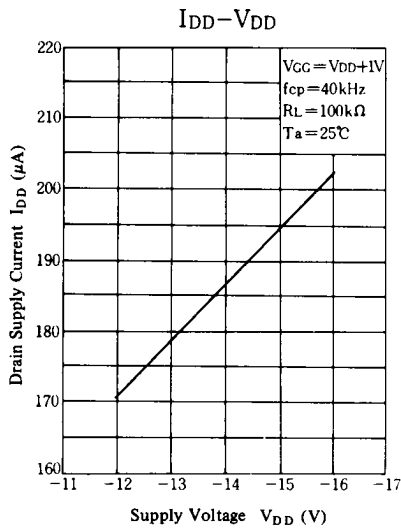

Supply Voltage Characteristics

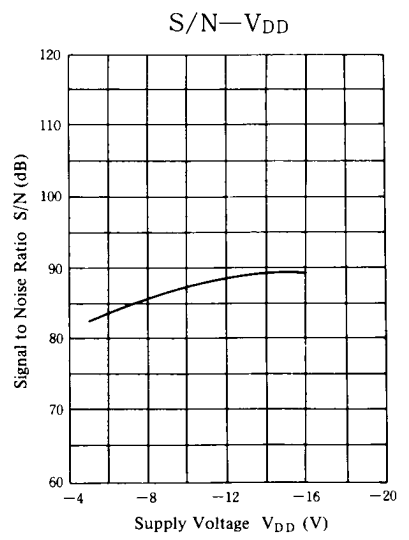
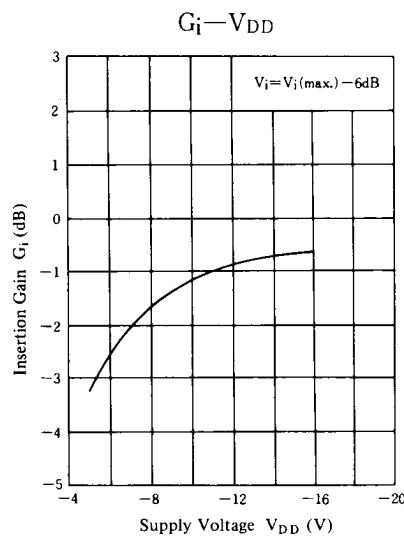
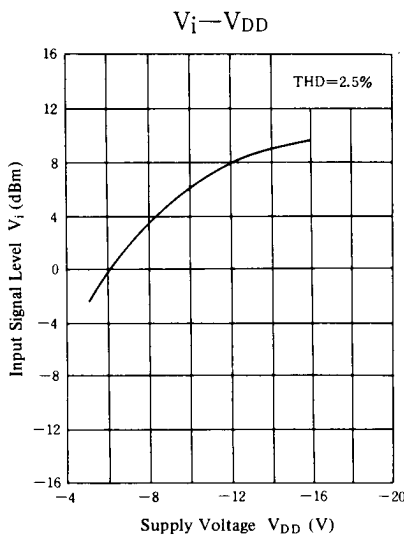
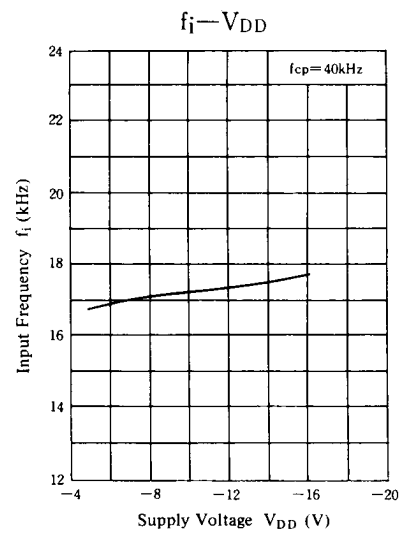
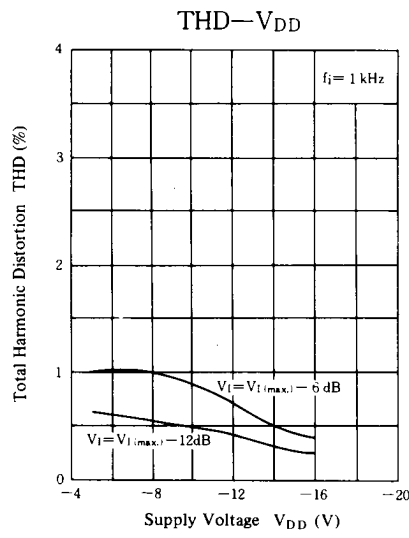
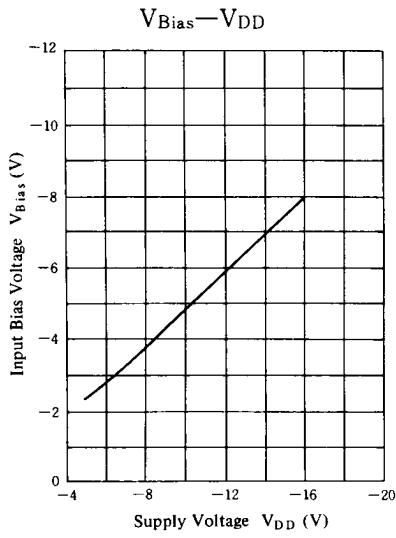

■ Example of application circuit

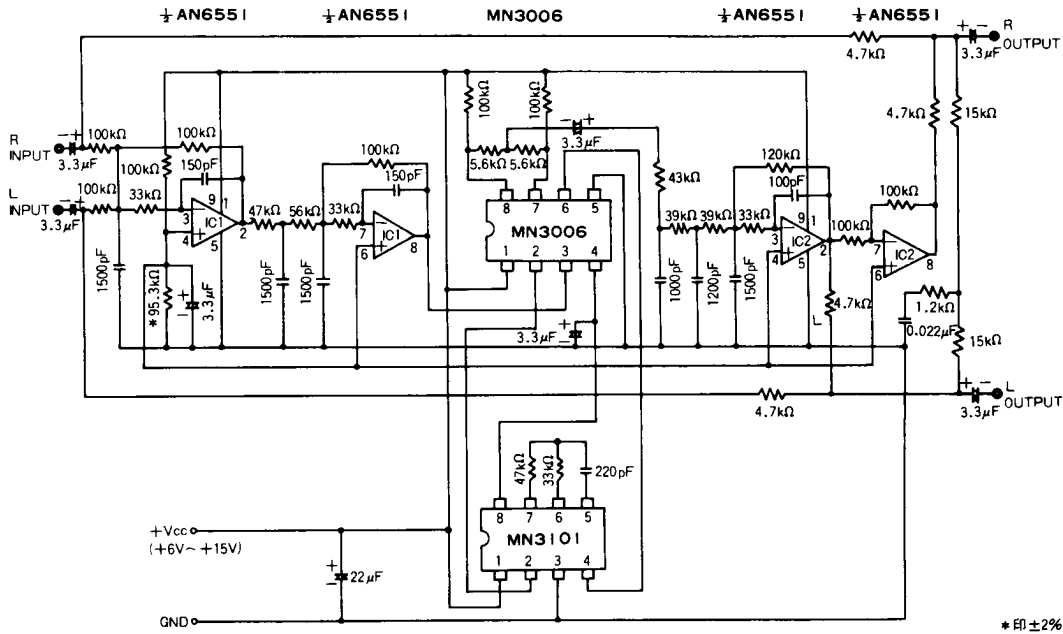

Sound field magnifying effect generating circuit

Sound field magnifying effect generating circuit

Isn't it really wonderful if the speaker reproduction of sound for a grand hall can be got in the listening room or the car? Application of the sound image control technology and the delay characteristic of the BBD makes it possible to realize the above effect easily.

In listening through a speaker in the room, the listener feels the distance and direction up to the speaker. As to the directional sense, for instance, there occurs some difference in the time for both direct and indirect sounds to reach his left and right ears depending on the position of the sound source, as well as the difference in the sound level, and from these differences the listener feels the "direction of sound". Further he feels the "distance of sound" from the energy ratio of the direct sound to the indirect sound (reverberation sound). The circuit for generating a sound field magnifying effect reproduces electronically the delicate time lag of these sounds, thereby makes it possible for the listener to feel as if he hears sounds from his surroundings other than the position of the speaker, and thus producing such effect that he is listening sounds in a large hall. Also the fatigue from listening for a long time through a conventional head-phone is eliminated, and the effect similar to that of listening through an ordinary speaker is obtained.