

## AD8541/AD8542/AD8544

### FEATURES

**Single Supply Operation: 2.7 V to 5.5 V**  
**Low Supply Current: 45  $\mu$ A/Amplifier**  
**Wide Bandwidth: 1 MHz**  
**No Phase Reversal**  
**Low Input Currents: 4 pA**  
**Unity Gain Stable**  
**Rail-to-Rail Input and Output**

### APPLICATIONS

**ASIC Input or Output Amplifier**  
**Sensor Interface**  
**Piezo Electric Transducer Amplifier**  
**Medical Instrumentation**  
**Mobile Communication**  
**Audio Output**  
**Portable Systems**

### GENERAL DESCRIPTION

The AD8541/AD8542/AD8544 are single, dual and quad rail-to-rail input and output single supply amplifiers featuring very low supply current and 1 MHz bandwidth. All are guaranteed to operate from a 2.7 V single supply as well as a 5 V supply. These parts provide 1 MHz bandwidth at low current consumption of 45  $\mu$ A per amplifier.

Very low input bias currents enable the AD8541/AD8542/AD8544 to be used for integrators, photodiode amplifiers, piezo electric sensors and other applications with high source impedance. Supply current is only 45  $\mu$ A per amplifier, ideal for battery operation.

Rail-to-rail inputs and outputs are useful to designers buffering ASICs in single supply systems. The AD8541/AD8542/AD8544 are optimized to maintain high gains at lower supply voltages, making them useful for active filters and gain stages.

The AD8541/AD8542/AD8544 are specified over the extended industrial ( $-40^{\circ}\text{C}$  to  $+125^{\circ}\text{C}$ ) temperature range. The AD8541 is available in 8-lead SOIC, 5-lead SC70, and 5-lead SOT-23 packages. The AD8542 is available in 8-lead SOIC, 8-lead MSOP, and 8-lead TSSOP surface-mount packages. The AD8544 is available in 14-lead narrow SOIC, and 14-lead TSSOP surface mount packages. All TSSOP, MSOP, SC70, and SOT versions are available in tape and reel only.

### REV. B

Information furnished by Analog Devices is believed to be accurate and reliable. However, no responsibility is assumed by Analog Devices for its use, nor for any infringements of patents or other rights of third parties which may result from its use. No license is granted by implication or otherwise under any patent or patent rights of Analog Devices.

### PIN CONFIGURATIONS

#### 5-Lead SC70 and SOT-23 (KS and RT Suffixes)

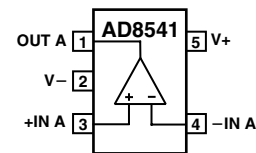

#### 8-Lead SOIC (R Suffix)

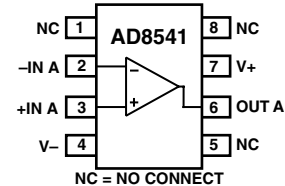

#### 8-Lead SOIC, MSOP, and TSSOP (R, RM, and RU Suffixes)

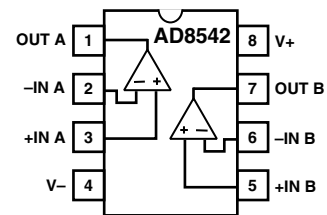

#### 14-Lead SOIC and TSSOP (R and RU Suffixes)

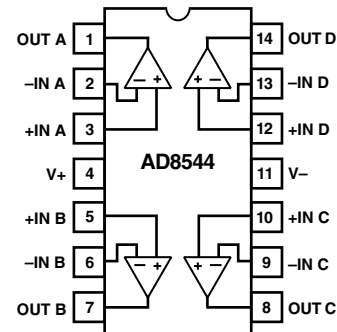

# AD8541/AD8542/AD8544—SPECIFICATIONS

## ELECTRICAL CHARACTERISTICS ( $V_S = 2.7\text{ V}$ , $V_{CM} = 1.35\text{ V}$ , $T_A = 25^\circ\text{C}$ unless otherwise noted)

Parameter	Symbol	Conditions	Min	Typ	Max	Unit
<b>INPUT CHARACTERISTICS</b>						
Offset Voltage	$V_{OS}$	$-40^\circ\text{C} \leq T_A \leq +125^\circ\text{C}$		1	6	mV
Input Bias Current	$I_B$	$-40^\circ\text{C} \leq T_A \leq +125^\circ\text{C}$		4	7	mV
Input Offset Current	$I_{OS}$	$-40^\circ\text{C} \leq T_A \leq +85^\circ\text{C}$			60	pA
		$-40^\circ\text{C} \leq T_A \leq +125^\circ\text{C}$		0.1	100	pA
Input Voltage Range Common-Mode Rejection Ratio	CMRR	$-40^\circ\text{C} \leq T_A \leq +85^\circ\text{C}$			1,000	pA
		$-40^\circ\text{C} \leq T_A \leq +125^\circ\text{C}$			30	pA
		$-40^\circ\text{C} \leq T_A \leq +125^\circ\text{C}$				50
Large Signal Voltage Gain	$A_{VO}$	$V_{CM} = 0\text{ V to } 2.7\text{ V}$	0		2.7	V
		$-40^\circ\text{C} \leq T_A \leq +125^\circ\text{C}$	40	45		dB
Offset Voltage Drift	$\Delta V_{OS}/\Delta T$	$R_L = 100\text{ k}\Omega$ , $V_O = 0.5\text{ V to } 2.2\text{ V}$	38			dB
		$-40^\circ\text{C} \leq T_A \leq +85^\circ\text{C}$	100	500		V/mV
Bias Current Drift	$\Delta I_B/\Delta T$	$-40^\circ\text{C} \leq T_A \leq +125^\circ\text{C}$	50			V/mV
		$-40^\circ\text{C} \leq T_A \leq +125^\circ\text{C}$	2			V/mV
Offset Current Drift	$\Delta I_{OS}/\Delta T$	$-40^\circ\text{C} \leq T_A \leq +125^\circ\text{C}$		4		$\mu\text{V}/^\circ\text{C}$
		$-40^\circ\text{C} \leq T_A \leq +125^\circ\text{C}$		100		$\text{fA}/^\circ\text{C}$
<b>OUTPUT CHARACTERISTICS</b>						
Output Voltage High	$V_{OH}$	$I_L = 1\text{ mA}$ $-40^\circ\text{C} \leq T_A \leq +125^\circ\text{C}$	2.575	2.65		V
Output Voltage Low	$V_{OL}$	$I_L = 1\text{ mA}$ $-40^\circ\text{C} \leq T_A \leq +125^\circ\text{C}$	2.550			V
Output Current	$I_{OUT}$ $\pm I_{SC}$	$V_{OUT} = V_S - 1\text{ V}$		15	100	mV
					125	mV
Closed Loop Output Impedance	$Z_{OUT}$	$f = 200\text{ kHz}$ , $A_V = 1$		50		$\Omega$
<b>POWER SUPPLY</b>						
Power Supply Rejection Ratio	PSRR	$V_S = 2.5\text{ V to } 6\text{ V}$ $-40^\circ\text{C} \leq T_A \leq +125^\circ\text{C}$	65	76		dB
Supply Current/Amplifier	$I_{SY}$	$V_O = 0\text{ V}$	60			dB
		$-40^\circ\text{C} \leq T_A \leq +125^\circ\text{C}$		38	55	$\mu\text{A}$
<b>DYNAMIC PERFORMANCE</b>						
Slew Rate	SR	$R_L = 100\text{ k}\Omega$	0.4	0.75		$\text{V}/\mu\text{s}$
Settling Time	$t_s$	To 0.1% (1 V Step)		5		$\mu\text{s}$
Gain Bandwidth Product	GBP			980		kHz
Phase Margin	$\Phi_O$			63		Degrees
<b>NOISE PERFORMANCE</b>						
Voltage Noise Density	$e_n$	$f = 1\text{ kHz}$		40		$\text{nV}/\sqrt{\text{Hz}}$
		$f = 10\text{ kHz}$		38		$\text{nV}/\sqrt{\text{Hz}}$
Current Noise Density	$i_n$			<0.1		$\text{pA}/\sqrt{\text{Hz}}$

Specifications subject to change without notice.

**ELECTRICAL CHARACTERISTICS** ( $V_S = 3.0\text{ V}$ ,  $V_{CM} = 1.5\text{ V}$ ,  $T_A = 25^\circ\text{C}$  unless otherwise noted)

Parameter	Symbol	Conditions	Min	Typ	Max	Unit
<b>INPUT CHARACTERISTICS</b>						
Offset Voltage	$V_{OS}$	$-40^\circ\text{C} \leq T_A \leq +125^\circ\text{C}$		1	6	mV
Input Bias Current	$I_B$	$-40^\circ\text{C} \leq T_A \leq +125^\circ\text{C}$		4	7	mV
Input Offset Current	$I_{OS}$	$-40^\circ\text{C} \leq T_A \leq +85^\circ\text{C}$			60	pA
		$-40^\circ\text{C} \leq T_A \leq +125^\circ\text{C}$			100	pA
Input Voltage Range	CMRR	$V_{CM} = 0\text{ V to }3\text{ V}$			1,000	pA
		$-40^\circ\text{C} \leq T_A \leq +125^\circ\text{C}$		0.1	30	pA
		$-40^\circ\text{C} \leq T_A \leq +125^\circ\text{C}$			50	pA
Common-Mode Rejection Ratio	CMRR	$V_{CM} = 0\text{ V to }3\text{ V}$	0		3	V
		$-40^\circ\text{C} \leq T_A \leq +125^\circ\text{C}$	40	45		dB
Large Signal Voltage Gain	$A_{VO}$	$R_L = 100\text{ k}\Omega$ , $V_O = 0.5\text{ V to }2.2\text{ V}$	38			dB
		$-40^\circ\text{C} \leq T_A \leq +85^\circ\text{C}$	100	500		V/mV
		$-40^\circ\text{C} \leq T_A \leq +125^\circ\text{C}$	50			V/mV
Offset Voltage Drift	$\Delta V_{OS}/\Delta T$	$-40^\circ\text{C} \leq T_A \leq +125^\circ\text{C}$		2		V/mV
Bias Current Drift	$\Delta I_B/\Delta T$	$-40^\circ\text{C} \leq T_A \leq +125^\circ\text{C}$		4		$\mu\text{V}/^\circ\text{C}$
Offset Current Drift	$\Delta I_{OS}/\Delta T$	$-40^\circ\text{C} \leq T_A \leq +85^\circ\text{C}$		100		$\text{fA}/^\circ\text{C}$
		$-40^\circ\text{C} \leq T_A \leq +125^\circ\text{C}$		2,000		$\text{fA}/^\circ\text{C}$
<b>OUTPUT CHARACTERISTICS</b>						
Output Voltage High	$V_{OH}$	$I_L = 1\text{ mA}$ $-40^\circ\text{C} \leq T_A \leq +125^\circ\text{C}$	2.875	2.955		V
Output Voltage Low	$V_{OL}$	$I_L = 1\text{ mA}$	2.850			V
		$-40^\circ\text{C} \leq T_A \leq +125^\circ\text{C}$		32	100	mV
Output Current	$I_{OUT}$ $\pm I_{SC}$	$V_{OUT} = V_S - 1\text{ V}$		18	125	mV
				$\pm 25$		mA
Closed Loop Output Impedance	$Z_{OUT}$	$f = 200\text{ kHz}$ , $A_V = 1$		50		$\Omega$
<b>POWER SUPPLY</b>						
Power Supply Rejection Ratio	PSRR	$V_S = 2.5\text{ V to }6\text{ V}$ $-40^\circ\text{C} \leq T_A \leq +125^\circ\text{C}$	65	76		dB
Supply Current/Amplifier	$I_{SY}$	$V_O = 0\text{ V}$	60			dB
		$-40^\circ\text{C} \leq T_A \leq +125^\circ\text{C}$		40	60	$\mu\text{A}$
					75	$\mu\text{A}$
<b>DYNAMIC PERFORMANCE</b>						
Slew Rate	SR	$R_L = 100\text{ k}\Omega$	0.4	0.8		V/ $\mu\text{s}$
Settling Time	$t_S$	To 0.01% (1 V Step)		5		$\mu\text{s}$
Gain Bandwidth Product	GBP			980		kHz
Phase Margin	$\Phi_O$			64		Degrees
<b>NOISE PERFORMANCE</b>						
Voltage Noise Density	$e_n$	$f = 1\text{ kHz}$		42		$\text{nV}/\sqrt{\text{Hz}}$
Current Noise Density	$e_n$ $i_n$	$f = 10\text{ kHz}$		38		$\text{nV}/\sqrt{\text{Hz}}$
				<0.1		$\text{pA}/\sqrt{\text{Hz}}$

Specifications subject to change without notice.

# AD8541/AD8542/AD8544—SPECIFICATIONS

## ELECTRICAL CHARACTERISTICS ( $V_S = 5.0\text{ V}$ , $V_{CM} = 2.5\text{ V}$ , $T_A = 25^\circ\text{C}$ unless otherwise noted)

Parameter	Symbol	Conditions	Min	Typ	Max	Unit
<b>INPUT CHARACTERISTICS</b>						
Offset Voltage	$V_{OS}$	$-40^\circ\text{C} \leq T_A \leq +125^\circ\text{C}$		1	6	mV
Input Bias Current	$I_B$	$-40^\circ\text{C} \leq T_A \leq +85^\circ\text{C}$		4	60	pA
		$-40^\circ\text{C} \leq T_A \leq +125^\circ\text{C}$			100	pA
Input Offset Current	$I_{OS}$	$-40^\circ\text{C} \leq T_A \leq +85^\circ\text{C}$		0.1	30	pA
		$-40^\circ\text{C} \leq T_A \leq +125^\circ\text{C}$			50	pA
Input Voltage Range			0		5	V
Common-Mode Rejection Ratio	CMRR	$V_{CM} = 0\text{ V to } 5\text{ V}$	40	48		dB
		$-40^\circ\text{C} \leq T_A \leq +125^\circ\text{C}$	38			dB
Large Signal Voltage Gain	$A_{VO}$	$R_L = 100\text{ k}\Omega$ , $V_O = 0.5\text{ V to } 2.2\text{ V}$	20	40		V/mV
		$-40^\circ\text{C} \leq T_A \leq +85^\circ\text{C}$	10			V/mV
		$-40^\circ\text{C} \leq T_A \leq +125^\circ\text{C}$	2			V/mV
Offset Voltage Drift	$\Delta V_{OS}/\Delta T$	$-40^\circ\text{C} \leq T_A \leq +125^\circ\text{C}$		4		$\mu\text{V}/^\circ\text{C}$
Bias Current Drift	$\Delta I_B/\Delta T$	$-40^\circ\text{C} \leq T_A \leq +85^\circ\text{C}$		100		fA/ $^\circ\text{C}$
		$-40^\circ\text{C} \leq T_A \leq +125^\circ\text{C}$		2,000		fA/ $^\circ\text{C}$
Offset Current Drift	$\Delta I_{OS}/\Delta T$	$-40^\circ\text{C} \leq T_A \leq +125^\circ\text{C}$		25		fA/ $^\circ\text{C}$
<b>OUTPUT CHARACTERISTICS</b>						
Output Voltage High	$V_{OH}$	$I_L = 1\text{ mA}$	4.9	4.965		V
		$-40^\circ\text{C} \leq T_A \leq +125^\circ\text{C}$	4.875			V
Output Voltage Low	$V_{OL}$	$I_L = 1\text{ mA}$		25	100	mV
		$-40^\circ\text{C} \leq T_A \leq +125^\circ\text{C}$			125	mV
Output Current	$I_{OUT}$	$V_{OUT} = V_S - 1\text{ V}$		30		mA
	$\pm I_{SC}$			$\pm 60$		mA
Closed Loop Output Impedance	$Z_{OUT}$	$f = 200\text{ kHz}$ , $A_V = 1$		45		$\Omega$
<b>POWER SUPPLY</b>						
Power Supply Rejection Ratio	PSRR	$V_S = 2.5\text{ V to } 6\text{ V}$	65	76		dB
		$-40^\circ\text{C} \leq T_A \leq +125^\circ\text{C}$	60			dB
Supply Current/Amplifier	$I_{SY}$	$V_O = 0\text{ V}$		45	65	$\mu\text{A}$
		$-40^\circ\text{C} \leq T_A \leq +125^\circ\text{C}$			85	$\mu\text{A}$
<b>DYNAMIC PERFORMANCE</b>						
Slew Rate	SR	$R_L = 100\text{ k}\Omega$ , $C_L = 200\text{ pF}$	0.45	0.92		V/ $\mu\text{s}$
Full-Power Bandwidth	$BW_P$	1% Distortion		70		kHz
Settling Time	$t_S$	To 0.1% (1 V Step)		6		$\mu\text{s}$
Gain Bandwidth Product	GBP			1,000		kHz
Phase Margin	$\Phi_O$			67		Degrees
<b>NOISE PERFORMANCE</b>						
Voltage Noise Density	$e_n$	$f = 1\text{ kHz}$		42		$\text{nV}/\sqrt{\text{Hz}}$
	$e_n$	$f = 10\text{ kHz}$		38		$\text{nV}/\sqrt{\text{Hz}}$
Current Noise Density	$i_n$			<0.1		$\text{pA}/\sqrt{\text{Hz}}$

Specifications subject to change without notice.

# AD8541/AD8542/AD8544

## ABSOLUTE MAXIMUM RATINGS<sup>1</sup>

Supply Voltage ( $V_S$ )	6 V
Input Voltage	GND to $V_S$
Differential Input Voltage <sup>2</sup>	$\pm 6$ V
Storage Temperature Range	$-65^\circ\text{C}$ to $+150^\circ\text{C}$
Operating Temperature Range	$-40^\circ\text{C}$ to $+125^\circ\text{C}$
Junction Temperature Range	$-65^\circ\text{C}$ to $+150^\circ\text{C}$
Lead Temperature Range (Soldering, 60 sec)	$300^\circ\text{C}$

### NOTES

<sup>1</sup>Stresses above those listed under Absolute Maximum Ratings may cause permanent damage to the device. This is a stress rating only; functional operation of the device at these or any other conditions above those listed in the operational sections of this specification is not implied. Exposure to absolute maximum rating conditions for extended periods may affect device reliability.

<sup>2</sup>For supplies less than 6 V, the differential input voltage is equal to  $\pm V_S$ .

## PACKAGE INFORMATION

Package Type	$\theta_{JA}$ *	$\theta_{JC}$	Unit
5-Lead SC70 (KS)	376	126	$^\circ\text{C}/\text{W}$
5-Lead SOT-23 (RT)	230	146	$^\circ\text{C}/\text{W}$
8-Lead SOIC (R)	158	43	$^\circ\text{C}/\text{W}$
8-Lead MSOP (RM)	210	45	$^\circ\text{C}/\text{W}$
8-Lead TSSOP (RU)	240	43	$^\circ\text{C}/\text{W}$
14-Lead SOIC (R)	120	36	$^\circ\text{C}/\text{W}$
14-Lead TSSOP (RU)	240	43	$^\circ\text{C}/\text{W}$

\* $\theta_{JA}$  is specified for worst-case conditions, i.e.,  $q_{JA}$  is specified for device soldered onto a circuit board for surface mount packages.

## ORDERING GUIDE

Model	Temperature Range	Package Description	Package Option	Branding Information
AD8541AKS*	$-40^\circ\text{C}$ to $+125^\circ\text{C}$	5-Lead SC70	KS-5	A4B
AD8541AR	$-40^\circ\text{C}$ to $+125^\circ\text{C}$	8-Lead SOIC	SO-8	
AD8541ART*	$-40^\circ\text{C}$ to $+125^\circ\text{C}$	5-Lead SOT-23	RT-5	A4A
AD8542AR	$-40^\circ\text{C}$ to $+125^\circ\text{C}$	8-Lead SOIC	SO-8	
AD8542ARM*	$-40^\circ\text{C}$ to $+125^\circ\text{C}$	8-Lead MSOP	RM-8	AVA
AD8542ARU*	$-40^\circ\text{C}$ to $+125^\circ\text{C}$	8-Lead TSSOP	RU-8	
AD8544AR	$-40^\circ\text{C}$ to $+125^\circ\text{C}$	14-Lead SOIC	SO-14	
AD8544ARU*	$-40^\circ\text{C}$ to $+125^\circ\text{C}$	14-Lead TSSOP	RU-14	

\*Available in reels only.

## CAUTION

ESD (electrostatic discharge) sensitive device. Electrostatic charges as high as 4000 V readily accumulate on the human body and test equipment and can discharge without detection. Although the AD8541/AD8542/AD8544 features proprietary ESD protection circuitry, permanent damage may occur on devices subjected to high-energy electrostatic discharges. Therefore, proper ESD precautions are recommended to avoid performance degradation or loss of functionality.



# AD8541/AD8542/AD8544—Typical Performance Characteristics

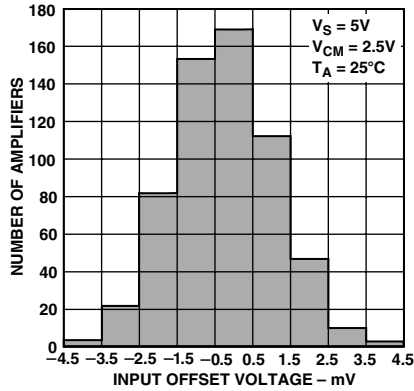

Figure 1. Input Offset Voltage Distribution

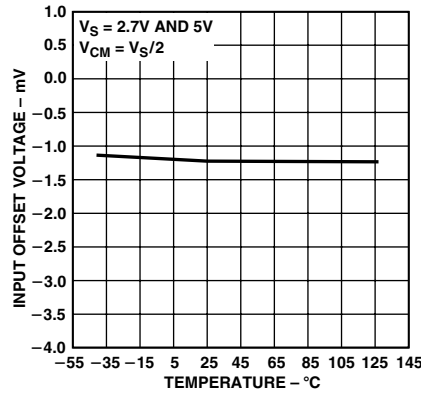

Figure 2. Input Offset Voltage vs. Temperature

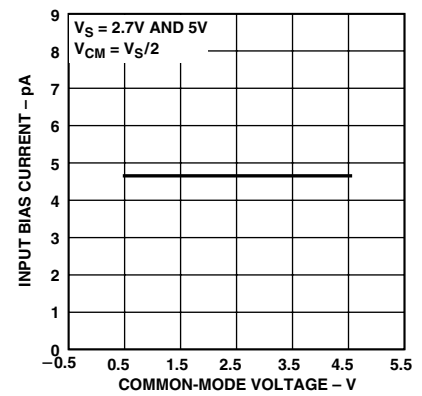

Figure 3. Input Bias Current vs. Common-Mode Voltage

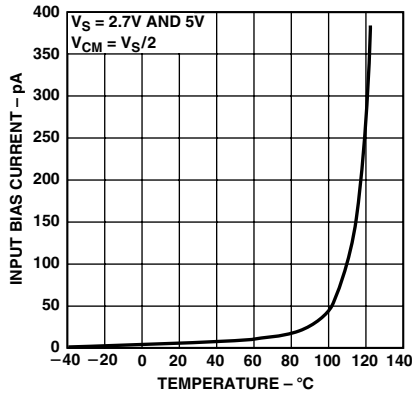

Figure 4. Input Bias Current vs. Temperature

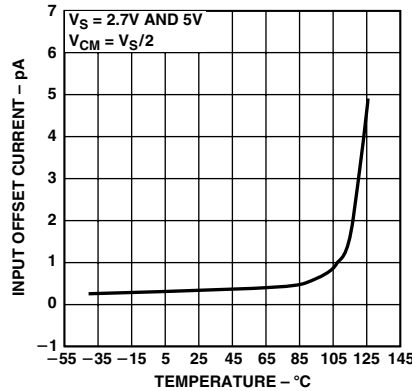

Figure 5. Input Offset Current vs. Temperature

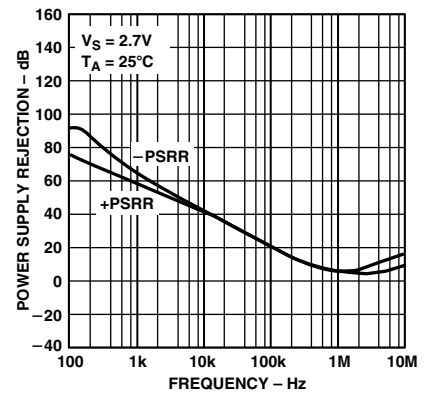

Figure 6. Power Supply Rejection Ratio vs. Frequency

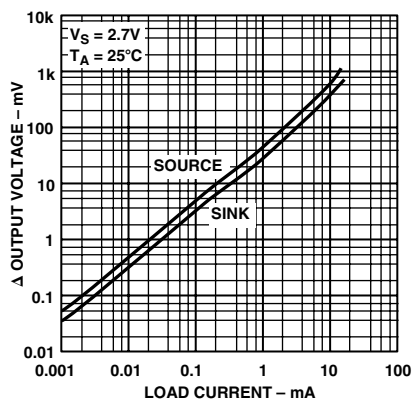

Figure 7. Output Voltage to Supply Rail vs. Load Current

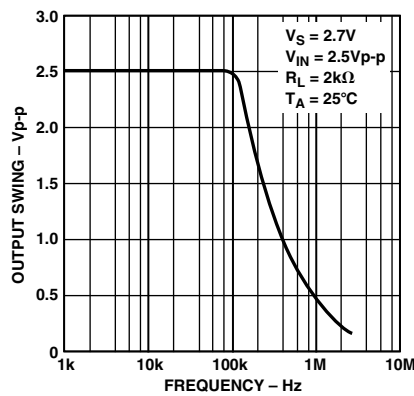

Figure 8. Closed-Loop Output Voltage Swing vs. Frequency

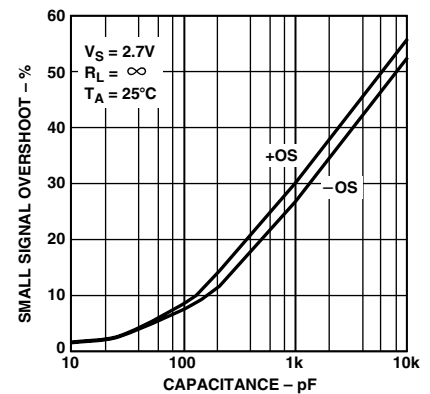

Figure 9. Small Signal Overshoot vs. Load Capacitance

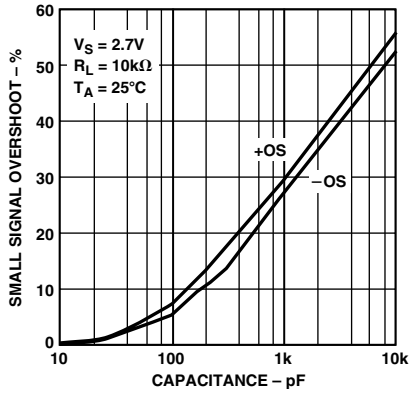

Figure 10. Small Signal Overshoot vs. Load Capacitance

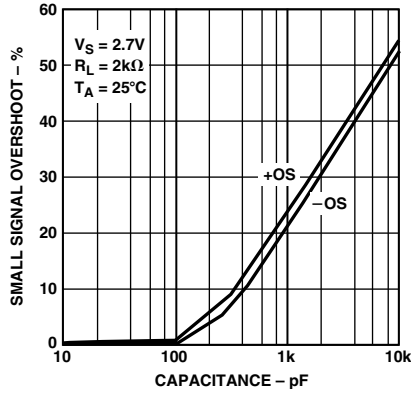

Figure 11. Small Signal Overshoot vs. Load Capacitance

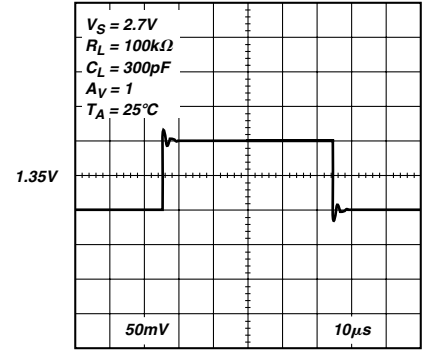

Figure 12. Small Signal Transient Response

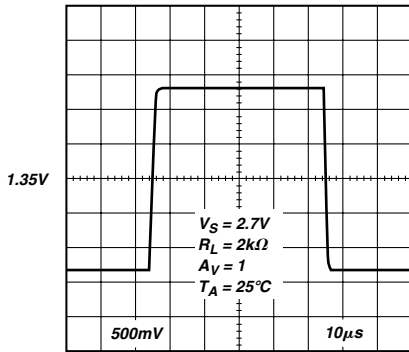

Figure 13. Large Signal Transient Response

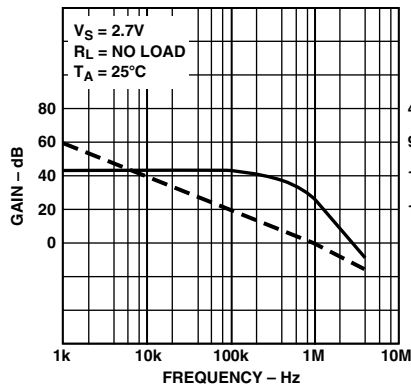

Figure 14. Open-Loop Gain and Phase vs. Frequency

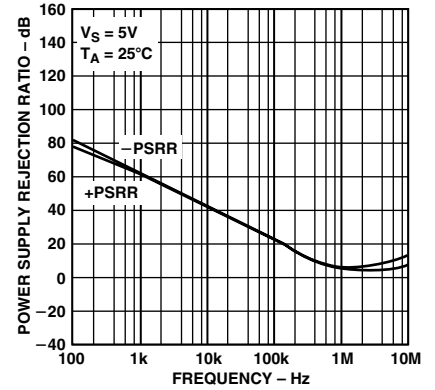

Figure 15. Power Supply Rejection Ratio vs. Frequency

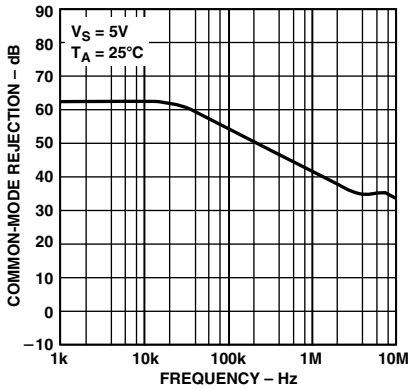

Figure 16. Common-Mode Rejection Ratio vs. Frequency

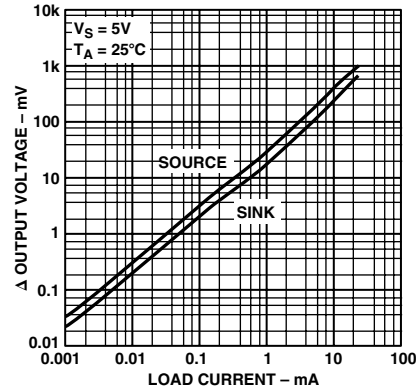

Figure 17. Output Voltage to Supply Rail vs. Frequency

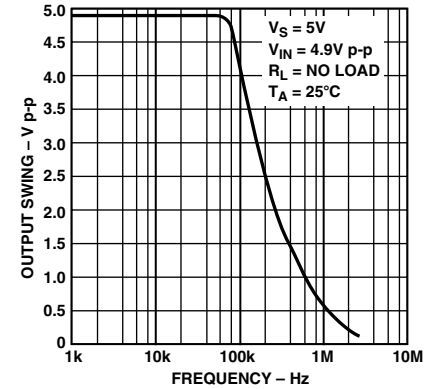

Figure 18. Closed Loop Output Voltage Swing vs. Frequency

# AD8541/AD8542/AD8544

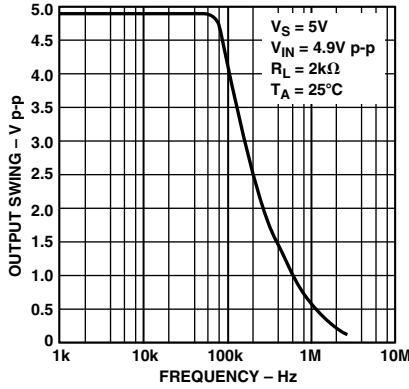

Figure 19. Closed-Loop Output Voltage Swing vs. Frequency

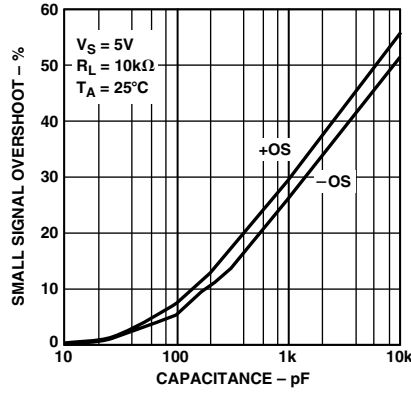

Figure 20. Small Signal Overshoot vs. Load Capacitance

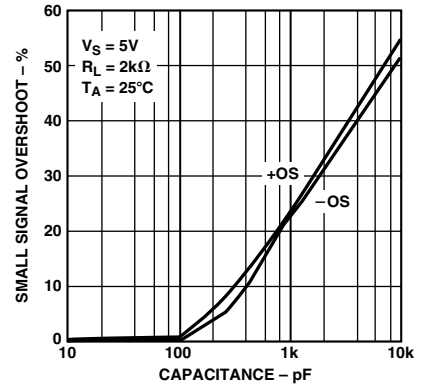

Figure 21. Small Signal Overshoot vs. Load Capacitance

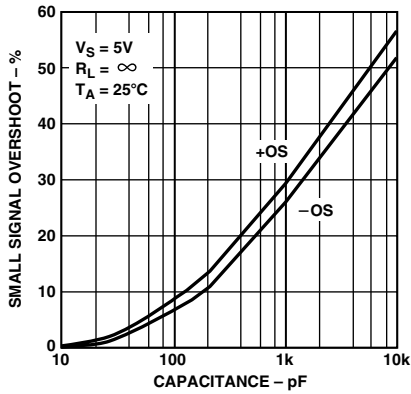

Figure 22. Small Signal Overshoot vs. Load Capacitance

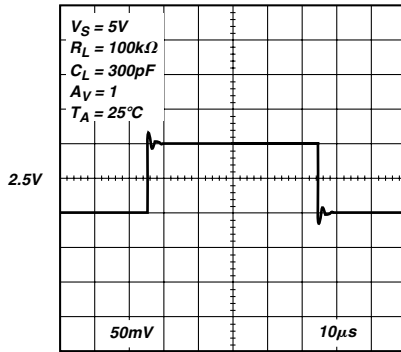

Figure 23. Small Signal Transient Response

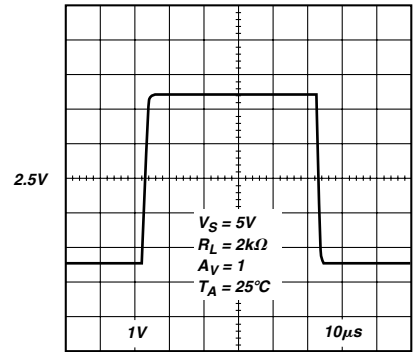

Figure 24. Large Signal Transient Response

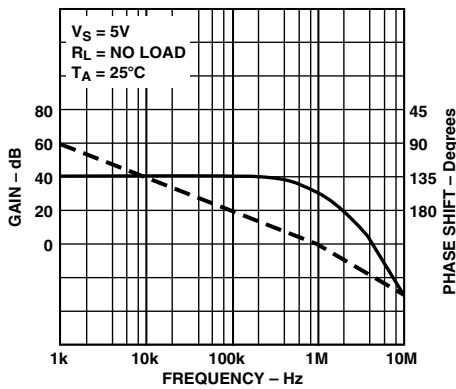

Figure 25. Open-Loop Gain & Phase vs. Frequency

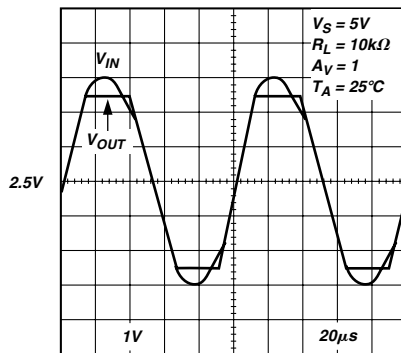

Figure 26. No Phase Reversal

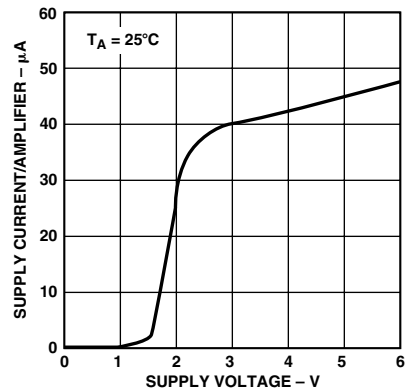

Figure 27. Supply Current per Amplifier vs. Supply Voltage



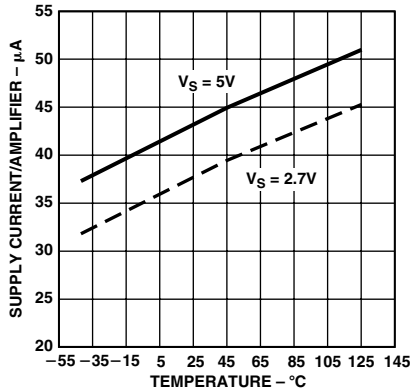

Figure 28. Supply Current per Amplifier vs. Temperature

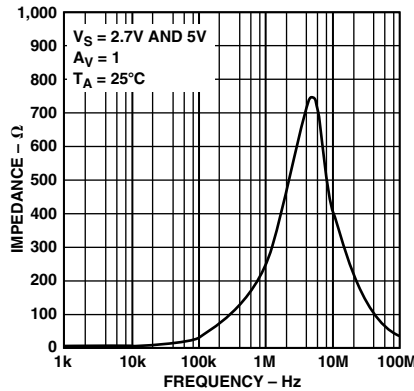

Figure 29. Closed-Loop Output Impedance vs. Frequency

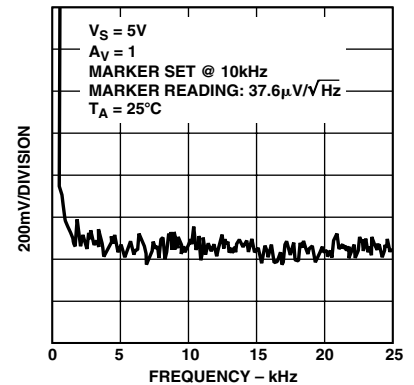

Figure 30. Voltage Noise

## NOTES ON THE AD854x AMPLIFIERS

The AD8541/AD8542/AD8544 amplifiers are improved performance general-purpose operational amplifiers. Performance has been improved over previous amplifiers in several ways.

### Lower Supply Current for 1 MHz Gain Bandwidth

The AD854x series typically uses 45 microamps of current per amplifier. This is much less than the 200  $\mu\text{A}$  to 700  $\mu\text{A}$  used in earlier generation parts with similar performance. This makes the AD854x series a good choice for upgrading portable designs for longer battery life. Alternatively, additional functions and performance can be added at the same current drain.

### Higher Output Current

At 5 V single supply, the short circuit current is typically 60  $\mu\text{A}$ . Even 1 V from the supply rail, the AD854x amplifiers can provide 30 mA, sourcing or sinking.

Sourcing and sinking is strong at lower voltages, with 15 mA available at 2.7 V, and 18 mA at 3.0 V. For even higher output currents, please see the Analog Devices AD8531/AD8532/AD8534 parts, with output currents to 250 mA. Information on these parts is available from your Analog Devices representative, and data sheets are available at the Analog Devices website at [www.analog.com](http://www.analog.com).

### Better Performance at Lower Voltages

The AD854x family parts have been designed to provide better ac performance, at 3.0 V and 2.7 V, than previously available parts. Typical gain-bandwidth product is close to 1 MHz at 2.7 V. Voltage gain at 2.7 V and 3.0 V is typically 500,000. Phase margin is typically over 60°C, making the part easy to use.

## APPLICATIONS

### Notch Filter

The AD8542 has very high open loop gain (especially with supply voltage below 4 V), which makes it useful for active filters of all types. For example, Figure 31 illustrates the AD8542 in the classic Twin-T Notch Filter design. The Twin-T Notch is desired for simplicity, low output impedance and minimal use of op amps. In fact, this notch filter may be designed with only one op amp if Q adjustment is not required. Simply remove U2 as illustrated in Figure 32. However, a major drawback to this circuit topology is ensuring that all the R's and C's closely match. The components must closely match or notch frequency offset and drift will cause

the circuit to no longer attenuate at the ideal notch frequency. To achieve desired performance, 1% or better component tolerances or special component screens are usually required. One method to desensitize the circuit-to-component mismatch is to increase R2 with respect to R1, which lowers Q. A lower Q increases attenuation over a wider frequency range, but reduces attenuation at the peak notch frequency.

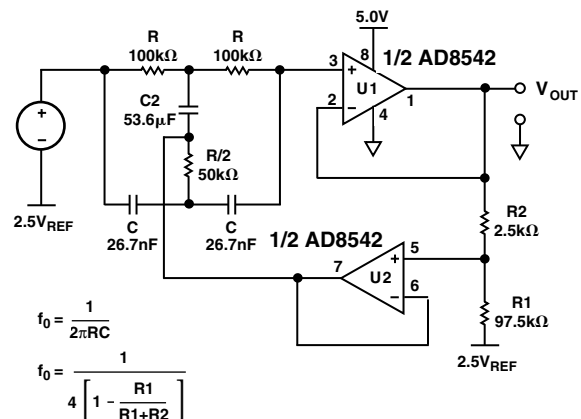

Figure 31. 60 Hz Twin-T Notch Filter,  $Q = 10$

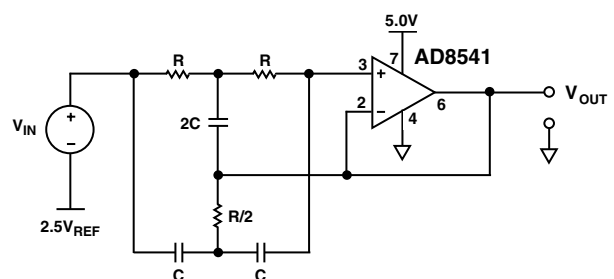

Figure 32. 60 Hz Twin-T Notch Filter,  $Q = \infty$  (Ideal)

Figure 33 diagrams another example of the AD8542 in a notch filter circuit. The FNDR notch filter has several unique features as compared to the Twin-T Notch including: less critical matching requirements; Q is directly proportional to a single resistor R1. While matching component values is still important, it is also much easier and/or less expensive to

# AD8541/AD8542/AD8544

accomplish in the FNDR circuit. For example, the Twin-T Notch uses three capacitors with two unique values, whereas the FNDR circuit uses only two capacitors, which may be of the same value. U3 is simply a buffer that is added to lower the output impedance of the circuit.

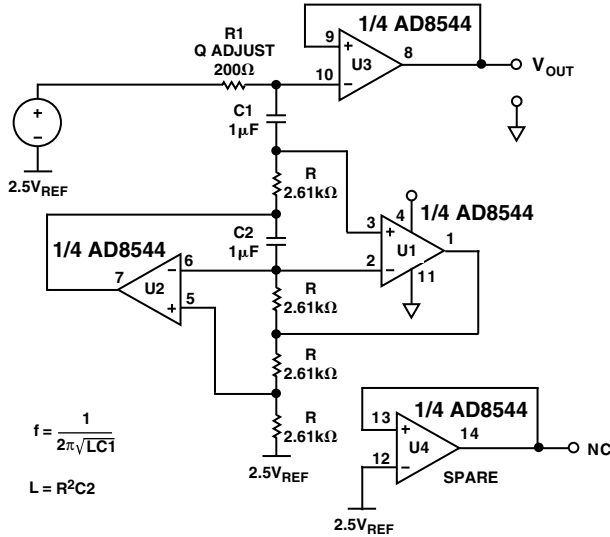

Figure 33. FNDR 60 Hz Notch Filter with Output Buffer

## Comparator Function

A comparator function is a common application for a spare op amp in a quad package. Figure 34 illustrates 1/4 of the AD8544 as a comparator in a standard overload detection application. Unlike so many op amps, the AD854x family can double as comparator because this op amp family has rail-to-rail differential input range, rail-to-rail output, and a great speed vs. power ratio. R2 is used to introduce hysteresis. The AD854x when used as comparators have 5 μs propagation delay @ 5 V and 5 μs overload recovery time.

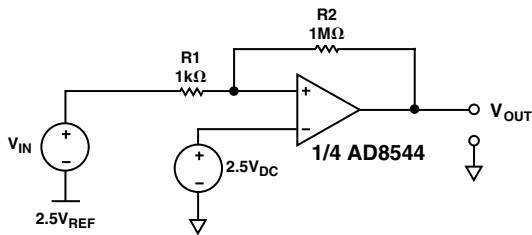

Figure 34. The AD854x Comparator Application—Overload Detector

## Photodiode Application

The AD854x family has very high impedance with input bias current typically around 4 pA. This characteristic allows the AD854x op amps to be used in photodiode applications and other applications that require high input impedance. Note that the AD854x has significant voltage offset, which can be removed by capacitive coupling or software calibration.

Figure 35, illustrates a photodiode or current measurement application. The feedback resistor is limited to 10 MΩ to avoid excessive output offset. Also note that a resistor is not needed on the noninverting input to cancel bias current offset, because the bias current related output offset is not significant when compared to the voltage offset contribution. For the best performance follow the standard high impedance layout techniques including: shield circuit, clean circuit board, put a trace connected to the noninverting input around the inverting input, and use separate analog and digital power supplies.

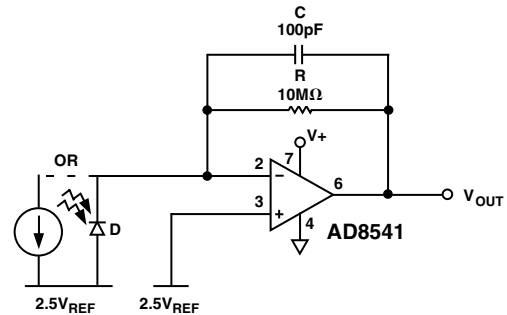

Figure 35. High Input Impedance Application—Photodiode Amplifier

```

* AD8542 SPICE Macro-model Typical Values
* 6/98, Ver. 1
* TAM / ADSC
*
* Copyright 1998 by Analog Devices
*
* Refer to "README.DOC" file for License State-
ment. Use of this
* model indicates your acceptance of the terms
and provisions in
* the License Statement.
*
* Node Assignments
*
*           noninverting input
*           |   inverting input
*           |   |   positive supply
*           |   |   |   negative supply
*           |   |   |   |   output
*           |   |   |   |   |
*           |   |   |   |   |
* .SUBCKT AD8542      1   2   99  50  45
*
* INPUT STAGE
*
M1  4   1   8   8  PIX L=0.6E-6 W=16E-6
M2  6   7   8   8  PIX L=0.6E-6 W=16E-6
M3  11  1  10  10  NIX L=0.6E-6 W=16E-6
M4  12  7  10  10  NIX L=0.6E-6 W=16E-6
RC1  4  50  20E3
RC2  6  50  20E3
RC3  99 11  20E3
RC4  99 12  20E3
C1   4   6  1.5E-12
C2  11  12  1.5E-12
I1  99   8  1E-5
I2  10  50  1E-5
V1  99   9  0.2
V2  13  50  0.2
D1   8   9  DX
D2  13  10  DX
EOS  7   2  POLY(3) (22,98) (73,98) (81,0) 1E-3 1 1
IOS  1   2  2.5E-12
*
* CMRR 64dB, ZERO AT 20kHz
*
ECM1 21 98 POLY(2) (1,98) (2,98) 0 .5 .5
RCM1 21 22 79.6E3
CCM1 21 22 100E-12
RCM2 22 98 50
*
* PSRR=90dB, ZERO AT 200Hz
*
RPS1 70   0 1E6
RPS2 71   0 1E6
CPS1 99 70 1E-5
CPS2 50 71 1E-5
EPSY 98 72 POLY(2) (70,0) (0,71) 0 1 1
RPS3 72 73 1.59E6
CPS3 72 73 500E-12
RPS4 73 98 25
*

```

```

* VOLTAGE NOISE REFERENCE OF 35nV/rt(Hz)
*
VN1 80 0 0
RN1 80 0 16.45E-3
HN  81 0 VN1 35
RN2 81 0 1
*
* INTERNAL VOLTAGE REFERENCE
*
VFIX 90 98 DC 1
S1   90 91 (50,99) VSY_SWITCH
VSN1 91 92 DC 0
RSY  92 98 1E3
EREF 98  0 POLY(2) (99,0) (50,0) 0 .5 .5
GSY  99 50 POLY(1) (99,50) 0 3.7E-6
*
* ADAPTIVE GAIN STAGE
* AT Vsy>+4.2, AVol=45 V/mv
* AT Vsy<+3.8, AVol=450 V/mv
*
G1   98 30 POLY(2) (4,6) (11,12) 0 2.5E-5 2.5E-5
VR1  30 31 DC 0
H1   31 98 POLY(2) VR1 VSN1 0 5.45E6 0 0 49.05E9
CF   45 30 10E-12
D3   30 99 DX
D4   50 30 DX
*
* OUTPUT STAGE
*
M5   45 46 99 99 POX L=0.6E-6 W=375E-6
M6   45 47 50 50 NOX L=0.6E-6 W=500E-6
EG1  99 46 POLY(1) (98,30) 1.05 1
EG2  47 50 POLY(1) (30,98) 1.04 1
*
* MODELS
*
.MODEL POX PMOS (LEVEL=2,KP=20E-6,VTO=-
+1,LAMBDA=0.067)
.MODEL NOX NMOS (LEVEL=2,KP=20E-
+6,VTO=1,LAMBDA=0.067)
.MODEL PIX PMOS (LEVEL=2,KP=20E-6,VTO=-
+0.7,LAMBDA=0.01,KF=1E-31)
.MODEL NIX NMOS (LEVEL=2,KP=20E-
+6,VTO=0.7,LAMBDA=0.01,KF=1E-31)
.MODEL DX D(IS=1E-14)
.MODEL VSY_SWITCH VSWITCH(ROFF=100E3,RON=1,VOFF=-
+4.2,VON=-3.5)
.ENDS AD8542

```

# AD8541/AD8542/AD8544

## OUTLINE DIMENSIONS

Dimensions shown in inches and (mm).

**8-Lead TSSOP  
(RU-08)**

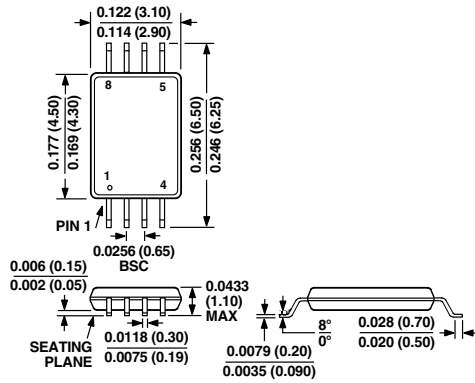

**14-Lead TSSOP  
(RU-14)**

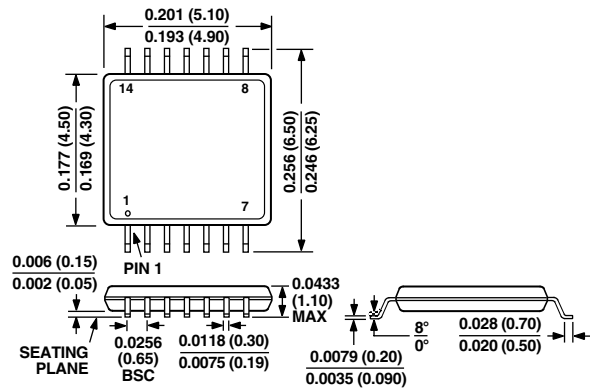

**8-Lead SOIC  
(SO-8)**

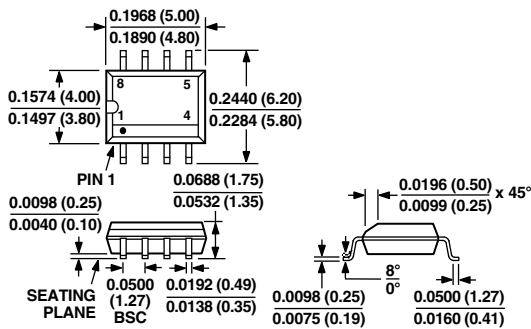

**14-Lead SOIC  
(SO-14)**

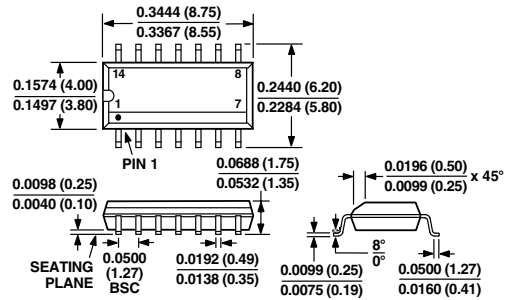

**8-Lead MSOP  
(RM-8)**

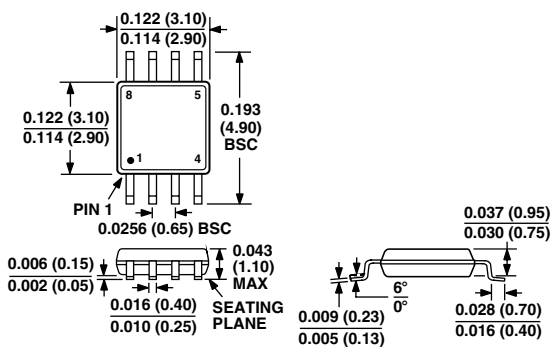

**5-Lead SOT-23  
(RT Suffix)**

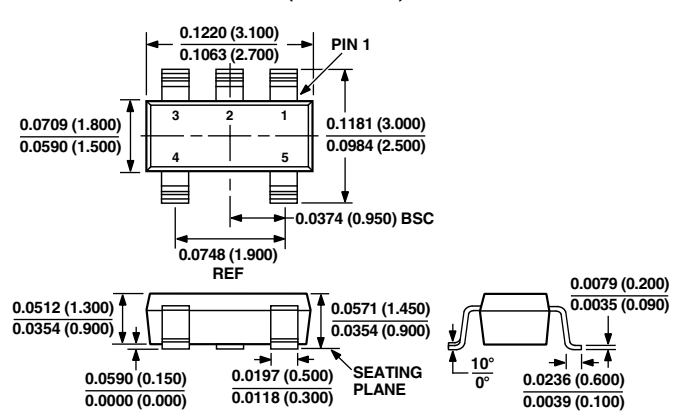

**5-Lead SC70  
(KS-5)**

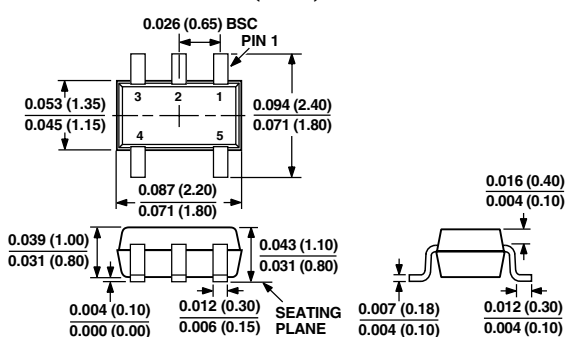

NOTE:  
PACKAGE OUTLINE INCLUSIVE AS SOLDER PLATING.