

THYRISTORS

5P4M, 5P5M, 5P6M

5 A (8 A_{r.m.s.}) THYRISTOR

PACKAGE DIMENSIONS in millimeters

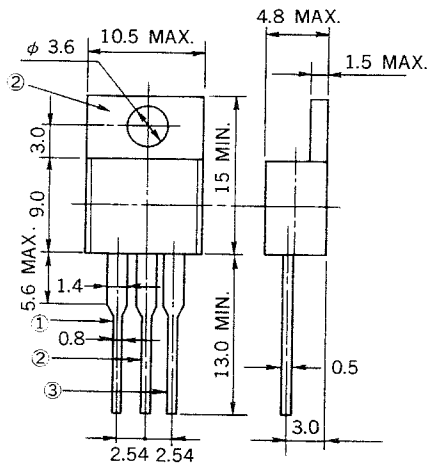

Pin Connection

- ① Cathode
- ② Anode
- ③ Gate

The 5P4M to 5P6M are a P gate all diffused mold type Thyristor granted 5Amp On-state Average Current ($T_C=103^\circ\text{C}$)

FEATURES

- Easy installation by TO-220 AB package.
- 80 A surge current.
- High Voltage.
 - : $V_{\text{DRM}}, V_{\text{RRM}} = 400\text{ V}$ (5P4M)
 - : $V_{\text{DRM}}, V_{\text{RRM}} = 500\text{ V}$ (5P5M)
 - : $V_{\text{DRM}}, V_{\text{RRM}} = 600\text{ V}$ (5P6M)

APPLICATIONS

- Motor speed control for household appliance.
- Temperature control for heater and constant temperature box.
- Constant voltage power source and battery charger.
- Automotive application such as regulator.
- Various solid state relay etc.

MAXIMUM RATINGS

CHARACTERISTIC	SYMBOL	5P4M	5P5M	5P6M	UNIT	NOTE
Non-Repetitive Peak Reverse Voltage	V_{RSM}	500	600	700	V	
Non-Repetitive Peak Off-State Voltage	V_{DSM}	500	600	700	V	
Repetitive Peak Reverse Voltage	V_{RRM}	400	500	600	V	
Repetitive Peak Off-State Voltage	V_{DRM}	400	500	600	V	
Average On-State Current	$I_{T(AV)}$	5 ($T_c = 103^\circ\text{C}$, $\theta = 180^\circ$ Single phase half wave)			A	See Fig. 5
Surge On-State Current	I_{TSM}	80			A	See Fig. 2
Fusing Current	$\int i_T^2 dt$	28 ($1\text{ ms} \leq t \leq 10\text{ ms}$)			A^2s	
Peak Gate Power Dissipation	P_{GM}	5 ($f \geq 50\text{ Hz}$, Duty $\leq 10\%$)			W	See Fig. 3
Average Gate Power Dissipation	$P_{G(AV)}$	0.5			W	
Peak Gate Forward Current	I_{FGM}	2 ($f \geq 50\text{ Hz}$, Duty $\leq 10\%$)			A	
Peak Gate Reverse Voltage	V_{RGM}	10			V	
Junction Temperature	T_j	-40 to +125			$^\circ\text{C}$	
Storage Temperature	T_{stg}	-40 to +150			$^\circ\text{C}$	
Weight		2			g	

ELECTRICAL CHARACTERISTICS ($T_j = 25^\circ\text{C}$)

CHARACTERISTIC	SYMBOL	CONDITION	MIN.	TYP.	MAX.	UNIT	NOTE
Repetitive Peak Reverse Current	I_{RRM}	$V_{RM} = V_{RRM}$, $T_j = 125^\circ\text{C}$	—	—	2	mA	
Repetitive Peak Off-State Current	I_{DRM}	$V_{DM} = V_{DRM}$, $T_j = 125^\circ\text{C}$	—	—	2	mA	
On-State Voltage	V_{TM}	$I_{TM} = 10\text{ A}$	—	—	1.4	V	See Fig. 1
Gate-Trigger Current	I_{GT}	$V_{DM} = 6\text{ V}$, $R_L = 100\ \Omega$	—	—	10	mA	See Fig. 3
Gate-Trigger Voltage	V_{GT}	$V_{DM} = 6\text{ V}$, $R_L = 100\ \Omega$	—	—	1.5	V	
Gate Non-Trigger Voltage	V_{GD}	$V_{DM} = 1/2 V_{DRM}$, $T_j = 125^\circ\text{C}$	0.2	—	—	V	
Critical Rate of Rise of Off-State Voltage	dv/dt	$V_{DM} = V_{DRM}$, $T_j = 125^\circ\text{C}$	—	40	—	$\text{V}/\mu\text{s}$	
Holding Current	I_H	$V_D = 24\text{ V}$	—	10	—	mA	
Circuit Commuted Turn-Off Time	t_q	$I_{TM} = 5\text{ A}$, $V_R \geq 25\text{ V}$ $V_{DM} = 2/3 V_{DRM}$, $di/dt = 15\text{ A}/\mu\text{s}$ $dv/dt = 10\text{ V}/\mu\text{s}$, $T_j = 125^\circ\text{C}$	—	80	—	μs	
Thermal Resistance	R_{th}	Junction to case	—	—	3	$^\circ\text{C}/\text{W}$	See Fig. 7

Fig. 1 i_T-v_T CHARACTERISTIC

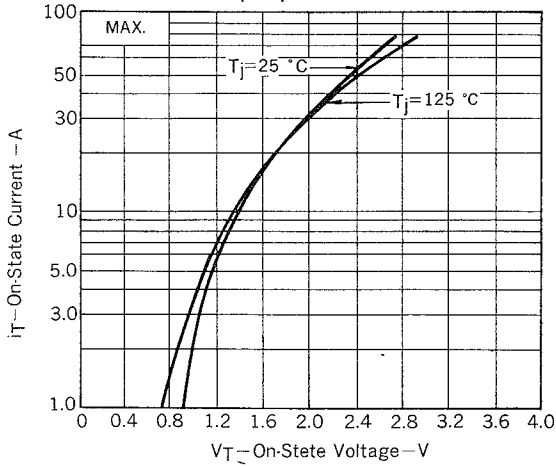

Fig. 2 I_{TSM} RATING

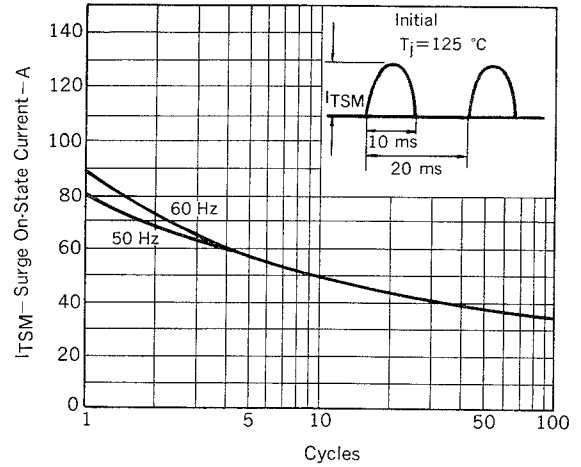

Fig. 3 GATE CHARACTERISTIC

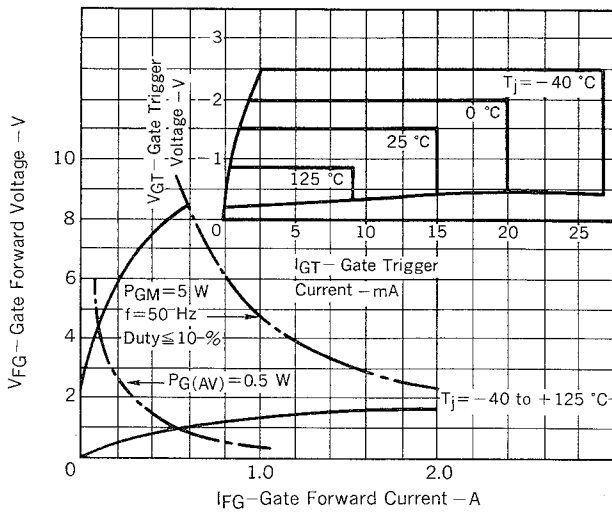

Fig. 4 $P_T(I_{T(AV)})$ CHARACTERISTIC

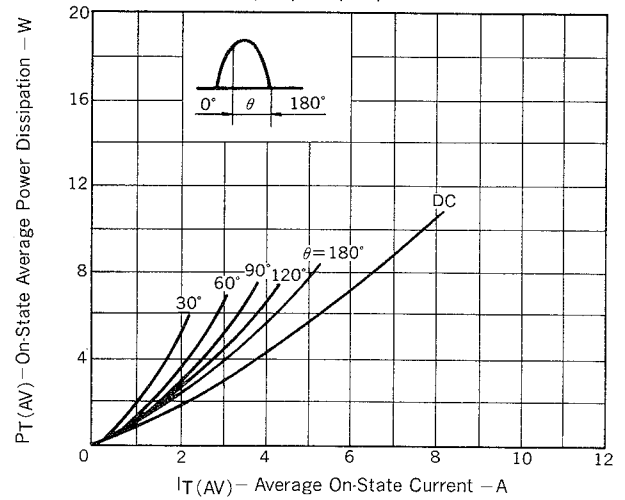

Fig. 5 $T_c-I_{T(AV)}$ RATING

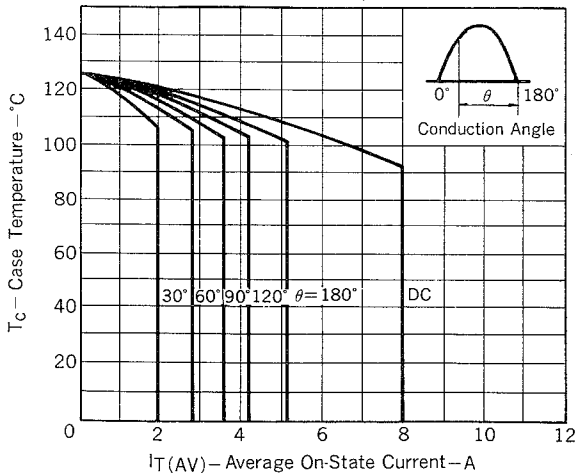
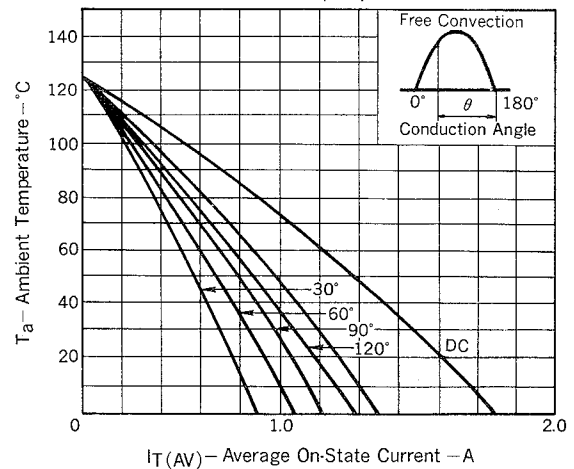
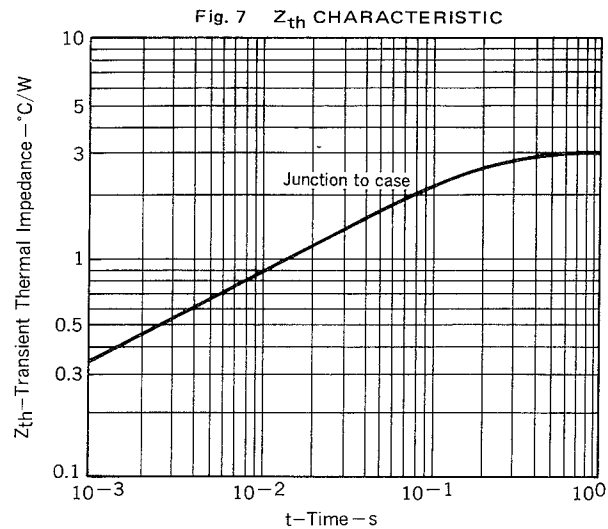

Fig. 6 $T_a-I_{T(AV)}$ RATING





NOTICE FOR INSTALLATION

1. Electrode leads are not granted to be bent because of wet-proof. However it is required inevitably that a mechanical stress should not be put on mold case. Fix tightly between the mold case and the area to be formed or dent.
2. Electrode leads are not granted to be bent more than twice over 90° and avoid the bending within 1.5 mm from the neck of the mold case.
3. The surface of heat sink for thermal radiator is to be smooth without any foreign matter.
4. Suitable torque value is around 3kg-cm.

NEC Corporation

INTERNATIONAL ELECTRON DEVICES DIV.
 SUMITOMO MITA Building, 37-8,
 Shiba Gochome, Minato-ku, Tokyo 108, Japan
 Tel: Tokyo 456-3111
 Telex Address: NECTOK J22686
 Cable Address: NEC TOKYO

SC-1030
 JAN.-10-85M
 Printed in Japan