



Mono and Colour Digital Video CMOS Image Sensors

The VV5410/VV6410 are multi format digital output imaging devices based on STMicroelectronics's unique CMOS sensor technology. Both sensors require minimal support circuitry.

VV5410 (monochrome) and VV6410 (colourised) produce digital video output. The video streams from both devices contain embedded control data that can be used to enable frame grabbing applications as well as providing input data for the external exposure controller.

The pixel array in VV6410 is coated with a Bayer colour pattern. This colourised sensor can interface to a range of STMicroelectronics co-processors. A chipset comprising VV6410 and STV0657 will output 8bit YUV or RGB digital video. A USB camera can be realised by partnering VV6410 with STV0672. Finally a high quality digital stills camera can be produced by operating VV6410 with STV0680B-001. Please contact STMicroelectronics for ordering information on all of these products.

Both VV5410 and VV6410 are initialised in a power saving mode and must be enabled via I2C control before they can produce video. The I2C allows the master coprocessor to reconfigure the device and control exposure and gain settings.

USB systems are catered for with an ultra low power, pin driven, suspend mode.

The on board regulator can supply sufficient current drive to power external components, (e.g. the video coprocessor).

Functional block diagram

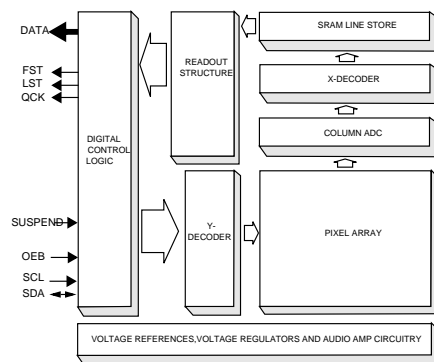

Key Features

- 3.3V operation
- Multiple video formats available
- Pan tilt image feature
- Sub sampled image full FOV feature
- On board 10 bit ADC
- On board voltage regulator
- Low power suspend mode for USB systems
- Automatic black and dark calibration
- On board audio amplifier
- I2C communications

Applications

- PC camera
- Personal digital assistant
- Mobile video phones
- Digital stills cameras

Specifications

Effective image sizes after colour processing	352 x 288 (CIF,PAL) 176 x 144 (QCIF)
Pixel resolution	up to 356 x 292
Pixel size	7.5µm x 6.9µm
Array size	2.73mm x 2.04mm
Exposure control	+81dB
Analogue gain	+12dB (recommended max)
SNR	c.56dB
Random Noise	1.17mV
Sensitivity (Green channel)	2.1V/lux.sec
Dark Current	46mV/sec
VFPN	1.2mV
Supply voltage	3.0V- 6.0V DC +/- 10%
Supply current	26.2mA (max,CIF @30fps) 85µA (suspend mode)
Operating temperature (ambient)	0°C - 40°C
Package type	36pin CLCC

Table of Contents

1. Document Revision History	4
2. Introduction	5
2.1 Overview	5
2.2 Exposure Control.....	5
2.3 Digital Interface	5
2.4 Other Features	7
3. Operating Modes	9
3.1 Video Timing	9
3.2 Pixel Array	10
3.3 X-offset and Y-offset.....	11
3.4 QCIF Output Modes	16
4. Black Offset Cancellation.....	18
5. Dark Offset Cancellation.....	20
6. Exposure Control	21
7. Timed Serial Interface Parameters	24
8. Digital Video Interface Format	27
8.1 General description	27
8.2 Embedded control data	28
8.3 Video timing reference and status/configuration data	31
8.4 Detection of sensor using data bus state	48
8.5 Resetting the Sensor Via the Serial Interface	48
8.6 Resetting the Sensor Via the RESETB pin	48
8.7 Resynchronising the Sensor Via the RESETB pin configured as SINB	48
8.8 Power-up, Low-power and Sleep modes	50
8.9 Suspend mode	52
8.10 Data Qualification Clock, QCK	52
9. Serial Control Bus	60
9.1 General Description.....	60
9.2 Serial Communication Protocol	60
9.3 Data Format	60
9.4 Message Interpretation.....	61
9.5 The Programmers Model.....	61
9.6 Types of messages	82
9.6 Types of messages	82
9.7 Serial Interface Timing	85
10. Clock Signal.....	86
11. Other Features.....	87

11.1	Audio Amplifier	87
11.2	Voltage Regulators	89
11.3	Valid Supply Voltage Configurations	89
11.4	Programmable Pins	91
12.	Characterisation Details	92
12.1	VV5410/VV6410 AC/DC Specification	92
12.2	VV5410/VV6410 Optical Characterisation Data	92
12.3	VV5410/VV6410 Power Consumption	94
12.4	Digital Input Pad Pull-up and Pull-down Strengths	94
13.	Pixel Defect Specification	95
13.1	Pixel Fault Definitions	95
13.2	Stuck at White Pixel Fault	95
13.3	Stuck at Black Pixel Fault	95
13.4	Column / Row Faults	95
13.5	Image Array Blemishes	96
14.	Pinout and pin descriptions	98
14.1	36pin CLCC Pinout Map	98
15.	Package Details (36pin CLCC)	101
16.	Recommended VV5410/6410 support circuit	102
17.	Evaluation kits (EVK's)	103
18.	Ordering details	104

1. Document Revision History

Revision	Date	Comments
1.0	13/06/2000	<ul style="list-style-type: none">• Original release
2.0	06/07/2000	<ul style="list-style-type: none">• Package drawing and pin description updated• Optical characterisation data added• Audio description extended• Pixel defect specification added• Product numbering updated• Reference design for BGA packaged 410 added• Gain ceiling recommendation
2.1	04/09/2000	<ul style="list-style-type: none">• Remove all reference to BGA package option
3.0	28/09/2000	<ul style="list-style-type: none">• Product maturity moves to Mat29 therefore d/s moves to Release3.0

Table 1 : Document Revision History

2. Introduction

2.1 Overview

VV5410/VV6410 is a CIF format CMOS image sensor. The VV5410 sensor is the basic monochrome device and VV6410 is the colourised variant. The operation of VV5410 and VV6410 is very similar but any differences will be identified and explained.

VV6410 can output digital colourised pixel data at frame and line rates compatible with either NTSC or PAL video standards. VV5410 and VV6410 contain the same basic video timing modes. Table 2 summarises these video modes.

The various operating modes are detailed in Section 3.

Important: VV5410 and VV6410's output video data stream only contains raw data. A master co-processor is required to generate a video waveform that can be displayed on a VDU

Mode	Input Clock (MHz) ^{Note}	System Clock Divisor	Image Size	Line Time (µs)	Lines per Frame	Frame Rate (fps)
QCIF - 25 fps	8.00	8	180 x 148	250.00	160	25.00000
QCIF - 30 fps	8.00	8	180 x 148	208.00	160	30.04807
QCIF - 60 fps	16.00	8	180 x 148	104.00	160	60.09614
CIF - 25 fps	16.00	4	356 x 292	125.00	320	25.00000
CIF - 30 fps	16.00	4	356 x 292	104.00	320	30.04807
NTSC (3.2 fsc)	28.636360 / 2.5	2	306 x 244	63.555564	525	29.97003
PAL (3.2 fsc)	35.46895 / 2.5	2	356 x 292	63.999639	625	25.00014

Table 2 : Video Modes

Note: The user can also provide a 24 MHz clock, rather than a 16 MHz clock, for the QCIF-60fps, CIF-25fps and CIF-30fps modes, which the sensor then internally divides by 1.5, (see data_format[22]), to give an effective input clock frequency of 16 MHz.

2.2 Exposure Control

VV5410/VV6410 does not include any form of automatic exposure and/or gain control. Thus to produce a correctly exposed image the integration period for the pixels, in the sensor array, an exposure control algorithm must be implemented externally. The new exposure values are written to the sensor via the serial interface.

2.3 Digital Interface

The sensor's offers a very flexible digital interface, the main components of which are listed below:

1. A tri-stateable 5-wire data bus (D[4:0]) for sending both video data and embedded timing references.
2. 4-wire and 8-wire data bus alternatives available. If the 8-wire option is selected then the FST/LST pins are reconfigured to output data information.
3. A data qualification clock, QCK, which can be programmable via the serial interface to behave in a number of different ways (Tri-stateable).
4. A line start signal, LST (Tri-stateable).
5. A frame start signal, FST (Tri-stateable).
6. OEB tri-states all 5 data bus lines, D[4:0], the qualification clock, QCK, LST, FST and D[7].
7. A 2-wire serial interface (SDA,SCL) for controlling and setting up the device.

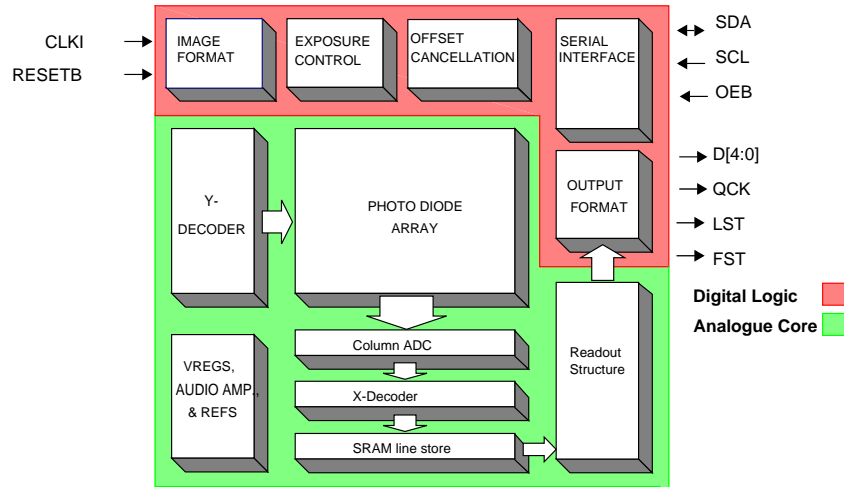

Figure 1 : Block Diagram of VV5410/VV6410 Image Sensor (5-wire output)

2.3.1 Digital Data Bus

Along with the pixel data, codes representing the start and end of fields and the start and end of lines are embedded within the video data stream to allow a co-processor to synchronise with video data the camera module is generating. Section 8. defines the format for the output video data stream.

2.3.2 Frame Grabber Control Signals

To complement the embedded control sequences the data qualification clock (QCK), the line start signal (LST) and the field start signal (FST) signals can be independently set-up as follows:

1. Disabled
2. Free-running.
3. Qualify only the control sequences and the pixel data.
4. Qualify the pixel data only

There is also the choice of two different QCK frequencies where one is twice the frequency of the other.

1. Fast QCK: the falling edge of the clock qualifies every 8, 5 or 4 bit blocks of data that makes up a pixel value.
2. Slow QCK: the rising edge qualifies 1st, 3rd, 5th, etc. blocks of data that make up a pixel value while the falling edge qualifies the 2nd, 4th, 6th etc. blocks of data. For example in 4-wire mode the rising edge of the clock qualifies the most significant nibbles while the falling edge of the clock qualifies the least significant nibbles.

2.3.3 2-wire Serial Interface

The 2-wire serial interface provides complete control over sensor setup and operation. Two serial interface broadcast addresses are supported. One allows all sensors to be written to in parallel while the other allows all sensors and co-processors to be written to in parallel.

Section 9. defines the serial interface communications protocol and the register map of all the locations which can be accessed via the serial interface.

2.3.4 Sensor/Co-processor Interface Options

There are 3 main ways of interfacing to the VV5410/VV6410 sensor based on the above signals:

1. The colour co-processor supplies the sensor clock, CLKI, and uses the embedded control sequences to synchronise with the frame and line level timings. Thus the host and sensor are running off derivatives of the same fundamental clock. To allow the co-processor to determine the best sampling position of the video data, during its power-up sequence the sensor outputs a 101010... sequence on each of its data bus lines for the host to lock on to.

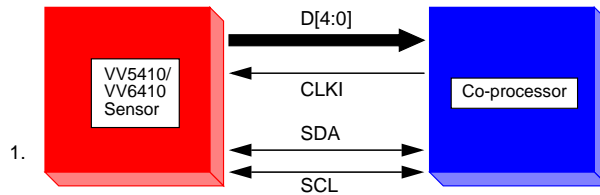

2. The colour co-processor supplies the sensor clock, CLKI, and uses a free-running QCK supplied by the sensor to sample the incoming video data stream. The embedded control sequences are used to synchronise the frame and line level timings.

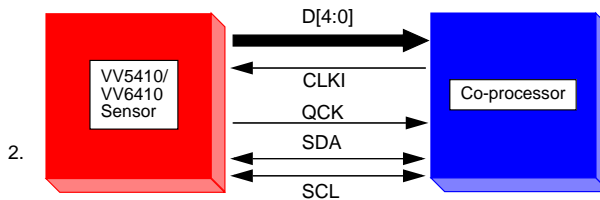

3. The colour co-processor supplies the sensor clock, CLKI, and uses FST, LST and the data only mode for QCK to synchronise to the incoming video data. Primarily intended for interfacing to frame grabbers.

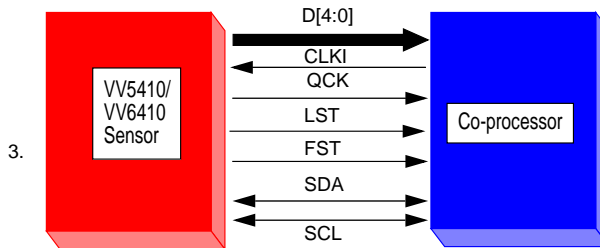

2.4 Other Features

2.4.1 Audio Amplifier

Pins AIN and AOUTP & AOUTN are the input and outputs respectively for an audio amplifier.

2.4.2 Voltage Regulator

The on-chip voltage regulator requires only a few external components to form a fully functional voltage regulator to 3.3V.

2.4.3 Serial Interface Programmable Pins

The FST and QCK pins are re-configurable to follow the state of 2-bits in a serial register. The user could then use these control bits to control a peripheral device, a motor or shutter mechanism for example.

3. Operating Modes

3.1 Video Timing

The video format mode on power-up is CIF 30fps by default. After power-up the mode can be changed by a serial interface to write to the *video_timing* register. The frame/field rate is also programmable via the serial interface. Bit [3] of serial register [16] selects between 30 and 25 frames per second for the CIF modes and 60/50 fields per second for the Digital and Analog Timing modes. Please note that the sensor can exit low power in ANY of the available video modes.

The number of video lines in each frame is the same (320) for both the CIF modes. The slower frame rate (25 fps) is implemented by simply extending the line period from 416 pixel periods to 500 pixel periods.

Table 3 details the setup for each of the video timing modes. A serial write to serial register [16] will force the contents of other registers in the serial interface to change to the appropriate values, regardless of their present state. If for example a different data output mode is required than the default for a particular video mode, a write to the appropriate register after the mode has changed will restore the desired value.

Video Mode	Clock (MHz)	System Clock Divisor	Video Data	Line Length	Field Length	Data Output Mode
PAL (3.2 fsc)	28.636360 / 2.5	2	356 x 292	454	312/313	5-wire
NTSC (3.2 fsc)	35.46895 / 2.5	2	306 x 244	364	262/263	5-wire
CIF - 25 fps	16.0	4	356 x 292	500	320	5-wire
CIF - 30 fps	16.0	4	356 x 292	416	320	5-wire
QCIF - 25 fps	8.0	8	180 x 148	250	160	5-wire
QCIF - 30 fps	8.0	8	180 x 148	208	160	5-wire
QCIF - 60 fps	16.0	8	180 x 148	208	160	5-wire

Table 3 : Video Timing Modes

3.1.1 Arbitration registers

When the operating video mode is changed a number of serial registers are forced into new states. The complete list is as follows:

Arbitrated feature	Video mode selected/value automatically programmed							
	PAL	NTSC	CIF 25fps	CIF 30fps	PTQCIF 25fps	PTQCIF 30fps	SSQCIF 25fps	SSQCIF 30fps
line length	453	363	499	415	249	207	249	207
field length	311	261	319	319	159	159	159	159
system clock division	2	2	4	4	8	8	8	8
free running qck ^{note1}	yes	yes	no	no	no	no	no	no
extra black lines ^{note2}	yes	yes	no	no	no	no	no	no

Table 4 : Arbitration registers



note1: The free running qclk, slow by default, is enabled by writing 8'h04 to serial register [20].

note2: The contents of the extra black lines are enabled on to the data bus by setting bit [5] of serial register [17]. If bit [0] of serial register [24] is reset, indicating that the preferred coprocessor device is not the VP3 device, (a STMicroelectronics coprocessor), then the extra black lines are enabled by default regardless of the basic video mode selected.

The registers that control the image position within the pixel array and also the order in which the pixels are read out have not been included in the table as their values are subject to a secondary series of registers. We will discuss the former in sections 2.2 and 2.3.

3.1.2 Input Clock Frequencies

It is recommended that a 16 MHz clock is used to generate CIF-25fps, CIF-30fps and QCIF-60fps and that an 8 MHz clock is used to generate QCIF-25fps and QCIF-30fps, however the sensor can adapt to a range of other input frequencies and still generate the required frame rates. For example, a 24 MHz clock can be used to generate CIF-30fps. By setting bit [7] of serial register [22] the sensor can automatically divide the incoming clock by 1.5 by setting bit [7] of serial register [22], such that the internal clock generator logic will still receive a 16 MHz clock.

Note that the clock division register is internally an 8 bit value, although the user may only program the lower nibble. The upper nibble is reserved for setting the clock divisor as we change between primary video modes. The lower nibble can be programmed to reduce the effective frame rate within each video mode.

The system clock divisor column in Table 5 assumes that the programmable pixel clock divisor is set to the default of 0, implementing a divide by 1 of the internal pixel clock. Consider the following scenario where a user requires 15 fps CIF resolution image. As can be seen there are a wide range of options to achieve the same result.

clk in (MHz)	Divide by 3/2 enabled?	System clock divisor	Pixel clock divisor	pclk (MHz)	Field Rate
8	no	4	1	2	15
12	yes	4	1	2	15
16	no	4	2	2	15
24	yes	4	2	2	15

Table 5 : System clock divisor options

3.2 Pixel Array

The physical pixel array is 364 x 296 pixels. The pixel size is 7.5 µm by 6.9 µm. The image size for NTSC is 306 x 244 pixels, for PAL and CIF it is 356 x 292 pixels, while for the QCIF modes the image size is 180 x 148 pixels. The remaining 4 physical columns on each side of the PAL image size prevent columns 1 and 2 in PAL/CIF modes from being distorted by the edge effects which occur when a pixel is close to the outer edge of the physical pixel array. Please note that these columns can be enabled as part of the visible image if the user is operating the sensor in the pantilt QCIF mode.

Figure 3 shows how the 306 x 244 and 180 x 148 sub-arrays are aligned within the bigger 364 x 296 pixel array. The Bayer colourisation pattern requires that the top-left corner of the pixel sub-array is always a Green 1 pixel. To preserve this Bayer colour pattern the NTSC sub-array has been offset relative to the centre of the array. The QCIF size images are centrally orientated.

Image read-out is very flexible. Sections 3.3.2 - describe the options available to the user. By default the sensor read out is configured to be horizontally 'shuffled' non-interlaced raster scan. The horizontally 'shuffled' raster scan order differs from a conventional raster in that the pixels of individual rows are re-ordered, with the odd pixels within a row read-out first, followed by the even pixels. This 'shuffled' read-out within a line, groups pixels of the same colour (according to the Bayer pattern - Figure 2) together, reducing cross talk between the colour channels. This option is on by default and is controllable via the serial interface. The horizontal shuffle option would normally only be selected with the colour sensor variant, VV6410.

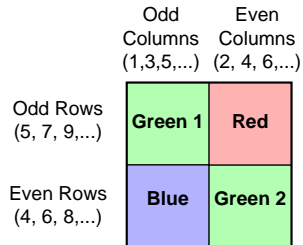

Figure 2 : Bayer Colourisation Pattern (VV6410 only)

3.3 X-offset and Y-offset

The image information is retrieved from the pixel array via a 2 dimensional address. The x and y address busses count from a starting point described by x-offset, y-offset up to a maximum count in x and y that is determined by the image size. The order of this count and the count step size is dependent upon the special image format parameters described below. The detailed control of the x and y address counters is entirely handled by the sensor logic

As can be seen in Figure 3 the visible array size is 364 columns by 296 rows. The PAL and CIF images are sized, 356 columns by 292 rows, thus we have a "border" of visible pixels that we do not read out if either of these modes are selected.

The images that are read out of the sensor are always "centred" on the array, therefore we allow a border of 4 columns at either end of the image in the x-direction and a border of 2 rows at the top and bottom of the image in the y-direction. The pantilt QCIF and NTSC video modes are similarly centred within the full size array.

For all the modes except the pantilt QCIF the x and y offset coordinates are fixed. If the user selects the pantilt QCIF mode then they may specify x and y-offsets in the range:

- (xoffset \geq 1) and (xoffset \leq 185)
- (yoffset \geq 5) and (yoffset \leq 149)

The sensor will automatically clip values outwith the specified ranges. The y addresses less than 5 are reserved for the sensor black lines and the y address greater than 296 are reserved for the sensor dark lines. Neither the black lines nor the dark lines contain visible image data

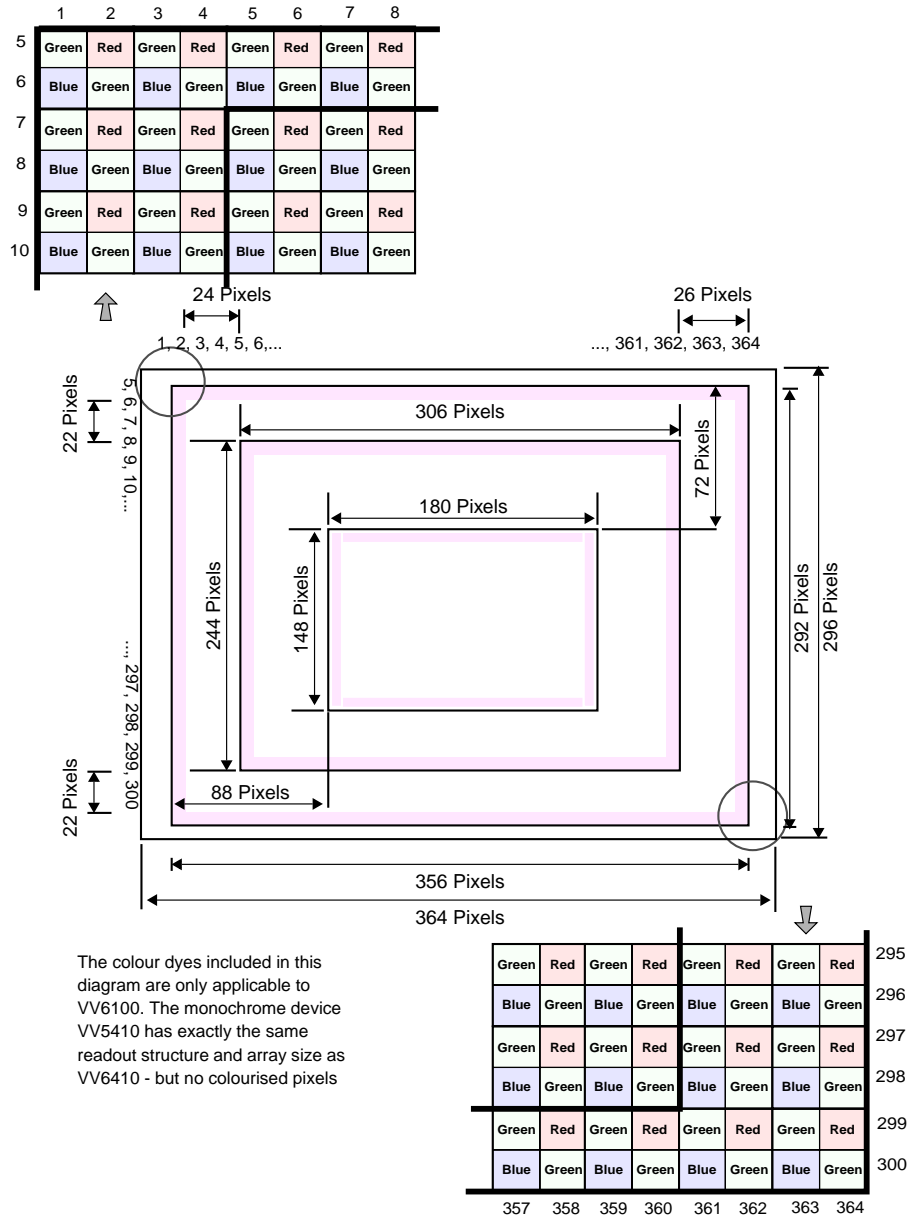

The colour dyes included in this diagram are only applicable to VV6100. The monochrome device VV5410 has exactly the same readout structure and array size as VV6410 - but no colourised pixels

Figure 3 : Image Readout Formats

3.3.1 Image readout parameters

The following parameters are available to process the sensor readout:

- Shuffle horizontal readout, enabled by setting bit [7] of serial register [17]
- Mirror horizontal readout, enabled by setting bit [3] of serial register [22]
- Shuffle vertical readout, enabled by setting [2] of serial register [22]
- Flip vertical readout, enabled by setting [4] of serial register [22]

The effect of each of these parameters is probably best described via a series of diagrams, see sections 3.3.2 - below.

Although all the above features may be used in conjunction with one another we will only display one special image readout parameter at any one time.

3.3.2 Horizontal shuffle

Figure 5 is the reference figure that shows the image readout without any of the optional image parameters, shuffle or mirror, selected. Figure 5 shows how the image will appear if the horizontal shuffle bit has been selected. Note that the even columns, (column 2,4,6 etc), are read out first followed by the odd columns, (1,3,5,7 etc).'

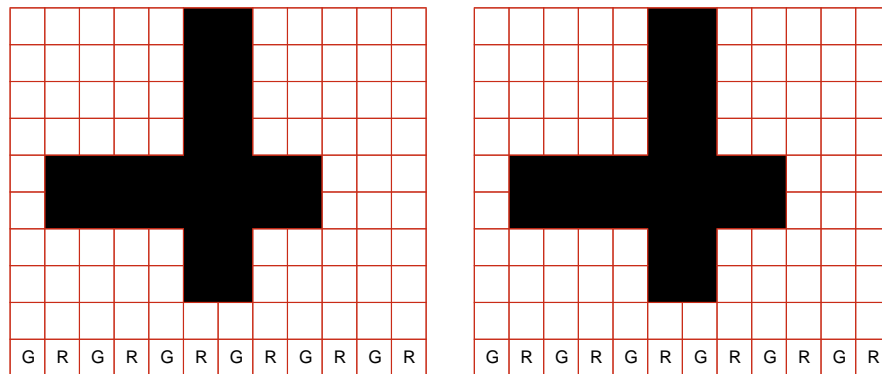

Where G - Green and R - Red

Figure 4 : Standard Image Readout

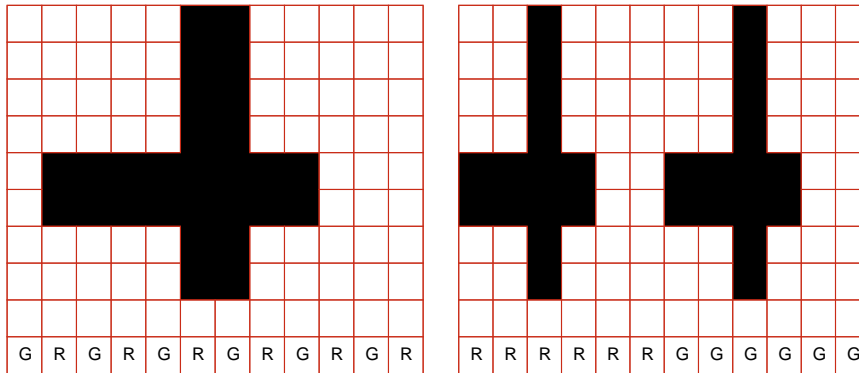

Where G - Green and R - Red

Figure 5 : Horizontal Shuffle Enabled

3.3.3 Horizontal mirror

Figure 6 shows the output image with the horizontal mirror feature enabled. Note that the columns are read out in reverse order.

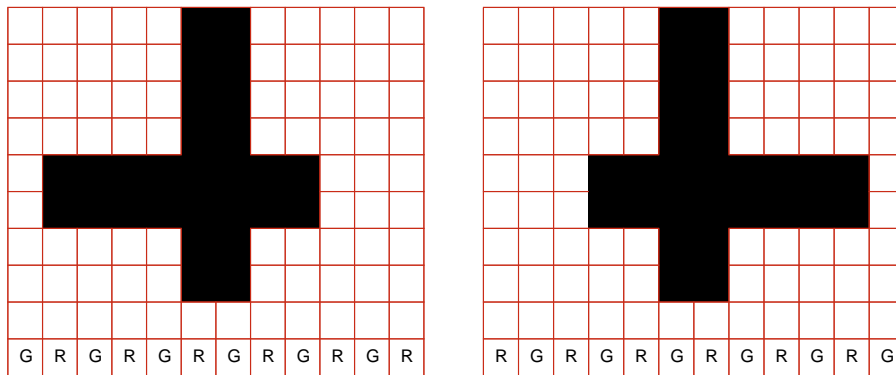

Where G - Green and R - Red

Figure 6 : Horizontal mirror enabled

3.3.4 Vertical Flip

Figure 7 shows the output image with the vertical flip feature enabled. Note that the even rows (rows 2,4,6 etc), are read out first

followed by the odd rows, (rows 1,3,5 etc)

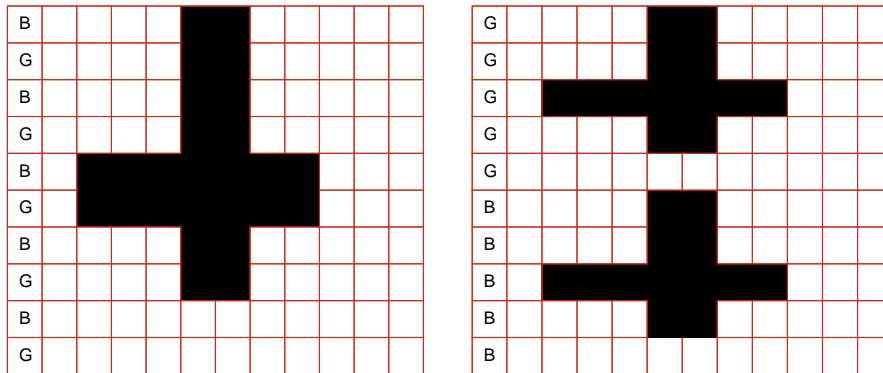

Where G - Green and B - Blue

Figure 7 : Vertical Shuffle enabled

3.3.5 Vertical Flip

Figure 3.4 shows the output image with the vertical flip feature enabled. Note that the rows are read out in reverse order.

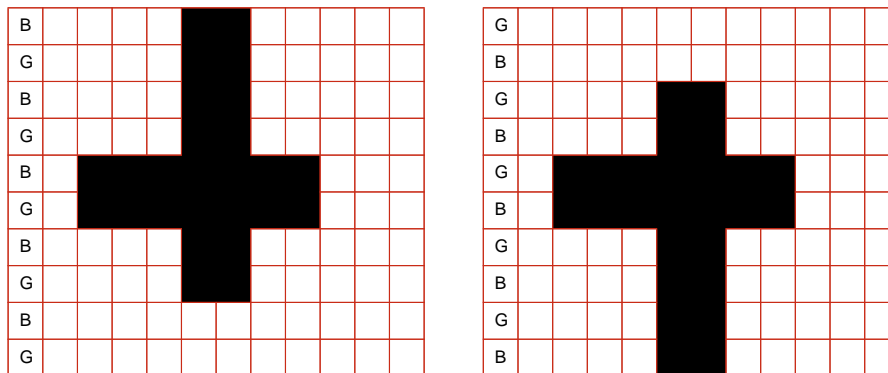

Where G - Green and B - Blue

Figure 8 : Vertical Flip enabled

3.4 QCIF Output Modes

VV5410/VV6410 has two QCIF output modes, pan/tilt QCIF (ptQCIF) and sub sampled QCIF (ssQCIF), both of which have the same output format. The data contained within the active QCIF image differs between the sub sampled and pan tilt modes. As the QCIF mode contains a quarter of the data of the CIF mode, the effective pixel clock can be run at a quarter of the rate. This means that in CIF mode a system clock of 16MHz will produce a field rate of 30fps, whereas in QCIF mode a system clock of only 8MHz is required to produce the same field rate. Note that the sensor divides the system clock internally by 4 for CIF mode and 8 for QCIF mode. If the user supplied the sensor with a 16Mhz system clock and selected QCIF mode then a field rate of 60fps is possible.

3.4.1 Pan/Tilt QCIF

In this mode the QCIF image is generated by outputting a cropped portion of the CIF image as illustrated in Figure 9. When the pan-tilt QCIF video mode is initially selected the image will be horizontally and vertically justified in the within the full size array (364 pixels by 292 pixels). The coordinates which define the top left corner of the QCIF portion of the array to be output are defined by the x-offset & y-offset parameters in serial registers [88 - 91] inclusive.

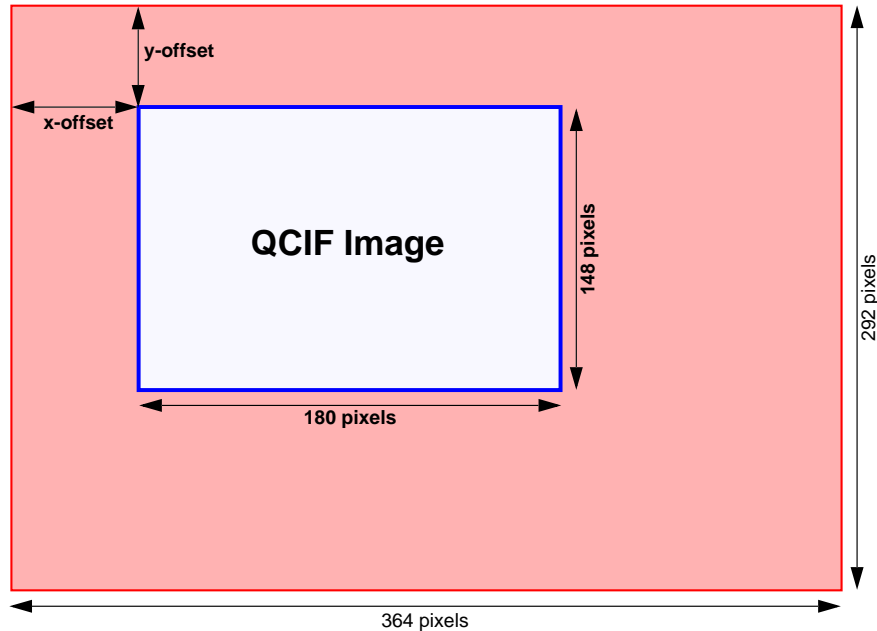

Figure 9 : Pan/Tilt QCIF Image Format

The x-offset and y-offset parameters are subject to minimum and maximum values which are set according to the video output mode (horizontal shuffle etc). Any clipping (against a maximum) or clamping (against a minimum) will be automatically controlled by the sensor logic. Regardless of whether any of the shuffle/mirror modes have been selected the user should always identify the top left corner coordinates as the x-offset and y-offset. To preserve the Bayer pattern at the sensor output the first pixel image of the image should always be green followed by red. If the x or y offsets are adjusted by a single step, i.e. adjust the x-offset from n to n+1, then this pattern will be corrupted. The user should always write an **odd** number to the x and y offset registers and this will preserve the Bayer pattern. The 5410, monochrome sensor is unaffected by such an adjustment to the x-offset coordinate, as the pixels do not contain any colour information.

3.4.2 Sub-Sampled QCIF

In this mode the QCIF image is generated by sub-sampling the CIF image in groups of 4 to preserve the Bayer pattern with every second group of pixels & lines skipped as illustrated in Figure 10. Although the former would not necessarily apply to a monochrome sensor the same address sequence is preserved. VV5410 users should ignore the colour references in Figure 10. Due to the crude nature of the sub-sampling, the resultant output image will be of inferior quality but contains full field of view and is intended for use in gesture recognition applications or perhaps as a preview option before switching to pan tilt QCIF mode to view the required scene region in more detail.

Green	Red	Green	Red	Green	Red	Green	Red	Green	Red	Green	Red
Blue	Green	Blue	Green	Blue	Green	Blue	Green	Blue	Green	Blue	Green
Green	Red	Green	Red	Green	Red	Green	Red	Green	Red	Green	Red
Blue	Green	Blue	Green	Blue	Green	Blue	Green	Blue	Green	Blue	Green
Green	Red	Green	Red	Green	Red	Green	Red	Green	Red	Green	Red
Blue	Green	Blue	Green	Blue	Green	Blue	Green	Blue	Green	Blue	Green
Green	Red	Green	Red	Green	Red	Green	Red	Green	Red	Green	Red
Blue	Green	Blue	Green	Blue	Green	Blue	Green	Blue	Green	Blue	Green

Bayer Colourised Pixel Array

Green	Red			Green	Red			Green	Red		
Blue	Green			Blue	Green			Blue	Green		
Green	Red			Green	Red			Green	Red		
Blue	Green			Blue	Green			Blue	Green		

Sub-Sampled Bayer Colourised Pixel Array

Figure 10 : Sub-Sampled QCIF Image Format

4. Black Offset Cancellation

In order to produce a high quality output image from VV6410 it is important to maximise the dynamic range of the video output. This can be achieved by accurately controlling the video signal black level. Within the sensor array of VV6410 there are a number of lines that are specified to be black, that is they are exposed to the incident light but they are always held in minimum exposure. VV6410 also has a number of dark lines, that is lines that are integrated for the same length of time as the visible lines but the pixels within these dark lines are shielded from incident light by an opaque material (e.g. metal 3). The diagram below shows where the different types of lines that appear within the full array.

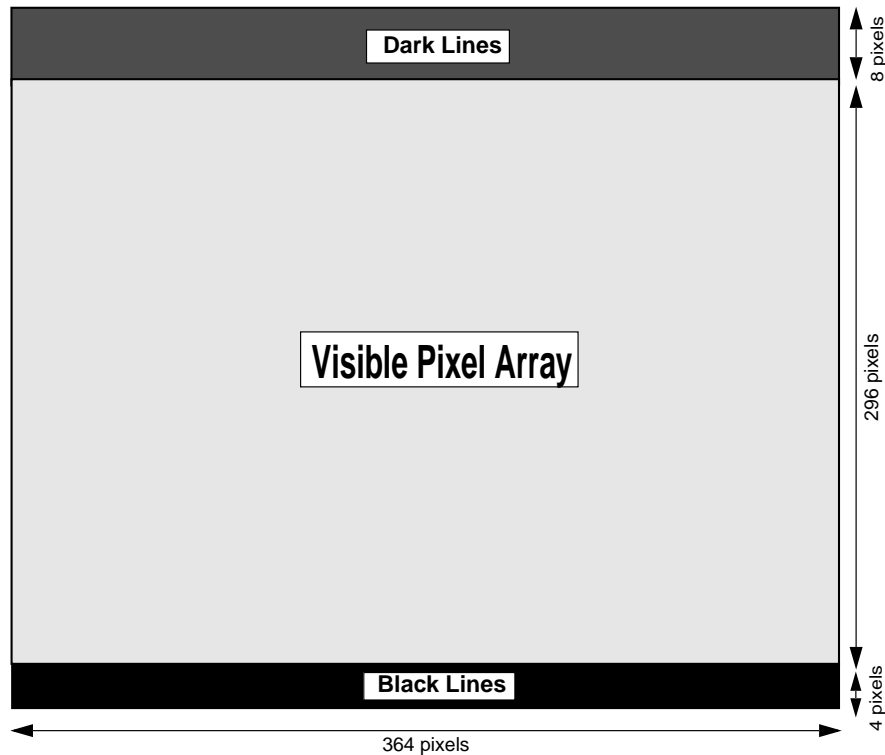

Figure 11 : Physical position of Black and Dark Lines

VV5410/VV6410 can perform automatic black offset cancellation. VV5410/VV6410 contains an algorithm that monitors the level of the designated black pixels and applies a correction factor, if required, to provide an ideal black level for the video stream.

The user can control the application of the offset cancellation parameter. The internally calculated offset can be applied to the video stream or alternatively an externally calculated offset can be applied or finally there is the option of applying no offset at all. Details of how to select the aforementioned modes can be found in subsubsection 9.5.5.

The black offset cancellation algorithm accumulates data from the centre 2 of the 4 physical black lines. The internal cancellation algorithm uses a leaky integrator model to control the size of the calculated offset. The leaky integrator model takes as input the current offset plus a shifted version of the error between the ideal black level and the current offset. The magnitude of the shift in the error is programmable. It is also possible to control the range of pixel values that will inhibit a change in the calculated offset. A narrow band (128 +/- 2 codes) or a wide band (128 +/- 4 codes) can be selected. If the latter is selected and the pixel average

returned in the current field lies between 124 and 132 then the offset cancellation will remain unchanged.

Following a gain change, or when exiting low-power, sleep or suspend modes, the internal (19bit) offset register will be reset to the default resulting in an automatic black offset of -64.

5. Dark Offset Cancellation

VV5410/VV6410 performs dark line offset cancellation as well as black line offset cancellation. A dark line is shielded from incident light by an opaque material such as metal 3 (as an example) but these lines will be exposed to incident light for the same length of time as the visible pixels. If the dark pixels are completely shielded from light then no incident light should reach the pixels and the pixels will produce the same digital code as the black pixels, i.e. 128 internally (therefore 64 externally). The algorithm used to calculate the dark offset cancellation is identical to that used to calculate the black offset cancellation, however the dark algorithm does assume that the dark pixels have already been black corrected therefore the target dark average is 64 thus the dark offset cancellation is 0 by default.

The dark offset cancellation algorithm is configured by the dark offset cancellation setup register, [46], see subsection 9.5.3. The only parameter in this that is different from the corresponding table that configures the black offset cancellation algorithm is the control bit, [bit2], that determines the number of dark lines that are to be used by the cancellation algorithm. It is possible to select half of the total number of available dark lines to be used to calculate the dark offset cancellation setting. When the former is selected the dark lines used by the algorithm are always preceded by another dark line, thereby giving extra immunity from damaging edge effects that may occur on lines close to the edge of the shield material.

It should be noted that the black and dark offset cancellation are completely independent. For example it is possible for the user to select internal automatic black offset cancellation but to opt for no dark offset cancellation or indeed choose to perform the dark offset cancellation externally.

6. Exposure Control

6.1 Calculating Exposure Period

The exposure time, comprising coarse and fine components, for a pixel and the analogue gain are programmable via the serial interface.

The coarse exposure value sets the number of complete lines a pixel exposes for, while the fine exposure sets the number of additional pixel clock cycles a pixel integrates for. The sum of the two gives the overall exposure time for the pixel array.

Exposure Time = ((Coarse setting x Line Period) + (Fine setting)) x (CLKI clock period) x Clock Divider Ratio_{note1}

note1: Clock Divider Ratio = 1/(Basic Clock Division * Optional Pixel Clock Divisor)

Default Clock Divider Ratio as follows: (Optional Pixel Clock Divisor = 1)

- PAL/NTSC - 1/2
- CIF - 1/4
- QCIF - 1/8

The maximum coarse and fine exposure settings are a function of the field and line lengths respectively. The maximum coarse exposure is current field length - 1 and the maximum fine exposure is current line length - fixed offset, see below. If an exposure value is requested that is beyond the maximum then the applied exposure setting will be clipped to the current maximum.

Video Mode	Fine Exposure Offset (pck's)
NTSC	51
PAL	86
CIF	51
QCIF	23

Table 6 : Fine Exposure Offset

The current revision of VV5410/VV6410 in the following modes of operation:

VP3 mode (OFF), QCIF and PAL (Video mode)

has an error in the application of coarse exposure. Please contact STMicroelectronics for more details.

6.2 Gain Components

The analogue gain in VV5410/VV6410 is programmed via the 8 bit gain register[36]. The analogue gain comprises 2 components, capacitive gain, (set by the ms nibble), and current gain, (set by the ls nibble). It is strongly recommended that the capacitive gain setting is left at the default value of 4'b1111. Table 7 details the available gain settings in 9bit, (PAL or NTSC), and 10bit, (CIF or QCIF), modes. We assume that mode_select[24], bit1 is 0. gain[7:0] is the value programmed in register[36]. The ls nibble of the gain value is limited to 4'he, with 4'hf not permitted.

10bit ADC mode				9bit ADC mode			
gain[7:0]	igain[3:0]	cgain[5:0]	Overall Gain	gain[7:0]	igain[3:0]	cgain[5:0]	Overall Gain
8'hfe	1 (0001 ₂)	63	8.000	8'hfe	1 (0001 ₂)	31	8.000
8'hfd	2 (0010 ₂)	63	5.333	8'hfd	2 (0010 ₂)	31	5.333
8'fc	3 (0011 ₂)	63	4.000	8'fc	3 (0011 ₂)	31	4.000
8'hfb	4 (0100 ₂)	63	3.200	8'hfb	4 (0100 ₂)	31	3.200
8'hfa	5 (0101 ₂)	63	2.667	8'hfa	5 (0101 ₂)	31	2.667
8'hf9	6 (0110 ₂)	63	2.2857	8'hf9	6 (0110 ₂)	31	2.2857
8'hf8	7 (0111 ₂)	63	2.0000	8'hf8	7 (0111 ₂)	31	2.0000
8'hf7	8 (1000 ₂)	63	1.7778	8'hf7	8 (1000 ₂)	31	1.7778
8'hf6	9 (1001 ₂)	63	1.6000	8'hf6	9 (1001 ₂)	31	1.6000
8'hf5	10 (1010 ₂)	63	1.4545	8'hf5	10 (1010 ₂)	31	1.4545
8'hf4	11 (1011 ₂)	63	1.3333	8'hf4	11 (1011 ₂)	31	1.3333
8'hf3	12 (1100 ₂)	63	1.2308	8'hf3	12 (1100 ₂)	31	1.2308
8'hf2	13 (1101 ₂)	63	1.1429	8'hf2	13 (1101 ₂)	31	1.1429
8'hf1	14 (1110 ₂)	63	1.0667	8'hf1	14 (1110 ₂)	31	1.0667
8'hf0	15 (1111 ₂)	63	1.0000	8'hf0	15 (1111 ₂)	31	1.0000

Table 7 : Analogue Gain Settings

note: The relationship between the programmed gain value as written to register[36] and the igain (current gain) and cgain (capacitive gain) is as follows:

igain

If mode_select[24], bit 1 is set then igain[3:0] is the inverse of gain[3:0], i.e. if gain[3:0] = 6, igain[3:0] = 9.

If mode_select[24], bit 1 is reset then igain[3:0] is the inverse of the mirror of gain[3:0], i.e. bit 3 of igain is the inverse of bit 0 of gain, i.e. gain = 4 and igain = 13.

cgain

cgain is a 6 bit value therefore we have to pad the 4 bits of the gain register. In 10bit modes cgain[1:0] is fixed at 2'b11 and cgain[5:2] is set to gain[7:4]. In the 9bit modes cgain[1:0] is also set to 2'b11, however cgain[5:2] is set to gain[7:4] divided by 2, thus gain[7:4] = 4'b1111 gives cgain[5:0] = 6'b011111.

6.2.1 Recommended Gain Settings

To ensure optimum sensor performance it is recommended that the igain setting, controlled by the ls nibble of serial register[36₁₀], be limited to 12.

6.3 Clock Division

Although the clock divisor register is an 8 bit register the user only has write access to the lower 4 bits as described above. The upper 4 bits of the register are altered automatically when the video mode is changed by writing to Setup0[16] register. The upper 4 bits are pre-programmed as follows:

Video mode	Register[37], bits[7:4]	Effective system clock divisor
CIF	4'b0001	Divide CLKI/CLKIP by 4
QCIF	4'b0011	Divide CLKI/CLKIP by 8
PAL/NTSC	4'b0000	Divide CLKI/CLKIP by 2

Table 8 : System Clock Divisor Options

6.4 Updating Exposure, Gain and Clock Division Settings

Although the user can write a new exposure, gain or clock division parameter at any point within the field the sensor will only consume these new external values at a certain point. The exceptions to this behaviour are when the user has selected immediate update of gain and clock division. If the user has selected the former then the new gain or clock division value will be applied as soon as the serial interface message has completed. The fine and coarse exposure values are always written in a "timed" manner. There are a number of "update pending" flags available to the user (see Status0 reg[2] for details) that allows the user to detect when the sensor has consumed one of the timed parameters. In the next section of this document we will detail all the timed parameters and describe when they are updated.

It is important to realise that there is a 1 frame latency between a new exposure value being applied to the sensor array and the results of this new exposure value being read-out. The same latency does not exist for the gain value. To ensure that the effect of the new exposure and gain values are coincident the sensor delays the application of the new gain value by approximately one frame relative to the application of the new exposure value.

If the user is using the autoincrement option in the serial interface when writing a new series of exposure/gain and clock division parameters then it is important to ensure that the sensor receives the complete message bunch before updating any of the parameters. It is also important that the timed parameters are updated in the correct order, we will discuss this fully in the next section. If an autoincrement message sequence is in progress but we have reached the point in the field timing where the gain value would normally be updated, we actually inhibit the update. We inhibit the update to ensure that the gain change is not passed to the sensor while a change in the exposure is still pending.

7. Timed Serial Interface Parameters

The previous section, Exposure Control, introduced the concept of a "timed parameter", that is information that is written via the serial interface but will not be used immediately by the sensor, rather there will be a delay before the information is passed to the internal registers (referred to as the working registers) from the serial interface registers (referred to as the shadow registers). It is the contents of the working registers that will determine sensor behaviour.

The architecture of VV5410/6410 requires that many of the programmable registers are handled in such a manner. This section will identify all these registers, describe what they are all used for and then go on to explain when they are all updated.

7.1 Listing and Categorizing the Parameters

The timed parameters are split into 6 categories as follows:

- fine exposure
- coarse exposure
- clock division
- gain
- pan parameter
- tilt parameter
- video timing

There is a "pending" flag for each of the above categories. These flags are stored in Status0 Register[2]. If one of the flags is high this indicates that the working register/s controlled by that flag have yet to be updated from the according shadow register/s. This feedback information could be useful if a user is, for example, attempting to write an exposure controller. The status of the pending flags allows accurate timing of the serial interface communications.

7.1.1 Fine Exposure

The fine exposure category simply comprises registers[32,33].

7.1.2 Coarse Exposure

The coarse exposure category simply comprises registers[34,35].

7.1.3 Clock Division

The clock division category simply comprises register[37].

7.1.4 Gain

The gain category simply comprises register[36].

7.1.5 Pan Parameter

The pan parameter category comprises the following registers:

- Setup0[16] (The "pan_pend" flag will only be set if the subsampled QCIF mode is entered or exited)
- Setup1[17] (The "pan_pend" flag will only be set if the hshuffle control bit is changing state)
- Data_format[22] (The "pan_pend" flag will only be set if the hmirror control bit is changing state)
- X-offset[87,88] (The "pan_pend" flag set unconditionally)

7.1.6 Tilt Parameter

The tilt parameter category comprises the following registers:

- Setup0[16] (The "tilt_pend" flag will only be set if the subsampled QCIF mode is entered or exited)
- data_format[22] (The "tilt_pend" flag will be set if the hshuffle control bit or the hmirror control bit is changing state)
- Y-offset[89,90] (The "tilt_pend" flag set unconditionally)

7.1.7 Video Timing Parameter

The video timing parameter category comprises all the other shadow/working register pairs. The video timing parameter update pending flag will be unconditionally set if any of the following registers are written to:

- Setup0[16]
- Setup1[17]
- fg_mode[20]
- data_format[22]
- op_format[23]
- mode_select[24]
- Dark Pixel Offset[44,45]
- Dark Pixel Cancellation Setup Register
- Black Pixel Offset[44,45]
- Black Pixel Cancellation Setup Register
- Line Length[82,83]
- Field Length[97,98]

7.2 Timed Parameter Update Points

The timed parameter categories are updated as follows:

note: We refer to odd and even fields in the Table 9 below. In a video mode like CIF or QCIF the fields are all identical in length, we still have to be able to differentiate between fields to enable correct updating of register parameters.

Timed parameter category	Updated point
fine exposure	Conditional on a change pending in the line length register. Line length change pending: update fine exposure at the odd to even field transition Line length change not pending: update fine exposure during the start of active video (SAV) region of the end of frame (EOF) line (the line that follows the last line of active video) in the odd field.
coarse exposure	Updated during the SAV region of the first dark line in an odd field
clock division	Updated at the odd to even field transition
gain	Updated during the SAV region of the EOF line in the odd field
pan parameter	Updated during the SAV region of the EOF line in the odd field
tilt parameter	Updated during the SAV region of the first visible line in an odd field
video timing	Updated at the odd to even field transition

Table 9 : Timed Parameter Update Points

The order that the above timed parameters are updated is critical. Let us assume that all the pending flags are set, i.e. we have written to at least one register in each category. The working registers will be updated in the following order:

1. Coarse exposure
2. Tilt parameters



3. Gain, Pan parameters and conditionally the fine exposure (see Table 9 for details)
4. Clock division, video timing parameters and conditionally the fine exposure (see Table 9 for details)

8. Digital Video Interface Format

8.1 General description

The video interface consists of a bidirectional, tri-stateable 5-wire data bus. The nibble transmission is synchronised to the rising edge of the system clock (Figure 31).

Read-out Order	Progressive Scan (Non-interlaced)			
Form of encoding	Uniformly quantised, PCM, 8/10 bits per sample			
Correspondence between video signal levels and quantisation levels:	10-Bit Data		8-Bit Data	
	Pixel Values	1 to 1022	Pixel Values	1 to 254
	Black Level	64	Black Level	16

Table 10 : Video encoding parameters

Digital video data may be either 8 or 10 bits per sample, and can be transmitted in one of the following ways:

10-bit data

1. A series pair of 5-bit nibbles, most significant nibble first, on 5 wires.
2. An 8-bit number e.g. line code. line numbers and status line data is padded with 00 in the least significant two bits to make up a 10-bit value.

8-bit data

1. A single 8 bit byte over 8 output wires^{note}.
2. A series pair of 4-bit nibbles, most significant nibble first, on 4 wires.
3. The top 8-bits of a 10-bit value e.g. pixel data or line averages is used as the 8-bit equivalent.

note: if the 8-wire output mode has been selected then the normal FST/LST pin function is sacrificed as these pins are required to output data information

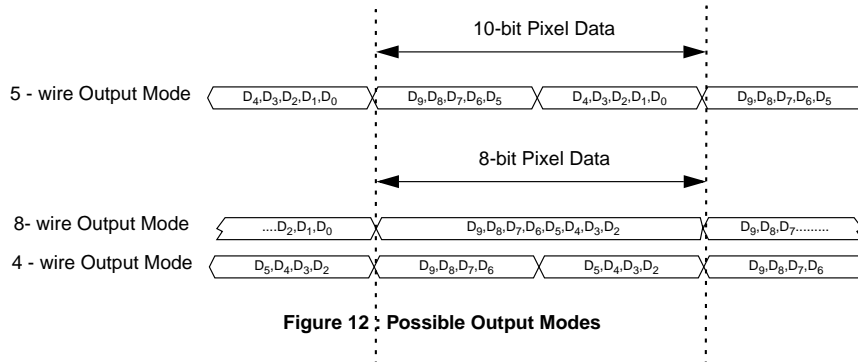

Figure 12 : Possible Output Modes

In the following description the 4-wire mode is used as an example. The 5-wire mode can be viewed as a variant of the 4-wire mode. Data is output on the least significant data wires available. e.g. in 4-wire mode, data is output on data wires D[3:0] while in

5-wire mode data is output on D[4:0].

Multiplexed with the sampled pixel data is control information including both video timing references, sensor status/configuration data and the pixel average from the current line.

Video timing reference information takes the form of field start characters, line start characters, end of line characters and a line counter.

Where hexadecimal values are used, they are indicated by a subscript H, such as FF_H; other values are decimal.

8.2 Embedded control data

To distinguish the control data from the sampled video data all control data is encapsulated in embedded control sequences. These are 6 bytes long and include a combined escape/sync character sequence, 1 control byte (the 'command byte') and 2 bytes of supplementary data.

To minimise the susceptibility of the embedded control data to random bit errors redundant coding techniques have been used to allow single bit errors in the embedded control words to be corrected. However, more serious corruption of control words or the corruption of escape/sync characters cannot be tolerated without loss of sync to the data stream. To ensure that a loss of sync is detected a simple set of rules has been devised. The four exceptions to the rules are outlined below:

1. Data containing a command word that has two bit errors.
2. Data containing two 'end of line' codes that are not separated by a 'start of line' code.
3. Data preceding an 'end of field' code before a 'start of frame' code has been received.
4. Data containing line that do not have sequential line numbers (excluding the 'end of field' line).

If the host detects one of these violations then it should abandon the current field of video

8.2.1 The combined escape and sync character

Each embedded control sequence begins with a combined escape and sync character that is made up of three words. The first two of these are FF_H FF_H constituting two words that are illegal in normal data. The next word is 00_H - guaranteeing a clear signal transition that allows a host to determine the position of the word boundaries in the serial stream of nibbles. Combined escape and sync characters are always followed by a command byte - making up the four byte minimum embedded control sequence.

8.2.2 The command word

The byte that follows the combined escape/sync characters defines the type of embedded control data. Three of the 8 bits are used to carry the control information, four are 'parity bits' that allow the host to detect and correct a certain level of errors in the transmission of the command words, the remaining bit is always set to 1 to ensure that the command word never has the value 00_H. The coding scheme used allows the correction of single bit errors (in the 8-bit sequence) and the detection of 2 bit errors. The three data bits of the command word are interpreted as shown in Figure 13. The even parity bits are based on the following relationships:

1. An even number of ones in the 4-bit sequence (C₂, C₁, C₀ and P₀).
2. An even number of ones in the 3-bit sequence (C₂, C₁, P₁).
3. An even number of ones in the 3-bit sequence (C₂, C₀, P₂).
4. An even number of ones in the 3-bit sequence (C₁, C₀, P₃).

Table 13 shows how the parity bits may be used to detect and correct 1-bit errors and detect 2-bit errors.

8.2.3 Supplementary Data

The last 2 bytes of the embedded control sequence contains supplementary data. There are two options:

1. The last 2 bytes of the SAV 6 byte sequence contain the current 12-bit line number. The 12-bit line number is packaged up by splitting it into two 6-bit values. Each 6-bit value is then converted into an 8-bit value by adding a zero to the start and an odd word parity bit at the end.
2. The 5th byte of the EAV sequence contains a pixel average for that line either based upon the middle 256 pixels if the CIF, PAL or NTSC video modes are selected or the middle 128 pixels if the QCIF video mode is selected. The final byte is FF_H.

Note: in 5-wire mode, the embedded control data is calculated as detailed above and output as the most significant 8-bits. The least significant 2-bits are padded with zero.

Line Code	Nibble X _H (1 C ₂ C ₁ C ₀)	Nibble Y _H (P ₃ P ₂ P ₁ P ₀)
End of Line	1000 ₂ (8 _H)	0000 ₂ (0 _H)
Blank Line (BL)	1001 ₂ (9 _H)	1101 ₂ (D _H)
Black line (BK)	1010 ₂ (A _H)	1011 ₂ (B _H)
Visible Line (VL)	1011 ₂ (B _H)	0110 ₂ (6 _H)
Start of Even Field (SOEF)	1100 ₂ (C _H)	0111 ₂ (7 _H)
End of Even Field (EOEF)	1101 ₂ (D _H)	1010 ₂ (A _H)
Start of Odd Field (SOOF) ^{note1}	1110 ₂ (E _H)	1100 ₂ (C _H)
End of Odd Field (EOOF) ^{note2}	1111 ₂ (F _H)	0001 ₂ (1 _H)

Table 11 : Embedded Line Codes

note1: This code is only generated in the PAL or NTSC video modes

note2: This code is only generated in the PAL or NTSC video modes

We include Table 12 to show how the 8 bit control codes are mapped onto the output data bits in the 5 wire mode.

Line Code	Most significant nibble Data[4:0]	Least significant nibble Data[4:0]
End of Line	1_0000 ₂ (10 _H)	0_0000 ₂ (00 _H)
Blank Line (BL)	1_0011 ₂ (13 _H)	1_0100 ₂ (14 _H)
Black line (BK)	1_0101 ₂ (15 _H)	0_1100 ₂ (0C _H)
Visible Line (VL)	1_0110 ₂ (16 _H)	1_1000 ₂ (18 _H)
Start of Even Field (SOEF)	1_1000 ₂ (18 _H)	1_1100 ₂ (1C _H)
End of Even Field (EOEF)	1_1011 ₂ (1B _H)	0_1000 ₂ (08 _H)
Start of Odd Field (SOOF)	1_1101 ₂ (1D _H)	1_0000 ₂ (10 _H)
End of Odd Field (EOOF)	1_1110 ₂ (1E _H)	0_0100 ₂ (04 _H)

Table 12 : Mapping 8bit control codes to 5 wire output mode

Parity Checks				Comment
P ₃	P ₂	P ₁	P ₀	
✓	✓	✓	✓	Code word un-corrupted
✓	✓	✓	✗	P ₀ corrupted, line code OK
✓	✓	✗	✓	P ₁ corrupted, line code OK
✓	✗	✓	✓	P ₂ corrupted, line code OK

Table 13 : Parity Checking

Parity Checks				Comment
P ₃	P ₂	P ₁	P ₀	
x	✓	✓	✓	P ₃ corrupted, line code OK
x	x	✓	x	C ₀ corrupted, invert sense of C ₀
x	✓	x	x	C ₁ corrupted, invert sense of C ₁
✓	x	x	x	C ₂ corrupted, invert sense of C ₂
All other codes				2-bit error in code word.

Table 13 : Parity Checking

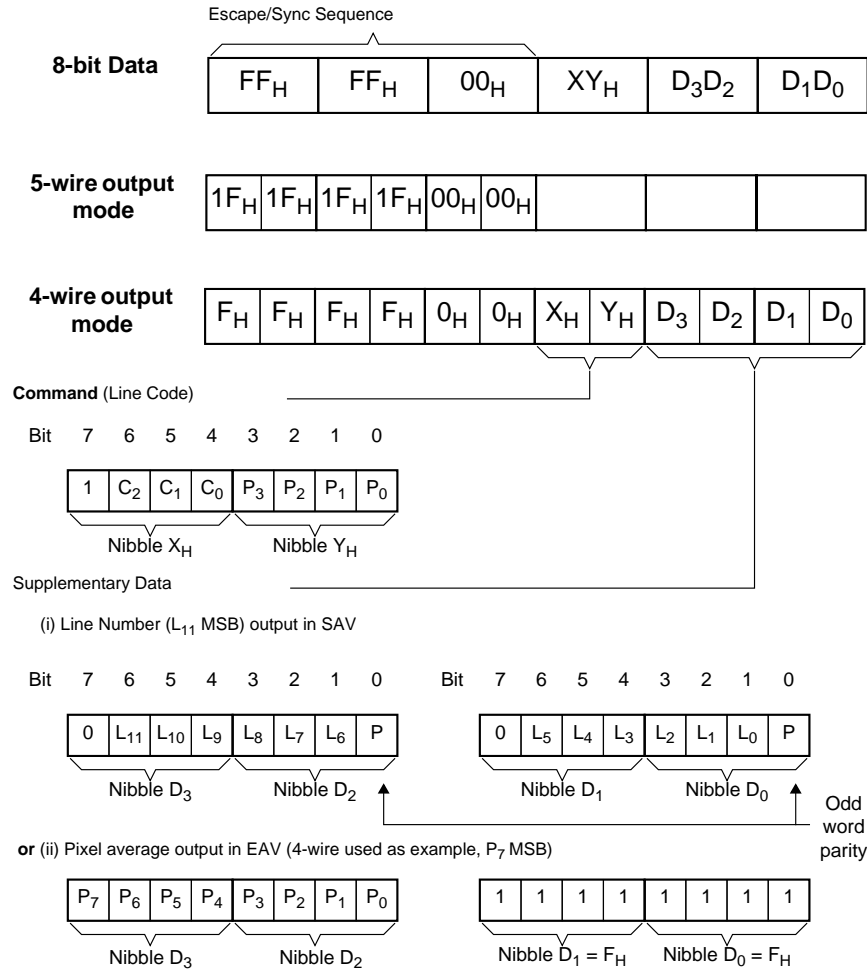

Figure 13 : Embedded Control Sequence

8.3 Video timing reference and status/configuration data

Each frame of video sequence comprises 2 fields. Each field of data is constructed of the following sequence of data lines.



1. A start of field line
2. A number of black lines
3. A number of blank (or dark) lines
4. A number active video lines
5. An end of field line
6. A number of blank or black lines

Video Format	NTSC			PAL			CIF			QCIF		
	VP3 mode			On		Off	On		Off	On		Off
Extra Black Lines	On	Off	N/A	On	Off	N/A	On	Off	N/A	On	Off	N/A
1st Field												
Start of Field Line	1	1	1	1	1	1	1	1	1	1	1	1
Black Lines	8	2	8	8	2	16	8	2	16	8	2	8
Blanking Lines	1	7	0	1	7	0	1	7	0	1	7	0
Dark Lines	0	0	8	0	0	2	0	0	10	0	0	2
Active Video lines	244	244	244	292	292	292	292	292	292	148	148	148
End of Field Line	1	1	1	1	1	1	1	1	1	1	1	1
Blanking Lines	0	7	0	0	9	0	0	17	0	0	1	0
Black Lines	7	0	0	9	0	0	17	0	0	1	0	0
Total	262	262	262	312	312	312	320	320	320	160	160	160
2nd Field												
Start of Field Line	1	1	1	1	1	1	1	1	1	1	1	1
Black Lines	8	2	8	8	2	16	8	2	16	8	2	8
Blanking Lines	1	7	0	1	7	0	1	7	0	1	7	0
Dark Lines	0	0	8	0	0	2	0	0	10	0	0	2
Active Video lines	244	244	244	292	292	292	292	292	292	148	148	148
End of Field Line	1	1	1	1	1	1	1	1	1	1	1	1
Blanking Lines	0	8	0	0	10	0	0	17	0	0	1	0
Black Lines	8	0	1	10	0	1	17	0	0	1	0	0
Total	263	263	263	313	313	313	320	320	320	160	160	160

Table 14 : Field and Frame Formats

Table 14 details the number of each type of data lines for NTSC, PAL, CIF and QCIF output formats. Each line of data starts with an embedded control sequence that identifies the line type (as outlined in Table 14). The control sequence is then followed by two bytes that contain a coded line number. The line number sequences starts with the start-of-frame line at 00_H and increments one per line up until the end-of-frame line. Each line is terminated with an end-of-line embedded control sequence. The line start embedded sequences must be used to recognise visible video lines as a number of null bytes may be inserted between successive data lines.

There are a series of figures (Figure 14 - Figure 25) on the following pages that show line type construction of the fields in each

of the available video modes in VV5410/VV6410.

8.3.1 Blank lines

In addition to padding between data lines, actual blank data lines may appear in the positions indicated above. These lines begin with start-of-blank-line embedded control sequences and are constructed identically to active video lines except that they will contain only blank bytes, 07_H, (expressed as 01C_H in 10bit form).

8.3.2 Black line timing

The black lines (which are used for black offset calculation) are identical in structure to valid video lines except that they begin with a start-of-black line code and contain either information from the sensor black lines or blanking data.

By default VP3 mode (see mode_select[24] for details) is selected. It is an option in any of the VP3 modes to select the additional black lines to be output (line 3-8). If the VP3 mode is not selected then all the black lines are enabled - no blank lines are output.

Internally there is the concept of dark lines - to be used for dark offset cancellation (see following diagrams to identify their position within the frame timing model), however externally the dark lines share the same line type code as the black lines.

8.3.3 Padding Lines and Fields

The user may choose to extend the inter-field period by increasing the field length by writing to serial registers 97 & 98. In this event, the appropriate number of additional black or blank lines is inserted between the End Of Field (EOF) line and the Start Of Field (SOF) line. This means that the distance between SOF and EOF will remain constant.

The user can also extend the line length by writing to serial registers 82 and 83. The line length padding is inserted after the EAV sequence, ensuring that the distance between the SAV and EAV sequences will remain constant.

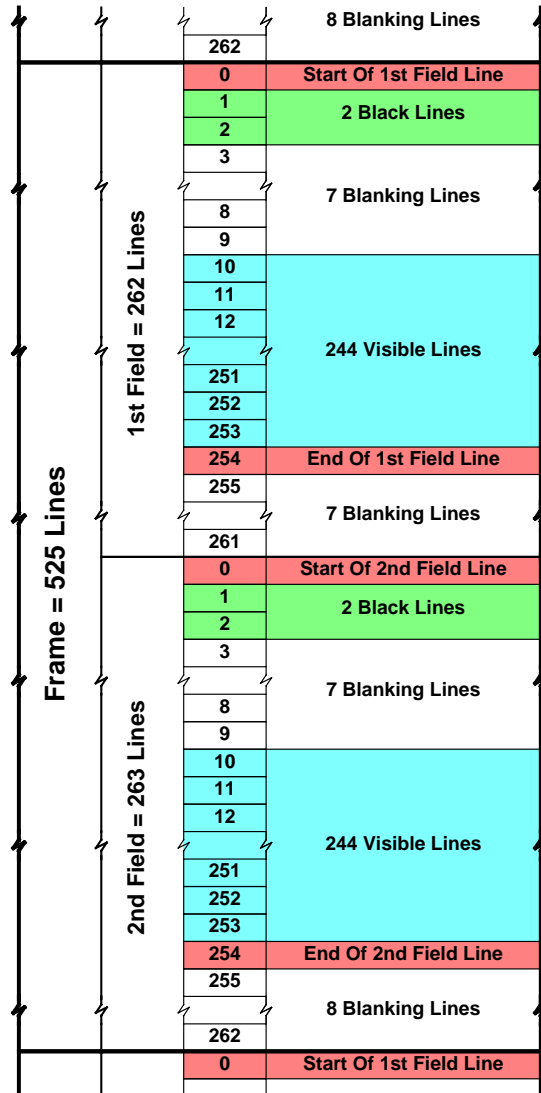

Figure 14 : NTSC Field and Frame Formats - VP3 Mode On, Extra Black Lines Off

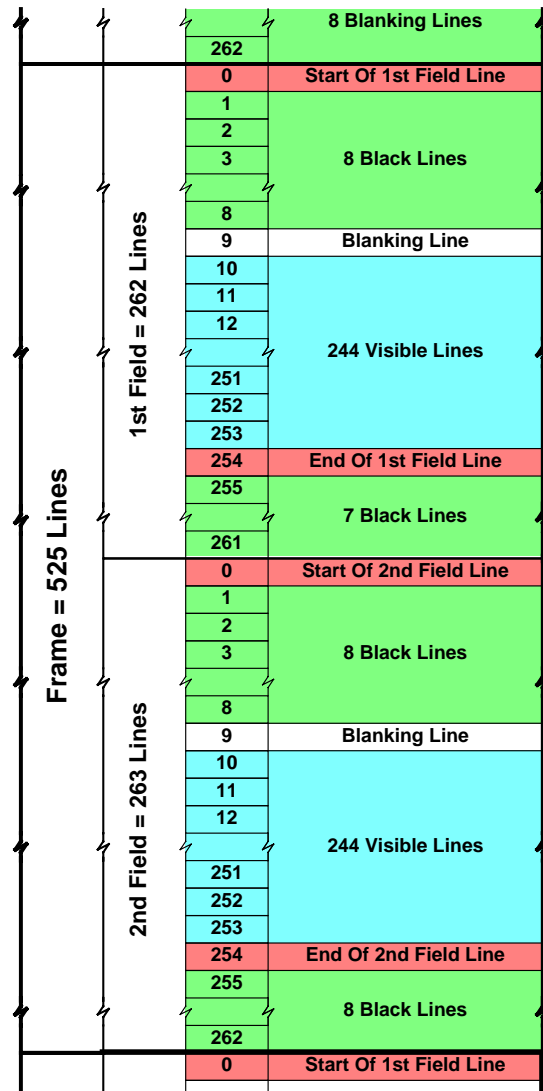

Figure 15 : NTSC Field and Frame Formats - VP3 Mode On, Extra Black Lines On

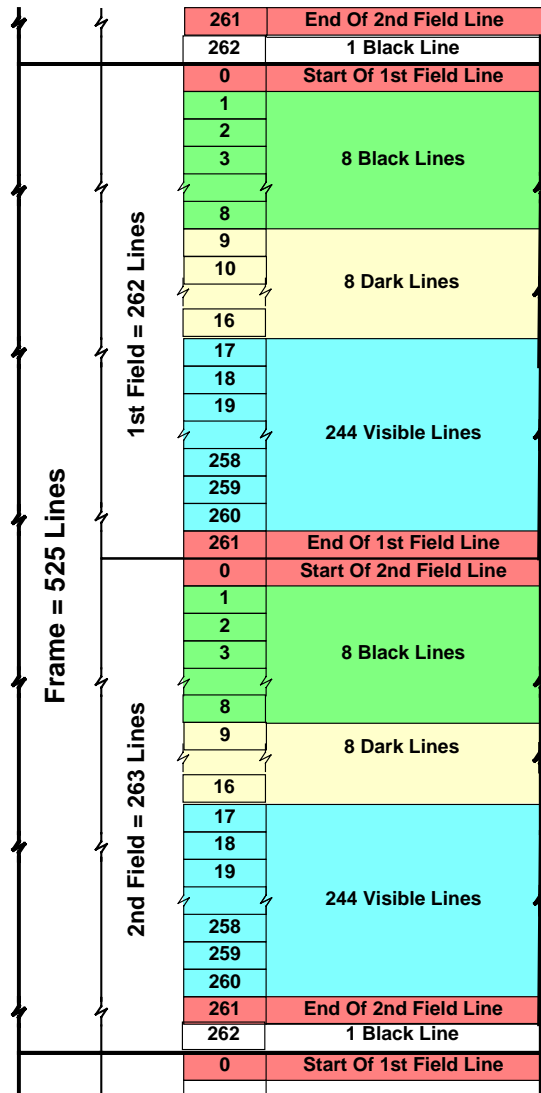

Figure 16 : NTSC Field and Frame Formats - VP3 Mode Off

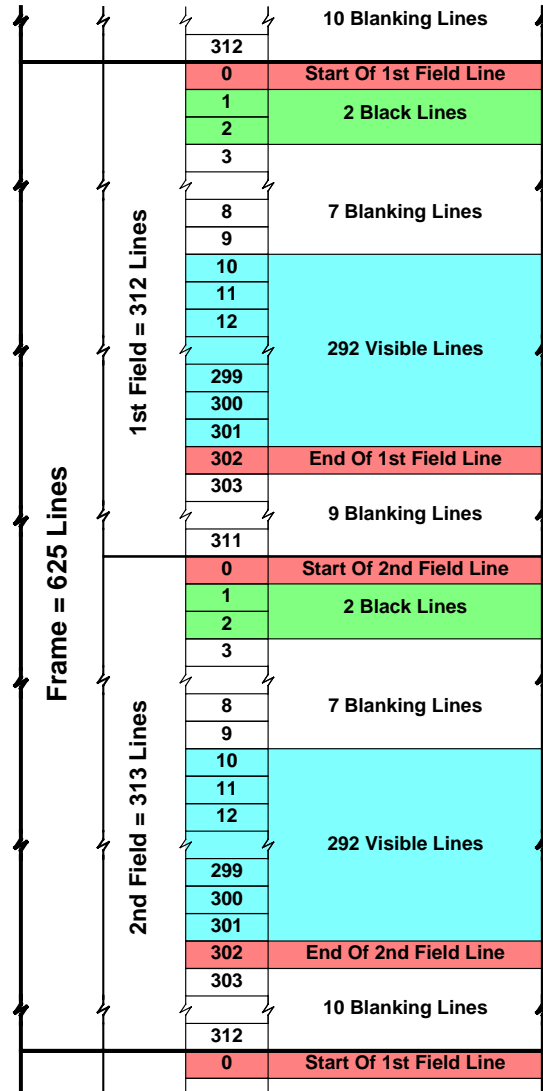

Figure 17 : PAL Field and Frame Formats - VP3 Mode On, Extra Black Lines Off

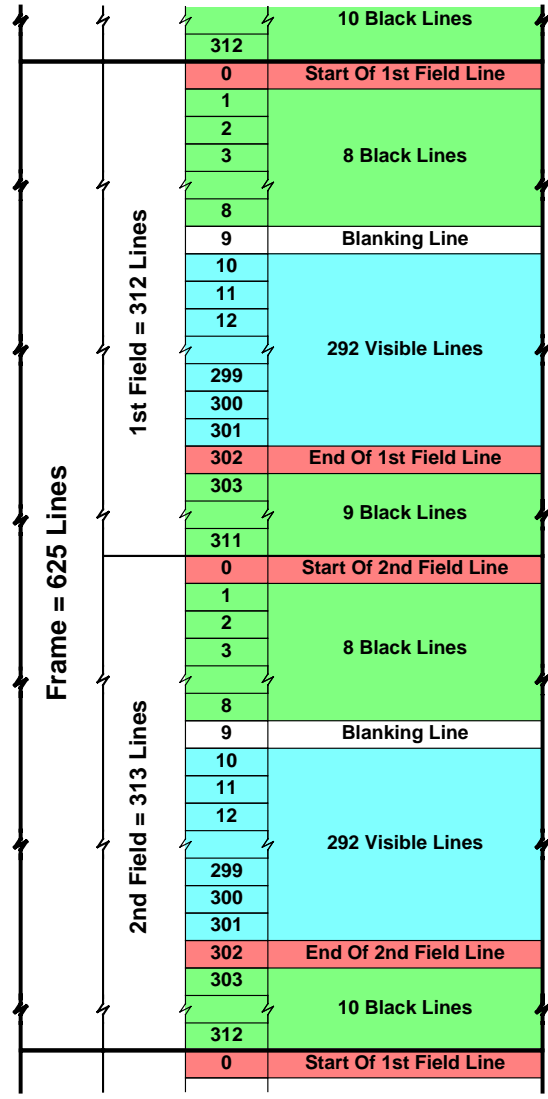

Figure 18 : PAL Field and Frame Formats - VP3 Mode On, Extra Black Lines On

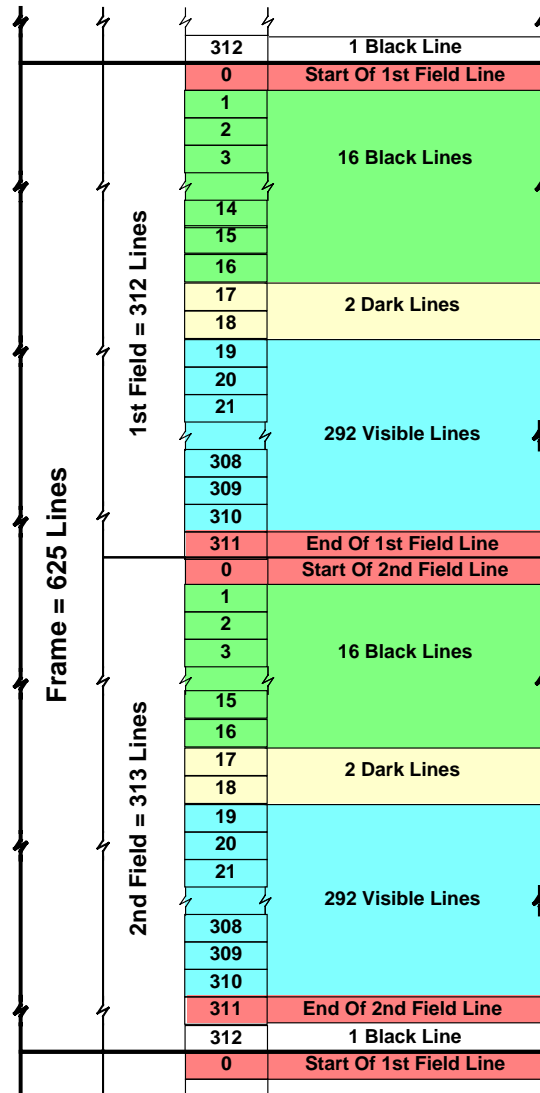

Figure 19 : PAL Field and Frame Formats - VP3 Mode Off

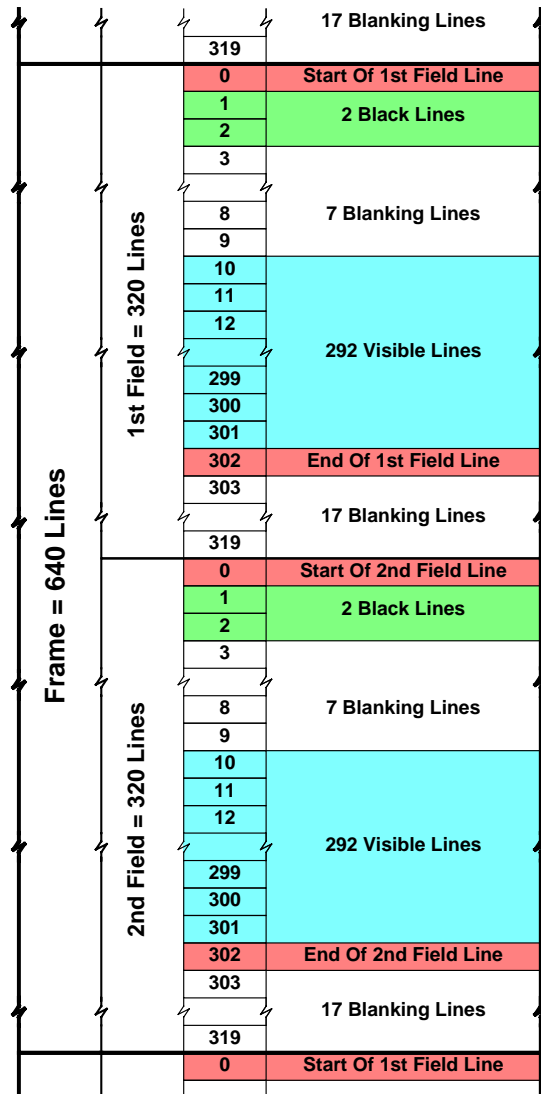

Figure 20 : CIF Field and Frame Formats - VP3 Mode On, Extra Black Lines Off

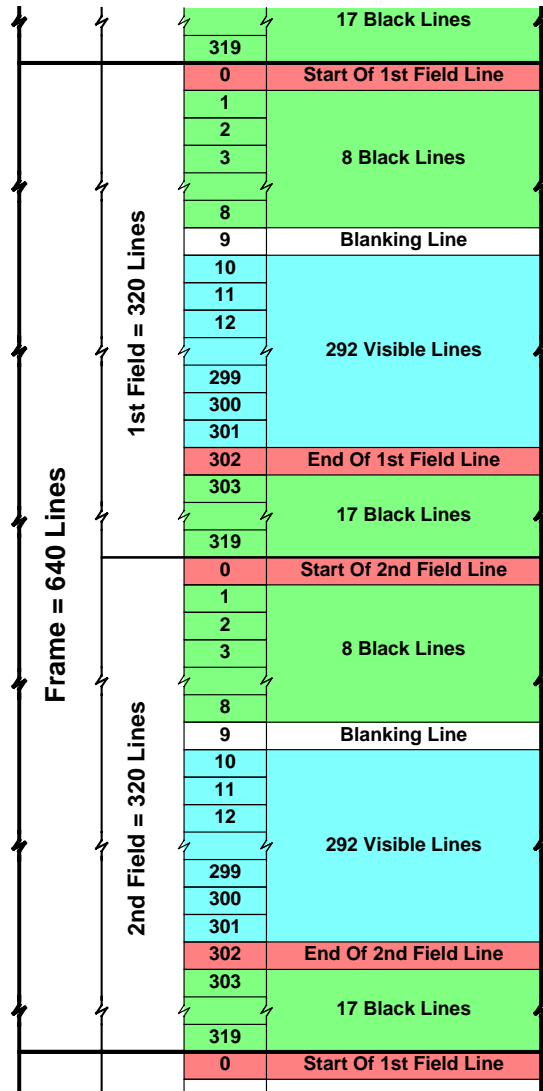

Figure 21 : CIF Field and Frame Formats - VP3 Mode On, Extra Black Lines On

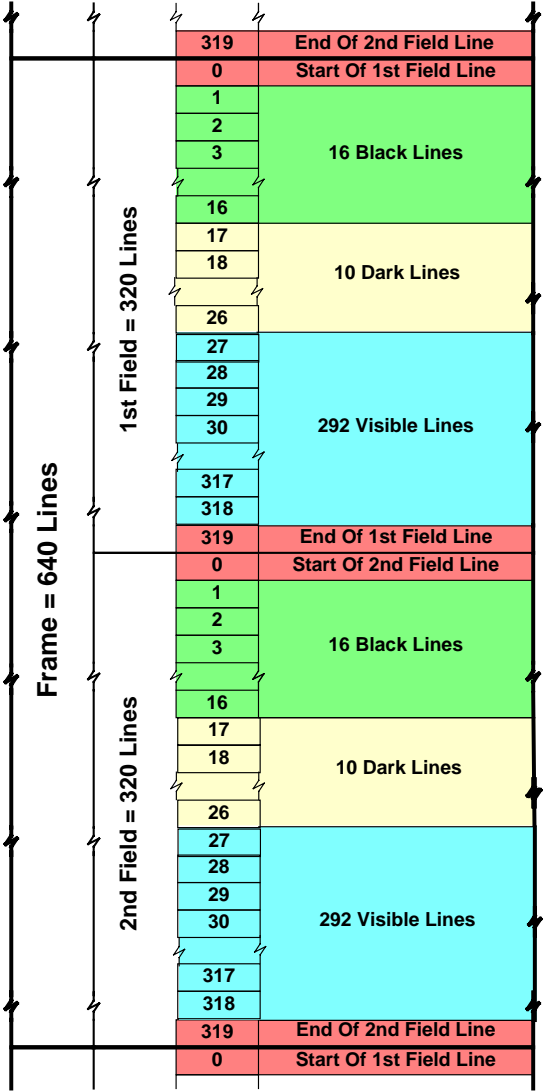

Figure 22 : CIF Field and Frame Formats - VP3 Mode Off

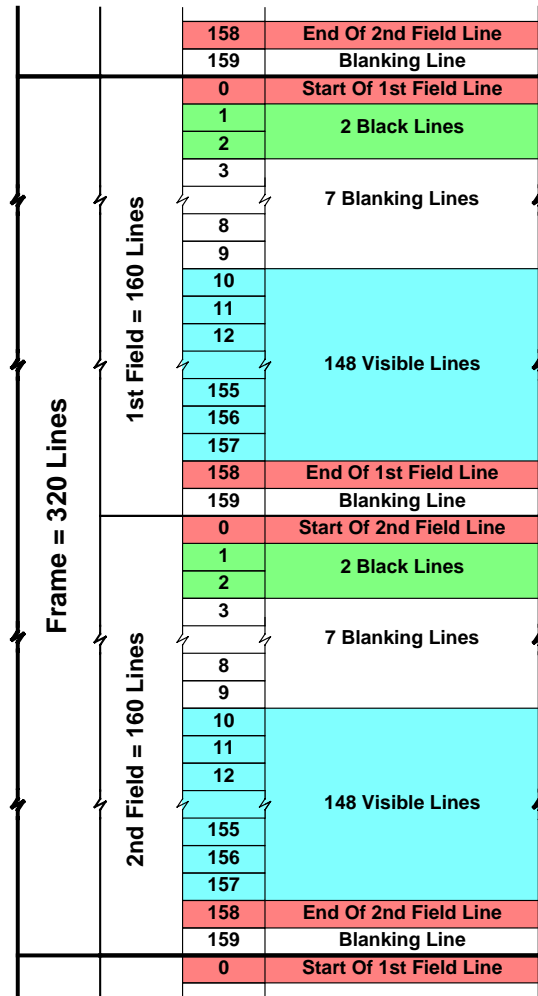

Figure 23 : QCIF Field and Frame Formats - VP3 Mode On, Extra Black Lines Off

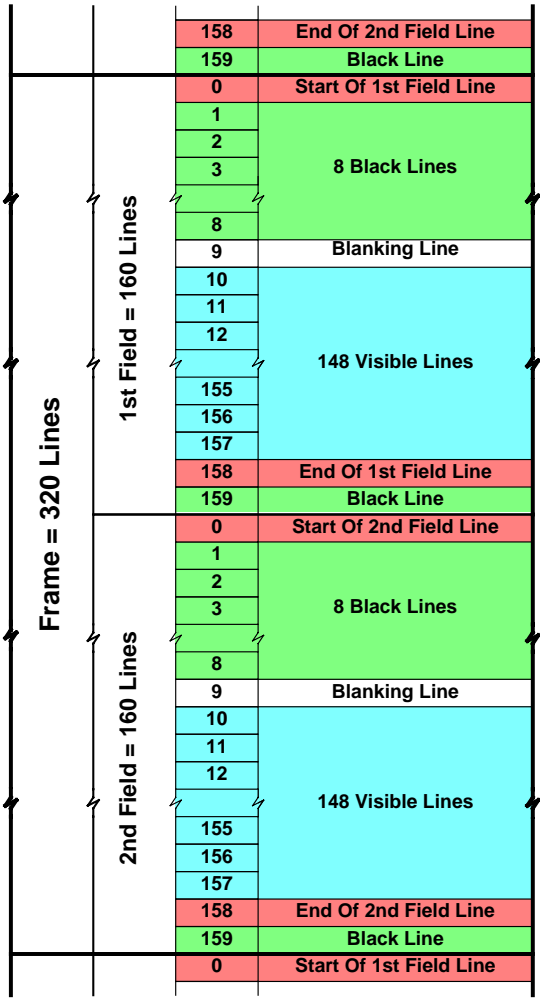

Figure 24 : QCIF Field and Frame Formats - VP3 Mode On, Extra Black Lines On

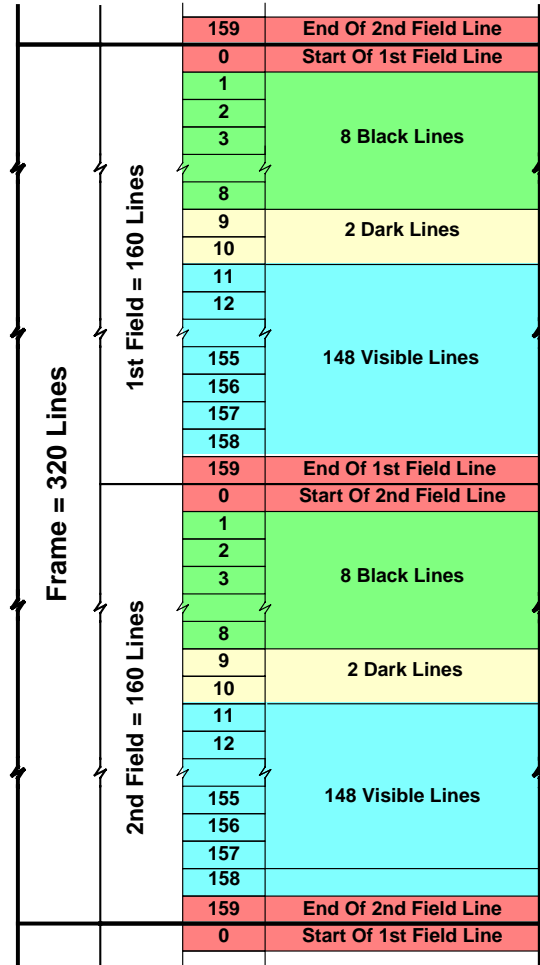
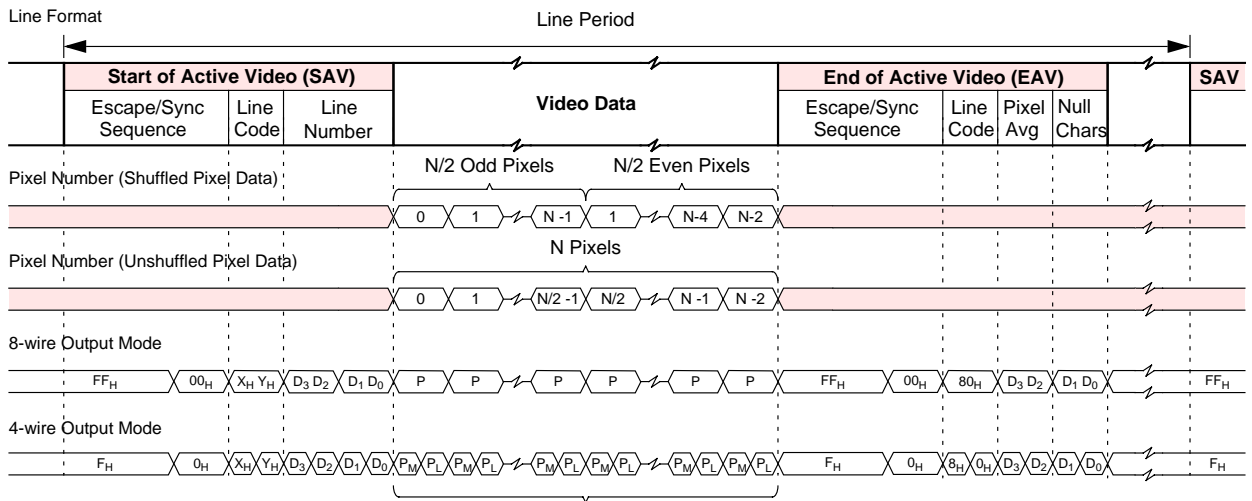

Figure 25 : QCIF Field and Frame Formats - VP3 Mode Off



- (i) Blanking Line (BL) P = Blanking Level (07_H)
- (ii) Black Line (BK) P = Valid Black Pixel Data
- (iii) Visible Line (VL) P = Valid Pixel Data
- (iv) Start of Frame (SOF) P = Sensor Status Data, data at pixel position 0 and 1 set to blanking level, 07_H.
- (v) End of Frame (EOF) P = Blanking Level (07_H)

Figure 26 : Line Data Format.

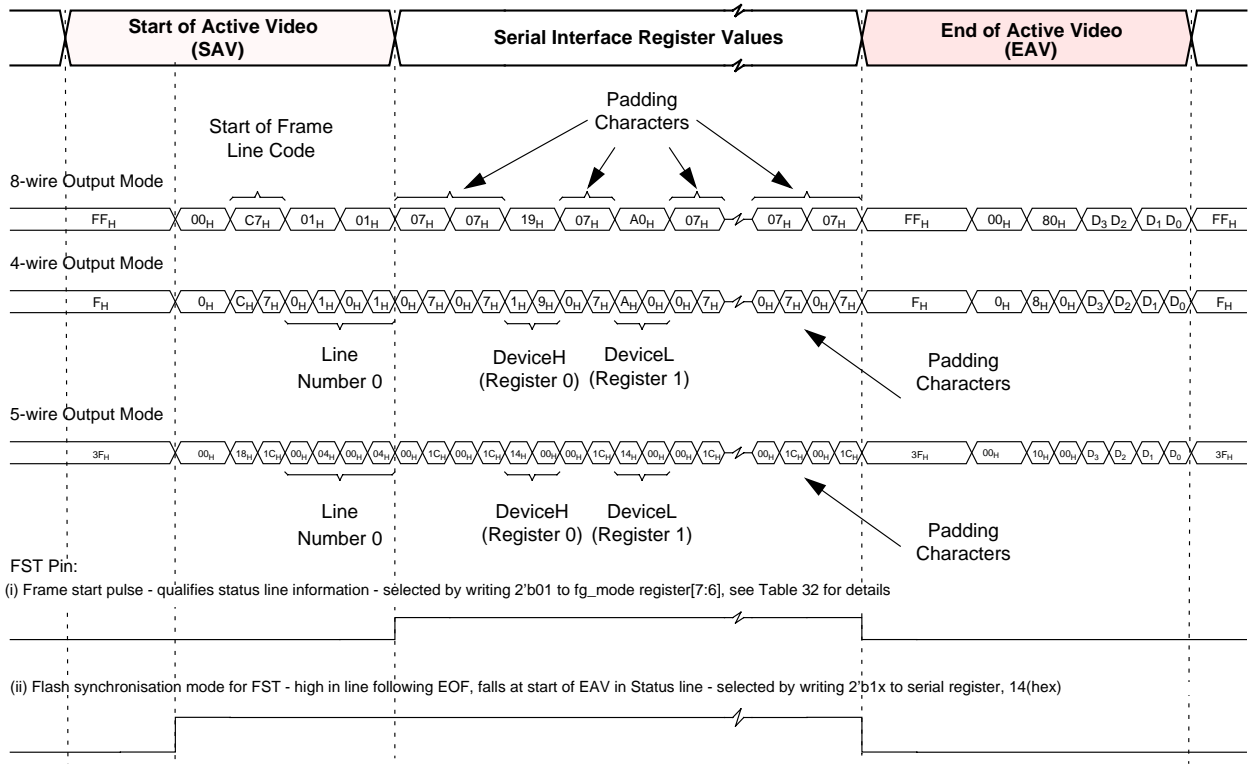

Figure 27 : Status Line Data Format and FST Signals

Commercial in confidence

cd5410-6410f3-0.fm

47/105



8.3.4 Valid video line timing

All valid video data is contained on active video lines. The pixel data appears as a continuous stream of bytes within the active lines. The pixel data may be separated from the line header and end-of-line control sequence by a number of 'blank' bytes (07_H).

8.3.5 Start of frame line timing

The start of frame line which begins each video field contains no video data but instead contains the contents of the serial interface register map. Immediately following the SAV sequence there are 2 padding pixels, (see Figure 27), output as blanking levels, (07_H). There will be more blanking codes output after all the serial interface registers have been output. The padding pixels continue to be output until terminated by an end-of-line control sequence. To ensure that no escape/sync characters, (the reserved FF,FF,00 sequence), appear in the sensor status/configuration information the code 07_H is output after each serial interface value.

If a serial interface register location is unused then a default value, the DeviceH register, is output. The read-out order of the registers is independent of whether the pixel read-out order is shuffled or un-shuffled.

8.3.6 End of frame line timing

The end of frame line contains no video data. Its sole purpose is to indicate the end of a frame.

8.4 Detection of sensor using data bus state

On power-up a sensor will pull all data lines high and these lines will remain high while the device is in the power up default, low power state. The device is removed from this low power mode by the I2C host writing to sensor register, setup0 [address 10₁₆]. When the device exits the low power mode it will follow a defined power up sequence, please see Figure 30 for more details. Upon completion of the power up sequence the sensor will begin streaming video.

8.5 Resetting the Sensor Via the Serial Interface

Bit 2 of setup0 register allows the VV5500/VV6500 sensor to be reset to its power-on state via the serial interface. Setting this "Soft Reset" bit causes all of the serial interface registers including the "Soft Reset" bit to be reset to their default values. This "Soft Reset" leaves the sensor in low-power mode.

8.6 Resetting the Sensor Via the RESETB pin

On power-up the RESETB pin is configured as an active low system reset which has the same effect as a soft reset issued via the serial interface as described above.

8.7 Resynchronising the Sensor Via the RESETB pin configured as SINB

Bit 5 of the pin mapping register [21] allows the RESETB pin to be re-configured as an active low (edge triggered) system synchronisation signal which will reset the video timing to the beginning of a field but will NOT reset the serial registers therefore the host does not have to reconfigure the sensor following a resynchronisation.

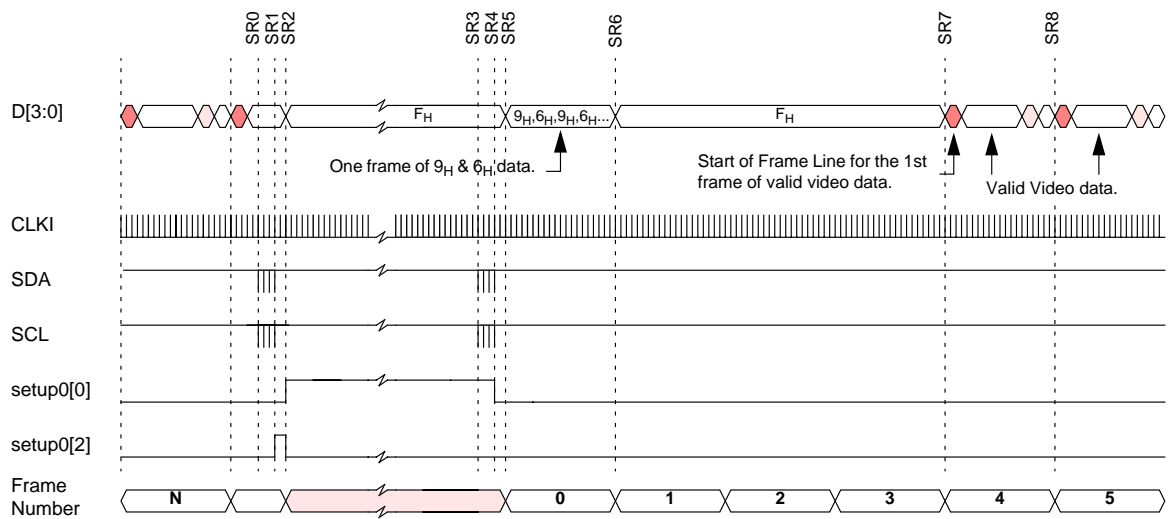

SR0-SR1	"Soft-Reset" Command. At the end of the command the sensor is reset and enters low-power mode.
SR2	The sensor enters low-power mode.
SR3-SR4	"Exit Low Power Mode" Command. Powers-up analogue circuits and initiates the sensor's 4-frame start-up sequence
SR5-SR6	1 Frame of alternating 9 _H & 6 _H data on D[3:0] for the host to determine the best sampling phase for the nibble data (D[3:0]).
SR7-SR8	4 Frames after the "Exit Low-Power mode" command, the sensor starts outputting valid video data.

Figure 28 : Resetting the Sensor via the Serial Interface (example shown is 4wire output mode)



8.8 Power-up, Low-power and Sleep modes

Please note that the following descriptions of low power and sleep modes assumes that the user has selected the optional 4 wire output mode, that is D[3:0] will transmit the digital video data. If the 5-wire or 8-wire modes are selected the same basic behaviour is followed however the contents of the data bus will differ slightly.

PU0	System Power Up
PU1	Sensor enters low power mode and databus bits driven high.
PU2	Host enables the sensor clock, CLKI.
PU3-PU4	The host sends a "Soft-Reset" command to the sensor via the serial interface. This ensures that the sensor is in low-power mode.
PU5	Host issues command to remove sensor from low-power mode.
PU6-PU7	Sensors begins execution 4 frame start sequence.
PU8-PU9	One frame of alternating 9_H & 6_H data on D[3:0] for the host to determine the best sampling phase for video data.
PU10-PU11	4 Frames after the "Exit Low-Power Mode" serial comms, the sensor starts outputting valid video data.

Table 15 : Typical System Power-Up

8.8.1 Power-Up/Down (Figure 29)

The sensor enters low-power mode on power-up. On power-up all of the data bus lines are driven high immediately and the device is in low-power mode (Section 8.8.2).

The sensor will remain in the low power mode until the external host sends the appropriate message over I2C to clear the low power bit - bit0 of serial register, setup0, index 10_{16} .

After the "Exit Low-Power Mode" command has been sent the sensor will output for one frame, a continuous stream of alternating 9_H and 6_H values on D[3:0]. The patterns generated in 5 and 8 wire modes are given in Table 16 below. By locking onto the resulting 0101/1010 patterns appearing on the data bus lines the host can determine the best sampling position for the nibble data. After the last 9_H 6_H pair has been output the data bus returns to F_H ($1F_H$ in 5 wire mode), until the start of fifth frame. At this point the first active video frame will be output. After the host has determined the correct sampling position for the data, it should then wait for the next start of frame line (SOF).

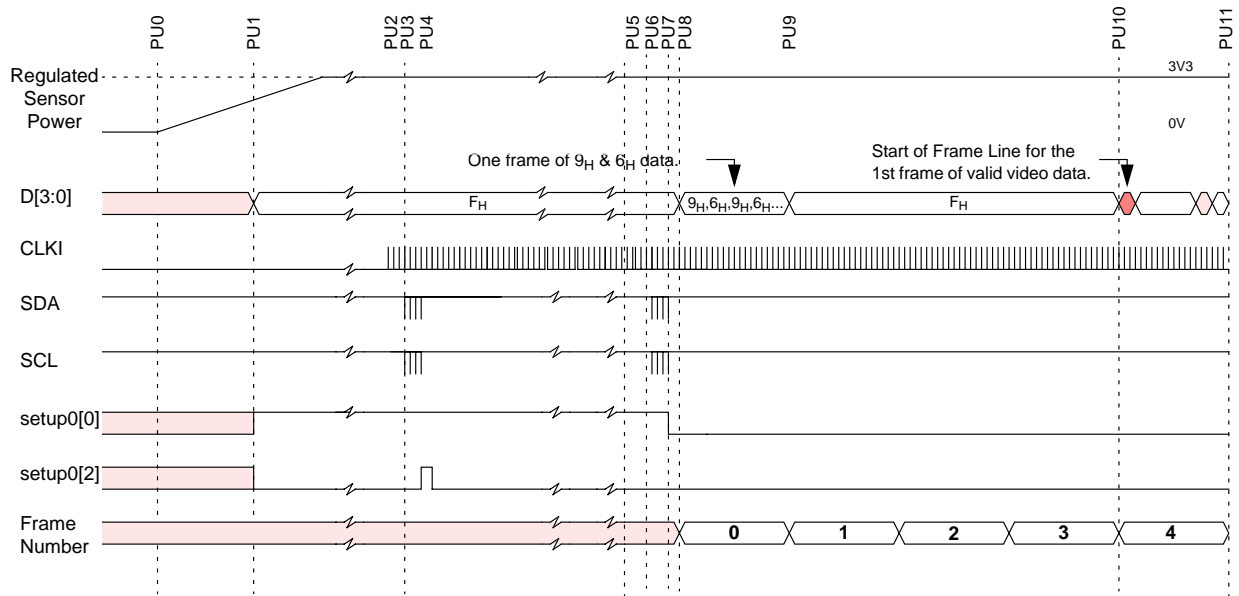

Figure 29 : Typical System Power-Up Procedure



cd5410-6410f3-0.fm

Commercial in confidence

5/1/05

Mode	10-bit Value	Output Data Bus Pattern
4-Wire	258 _H	9 _H /6 _H (1001 ₂ /0110 ₂)
5-Wire	136 _H	09 _H /16 _H (01001 ₂ /10110 ₂)
8-Wire	096 _H / 069 _H	25 _H /1A _H (00100101 ₂ /00011010 ₂)

Table 16 : Output Data Bus Patterns for determination of Best Sampling Position

8.8.2 Low-Power Mode (Figure 30)

Under the control of the serial interface the sensor analog circuitry can be powered down and then repowered. When the low-power bit is set via the serial interface, all the data bus lines will go high at the end of the end of frame line of the current frame. At this point the analog circuits in the sensor will power down. The system clock must remain active for the duration of low power mode.

During low power mode only the analog circuits are powered down, the values of the serial interface registers e.g. exposure and gain are preserved. The internal frame timing is reset to the start of a video frame on exiting low-power mode. In a similar manner to the previous section, the first frame after the serial comms contains a continuous stream of alternating 9_H and 6_H - or equivalent for the alternative output databus widths - to allow the host to re-confirm its sampling position. Then three frames later the first start of frame line is generated.

8.8.3 Sleep Mode

Sleep mode is similar to the low-power mode, except that analog circuitry remains powered. When the sleep command is received via the serial interface the pixel array will be put into reset and the data lines all will go high at the end of the current frame. Again the system clock must remain active for the duration of sleep mode.

When sleep mode is disabled, the CMOS sensor's frame timing is reset to the start of a frame. During the first frame after exiting from sleep mode the data bus will remain high, while the exposure value propagates through the pixel array. At the start of the second frame the first start of field line will be generated.

8.8.4 System clock status during sensor low-power modes

To allow the sensor to enter and exit the low power and sleep modes the system clock, CLKI, must be active.

8.9 Suspend mode

Under the control of the SUSPEND pin VV5410/VV6410 can be forced into an ultra low power mode. The sensor will consume less than 80uA of current while suspended. While the sensor is in this mode video output is turned off and no serial communications can occur.

The SUSPEND mode is effectively identical to a power on reset - all the video timing blocks within the sensor are reset as are the contents of the serial interface, therefore the user will have to perform a complete reconfiguration of the device on exiting SUSPEND. The sensor will also repeat the full 4 field power up sequence.

Mode	Description	Approx. Sensor Current
Suspend	Sensor in lowest power state. Suspend has been asserted by host.	c.80uA

Table 17 : VV5410/VV6410 suspend mode power consumption

8.10 Data Qualification Clock, QCK

VV5410/VV6410 provides a data qualification clock, (see Figure 31), to qualify the information output on data bus. The sensor can generate two styles of qualification clock:

- Fast QCK, clocks at nibble rate. The falling edge of this clock qualifies data

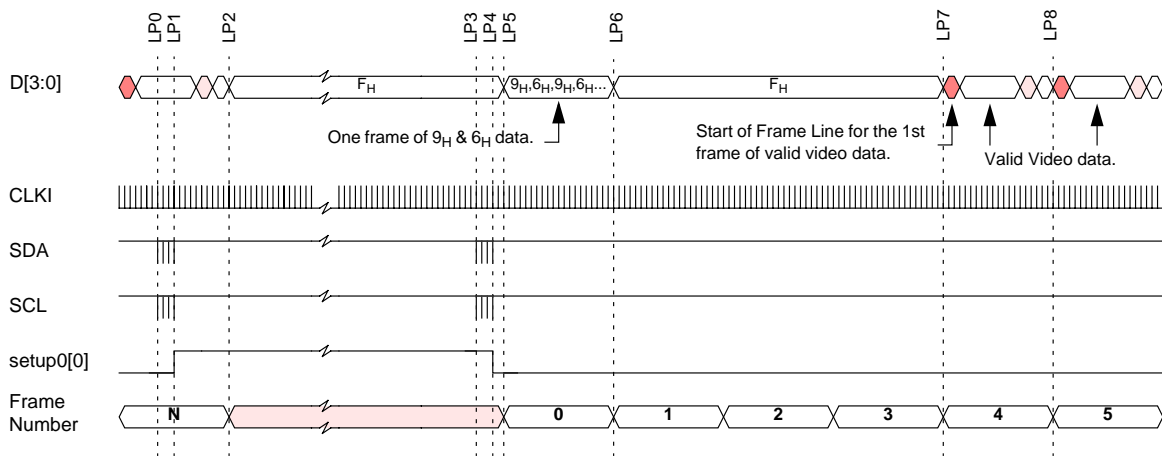

LP0-LP1	"Enter Low Power Mode" Command.
LP2	At end of current frame, the sensor will enter the low power mode and the databus will be driven high.
LP3-LP4	"Exit Low Power Mode" Command sent to sensor - sensor begins power up sequence.
LP5-LP6	1 Frame of alternating 9 _H & 6 _H data on D[3:0] for the host to determine the best sampling phase for the nibble data (D[3:0]).
LP7-LP8	4 Frames after the "Exit low Power Mode" command, the sensor starts outputting valid video data.

Figure 30 : Entering and Exiting Low Power Mode (example is 4wire mode).



- The slow QCK, clocks at pixel rate. Both the falling and rising edge of this clock are used to qualify data. The most significant data nibble is qualified by the rising edge of the slow QCK and the least significant nibble is qualified by the falling edge of the slow QCK.

There are 4 modes of operation of QCK.

1. Disabled (Always low - default mode of operation)
2. Free running - qualifies the entire output data stream.
3. Qualify embedded control sequences, status data, (from the SOF line), and pixel data.
4. Qualify pixel data only, (this will include data from the black lines).

The operating mode for QCK is set via the serial interface. The QCK output can be tri-stated either when OEB is driven high or via the appropriate control bit in the serial interface, (see data_format register[22]).

The QCK pin can also be configured to output the state of a serial interface register bit. This feature allows the sensor to control external devices, e.g. stepper motors, shutter mechanisms.

Full details of how to configure the QCK output pin can be found in 2 registers, fg_mode[20] and pin_mapping[21].

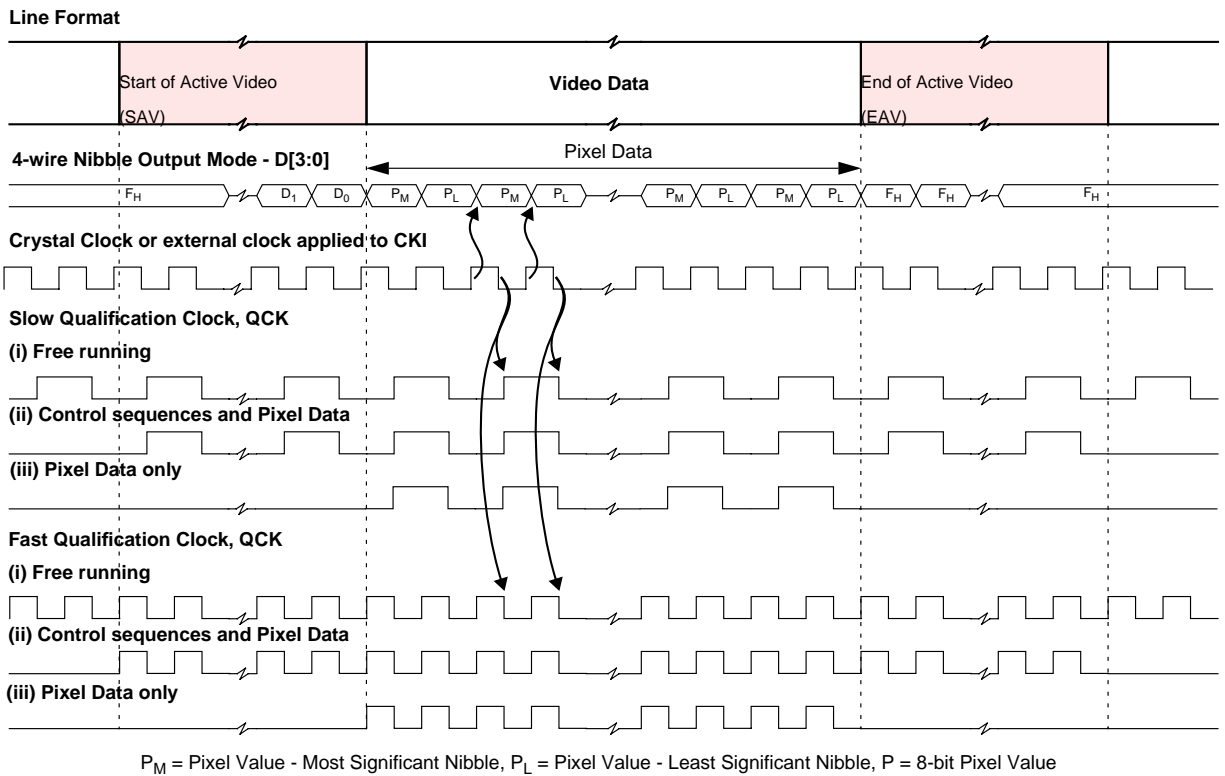

Figure 31 : Qualification of Output Data (Border Rows and Columns Enabled).



cd5410-6410f3-0.fm

Commercial in confidence

55/105

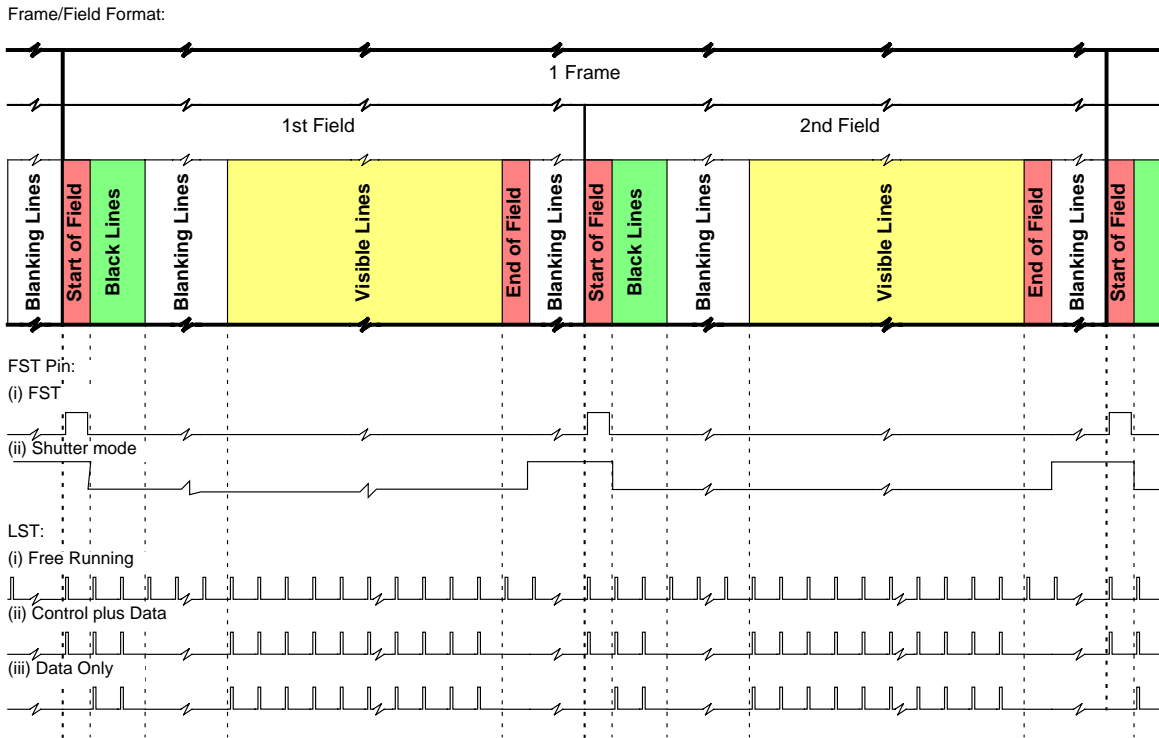

Figure 32 : Frame/Field Level Timings for FST and LST.

8.10.5 Line Start Signal, LST

There are 4 modes of operation for the LST pin programmable via the serial interface, (see fg_mode[20]):

1. Disabled (Always Low- Default).
2. Free running - LST signal occurs once at the beginning of every line.
3. All lines except blanking lines are qualified by LST.
4. Only Black and Visible Lines are qualified by LST.

The LST is tri-stated either when OEB is driven high or via the appropriate control bit in the serial interface, (see data_format register[22]). Table 18 below details the LST timing for the different video modes, (see Figure 33 for specification of t1 and t2).

Video Mode	t1		t2	
	pck's	us	pck's	us
CIF	21	5.25	16	4.000
QCIF (both pan tilt and sub sampled, 16Mhz clock)	6	6.00	15	15.00
QCIF (both pan tilt and sub sampled, 8Mhz clock)	6	6.00	15	15.00
PAL	33	4.652	42	5.962
NTSC	27	4.714	12	2.095

Table 18 : LST Timing

8.10.6 Frame Start Signal, FST

There are 3 modes of operation for the FST pin programmable via the serial interface:

1. Disabled (Always Low- Default).
2. Frame start signal. The FST signal occurs once frame, is high for 356 pixel periods (712 system clock periods) and qualifies the data in the start of frame line.
3. Shutter/Electronic Flash Synchronisation Signal - FST rises at the start of the video data in the first black/blank line after the EOF line and falls at the end of data in the SOF line.

The FST output is tri-stated either when OEB is driven high or via the appropriate control bit in the serial interface, (see data_format register[22]).

The configuration details for FST can be found in fg_mode register[20].

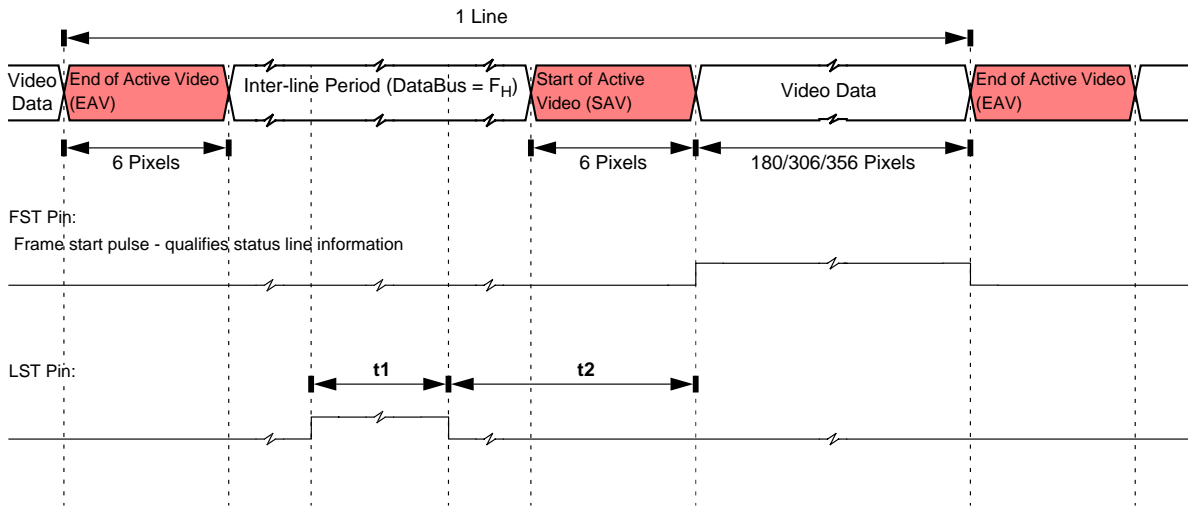

Figure 33 : Line Level Timings for FST and LST.

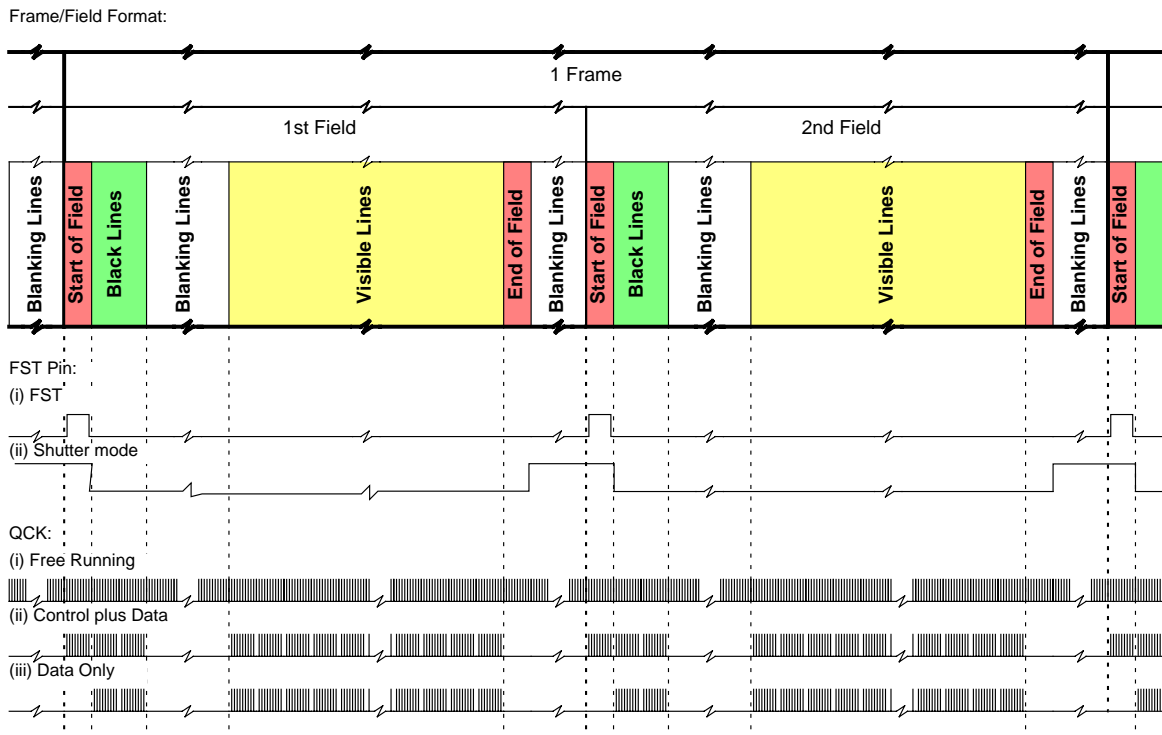

Figure 34 : Frame/Field Level Timings for FST and QCK.



cd5410-6410f3-0.fm

Commercial in confidence

59/105

9. Serial Control Bus

9.1 General Description

Writing configuration information to the video sensor and reading both sensor status and configuration information back from the sensor is performed via the 2-wire serial interface.

Communication using the serial bus centres around a number of registers internal to the video sensor. These registers store sensor status, set-up, exposure and system information. Most of the registers are read/write allowing the receiving equipment to change their contents. Others (such as the chip id) are read only.

The main features of the serial interface include:

- Variable length read/write messages.
- Indexed addressing of information source or destination within the sensor.
- Automatic update of the index after a read or write message.
- Message abort with negative acknowledge from the master.
- Byte oriented messages.

The contents of all internal registers accessible via the serial control bus are encapsulated in each start-of-field line - see Section 8.3.5.

9.2 Serial Communication Protocol

The co-processor or host must perform the role of a communications master and the camera acts as either a slave receiver or transmitter. The communication from host to camera takes the form of 8-bit data with a maximum serial clock host frequency of up to 100 kHz. Since the serial clock is generated by the bus master it determines the data transfer rate. Data transfer protocol on the bus is illustrated in Figure 35.

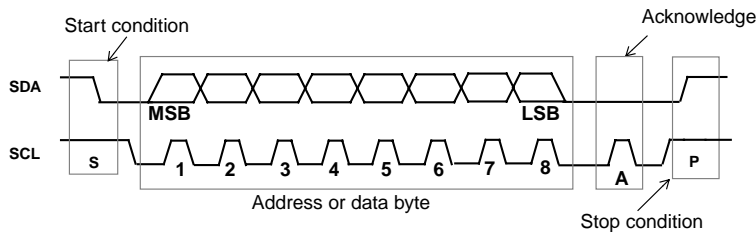

Figure 35 : Serial Interface Data Transfer Protocol

9.3 Data Format

Information is packed in 8-bit packets (bytes) always followed by an acknowledge bit. The internal data is produced by sampling *sda* at a rising edge of *scl*. The external data must be stable during the high period of *scl*. The exceptions to this are start (S) or stop (P) conditions when *sda* falls or rises respectively, while *scl* is high.

A message contains at least two bytes preceded by a start condition and followed by either a stop or repeated start, (Sr) followed by another message.

The first byte contains the device address byte which includes the data direction *read*, (*r*), *~write*, (*~w*), bit. The lsb of the address byte indicates the direction of the message. If the lsb is set high then the master will read data from the slave and if the lsb is reset low then the master will write data to the slave. After the *r*, *~w* bit is sampled, the data direction cannot be changed, until the next address byte with a new *r*, *~w* bit is received.

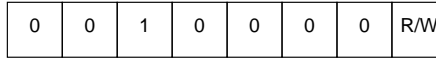

Figure 36 : VV5410/VV6410's Serial Interface Address

The byte following the address byte contains the address of the first data byte (also referred to as the *index*). The serial interface can address up to 128, byte registers. If the msb of the second byte is set the automatic increment feature of the address index is selected.

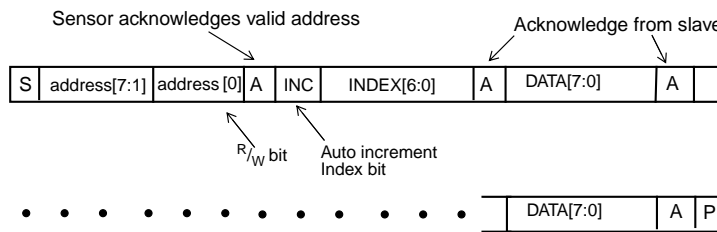

Figure 37 : Serial Interface Data Format

9.4 Message Interpretation

All serial interface communications with the sensor must begin with a *start* condition. If the *start* condition is followed by a valid address byte then further communications can take place. The sensor will acknowledge the receipt of a valid address by driving the *sda* wire low. The state of the *read/write* bit (lsb of the address byte) is stored and the next byte of data, sampled from *sda*, can be interpreted.

During a write sequence the second byte received is an address index and is used to point to one of the internal registers. The msbit of the following byte is the *index auto increment* flag. If this flag is set then the serial interface will automatically increment the index address by one location after each slave acknowledge. The master can therefore send data bytes continuously to the slave until the slave fails to provide an acknowledge or the master terminates the write communication with a *stop* condition or sends a *repeated start*, (*Sr*). If the auto increment feature is used the master does *not* have to send indexes to accompany the data bytes.

As data is received by the slave it is written bit by bit to a serial/parallel register. After each data byte has been received by the slave, an acknowledge is generated, the data is then stored in the internal register addressed by the current index.

During a read message, the current index is read out in the byte following the device address byte. The next byte read from the slave device are the contents of the register addressed by the current index. The contents of this register are then parallel loaded into the serial/parallel register and clocked out of the device by *scl*.

At the end of each byte, in both read and write message sequences, an acknowledge is issued by the receiving device. Although VV5410/VV6410 is always considered to be a slave device, it acts as a transmitter when the bus master requests a read from the sensor.

At the end of a sequence of incremental reads or writes, the terminal index value in the register will be one *greater* the last location read from or written to. A subsequent read will use this index to begin retrieving data from the internal registers.

A message can only be terminated by the bus master, either by issuing a stop condition, a repeated start condition or by a negative acknowledge after reading a complete byte during a read operation.

9.5 The Programmers Model

There may be up to 128, 8-bit registers within the camera, accessible by the user via the serial interface. They are grouped



according to function with each group occupying a 16-byte page of the location address space. There may be up to eight such groups, although this scheme is purely a conceptual feature and not related to the actual hardware implementation, The primary categories are given below:

- Status Registers (Read Only).
- Setup registers with bit significant functions.
- Exposure parameters that influence output image brightness.
- System functions and analog test bit significant registers.

Any internal register that can be written to can also be read from. There are a number of read only registers that contain device status information, (e.g. design revision details).

Names that end with H or L denote the most or least significant part of the internal register. Note that unused locations in the H byte are packed with zeroes.

STMicroelectronics sensors that include a 2-wire serial interface are designed with a common address space. If a register parameter is unused in a design, but has been allocated an address in the generic design model, the location is referred to as **reserved**. If the user attempts to read from any of these **reserved or unused** locations a default byte will be read back. In VV5410/VV6410 this data is 19_H. A write instruction to a reserved (but unused) location is illegal and would not be successful as the device would not allocate an internal register to the data word contained in the instruction.

A detailed description of each register follows. The address indexes are shown as decimal numbers in brackets [...] and are expressed in decimal and *hexadecimal* respectively.

Index ₁₀	Index ₁₆	Name	Length	R/W	Default	Comments
Status Registers - [0-15]						
0	0	deviceH	8	RO	0001_1001 ₂	Chip identification number including revision indicator
1	1	deviceL	8	RO	1010_0000 ₂	
2	2	status0	8	RO	0001_0000 ₂	User can determine whether timed serial interface data has been consumed by interrogating flag states
3	3	line_countH	8	RO	n/a	Current line counter value
4	4	line_countL	8	RO	n/a	
5	5	xendH	1	RO	359	End x coordinate of image size
6	6	xendL	8	RO		
7	7	yendH	1	RO	293	End y coordinate of image size
8	8	yendL	8	RO		
9	9	dark_avgH	4	RO	0	This is the average pixel value returned from the dark line offset cancellation algorithm (2's complement notation)
10	A	dark_avgL	8	RO	0	
11	B	black_avgH	4	RO	0	This is the average pixel value returned from the black line offset cancellation algorithm (2's complement notation)
12	C	black_avgL	8	RO	0	
13	D	status1	2	RO	00	Flags to indicate whether the x or y image coordinates have been clipped
14-15	E-F	unused				
Setup Registers - [16-31]						

Table 19 : Serial Interface Address Map.

Index ₁₀	Index ₁₆	Name	Length	R/W	Default	Comments
16	10	setup0	8	R/W	0000_1001 ₂	Low-power/sleep modes & video timing
17	11	setup1	8	R/W	1100_0000 ₂	Various parameters
18	12	sync_value	8	R/W	0001_1111 ₂	Contains pixel counter reset value used by external sync
19	13	reserved				
20	14	fg_modes	8	R/W	0000_0000 ₂	Frame grabbing modes (FST, LST and QCK)
21	15	pin_mapping	7	R/W	000_1000 ₂	FST and QCK mapping modes.
22	16	data_format	8	R/W	0000_0001 ₂	Data resolution
23	17	op_format	7	R/W	001_1000 ₂	Output coding formats
24	18	mode_select	2	R/W	01 ₂	Various mode select bits
25 - 31	19-1F	unused				
Exposure Registers - [32-47]						
32	20	fineH	2	R/W	0	Fine exposure.
33	21	fineL	8	R/W		
34	22	coarseH	2	R/W	302	Coarse exposure
35	23	coarseL	8	R/W		
36	24	analog gain	8	R/W	1111_0000	Analog gain setting
37	25	clk_div	4	R/W	0	Clock division
38-43	26-2B	reserved				
44	2C	dark offsetH	3	R/W	0	dark line offset cancellation value
45	2D	dark offsetL	8	R/W		(2's complement notation)
46	2E	dark offset setup	7	R/W	0110 0001 ₂	dark line offset cancellation enable
47	2F	reserved				
Colour Registers - [48-79]						
48 - 79	30-4F	reserved	8	R/W		
Video Timing Registers - [80-103]						
80-81	50-51	reserved				
82	52	line_lengthH	2	R/W	415	Line Length (Pixel Clocks)
83	53	line_lengthL	8	R/W		
84 - 86	54-56	reserved				
87	57	x-offsetH	1	R/W	5	x-co-ordinate of top left corner of region of interest (x-offset)
88	58	x-offsetL	8	R/W		
89	59	y-offsetH	1	R/W	3	y-co-ordinate of top left corner of region of interest (y-offset)
90	5A	y-offsetL	8	R/W		
91 - 96	5B-60	reserved				
97	61	field_lengthH	2	R/W	319	Field length (Lines)
98	62	field_lengthL	8	R/W		
99-102	63-66	reserved				
103	67	unused		R/W		
Text Overlay Registers - [104-107]						
104 - 105	68-69	reserved				
106 - 107	6A-6B	unused				

Table 19 : Serial Interface Address Map.



Index ₁₀	Index ₁₆	Name	Length	R/W	Default	Comments
Serial Interface Autoload Registers - [108-111]						
108 - 109	6C-6D	reserved				
110 - 111	6E-6F	unused				
System Registers - [112-127]						
112	70	black offsetH	3	R/W	- 64	black offset cancellation default value (2's complement notation)
113	71	black offsetL	8	R/W		
114	72	black offset setup	6	R/W	0011 0001 ₂	black offset cancellation setup
115	73	unused				
116	74	reserved				
117	75	cr0	8	R/W	0000 0000 ₂	Analog Control Register 0
118	76	cr1	8	R/W	0000 0000 ₂	Analog Control Register 1
119	77	as0	8	R/W	0101 1010 ₂	ADC Setup Register
120	78	at0	8	R/W	0000 0000 ₂	Analog Test Register
121	79	at1	8	R/W	0000 0001 ₂	Audio Amplifier Setup Register
122 - 125	7A-7D	unused				
126	7E	reserved				
127	7F	reserved				

Table 19 : Serial Interface Address Map.

9.5.1 Status Registers - [0 - 15],[0-F]

[0-1],[0-1] - DeviceH and DeviceL

These registers provide read only information that identifies the sensor type that has been coded as a 12bit number and a 4bit mask set revision identifier. The device identification number for VV5410/VV6410 is 410 i.e. 0001 1001 1010₂. The initial mask revision identifier is 0 i.e. 0000₂.

Bits	Function	Default	Comment
7:0	Device type identifier	0001 1001 ₂	Most significant 8 bits of the 12 bit code identifying the chip type.

Table 20 : [0],[0] - DeviceH

Bits	Function	Default	Comment
7:4	Device type identifier	1010 ₂	Least significant 4 bits of the 12 bit code identifying the chip type.
3:0	Mask set revision identifier	0000 ₂	

Table 21 : [1],[1] - DeviceL

[2],[2] - Status0

Bit	Function	Default	Comment
0	Fine exposure value update pending	0	Fine exposure value sent but not yet consumed by the sensor

Table 22 : [2],[2] - Status0

Bit	Function	Default	Comment
1	Coarse exposure value update pending	0	Coarse exposure value sent but not yet consumed by the sensor
2	Gain value update pending	0	Gain value sent but not yet consumed by the sensor
3	Clock division update pending	0	Clock divisor sent but not yet consumed by the sensor
4	Odd/even frame	1	The flag will toggle state on alternate frames
5	Pan image parameters pending	0	Pan image parameters sent but not yet consumed by the sensor
6	Tilt image parameters pending	0	Tilt image parameters sent but not yet consumed by the sensor
7	Video timing parameter update pending flag	0	Video timing parameters sent but not yet consumed by sensor

Table 22 : [2],[2] - Status0

[3-4],[3-4] - Line_countH & Line_countL

Register Index	Bits	Function	Default	Comment
3	0	Current line count MSB	-	Displays current line count
4	7:0	Current line count LSB	-	

Table 23 : [3-4],[3-4] - Current Line Counter Value.

[5-6],[5-6] - XendH & XendL

Register Index	Bits	Function	Default	Comment
5	0	Xend msb's	359	These registers contain the end x coordinate of the read out image size, (the x offset register contains the start x coordinate)
6	7:0	Xend ls byte		

Table 24 : [5-6],[5-6] - Xend

[7-8],[7-8] - YendH & YendL

Register Index	Bits	Function	Default	Comment
5	0	Yend ms bits	293	These registers contain the end y coordinate of the read out image size, (the y offset register contains the start y coordinate)
6	7:0	Yend ls byte		

Table 25 : [7-8],[7-8] - Yend

[9-12],[9-C] - Black_Avg & Dark_Avg

Register Index	Bits	Function	Default	Comment
9	3:0	Dark avg ms bits	0	The calculated pixel average over a series of dark lines (1,2 or 4 lines). The pixel sample size from each dark line will be image size dependent up to a maximum of 256 The average value is a signed 12 bit number
10	7:0	Dark avg ls byte	0	
11	3:0	Black avg ms bits	0	The calculated pixel average over a series of black lines (4 or 8 lines). The pixel sample size from each black line will be image size dependent up to a maximum of 256 The average value is a signed 12 bit number
12	7:0	Black avg ls byte	0	

Table 26 : [9-12],[9-C] - Black & Dark Averages**[13],[D] - Status1 Register**

Bit	Function	Default	Comment
0	X image parameters clipped	0	If this bit is set then the current x offset parameter requested has caused the x coordinates to be clipped
1	Y image parameters clipped	0	If this bit is set then the current y offset parameter requested has caused the y coordinates to be clipped
7:2	unused	000000	

Table 27 : [13],[D] - Status1**[14-15],[E-F] - unused****9.5.2 Setup Registers - [16 - 31],[10-1F]****[16],[10] - Setup0**

[

Bit	Function	Default	Comment
0	Low Power Mode: Off / On	1	Powers down the sensor array. The output data bus goes to F _H . On power-up the sensor enters low power mode.
1	Sleep Mode: Off / On	0	Puts the sensor array into reset. The output data bus goes to F _H .

Table 28 : [16],[10] - Setup0

Bit	Function	Default	Comment
2	Soft Reset Off / On	0	Setting this bit resets the sensor to its power-up defaults. This bit is also reset.
3	Frame/Field Rate select: 25 fps (PAL) / 30 fps (NTSC)	1	
5:4	reserved	00	
7:6	Video Timing Mode Select	00	00 - CIF Timing Modes 01 - PAL/NTSC 3.2 fsc Timing Modes 10 - pan/tilt/QCIF Timing Modes <i>If this mode is selected a QCIF size image will be output. The coordinates which define the top left corner of the QCIF portion of the array to be output are defined by the parameters in registers 88 - 91 inclusive. By default the x- and y-sizes of the output image are 180 & 148 respectively.</i> 11 - sub-sampled QCIF Timing Modes <i>If this mode is selected a QCIF size image will be output. The CIF image is sub-sampled in groups of 4 to preserve the Bayer pattern with every second group of pixels & lines skipped.</i>

Table 28 : [16],[10] - Setup0

Video Mode	setup0 [7:6]	setup0 [3]	System Clock Divisor	Video Data	Line Length	Field Length	Data Format (default)	Comment
1	00	0	4	356 x 292	500	320	5-wire	CIF 25fps
2		1	4	356 x 292	416	320	5-wire	CIF 30fps
3	01	0	2	356 x 292	454	312/313	5-wire	PAL (3.2 fsc)
4		1	2	306 x 244	364	262/263	5-wire	NTSC (3.2 fsc)
5	10	0	8	180 x 148	250	160	5-wire	pan/tilt QCIF 25fps
6		1	8	180 x 148	208	160	5-wire	pan/tilt QCIF 30fps
7	11	0	8	180 x 148	250	160	5-wire	sub-sampled QCIF 25fps
8		1	8	180 x 148	208	160	5-wire	sub-sampled QCIF 30fps

Table 29 : Video Timing Modes

[17],[11] - Setup1

Bit	Function	Default	Comment
2:0	reserved	000	
3	Enable immediate clock division update. Off/On	0	Allow manual change to clock division to be applied immediately
4	Enable immediate gain update. Off/On	0	Allow manual change to gain to be applied immediately

Table 30 : [17],[11] - Setup1



Bit	Function	Default	Comment
5	Enable additional black lines (lines 3-8) Off/On	0	If enabled this bit will also enable the lines immediately following the end of frame line. This bit can only set/reset if the VP3 mode (ON) has been selected. In VP3 mode (OFF) operation all possible black lines are always output.
6	reserved	1	
7	Pixel read-out order (hshuffle) Unshuffled or Shuffled	1	It is strongly recommended to use shuffled horizontal read-out with VV6410 sensor.

Table 30 : [17],[11] - Setup1

[18],[12] - sync_reset

Bit	Function	Default	Comment
7:0	Pixel counter reset value	31	During synchronisation the pixel counter can be reset to the known value or offset by up to 255 pck's into the pixel count sequence.

Table 31 : [18],[12] - sync_reset

[19],[13] - reserved**[20],[14] - fg_modes**

Bits [3:2] of the fg_mode register are mode dependent. If the NTSC or PAL video modes are selected then the free running QCK mode will be selected. The slow QCK is selected by default, regardless of the video mode.

Bit	Function	Default	Comment
1:0	FST/QCK pin modes	00	Selection of FST, QCK pin data
3:2	QCK modes	00	00 - if CIF & QCIF mode selected 01 - if NTSC and PAL mode selected
5:4	LST modes	00	See Table 35 below for details
7:6	FST modes	00	See Table 36 below for details

Table 32 : [20],[14] - fg_modes

fg_mode[1:0]		FST pin	QCK pin
0	0	FST	Slow QCK
0	1	FST	Fast QCK
1	0	Fast QCK _{note1}	Slow QCK
1	1	Invert of Fast QCK _{note1}	Fast QCK

Table 33 : FST/QCK Pin Selection

note1: The FST pin will always output the free running version of QCK (either inverted or normal)

fg_mode[3:2]		QCK state
0	0	Off
0	1	Free Running
1	0	Valid during data and control period of line
1	1	Valid only during data period of line

Table 34 : QCK Modes

fg_mode[5:4]		LST pin
0	0	Off
0	1	Free Running
1	0	Output for black, video data and status lines
1	1	Output only for black and video data lines.

Table 35 : LST Modes

fg_mode[7:6]		FST pin
0	0	Off
0	1	Normal behaviour, FST will qualify the visible pixels in the status line
1	x	Special digital stills mode. FST will be asserted at the beginning of valid data on the line following the EOF line. FST will be cleared at the end of the visible pixels in the following status line.

Table 36 : FST Modes

The option to enable the qclk during the data and control period of the line **must not be selected if monochrome (shuffled or unshuffled) video has been selected.**

[21],[15] - pin_mapping

Bit	Function	Default	Comment
0	Map serial interface register bits values on to the QCK and FST pins Off/On	0	
1	Serial Interface Bit for QCK pin	0	
2	Serial Interface Bit for FST pin	0	
4:3	Output driver strength select	00	Default setting selects 2mA driver

Table 37 : [21],[15] - pin_mapping

Bit	Function	Default	Comment
5	Enable RESETB pin as SIN Off / On	0	On power up the RESETB pin is configured as an active low system reset which will synchronise the video timing logic and reset all serial registers to their default state. Setting this bit configures the RESETB pin as an active high system synchronisation signal (SIN) which will synchronise the video timing but will NOT reset the serial registers.
7:6	unused	0	

Table 37 : [21],[15] - pin_mapping

Mapping Enable	FST pin	QCK pin
0	FST	QCK
1	pin_mapping[2]	pin_mapping[1]

Table 38 : FST/QCK Pin Selection

oeb_composite	pin_map[4]	pin_map[3]	Comments
0	0	0	Drive strength = 2mA (Default)
0	0	1	Drive strength = 4mA
0	1	0	Drive strength = 6mA
0	1	1	unallocated
1	x	x	Outputs are not being driven therefore driver strength is irrelevant

Table 39 : Output driver strength selection

[22],[16] - data_format

Bit	Function	Default	Comment
1:0	Unused	1	
2	Line read-out order (vertical) Unshuffled or Shuffled	0	If the line read out is shuffled then all the even address rows will be read out first followed by all the odd address rows
3	Pixel read-out order (hmirror) Normal or Mirrored	0	If the pixel read out is horizontally mirrored then the columns are read out in reverse order, that is the column on the right of the sensor array will appear on the left of the displayed image and vice versa
4	Line read-out order (vertical flip) Normal or Mirrored	0	If the line read out is vertically mirrored then the rows are read out in reverse order, that is the row at the bottom of the array will appear at the top of the displayed image and vice versa.

Table 40 : [22],[16] - data_format

Bit	Function	Default	Comment
5	FST/LST Enable /Tri-state	0	The FST/LST digital outputs can be tri-stated but are enabled as outputs by default. The enabling/disabling of FST/LST can be retimed to a field boundary. The state of this control bit is always available via a serial interface read, i.e. it does not have to wait to change state at a field boundary
6	QCK Enable /Tri-state	0	The QCK output can be tri-stated independently. The enabling/disabling of QCK can be retimed to a field boundary. The state of this control bit is always available via a serial interface read, i.e. it does not have to wait to change state at a field boundary.
7	Pre clock generator divide On/Off	0	The CIF and QCIF video modes expect a recommended set of input clock frequencies, however the acceptable range of clock frequencies can be extended if this bit is set. If this bit is set then the primary input clock will be divided down by 1.5 prior to the clock generator, thus if the expected clock input is 16 MHz, we can set this bit and accept 24 MHz and achieve the same final frame rate.

Table 40 : [22],[16] - data_format

OEB pin	data_format[5]	oeb_composite	Comments
0	0	0	FST/LST outputs enabled.
0	1	1	FST/LST outputs are tri-stated by data_format[5]
1	0	1	FST/LST outputs are tri-stated by OEB pin.
1	1	1	FST/LST outputs are tri-stated.

Table 41 : FST/LST output control

OEB pin	data_format[6]	oeb_composite	Comments
0	0	0	QCK output enabled.
0	1	1	QCK output is tri-stated by op_format[6]
1	0	1	QCK output is tri-stated by OEB pin.
1	1	1	QCK output is tri-stated.

Table 42 : QCK output control

[23],[17] - op_format

Bit	Function	Default	Comment
1:0	Data format select.	0	00 - 5 wire parallel output 01 - 4 wire parallel output 1x - 8 wire parallel output <i>Note: If the 8 wire output option has been selected then the FST and LST pins will output data bits 5 and 6 respectively, normal FST and LST function is not available</i>
2	Embedded SAV/EAV Escape Sequences ¹ On / Off	0	0 - Insert Embedded Control Sequences e.g Start and End of Active Video into Output Video data 1 - Pass-through mode. Output Video data equals ADC data.
4:3	reserved	11	
5	Tri-state output data bus Enabled / Tri-state	0	On power up the data bus pads are enabled by default. This bit is OR'ed with the OEB pin to generate the enable signal for the data pins as detailed in Table 44
6	Re-time tri-state update. Off / On	0	Re-time new tri-state value to a field boundary. This bit affects the updating of the op_format[5] as well as data_format[6:5]
7	unused	0	

Table 43 : [23],[17] - op_format

1. Please note that if the embedded coding sequences are disabled then the FST signal is also disabled. The QCK output will continue to function IF the free running option has been selected. The LST functionality is unaffected by the state of this bit.

OEB pin	op_format[5]	oeb_composite	Comments
0	0	0	Data outputs enabled.
0	1	1	Data outputs are tri-stated by op_format[5]
1	0	1	Data outputs are tri-stated by OEB pin.
1	1	1	Data outputs are tri-stated.

Table 44 : Data bus output control

Note: oeb_composite is the logical OR of op_format[5] and the OEB pin.

[24],[18] - mode_select

This register allows the user to configure the sensor to operate with the present generation of coprocessors as well as anticipated future devices.

Bit	Function	Default	Comment
0	Coprocessor device is VP3 No/Yes	1	By default the sensor expects the coprocessor to be a VP3 device. If the sensor is not being used with a VP3 device then this bit should be reset. This bit controls the arrangement of black/dark/visible lines within the field. It does not alter timing. Please see

Table 45 : [24],[18] - Mode Select

Bit	Function	Default	Comment
1	Retro mode for gain application Off/On	0	The gain passed to the CAB comprises 2 components, IDAC[3:0] and CDAC[5:0]. If the user selects the retro mode then the IDAC value will be the inverse of the 1s gain nibble. The user is barred from writing to the ms gain nibble. In the non retro mode all 8 bits are available to program. The 2 1s bits of CDAC[5:0] are fixed at 2'b11.
2	Select log CDAC ramp Off/On	0	By default the same CDAC value is applied for the duration of every line of every field. Setting this bit causes the CDAC value to be varied during the line.
7:3			

Table 45 : [24],[18] - Mode Select

[25-31],[19-1F] - unused

9.5.3 Exposure Control Registers [32 - 47],[20-2F]

There is a set of programmable registers which controls the sensitivity of the sensor. The registers are as follows:

1. Fine exposure.
2. Coarse exposure.
3. Analog gain.
4. Clock division

Note: As we know from an explanation earlier in this document (see Section 6. for further details) the exposure control registers are not updated immediately, rather they are timed to be updated at a precise point in the field timing.

The range of some parameter values is limited and any value programmed out-with this range will be clipped to the maximum currently permitted, (the fine and coarse maximum allowable settings are set by the current line and field length respectively).

Index ₁₀	Index ₁₆	Bits	Function	Default	Comment
32	20	0	Fine MSB exposure value	0	The maximum fine exposure is line length dependent. The expressions used to calculate the maximum fine exposure for each of the default video modes, that can be selected via Setup0 register, are as follows NTSC = line length - 51 PAL = line length - 86 CIF = line length - 51 QCIF = line length - 23
33	21	7:0	Fine LSB exposure value		

Index ₁₀	Index ₁₆	Bits	Function	Default	Comment
34	22	0	Coarse MSB exposure value	302	The maximum allowable coarse exposure setting is field length dependent. We provide the maximum coarse exposure settings for each of the standard video modes. NTSC = 260 PAL = 310 CIF (25 & 30 fps) = 318 QCIF (25 & 30 fps) = 158
35	23	7:0	Coarse LSB exposure value		
36	24	7:0	Analog gain value	1111_0000	Bits [7:4] CDAC gain control CDAC default = 63 (10-bit modes) CDAC default = 31 (9-bit modes) Bits[3:0] IDAC maximum recommended IDAC value = 12.
37	25	3:0	Clock divisor value	0	The user can opt to slow the internal clocks down from their default settings. Table 47 describes the range of clock divisors that may be selected.

Table 46 : Exposure Related Registers

Clock Divisor Setting	Pixel Clock Divisor
0000	1
0001	2
0010	3
0011	4
0100	5
0101	6
0110	7
0111	8
1000	9
1001	10
1010	11
1011	12
1100	13
1101	14
1110	15

Table 47 : Clock Divisor Values

Clock Divisor Setting	Pixel Clock Divisor
1111	16

Table 47 : Clock Divisor Values

[38-43],[26-3B] - reserved

[44 - 45],[3C-3D] - Dark Pixel Offset

Bit	Function	Default	Comment
2:0	MS Dark line pixel offset	0	This register contains a fixed offset that can be applied to the digitised pixels in the digital output coding block. The offset is a 2's complement number, giving an offset range -1024,+1023. If this external offset cancellation is to be applied then it register[46], bits[1:0] should be reprogrammed to 2'b1x.
7:0	LS Dark line pixel offset		

Table 48 : [44 - 45],[3C-3D] - Dark Pixel Offset

[46],[3E] - Dark Pixel Cancellation Setup Register

Bit	Function	Default	Comment
1:0	Dark line offset cancellation	01	x0 - Accumulate dark pixels, calculate dark pixel average and report, but don't apply anything to data stream 01 - Accumulate dark pixels, calculate dark pixel average and report and apply internally calculated offset to data stream 11 - Accumulate dark pixels, calculate dark pixel average and report, but apply an externally calculated offset
2	Number of dark lines used All dark lines /Use half the number of dark lines.	0	The dark line offset cancellation algorithm can opt to only use pixels from dark lines that are preceeded by another dark line, i.e line choose only line 306 from line 305 and line 306.
5:3	reserved		
6	Use narrow dark offset deadband Yes/No	1	The deadband describes a range of dark pixel averages that will force the leaky integrator algorithm to hold it's current value. 0 - Target +/- 4 codes 1 - Target +/- 2 codes
7	unused	0	

Table 49 : [46],[3E] - Dark Pixel Cancellation Setup Register

[47],[3F] - reserved

[48-79],[30-4F] - reserved

9.5.4 Video Timing Registers [80 - 103],[50-67]

Indexes in the range [80 - 103] control the generically named video timing registers, including the image pan/tilt parameters and line & field length of the sensor. The registers are as follows:

1. line length.
2. x-offset of region of interest.

3. y-offset of region of interest.
4. frame length.

The length of a line is specified in a number of pixel clocks, whereas the length of a field is specified in a number of lines.

The range of some parameter values is limited and any value programmed out-with this range will be clipped to the maximum allowed. The x-offset and y-offset are only programmable if the user has selected the pan tilt QCIF mode. If the other video modes are selected then the x-offset and y-offset registers will have pre-programmed values applied, but they cannot be changed. The x-offset and y-offset default values are chosen such that the output image, regardless of video mode selected, will be centered within the pixel array, (see Section 3.2 for details).

Index ₁₀	Index ₁₆	Bit	Function	Default	Comment
80-81	50-51		reserved		
82	52	1:0	Line Length MSB value	415	Minimum mode dependent Maximum = 1023 Actual line duration in pixel periods is line length programmed +1.
83	53	7:0	Line Length LSB value		
84 - 86	54-56		reserved		
87	57	0	x-offset MSB value	5	Minimum (positive) value = 1
88	58	7:0	x-offset LSB value		
89	59	0	y-offset MSB value	3	Minimum (positive) value = 1
90	5A	7:0	y-offset LSB value		
91 - 96	5B-60		reserved		
97	61	1:0	Field Length MSB value	319	Minimum mode dependent Maximum = 1023 Actual field duration in line periods is field length programmed +1.
98	62	7:0	Field Length LSB value		
99-102	63-66		reserved		

Table 50 : Video Timing Registers

[103],[67] - unused

[104-105],[68-69] - reserved

[106-107],[6A-6B] - unused

[108-109],[6C-6D] - reserved

[110-111],[6E-6F] - unused

9.5.5 System Registers -Addresses [112 - 127],[70-7F]

This page of the serial interface I2C address space comprises a wide range of registers including the registers required to control the black offset cancellation algorithm, enable test modes and also control various aspects of the analogue behavior of the sensor.

[112 - 113],[70-71] - Black Pixel Offset

Bit	Function	Default	Comment
2:0	MS Black line pixel offset	- 64	This register contains a fixed offset that can be applied to the digitised pixels in the digital output coding block. The offset is a 2's complement number, giving an offset range -1024,+1023. If this external offset cancellation is to be applied then it register[114], bits[1:0] should be reprogrammed to 2'b1x.
7:0	LS Black line pixel offset		

Table 51 : [112 - 113],[70-71] - Black Pixel Offset**[114],[72] - Black Pixel Cancellation Setup Register**

Bit	Function	Default	Comment
1:0	Black line offset cancellation	01	x0 - Accumulate black pixels, calculate black pixel average and report, but don't apply anything to data stream 01 - Accumulate black pixels, calculate black pixel average and report and apply internally calculated offset to data stream 11 - Accumulate black pixels, calculate black pixel average and report, but apply an externally calculated offset
4:2	reserved	100	The time constant controls the rate at which a change in the black level is corrected for.
5	Use narrow black offset deadband Yes/No	1	The deadband describes a range of pixel averages that will cause the leaky integrator algorithm to hold it's current value. 0 - Target +/- 4 codes 1 - Target +/- 2 codes
7:6	unused	00	

Table 52 : [114],[72] - Black offset cancellation setup**[115],[73] - unused****[116],[74] - reserved****[117 - 118],[75-76] - Control Registers 0 and 1- CR0 and CR1**

Although we give the user access to the following 5 registers it is not anticipated that the contents of these registers will have to be altered. If the user does wish to alter any of the register bits then they are strongly advised to contact VIBU before doing so.

Bit	Function	Default	Comment
0	Enable bit line clamp Off/On	0	
1	Enable bit line test Off/On	0	

Table 53 : [117],[75] - Control Register CR0

Bit	Function	Default	Comment
3:2	Bit line white reference 0.7 V / 1.1 V / 1.5V / Ext.	00	00 - 0.7V 01 - 1.1V 10 - 1.5V 11 - External
4	Enable anti blooming Off/On	0	
5	Power Down - LVDS input comparator Off/On	0	Powers down LVDS input. CMOS clock input may still be used.
6	Power Down - SRAM Off/On	0	Powers down SRAM comparator
7	Power Down - VCCS Off/On	0	Powers down voltage controlled current source

Table 53 : [117],[75] - Control Register CR0

Bit	Function	Default	Comment
0	Stand-by Off/On	0	Powers down ALL analog circuitry with the exception of the band gap
1	Power Down - Internal Ramp Generator Off/On	0	
2	Power Down - Column ADC Off/On	0	Powers down preamp and comparators
3	Power Down - CAB regulator Off/On	0	Referred to in figures as pd_creg
4	Power Down - Audio Amplifier regulator Off/On	0	Referred to in figures as pd_areg
5	Power Down - VRT Amplifier Off/On	0	Allows external VRT to be applied
6	Ramp common mode voltage VRT-vtn/1.5V	0	0 - VRT-vtn ramp common mode voltage 1- 1.5V ramp common mode voltage
7	Current boost to column comparator 75uA/50uA	0	0 - 75uA 1- 50uA

Table 54 : [118],[76] - Control Register CR1

[119][77] - ADC Setup Register AS0

Bit	Function	Default	Comment
1:0	reserved	10	

Table 55 : [119],[77] - ADC Setup Register AS0



Bit	Function	Default	Comment
2	Enable voltage doubler Off/On	0	It is recommended that this bit is set if the sensor is being used in a 3.3V supply environment
3	Differential ramp enable Off/On	1	Ramp generator signal bpramp
4	view column/view vcmtcas vcmtcas/column	1	0 - view column voltage Vx[363] 1 - view vcmtcas
5	ramp viewing/column comparator test ramps/test comparator	0	0 -view ramps on CPOS/CNEG 1- input to test comparator 364
6	Stepped Ramp Enable Off/On	1	Setting this bit enables a stepped ramp. Clearing this bit enables a continuous ramp.
7			

Table 55 : [119],[77] - ADC Setup Register AS0

[120],[78] - Analog Test Register AT0

Bit	Function	Default	Comment
0	SRAM test enable Off/On	0	
2:1	VRT Voltage 2.2V / 2.5V / 2.8V / Ext.	00	00 - VRT = 2.2V 01 - VRT = 2.5V 10 - VRT = 2.8V 11 - reserved
4:3	LineInt & ReadInt phasing	00	00- 0 degree phase delay 01 - 90 degree phase delay 10 - 180 degree phase delay 11 - 270 degree phase delay
7:5	unused	000	

Table 56 : [120],[78] - Analog Test Register AT0**[121],[79] - Audio Amplifier Setup Register AT1**

Bit	Function	Default	Comments
0	First stage gain	1	0 - 0dB 1 - 30dB
1	Second stage gain[1]	0	gain[1] gain[0] - gain(dB)
2	Second stage gain[0]	0	0 0 - 0dB 0 1 - 6dB 1 0 - 12dB 1 1 - 18dB
3	Power Down	1	0 - Powered up 1 - Power down
4	Output Select	0	0 - Single ended 1 - Differential
5	Current Boost	0	0 - 1mA output drive in output buffers 1 - 2mA output drive in output buffers
7:6	Unused	00	

Table 57 : [121],[79] - Audio Amplifier Setup Register AT1**[122-125],[7A-7D] - unused****[126-127],[7E-7F] - reserved**

9.6 Types of messages

This section gives guidelines on the basic operations to read data from and write data to the serial interface.

The serial interface supports variable length messages. A message may contain no data bytes, one data byte or many data bytes. This data can be written to or read from common or different locations within the sensor. The range of instructions available are detailed below.

- Write no data byte, only sets the index for a subsequent read message.
- Single location data write or read for monitoring (real time control)
- Multiple location read or write for fast information transfers.

Examples of these operations are given below. A full description of the internal registers is given in the previous section. For all examples the slave address used is 32_{10} for writing and 33_{10} for reading. The write address includes the read/write bit (the lsb) set to zero while this bit is set in the read address.

9.6.1 Single location, single data write.

When a random value is written to the sensor, the message will look like this:

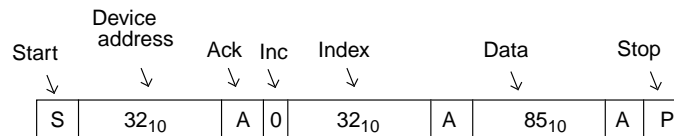

Figure 38 : Single location, single write.

In this example, the *fineH* exposure register (index = 32_{10}) is set to 85_{10} . The *r/w* bit is set to zero for writing and the *inc* (msbit of the index byte) is set to zero to disable automatic increment of the index after writing the value. The address index is preserved and may be used by a subsequent read. The write message is terminated with a stop condition from the master.

9.6.2 Single location, single data read.

A read message always contains the index used to get the first byte.

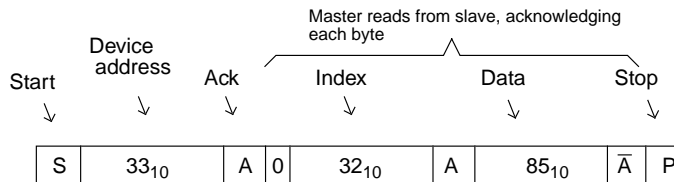

Figure 39 : Single location, single read.

This example assumes that a write message has already taken place and the residual index value is 32_{10} . A value of 85_{10} is read from the *fineH* exposure register. Note that the read message is terminated with a negative acknowledge (\bar{A}) from the master: it is not guaranteed that the master will be able to issue a stop condition at any other time during a read message. This is because if the data sent by the slave is all zeros, the *sda* line cannot rise, which is part of the stop condition.

9.6.3 No data write followed by same location read.

When a location is to be read, but the value of the stored index is not known, a write message with no data byte must be written first, specifying the index. The read message then completes the message sequence. To avoid relinquishing the serial to bus to another master a repeated start condition is asserted between the write and read messages, i.e. no stop condition is asserted. In this example, the *gain* value (index = 36₁₀) is read as 15₁₀:

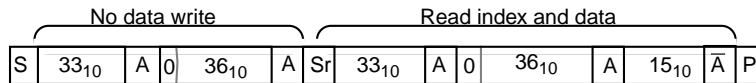

Figure 40 : No data write followed by same location read.

As mentioned in the previous example, the read message is terminated with a negative acknowledge (\bar{A}) from the master.

9.6.4 Same location multiple data write.

It may be desirable to write a succession of data to a common location. This is useful when the status of a bit (e.g. auto-load) must be toggled.

The message sequence indexes *sf_setup* register 108. If bit 0 is toggled high, low this will initiate a fresh auto-load. This is achieved by writing two consecutive data bytes to the sensor. There is no requirement to re-send the register index before each data byte.

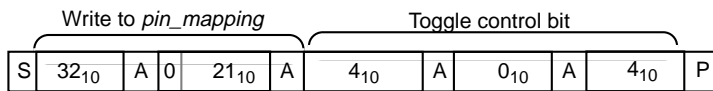

Figure 41 : Same location multiple data write.

9.6.5 Same location multiple data read

When an exposure related value (*fineH*, *fineL*, *coarseH*, *coarseL*, *gain* or *clk_div*) is written, it takes effect on the output at the beginning of the next video frame, (remember that the application of the *gain* value is a frame later than the other exposure parameters). To signal the consumption of the written value, a flag is set when any of the exposure or gain registers are written and is reset at the start of the next frame. This flag appears in *status0* register and may be monitored by the bus master. To speed up reading from this location, the sensor will repeatedly transmit the current value of the register, as long as the master acknowledges each byte read.

In the below example, a *fineH* exposure value of 0 is written, the status register is addressed (no data byte) and then constantly read until the master terminates the read message.

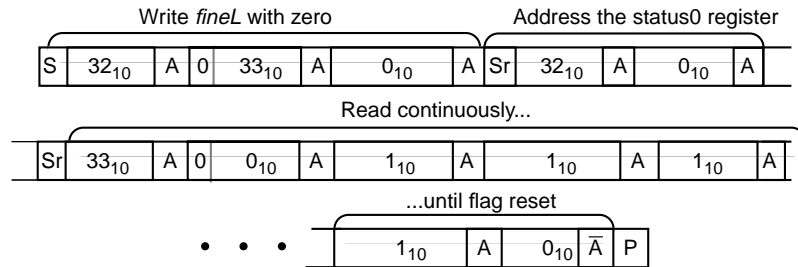

Figure 42 : Same location multiple data read.

9.6.6 Multiple location write

If the automatic increment bit is set (msb of the index byte), then it is possible to write data bytes to consecutive adjacent internal registers, (i.e. 23,24,25,26 etc), without having to send explicit indexes prior to sending each data byte. An auto-increment write to the exposure registers with their default values is shown in the following example, where we write 17₁₀ to the pin_mapping register[21] and 193₁₀ to the data format register[22].

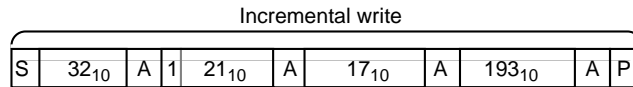

Figure 43 : Multiple location write.

9.6.7 Multiple location read

In the same manner, multiple locations can be read with a single read message. In this example the index is written first, to ensure the exposure related registers are addressed and then all six are read.

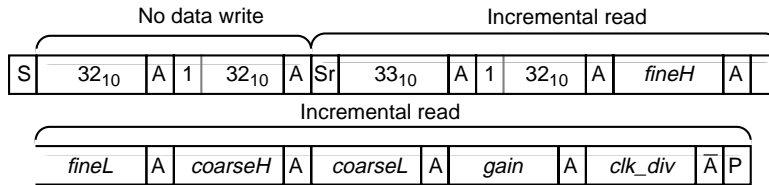

Figure 44 : Multiple location read.

Note: a stop condition is not required after the final negative acknowledge from the master, the sensor will terminate the communication upon receipt of the negative acknowledge from the master.

9.7 Serial Interface Timing

Parameter	Symbol	Min.	Max.	Unit
SCL clock frequency	f _{scl}	0	100	kHz
Bus free time between a stop and a start	t _{buf}	2	-	us
Hold time for a repeated start	t _{hd;sta}	80	-	ns
LOW period of SCL	t _{low}	320	-	ns
HIGH period of SCL	t _{high}	160	-	ns
Set-up time for a repeated start	t _{su;sta}	80	-	ns
Data hold time	t _{hd;dat}	0	-	ns
Data Set-up time	t _{su;dat}	0	-	ns
Rise time of SCL, SDA	t _r	-	300	ns
Fall time of SCL, SDA	t _f	-	300	ns
Set-up time for a stop	t _{su;sto}	80	-	ns
Capacitive load of each bus line (SCL, SDA)	C _b	-	200	pF

Table 58 : Serial Interface Timing Characteristics

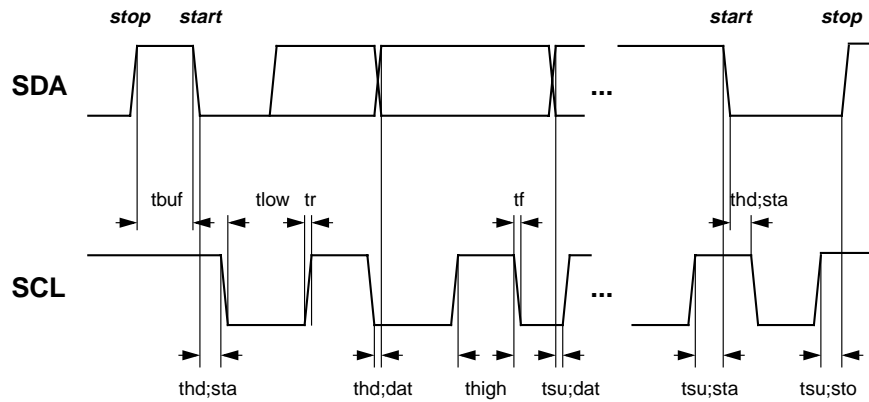

Figure 45 : Serial Interface Timing Characteristics

10. Clock Signal

VV5410/VV6410 system clock is supplied from an external clock source directly driving the CLKI pin. The clock pad has an integral Schmitt buffer to filter noise from the clock source. Please note that there is no support for an external resonator circuit.

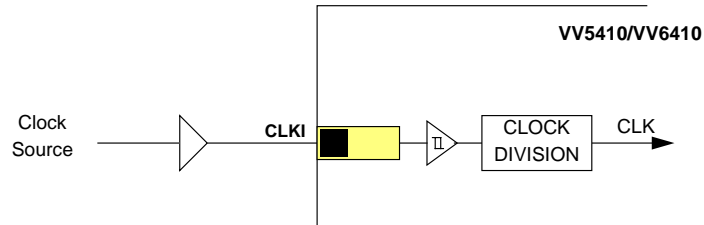

Figure 46 : CMOS Clock Source

The clock signal must be a square wave with, ideally a 50% (10%) mark:space ratio, although a non-ideal mark:space ratio can be tolerated, please contact STMicroelectronics for details. The maximum input clock frequency for the module is 24.0 MHz. If the 24MHz crystal is preferred then the user must select the pre-clock divide by 1.5 option such that the bulk of the internal logic is driven by a 16MHz clock, see serial interface, register 16₁₀, data_format.

11. Other Features

11.1 Audio Amplifier

VV5410/VV6410 contains an on-chip audio amplifier which can be configured via the serial interface. The amplifier may also be powered down via the serial interface.

The following document outlines the implementation of audio circuitry on the VV5410/VV6410 sensor.

11.1.1 Audio Amplifier Configuration

The audio circuit is controlled through a single eight bit register on the VV5410/VV6410. This includes bits for power down, output select, first and second stage gains and current boosting. Table 59 describes the functionality of the control register bits.

The first stage provides a gain of 0dB or 30dB using a low noise amplifier design.

The reference is provided from the on-chip bandgap voltage. This is buffered by a cut down version of the low-noise amplifier used in the first gain stage.

Bit	Function	Default	Comments
0	First stage gain	1	0 - 0dB 1 - 30dB
1	Second stage gain[1]	0	gain[1] gain[0] - gain(dB)
2	Second stage gain[0]	0	0 0 - 0dB 0 1 - 6dB 1 0 - 12dB 1 1 - 18dB
3	Power Down	0	0 - Powered up 1 - Power down
4	Output Select	0	0 - Single ended 1 - Differential
5	Current Boost	0	0 - 1mA output drive in output buffers 1 - 2mA output drive in output buffers
7:6	Unused		

Table 59 : Control register summary for VV5410/VV6410 audio circuit.

The output of the first gain stage is fed to two output amplifiers. These can be configured with a 1mA or 2mA output drive current. The inverting gain stage provides an additional gain between 0dB and 18dB.

The output of the inverting gain stage may be routed through the other output buffer to provide two single ended outputs. Otherwise, the inverted and non-inverted outputs provide a fully differential output signal.

Some more circuit specifications may be found in Table 60.

11.1.2 AUD3V3 (Audio Supply Regulator)

Symbol	Parameter	Min	Typical	Max	Units
AUD3V3	Regulated supply (No external load)	3.13	3.3	3.46	V
AUD3V3_Ld	Regulated supply Vdrop (Current Load 20mA)		-50		mV
AUD3V3_sus	Regulated supply (Suspend mode)		Off		V
ZAUD3V3_sus	Output impedance in Suspend mode		TBC		K Ω
PSRR	Power Supply Rejection versus Vin		-48		dB

Table 60 : Audio Circuit Specification

11.1.3 Audio Amplifier Parameters

Symbol	Parameter	Min	Typical	Max	Units
VAin	Audio Regulator Input Voltage		V _{bg}		V
R _{IN}	Input impedance		100		k Ω
Gain1	1st stage (28dB) gain accuracy		+/-0.5		dB
Gain2	2nd stage (0,6,12,18dB) gain accuracy ¹		+/-0.2		dB
Gmatch	Differential output mode gain matching (0dB) (28dB)		0.2 0.5		dB
Out_max	Output Clipping Level ²	1.6	2.2		V _{pp}
OUT_DC	Output DC Voltage	1.1	1.22	1.3	V
D-OUT_DC	Differential DC Offset (AoutN-AoutP)		20	100	mV
Rout	Output Impedance		2		k Ω
THD	THD (includes noise) Vin = 20mV _{pp} , f=1KHz, Gain =28dB		0.2		%
SNR	Signal to Noise ratio (1KHz) (10KHz) ³		65 75		dB
PSRR	Power supply rejection ratio from Vin		-55		dB
LFc	Low frequency cutoff (Cin=100nF)		15		Hz
Xtalk	Video crosstalk to audio outputs (gain = 28dB)		-56		dB

Table 61 : Audio Amplifier Parameters

1. 2nd stage gain is only available on AoutN with the audio amplifier in differential mode

2. Minimum dynamic range includes dc_{out} (i.e. $V_{clip} - OUT_DC$ is greater than $V_{ppmin}/2$)
3. Assumes 10 μ F bypass capacitors on all supplies and well separated supplies and grounds

11.1.4 Audio Amplifier Bandwidth¹

The audio circuit can be bandwidth limited to a first order, through the use of minimum external circuitry. The two outputs, AoutP and AoutN, require compensation capacitors that may also be used to define the bandwidth of the circuit.

Compensation Capacitor (nF)	3dB Bandwidth	Units
1	175	kHz
10	41	kHz
100	4.2	kHz

Table 62 : Compensation capacitor values

In addition, the inclusion of a resistor (microphone biasing) and decoupling capacitor at the input allows a first order high pass filter to be realised. This can easily be designed to remove frequencies below 50Hz/60Hz (mains electricity noise).

11.2 Voltage Regulators

VV5410/VV6410 contains three on-chip voltage regulators, two of which are capable of being powered-down via the serial interface. The third regulator, controlling the band gap references is never powered down. The band gap circuitry is extremely low power consuming only 30 μ A.

11.2.1 Regulator for Digital System

The output of the regulator, Reg3V3, powers the digital logic and can power an external co-processor. The regulator is powered up by default. The regulator has its own discrete power supply and can source a load of 300 μ A -> 150mA and will regulate to 3.0V 10% from an input range of 4-6V. When VV5410/VV6410 is in the USB compatible suspend mode, the clocks to the digital logic are removed to limit power consumption to approximately 80 μ A. If an external 3.3V supply is available, this regulator may be overdriven by an external 3.3V supply to directly power the logic. This voltage regulator is never powered down.

11.2.2 Regulator for Audio Amplifier

The output of the regulator for the audio amplifier, Aud3V3, drives the load resistor for the microphone and the audio pre-amplifier. As this regulator is capable of being powered-down via the serial interface, all control signals from the digital logic are low during low power/standby. This regulator will be powered up by default.

11.2.3 Regulator for Video Supply/Analogue Core

The output of the regulator for the video supply, Vid3V3, powers the analog core. This regulator is capable of being powered-down via the serial interface but will be powered up by default. Note that the sensor will be in low power mode initially and therefore

11.3 Valid Supply Voltage Configurations

The power supplies to the VV5410 and VV6410 sensors can be configured such that the sensor will operate in a number of systems:

- USB system (sensor will regulate the nominal 5V supply to 3V3 internally) with optional BJT to provide power for a companion chip.
- Direct drive the sensor with 3V3 (internal voltage regulators will be powered down in this mode).

The next 2 figures will detail the options described above:

1. Each audio output must have a capacitor (C_{comp}) connected to ground to avoid any oscillation

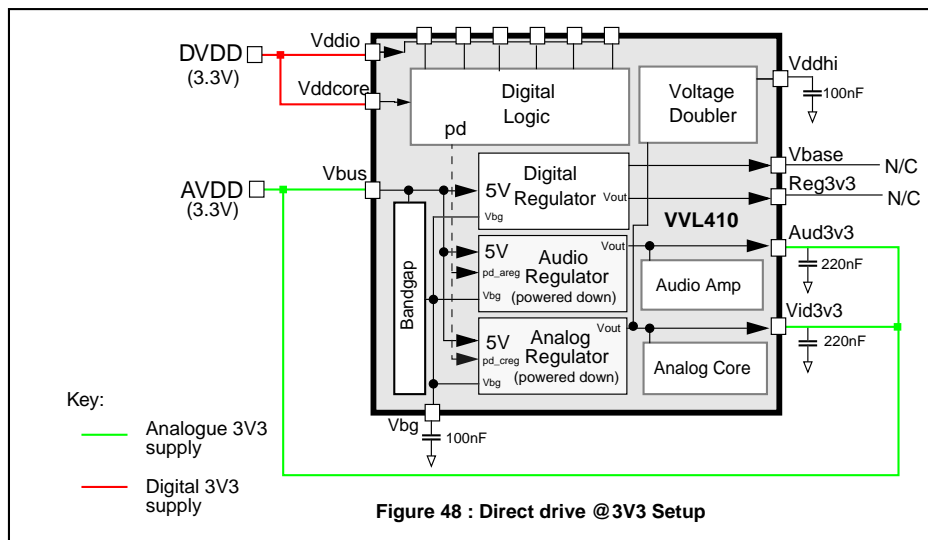
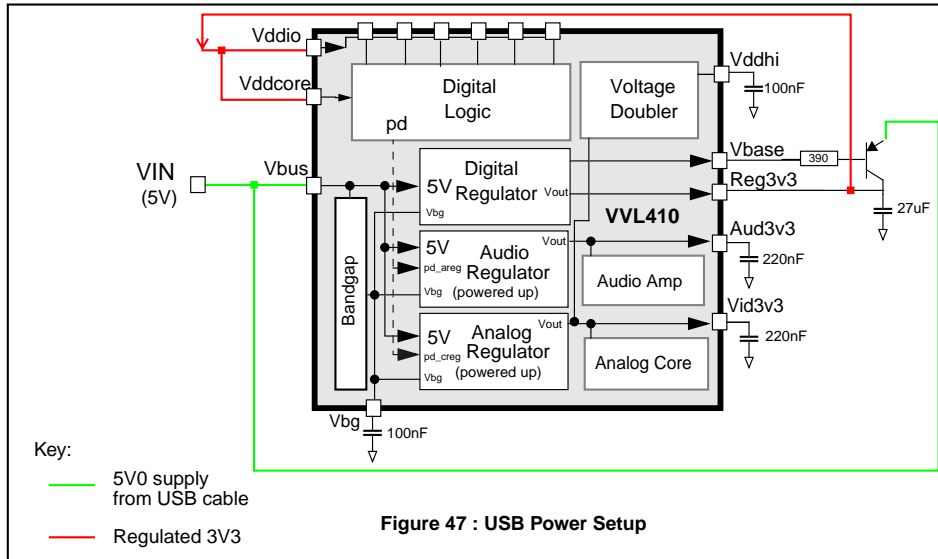

Supply	USB System	3.3V-only System
Vbus	Supply from USB cable	3.3V direct drive
Vddio	connect to Vreg3v3	3.3V direct drive
Vddcore	connect to Vreg3v3	3.3V direct drive
Vreg3v3	optionally populate external BJT for added drive	BJT not populated
Vid3v3	generated by internal regulator	internal regulator powered down
Aud3v3	generated by internal regulator	internal regulator powered down

Table 63 : Sensor Voltage Supply summary

11.4 Programmable Pins

The FST and QCK pins can be re-configured to follow the values of bits 1 and 2 in the serial interface register *pin_mapping*. This is to allow remote control of a electro-mechanical system, maybe two different crop settings, in a remote camera head via the serial interface.

12. Characterisation Details

12.1 VV5410/VV6410 AC/DC Specification

Parameter	Comment	Units
Image Format	356 x 292 pixels (PAL/CIF) 306 x 244 pixels (NTSC) 180 x 148 pixels (QCIF)	-
Pixel Size	7.5 x 6.9	µm
Technology	0.5µm 3 level metal CMOS	-
Array Format	CIF	-
Exposure control range	81 (minimum exposure period 3µs and maximum exposure period is 33ms)	db
Supply Voltage	3.0-6.0 DC +/-10%	V
Operating Temp. range	0 - 40	°C
$V_{OL_max}^2$	0.512	V
$V_{OH_min}^3$	2.054	V
$V_{L_maxL}^4$	0.683	V
$V_{IH_min}^5$	2.237	V
Serial interface frequency range	0-100kHz	

1. We assume CIF (30fps) mode, input clock of 16MHz and internal clock divisor of 1.
2. This is worst case reading. Device outputs had significant capacitive loading and supply voltage reduced to 2V7
3. This is worst case reading. Device outputs had significant capacitive loading and supply voltage reduced to 2V7
4. This is worst case reading. Device outputs had significant capacitive loading and supply voltage reduced to 2V7
5. This is worst case reading. Device outputs had significant capacitive loading and supply voltage reduced to 2V7

Table 64 : VV5410/6410 DC specification

12.2 VV5410/VV6410 Optical Characterisation Data

Optical Parameter	Min	Typical	Max	Units
Dark Current	-	46	-	mV/sec
Average Sensitivity	-	2.1	-	V/lux.sec
Fixed Pattern Noise (FPN)	-	1.74	-	mV
Vertical Fixed Pattern Noise (VFPN)	-	1.2	-	mV
Random Noise	-	1.17	-	mV
Sensor SNR	-	c.56	-	dB
Shading (Gross)	-	0.9	-	mV

Table 65 : VV5410/VV6410 Optical Characterisation Data

12.2.1 Noise Parameters and Dark Current

Various noise parameters are measured on the 410 device as follows:

- Fixed Pattern Noise (FPN)
- Vertical Fixed Pattern Noise (VFPN)
- Random Noise
- Fine Shading
- Gross Shading

The parameters will be described in more detail below along with the data produced by the characterisation programme.

12.2.2 Blooming

Blooming is a phenomenon that does not affect CMOS sensors in the same way as CCD imagers are afflicted. With a CCD blooming can cause an entire column/columns to flood and saturate.

CMOS imagers are however affected by a different type of saturation. If an intense light source, (e.g. Maglite torch), is shone at very close proximity to the image sensor the pixel sampling mechanism will break down and rather than displaying a saturated white light a black image will occur.

The 410 pixel architecture uses Correlated Double Sampling (CDS) to help reduce noise in the system. The pixel is read normally first, yielding the true integrated signal information, then the pixel is reset and very quickly read for a second time. This normally yields black information - as the pixel has had no exposure time - that can be subtracted from the signal from the first read. This subtraction will remove much of the noise from the pixel leaving only the useful signal information.

In an example where a pixel has saturated in both the first and the second reads due to an intense light source. When the noise cancellation subtraction operation is then performed the result is close to zero signal from the pixel therefore resulting in the displayed black image.

We do not perform any test measurements for this phenomenon.

12.2.3 Dark Current

This is defined as the rate at which the average pixel voltage increases over time with the device not illuminated. The dark current will be measured at a gain setting of 4 and a clock divisor of 16 at a fixed temperature and will be expressed in mV.

12.2.4 Fixed Pattern Noise

The FPN of an image sensor is the average pixel non-temporal noise divided by the average pixel voltage. The illumination source will be white light that has been IR filtered, producing a diffuse uniform illumination at the surface of the sensor package. The FPN will be calculated at coarse exposure settings of 0,10,150,250 and 302 with gain set to 1. 10 frames are grabbed and averaged to produce a temporally independent frame before each calculation. FPN will be expressed in mV.

12.2.5 Vertical Fixed Pattern Noise

VFPN describes the spatial noise in an image sensor related to patterns with a vertical orientation. The VFPN is defined as the standard deviation over all columns of the average pixel voltage for each column determined at zero exposure and zero illumination. VFPN will be expressed in mV.

12.2.6 Random Noise

Random noise is the temporal noise component within the image. Random noise will be expressed in mV.

12.2.7 Shading

This describes how average pixel values per "block" change across the image sensor array. For fine shading calculations the image sensor array is split into 30 pixel by 30 pixel blocks. An average value is then calculated for each block and the averages are then compared across the whole device. The blocks are increased in size to 60 pixels by 60 pixels for the gross shading calculation. Shading will be expressed in mV.

12.3 VV5410/VV6410 Power Consumption

Operating Condition	Current Consumption
Low power mode current consumption	5.6mA
Sleep mode current consumption ¹	18mA
Suspend mode current consumption (with CLKIP disabled)	85uA
Normal operating mode current consumption ²	26.2mA

1. Estimated figures - this parameter was not measured during final characterisation
2. Measured while device is clocked at 16MHz and streaming CIF video at 30fps

Table 66 : VV5410/6410 Current consumption in different modes

12.4 Digital Input Pad Pull-up and Pull-down Strengths

Pad Type	Pads	Min current	Max Current
Library pulldown	suspend	35uA	52uA
Library pullup	scl, sda, oeb	25uA	42uA
Custom pullup	resetb	66uA	250uA

Table 67 : Pad Pull-up/Pull-down Strengths

13. Pixel Defect Specification

13.1 Pixel Fault Definitions

Please find the pixel notation described in Figure 49 below. For the purposes of the test the 3x3 array describes 9 bayer pixels of a common colour, i.e. ALL the pixels will either be Red, Green or Blue. The pixel under test is X.

[0]	[1]	[2]
[7]	X	[3]
[6]	[5]	[4]

Figure 49 : Pixel Numbering Notation

13.2 Stuck at White Pixel Fault

A pixel is said to be "stuck at white" - it can also be referred to as "hot" - if it is saturated (pixel output at maximum) even with no incident light and exposure set to zero.

13.3 Stuck at Black Pixel Fault

A pixel is said to be "stuck at black" - it can also be referred to as "dead" - if the pixel output is zero even if the pixel is fully exposed to incident light.

13.4 Column / Row Faults

A line of continuous pixel fails of length > 3 will be described as a row fault in the x-direction and a column fault in the y-direction.

If the array contains more than 1 row or column fault and the defective pixels overlap as shown in Figure 50 then this fault is described as a double row or double column fault respectively. The minimum overlap is 1 pixel. A defective pixel is indicated by X and a good pixel by 'p'.

n	n+1
X	'p'
X	'p'
X	p
X	X
'p'	X
'p'	X
'p'	X

Figure 50 : Double Column Fault

In Figure 51 there are 2 column faults however there is no overlap between the 2 columns therefore there are 2 single column faults but no double column faults.

n	n+1
X	'p'
X	'p'
X	p
X	'p'
'p'	X
'p'	X
'p'	X
'p'	X

Figure 51 : Single Column Faults

13.5 Image Array Blemishes

The automatic test programme rejects any sensors that contain blemishes referred to as blobs and clusters (please see below for definitions of these terms) as they cannot be successfully defect corrected by ST coprocessor devices. Up to 120 single pixel faults can be corrected and sensors meeting this criteria will PASS this part of the test programme.

13.5.1 Cluster Definition

A failing pixel at X with a failing pixel at position [0] or [1] or [2] or [3] or [4] or [5] or [6] or [7] or any combination of these 8 positions except the case where all positions are defective. This is a special case and is described below. In the example in Figure 52 there are additional pixel fails in positions [3] and [7].

[0]	[1]	[2]
[X]	X	[X]
[6]	[5]	[4]

Figure 52 : Cluster Example

Blob (special case of cluster):- a failing pixel at position X with failing pixels at position [0],[1],[2],[3],[4],[5],[6] and [7] as in Figure 53 below:

[X]	[X]	[X]
[X]	X	[X]
[X]	[X]	[X]

Figure 53 : Blob Example

Single pixel:- a failing pixel with no immediate failing same colour neighbours. Pixels at position [0],[1],[2],[3],[4],[5],[6] and [7] are all valid pixels. Please see Figure 54 below.

[0]	[1]	[2]
[7]	X	[3]
[6]	[5]	[4]

Figure 54 : Isolated pixel fail

13.5.2 Summary Pass Criteria

Clusters	Blobs	Row Fails (inc doubles)	Column Fails (inc doubles)	Single pixel fails	Notes ¹
0	0	0	0	<=120	Pass

Table 68 : Sensor Pixel Defect Pass Criteria

1. If there is a non-zero number of clusters, blobs or row/column faults and greater than 120 single pixel defects then the device will be rejected and classed as a fail.

14. Pinout and pin descriptions

14.1 36pin CLCC Pinout Map

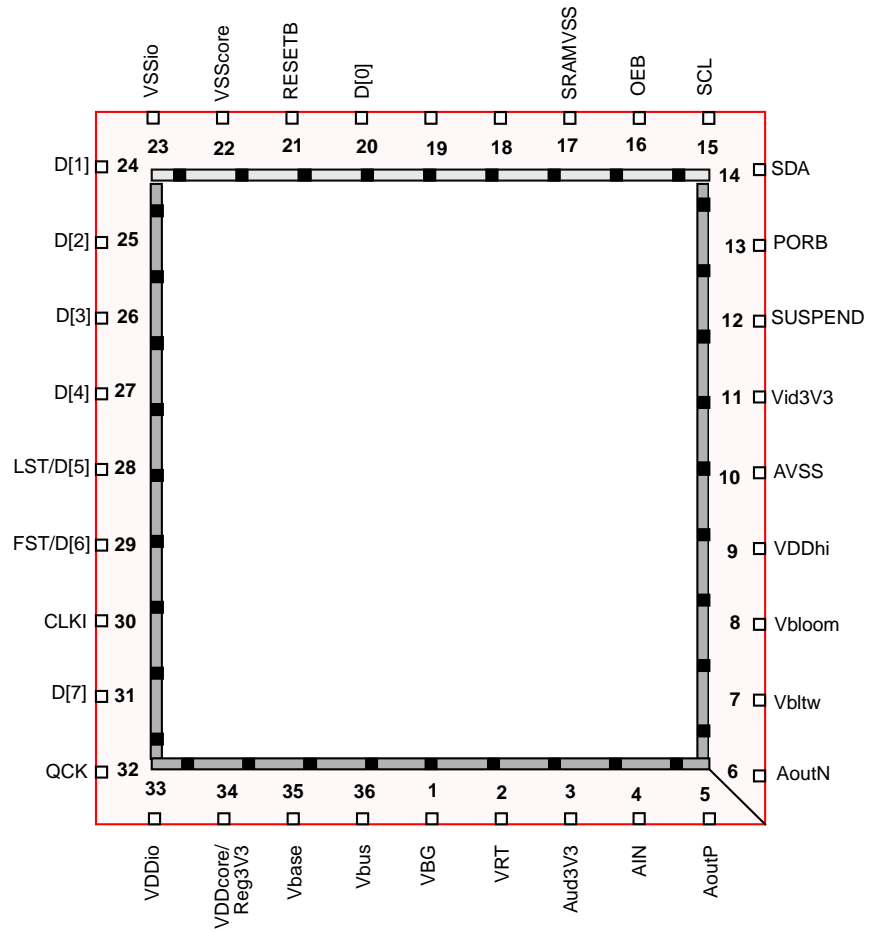

Figure 55 : 36 pin CLCC package pin assignment

Name	Pin Number	Type	Description
POWER SUPPLIES			
AVSS	10	GND	Core analog ground and reference supplies.

Name	Pin Number	Type	Description
SRAMVSS	17	GND	In-column SRAM analog ground.
VDDcore/ Reg3V3	34	PWR	Digital logic power.
VDDio	33	PWR	Digital pad ring power.
VSScore	22	GND	Digital logic ground.
VSSio	23	GND	Digital pad ring ground.
Vid3V3	11	PWR	On-chip Video Supply Voltage Regulator Output
Aud3V3	3	PWR	On-chip Audio Amplifier Voltage Regulator Output
ANALOG SIGNALS			
VBG	1	OA	Internally generated bandgap reference voltage 1.22V
VDDHI	9	IA	Voltage doubler output, 4.6V -> 4.8V
VBase	35	OA	Drive for base of external bipolar
Vbus	36	IA	Incoming power supply 3.3 -> 6V
AIN	4	IA	Analog input to Audio Amplifier
AOutP	5	OA	Analog output of Audio Amplifier (positive)
AOutN	6	OA	Analog output of Audio Amplifier (negative)
PORB	13	OD	Power-on Reset (Bar) Output.
DIGITAL VIDEO INTERFACE			
D[4]	27	ODT	Tri-stateable 5-wire output data bus. - D[4] is the most significant bit. - D[4:0] have programmable drive strengths 2, 4 and 6 mA
D[3]	26		
D[2]	25		
D[1]	24		
D[0]	20		
QCK	32	ODT	Tri-stateable data qualification clock.
LST/D[5]	28	ODT	Tri-stateable Line start output May be configured as tri-stateable output data bit 5 D[5].
FST/D[6]	29	ODT	Tri-stateable Frame start signal. May be configured as tri-stateable output data bit 6 D[6].
D[7]	31	ODT	Tri-stateable Data wire (ms data bit). May be configured as tri-stateable output data bit 6 D[6].
OEB	16	ID↓	Digital output (tri-state) enable.
DIGITAL CONTROL SIGNALS			

Name	Pin Number	Type	Description
RESETB	21	ID↑	System Reset. Active Low. May be configured as System Sync. Active Low.
SUSPEND	12	ID↑	USB Suspend Mode Control signal. Active High If this feature is not required then the support circuit must pull the pin to ground. The combination of an active high signal and pull up pad was chosen to limit current drawn by the device while in suspend mode.
SERIAL INTERFACE			
SCL	15	BI↑	Serial bus clock (input only).
SDA	14	BI↑	Serial bus data (bidirectional, open drain).
SYSTEM CLOCKS			
CLKI	30	ID↓	Schmitt Buffered Clock input or LVDS positive Clock input

Key			
A	Analog Input	D	Digital Input
OA	Analog Output	ID↑	Digital input with internal pull-up
BI	Bidirectional	ID↓	Digital input with internal pull-down
BI↑	Bidirectional with internal pull-up	OD	Digital Output
BI↓	Bidirectional with internal pull-down	ODT	Tri-stateable Digital Output

Name	Pin	Type	Description
ANALOG SIGNALS			
Vbloom	8	OA	Anti-blooming pixel reset voltage ¹
VBLTW	7	OA	Bitline test white level reference ²
VRT	2	IA	Pixel reset voltage ³

1. This pin has been removed from the production bonding diagram
2. This pin has been removed from the production bonding diagram
3. This pin has been removed from the production bonding diagram

15. Package Details (36pin CLCC)

RevNo	Revision note	ECN No.	Date
A	Pin Locations changed, tolerance added to Oall dims	14/7/99	2/8/99
B	Pin 103 tolerance revised	20/7/99	
C	1.03 +0.13 was 1.03 ± 0.08	15/10/99	2/8/99
D	1.16 dim tolerance revised		

Notes:

- Die is optically centred.
- Die area of sensor is -1.52
- Distance to optical surface of die.
- Pixel area of sensor.

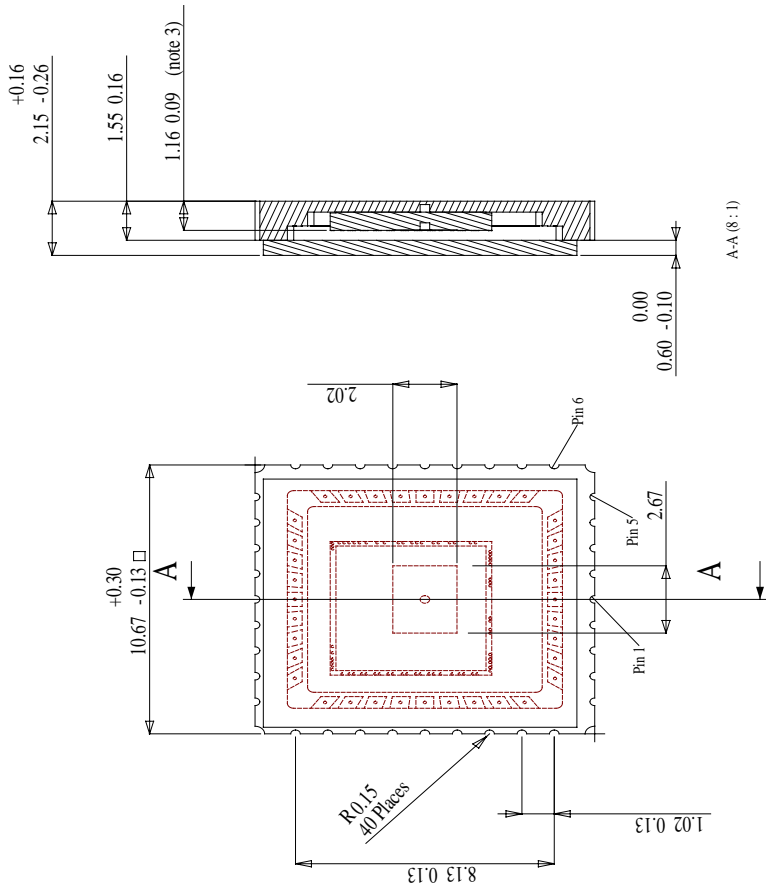
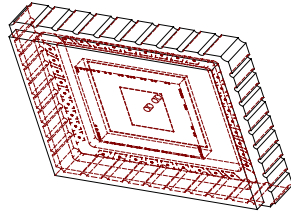

16. Recommended VV5410/6410 support circuit

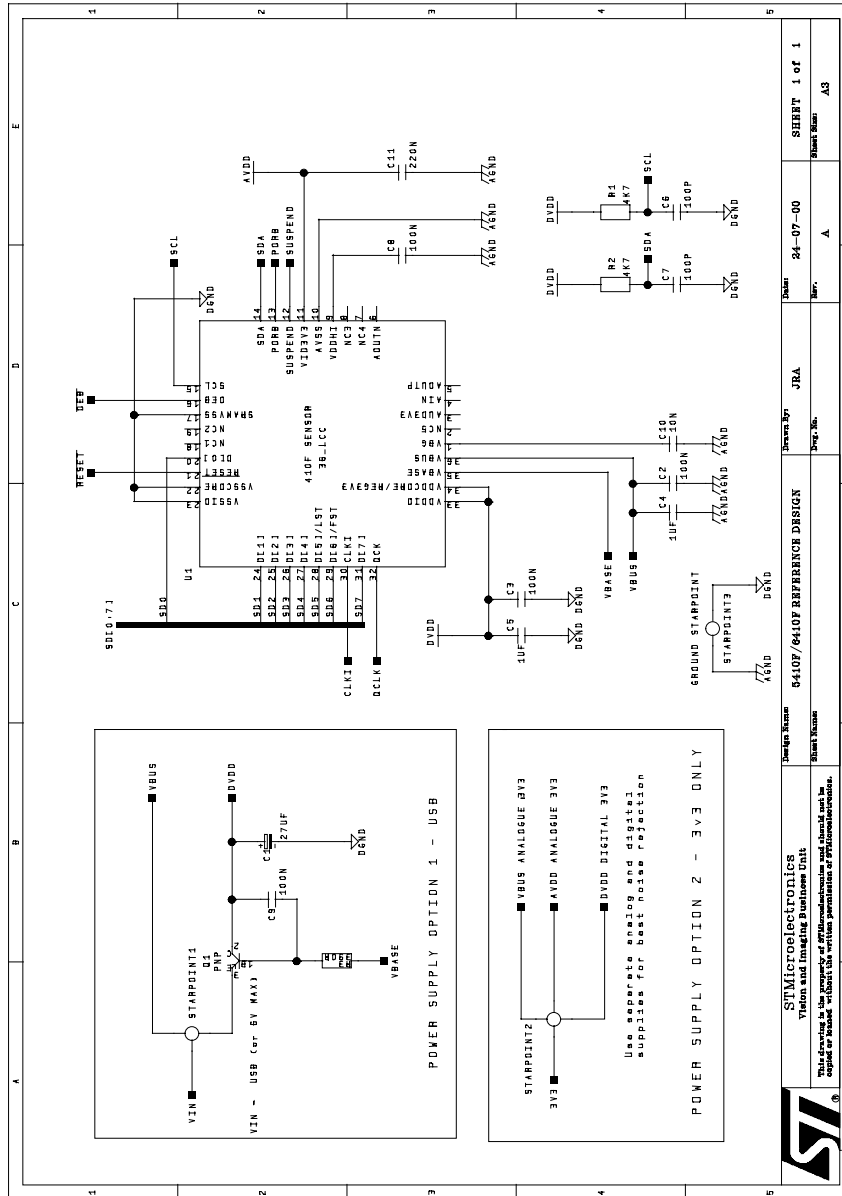

17. Evaluation kits (EVK's)

It is highly recommended that an Evaluation Kit (EVK) is used for initial evaluation and design-in of the VV5410/6410. A VV5410/VV6410 evaluation kit can now be ordered. Please contact STMicroelectronics for details.

18. Ordering details

Part Number	Description
VV5410C036	36pin CLCC packaged, microlensed CIF monochrome sensor
VV6410C036	36pin CLCC packaged, microlensed CIF ColourMOS sensor
STV0657	YUV/RGB CoProcessor
STV0672	USB companion CoProcessor
STV0680B-001	Digital stills companion CoProcessor
STV-5410-R01	Reference design board for VV6410C036
STV-6410-R01	Reference design board for VV6410C036
STV-USB/CIF-R01	Reference design board for VV6410C036 & STV0672
STV-YUV/CIF-R02	Reference design board for VV6410C036 & STV0657-001
STV-DCA/CIF-R01	Reference design board for VV6410C036 & STV0680B-001
STV-5410/5500-E01	Sensor only evaluation kit for VV6410C036 & VV6500-C048
STV-6410/6500-E01	Sensor only evaluation kit for VV6410C036 & VV6500-C048

Table 69 : VV6410/VV5410 Ordering Details

Information furnished is believed to be accurate and reliable. However, STMicroelectronics assumes no responsibility for the consequences of use of such information nor for any infringement of patents or other rights of third parties which may result from its use. No license is granted by implication or otherwise under any patent or patent rights of STMicroelectronics. Specifications mentioned in this publication are subject to change without notice. This publication supersedes and replaces all information previously supplied. STMicroelectronics products are not authorized for use as critical components in life support devices or systems without express written approval of STMicroelectronics

The ST logo is a registered trademark of STMicroelectronics

© 2000 STMicroelectronics - All Rights Reserved

Imaging Division

www.st.com

asiapacific.imaging@st.com
centraleurope.imaging@st.com
france.imaging@st.com
japan.imaging@st.com
nordic.imaging@st.com
southern europe.imaging@st.com
ukeire.imaging@st.com
usa.imaging@st.com

