

LH28F008SCT-L12

Flash Memory

8M (1M × 8)

(Model No.: LHF08CH3)

Spec No.: EL104164B

Issue Date: May 7, 1999

- Handle this document carefully for it contains material protected by international copyright law. Any reproduction, full or in part, of this material is prohibited without the express written permission of the company.
- When using the products covered herein, please observe the conditions written herein and the precautions outlined in the following paragraphs. In no event shall the company be liable for any damages resulting from failure to strictly adhere to these conditions and precautions.
 - (1) The products covered herein are designed and manufactured for the following application areas. When using the products covered herein for the equipment listed in Paragraph (2), even for the following application areas, be sure to observe the precautions given in Paragraph (2). Never use the products for the equipment listed in Paragraph (3).
 - Office electronics
 - Instrumentation and measuring equipment
 - Machine tools
 - Audiovisual equipment
 - Home appliance
 - Communication equipment other than for trunk lines
 - (2) Those contemplating using the products covered herein for the following equipment which demands high reliability, should first contact a sales representative of the company and then accept responsibility for incorporating into the design fail-safe operation, redundancy, and other appropriate measures for ensuring reliability and safety of the equipment and the overall system.
 - Control and safety devices for airplanes, trains, automobiles, and other transportation equipment
 - Mainframe computers
 - Traffic control systems
 - Gas leak detectors and automatic cutoff devices
 - Rescue and security equipment
 - Other safety devices and safety equipment, etc.
 - (3) Do not use the products covered herein for the following equipment which demands extremely high performance in terms of functionality, reliability, or accuracy.
 - Aerospace equipment
 - Communications equipment for trunk lines
 - Control equipment for the nuclear power industry
 - Medical equipment related to life support, etc.
 - (4) Please direct all queries and comments regarding the interpretation of the above three Paragraphs to a sales representative of the company.
- Please direct all queries regarding the products covered herein to a sales representative of the company.

CONTENTS

	PAGE		PAGE
1.0 INTRODUCTION	3	5.0 DESIGN CONSIDERATIONS	23
1.1 New Features	3	5.1 Three-Line Output Control	23
1.2 Product Overview	3	5.2 RY/BY# and Block Erase, Byte Write and Lock-Bit Configuration Polling	23
2.0 PRINCIPLES OF OPERATION	7	5.3 Power Supply Decoupling	23
2.1 Data Protection	7	5.4 V _{PP} Trace on Printed Circuit Boards	23
3.0 BUS OPERATION	8	5.5 V _{CC} , V _{PP} , RP# Transitions	24
3.1 Read	8	5.6 Power-Up/Down Protection	24
3.2 Output Disable	8	5.7 Power Dissipation	24
3.3 Standby	8	6.0 ELECTRICAL SPECIFICATIONS	25
3.4 Deep Power-Down	8	6.1 Absolute Maximum Ratings	25
3.5 Read Identifier Codes Operation	9	6.2 Operating Conditions	25
3.6 Write	9	6.2.1 Capacitance	25
4.0 COMMAND DEFINITIONS	9	6.2.2 AC Input/Output Test Conditions	26
4.1 Read Array Command	12	6.2.3 DC Characteristics	27
4.2 Read Identifier Codes Command	12	6.2.4 AC Characteristics - Read-Only Operations	29
4.3 Read Status Register Command	12	6.2.5 AC Characteristics - Write Operations	32
4.4 Clear Status Register Command	12	6.2.6 Alternative CE#-Controlled Writes	35
4.5 Block Erase Command	12	6.2.7 Reset Operations	38
4.6 Byte Write Command	13	6.2.8 Block Erase, Byte Write and Lock-Bit Configuration Performance	39
4.7 Block Erase Suspend Command	13	7.0 ADDITIONAL INFORMATION	40
4.8 Byte Write Suspend Command	14	7.1 Ordering Information	40
4.9 Set Block and Master Lock-Bit Commands	14	8.0 PACKAGE AND PACKING SPECIFICATIONS ..	41
4.10 Clear Block Lock-Bits Command	15		

LH28F008SCT-L12 8M-BIT (1MB x 8) SmartVoltage Flash MEMORY

- **SmartVoltage Technology**
 - 2.7V(Read-Only), 3.3V or 5V V_{CC}
 - 3.3V, 5V or 12V V_{PP}
- **High-Performance Read Access Time**
 - 120ns(5V \pm 0.5V), 150ns(3.3V \pm 0.3V), 170ns(2.7V-3.6V)
- **Operating Temperature**
 - 0°C to +70°C
- **High-Density Symmetrically-Blocked Architecture**
 - Sixteen 64K-byte Erasable Blocks
- **Low Power Management**
 - Deep Power-Down Mode
 - Automatic Power Savings Mode Decreases I_{CC} in Static Mode
- **Enhanced Data Protection Features**
 - Absolute Protection with $V_{PP}=GND$
 - Flexible Block Locking
 - Block Erase/Byte Write Lockout during Power Transitions
- **Automated Byte Write and Block Erase**
 - Command User Interface
 - Status Register
- **Enhanced Automated Suspend Options**
 - Byte Write Suspend to Read
 - Block Erase Suspend to Byte Write
 - Block Erase Suspend to Read
- **Extended Cycling Capability**
 - 100,000 Block Erase Cycles
 - 1.6 Million Block Erase Cycles/Chip
- **SRAM-Compatible Write Interface**
- **Industry-Standard Packaging**
 - 40-Lead TSOP
- **ETOX™* Nonvolatile Flash Technology**
- **CMOS Process**
(P-type silicon substrate)
- **Not designed or rated as radiation hardened**

SHARP's LH28F008SCT-L12 Flash memory with SmartVoltage technology is a high-density, low-cost, nonvolatile, read/write storage solution for a wide range of applications. Its symmetrically-blocked architecture, flexible voltage and extended cycling provide for highly flexible component suitable for resident flash arrays, SIMMs and memory cards. Its enhanced suspend capabilities provide for an ideal solution for code + data storage applications. For secure code storage applications, such as networking, where code is either directly executed out of flash or downloaded to DRAM, the LH28F008SCT-L12 offers three levels of protection: absolute protection with V_{PP} at GND, selective hardware block locking, or flexible software block locking. These alternatives give designers ultimate control of their code security needs.

The LH28F008SCT-L12 is manufactured on SHARP's 0.38 μ m ETOX™ process technology. It come in industry-standard package: the 40-lead TSOP, ideal for board constrained applications. Based on the 28F008SA architecture, the LH28F008SCT-L12 enables quick and easy upgrades for designs demanding the state-of-the-art.

*ETOX is a trademark of Intel Corporation.

1 INTRODUCTION

This datasheet contains LH28F008SCT-L12 specifications. Section 1 provides a flash memory overview. Sections 2, 3, 4, and 5 describe the memory organization and functionality. Section 6 covers electrical specifications. LH28F008SCT-L12 Flash memory documentation also includes application notes and design tools which are referenced in Section 7.

1.1 New Features

The LH28F008SCT-L12 SmartVoltage Flash memory maintains backwards-compatibility with SHARP's 28F008SA. Key enhancements over the 28F008SA include:

- SmartVoltage Technology
- Enhanced Suspend Capabilities
- In-System Block Locking

Both devices share a compatible pinout, status register, and software command set. These similarities enable a clean upgrade from the 28F008SA to LH28F008SCT-L12. When upgrading, it is important to note the following differences:

- Because of new feature support, the two devices have different device codes. This allows for software optimization.
- V_{PPLK} has been lowered from 6.5V to 1.5V to support 3.3V and 5V block erase, byte write, and lock-bit configuration operations. The V_{PP} voltage transitions to GND is recommended for designs that switch V_{PP} off during read operation.
- To take advantage of SmartVoltage technology, allow V_{PP} connection to 3.3V or 5V.

1.2 Product Overview

The LH28F008SCT-L12 is a high-performance 8M-bit SmartVoltage Flash memory organized as 1M-byte of 8 bits. The 1M-byte of data is arranged in sixteen 64K-byte blocks which are individually erasable, lockable, and unlockable in-system. The memory map is shown in Figure 3.

SmartVoltage technology provides a choice of V_{CC} and V_{PP} combinations, as shown in Table 1, to meet system performance and power expectations. 2.7V V_{CC} consumes approximately one-fifth the power of 5V V_{CC} . But, 5V V_{CC} provides the highest read performance. V_{PP} at 3.3V and 5V eliminates the need for a separate 12V converter, while $V_{PP}=12V$ maximizes block erase and byte write performance. In addition to flexible erase and program voltages, the dedicated V_{PP} pin gives complete data protection when $V_{PP} \leq V_{PPLK}$.

Table 1. V_{CC} and V_{PP} Voltage Combinations Offered by SmartVoltage Technology

V_{CC} Voltage	V_{PP} Voltage
2.7V ⁽¹⁾	—
3.3V	3.3V, 5V, 12V
5V	5V, 12V

NOTE:

1. Block erase, byte write and lock-bit configuration operations with $V_{CC} < 3.0V$ are not supported.

Internal V_{CC} and V_{PP} detection Circuitry automatically configures the device for optimized read and write operations.

A Command User Interface (CUI) serves as the interface between the system processor and internal operation of the device. A valid command sequence written to the CUI initiates device automation. An internal Write State Machine (WSM) automatically executes the algorithms and timings necessary for block erase, byte write, and lock-bit configuration operations.

A block erase operation erases one of the device's 64K-byte blocks typically within 0.3s (5V V_{CC} , 12V V_{PP}) independent of other blocks. Each block can be independently erased 100,000 times (1.6 million block erases per device). Block erase suspend mode allows system software to suspend block erase to read or write data from any other block.

Writing memory data is performed in byte increments typically within 6 μ s (5V V_{CC} , 12V V_{PP}). Byte write suspend mode enables the system to read data or execute code from any other flash memory array location.

Individual block locking uses a combination of bits, sixteen block lock-bits and a master lock-bit, to lock and unlock blocks. Block lock-bits gate block erase and byte write operations, while the master lock-bit gates block lock-bit modification. Lock-bit configuration operations (Set Block Lock-Bit, Set Master Lock-Bit, and Clear Block Lock-Bits commands) set and cleared lock-bits.

The status register indicates when the WSM's block erase, byte write, or lock-bit configuration operation is finished.

The RY/BY# output gives an additional indicator of WSM activity by providing both a hardware signal of status (versus software polling) and status masking (interrupt masking for background block erase, for example). Status polling using RY/BY# minimizes both CPU overhead and system power consumption. When low, RY/BY# indicates that the WSM is performing a block erase, byte write, or lock-bit configuration. RY/BY#-high indicates that the WSM is ready for a new command, block erase is suspended (and byte write is inactive), byte write is suspended, or the device is in deep power-down mode.

The access time is 120 ns (t_{AVQV}) over the commercial temperature range (0°C to +70°C) and V_{CC} supply voltage range of 4.5V-5.5V. At lower V_{CC} voltages, the access times are 150 ns (3.0V-3.6V) and 170 ns (2.7V-3.6V).

The Automatic Power Savings (APS) feature substantially reduces active current when the device is in static mode (addresses not switching). In APS mode, the typical I_{CCR} current is 1 mA at 5V V_{CC} .

When CE# and RP# pins are at V_{CC} , the I_{CC} CMOS standby mode is enabled. When the RP# pin is at GND, deep power-down mode is enabled which minimizes power consumption and provides write protection during reset. A reset time (t_{PHQV}) is required from RP# switching high until outputs are valid. Likewise, the device has a wake time (t_{PHEL}) from RP#-high until writes to the CUI are recognized. With RP# at GND, the WSM is reset and the status register is cleared.

The device is available in 40-lead TSOP (Thin Small Outline Package, 1.2 mm thick). Pinout is shown in Figure 2.

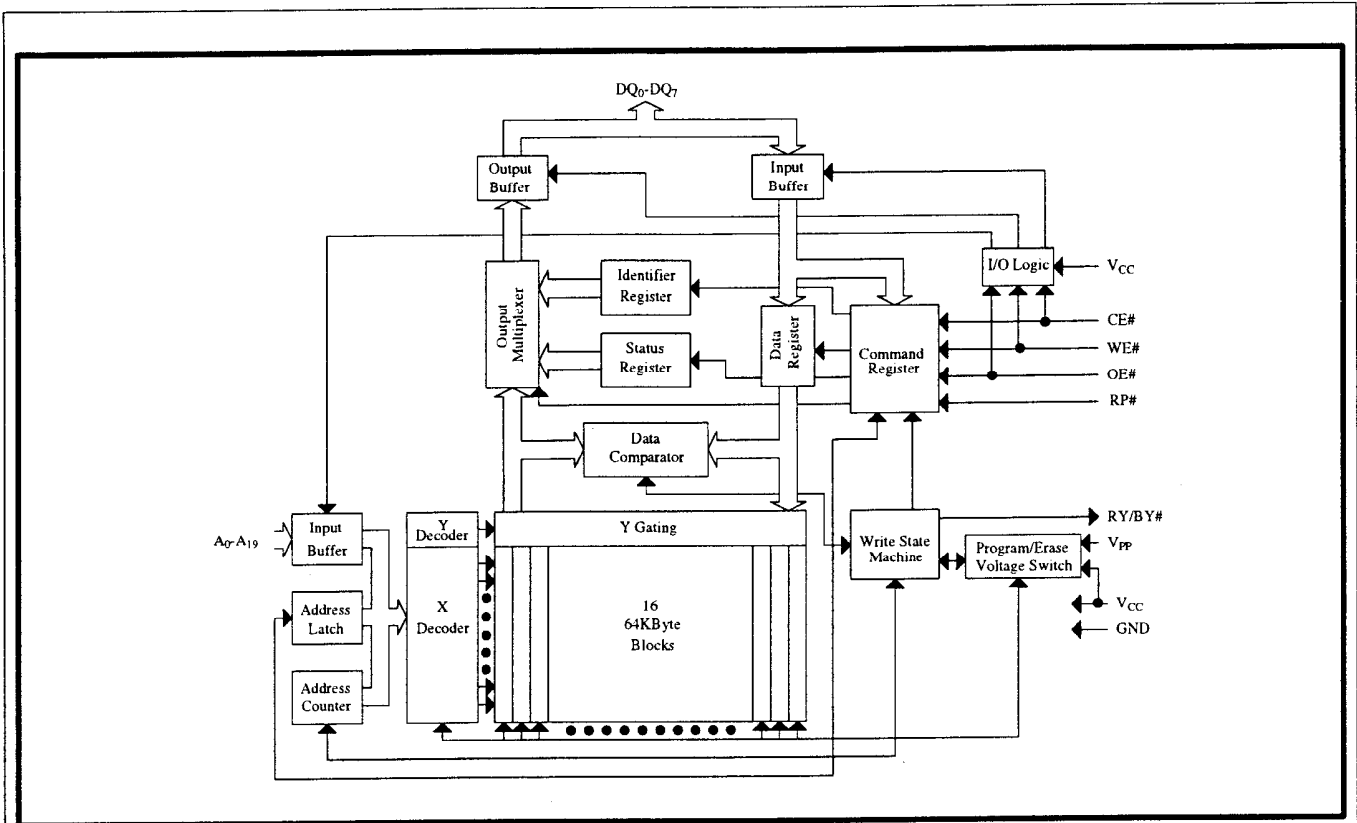

Figure 1. Block Diagram

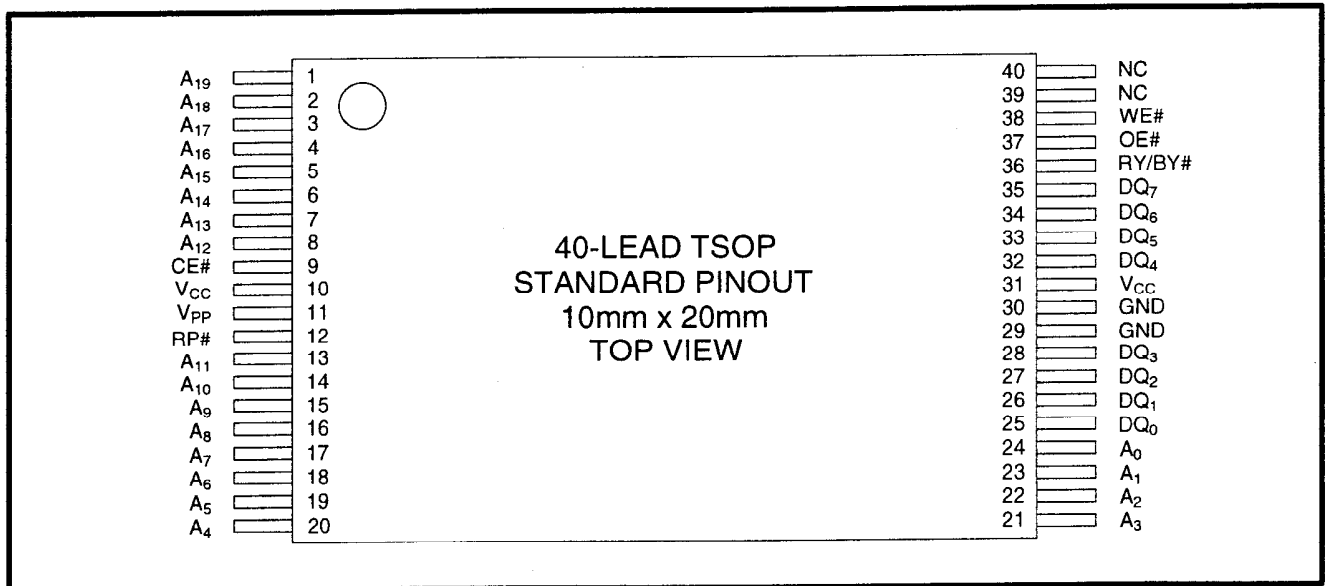

Figure 2. TSOP 40-Lead Pinout

Table 2. Pin Descriptions

Symbol	Type	Name and Function
A ₀ -A ₁₉	INPUT	ADDRESS INPUTS: Inputs for addresses during read and write operations. Addresses are internally latched during a write cycle.
DQ ₀ -DQ ₇	INPUT/ OUTPUT	DATA INPUT/OUTPUTS: Inputs data and commands during CUI write cycles; outputs data during memory array, status register, and identifier code read cycles. Data pins float to high-impedance when the chip is deselected or outputs are disabled. Data is internally latched during a write cycle.
CE#	INPUT	CHIP ENABLE: Activates the device's control logic, input buffers, decoders, and sense amplifiers. CE#-high deselects the device and reduces power consumption to standby levels.
RP#	INPUT	RESET/DEEP POWER-DOWN: Puts the device in deep power-down mode and resets internal automation. RP#-high enables normal operation. When driven low, RP# inhibits write operations which provides data protection during power transitions. Exit from deep power-down sets the device to read array mode. RP# at V _{HH} enables setting of the master lock-bit and enables configuration of block lock-bits when the master lock-bit is set. RP#=V _{HH} overrides block lock-bits thereby enabling block erase and byte write operations to locked memory blocks. Block erase, byte write, or lock-bit configuration with V _{IH} <RP#<V _{HH} produce spurious results and should not be attempted.
OE#	INPUT	OUTPUT ENABLE: Gates the device's outputs during a read cycle.
WE#	INPUT	WRITE ENABLE: Controls writes to the CUI and array blocks. Addresses and data are latched on the rising edge of the WE# pulse.
RY/BY#	OUTPUT	READY/BUSY#: Indicates the status of the internal WSM. When low, the WSM is performing an internal operation (block erase, byte write, or lock-bit configuration). RY/BY#-high indicates that the WSM is ready for new commands, block erase is suspended, and byte write is inactive, byte write is suspended, or the device is in deep power-down mode. RY/BY# is always active and does not float when the chip is deselected or data outputs are disabled.
V _{PP}	SUPPLY	BLOCK ERASE, BYTE WRITE, LOCK-BIT CONFIGURATION POWER SUPPLY: For erasing array blocks, writing bytes, or configuring lock-bits. With V _{PP} ≤V _{PPLK} , memory contents cannot be altered. Block erase, byte write, and lock-bit configuration with an invalid V _{PP} (see DC Characteristics) produce spurious results and should not be attempted.
V _{CC}	SUPPLY	DEVICE POWER SUPPLY: Internal detection configures the device for 2.7V, 3.3V or 5V operation. To switch from one voltage to another, ramp V _{CC} down to GND and then ramp V _{CC} to the new voltage. Do not float any power pins. With V _{CC} ≤V _{LKO} , all write attempts to the flash memory are inhibited. Device operations at invalid V _{CC} voltage (see DC Characteristics) produce spurious results and should not be attempted. Block erase, byte write and lock-bit configuration operations with V _{CC} <3.0V are not supported.
GND	SUPPLY	GROUND: Do not float any ground pins.
NC		NO CONNECT: Lead is not internal connected; it may be driven or floated.

2 PRINCIPLES OF OPERATION

The LH28F008SCT-L12 SmartVoltage Flash memory includes an on-chip WSM to manage block erase, byte write, and lock-bit configuration functions. It allows for: 100% TTL-level control inputs, fixed power supplies during block erasure, byte write, and lock-bit configuration, and minimal processor overhead with RAM-Like interface timings.

After initial device power-up or return from deep power-down mode (see Bus Operations), the device defaults to read array mode. Manipulation of external memory control pins allow array read, standby, and output disable operations.

Status register and identifier codes can be accessed through the CUI independent of the V_{PP} voltage. High voltage on V_{PP} enables successful block erasure, byte writing, and lock-bit configuration. All functions associated with altering memory contents—block erase, byte write, Lock-bit configuration, status, and identifier codes—are accessed via the CUI and verified through the status register.

Commands are written using standard microprocessor write timings. The CUI contents serve as input to the WSM, which controls the block erase, byte write, and lock-bit configuration. The internal algorithms are regulated by the WSM, including pulse repetition, internal verification, and margining of data. Addresses and data are internally latch during write cycles. Writing the appropriate command outputs array data, accesses the identifier codes, or outputs status register data.

Interface software that initiates and polls progress of block erase, byte write, and lock-bit configuration can be stored in any block. This code is copied to and executed from system RAM during flash memory updates. After successful completion, reads are again possible via the Read Array command. Block erase suspend allows system software to suspend a block erase to read or write data from any other block. Byte write suspend allows system software to suspend a byte write to read data from any other flash memory array location.

FFFF	64K-byte Block	15
F000		
EFFF	64K-byte Block	14
E000		
DFFF	64K-byte Block	13
D000		
CFFF	64K-byte Block	12
C000		
BFFF	64K-byte Block	11
B000		
AFFF	64K-byte Block	10
A000		
9FFF	64K-byte Block	9
9000		
8FFF	64K-byte Block	8
8000		
7FFF	64K-byte Block	7
7000		
6FFF	64K-byte Block	6
6000		
5FFF	64K-byte Block	5
5000		
4FFF	64K-byte Block	4
4000		
3FFF	64K-byte Block	3
3000		
2FFF	64K-byte Block	2
2000		
1FFF	64K-byte Block	1
1000		
0FFF	64K-byte Block	0
0000		

Figure 3. Memory Map

2.1 Data Protection

Depending on the application, the system designer may choose to make the V_{PP} power supply switchable (available only when memory block erases, byte writes, or lock-bit configurations are required) or hardwired to $V_{PPH1/2/3}$. The device accommodates either design practice and encourages optimization of the processor-memory interface.

When $V_{PP} \leq V_{PPLK}$, memory contents cannot be altered. The CUI, with two-step block erase, byte write, or lock-bit configuration command sequences, provides protection from unwanted operations even when high voltage is applied to V_{PP} . All write functions are disabled when V_{CC} is below the write lockout voltage V_{LKO} or when $RP\#$ is at V_{IL} . The device's block locking capability provides additional protection from inadvertent code or data alteration by gating erase and byte write operations.

3 BUS OPERATION

The local CPU reads and writes flash memory in-system. All bus cycles to or from the flash memory conform to standard microprocessor bus cycles.

3.1 Read

Information can be read from any block, identifier codes, or status register independent of the V_{PP} voltage. $RP\#$ can be at either V_{IH} or V_{HH} .

The first task is to write the appropriate read mode command (Read Array, Read Identifier Codes, or Read Status Register) to the CUI. Upon initial device power-up or after exit from deep power-down mode, the device automatically resets to read array mode. Four control pins dictate the data flow in and out of the component: $CE\#$, $OE\#$, $WE\#$, and $RP\#$. $CE\#$ and $OE\#$ must be driven active to obtain data at the outputs. $CE\#$ is the device selection control, and when active enables the selected memory device. $OE\#$ is the data output (DQ_0 - DQ_7) control and when active drives the selected memory data onto the I/O bus. $WE\#$ must be at V_{IH} and $RP\#$ must be at V_{IH} or V_{HH} . Figure 15 illustrates a read cycle.

3.2 Output Disable

With $OE\#$ at a logic-high level (V_{IH}), the device outputs are disabled. Output pins DQ_0 - DQ_7 are placed in a high-impedance state.

3.3 Standby

$CE\#$ at a logic-high level (V_{IH}) places the device in standby mode which substantially reduces device power consumption. DQ_0 - DQ_7 outputs are placed in a high-impedance state independent of $OE\#$. If deselected during block erase, byte write, or lock-bit configuration, the device continues functioning, and

consuming active power until the operation completes.

3.4 Deep Power-Down

$RP\#$ at V_{IL} initiates the deep power-down mode.

In read modes, $RP\#$ -low deselects the memory, places output drivers in a high-impedance state and turns off all internal circuits. $RP\#$ must be held low for a minimum of 100 ns. Time t_{PHQV} is required after return from power-down until initial memory access outputs are valid. After this wake-up interval, normal operation is restored. The CUI is reset to read array mode and status register is set to 80H.

During block erase, byte write, or lock-bit configuration modes, $RP\#$ -low will abort the operation. $RY/BY\#$ remains low until the reset operation is complete. Memory contents being altered are no longer valid; the data may be partially erased or written. Time t_{PHWL} is required after $RP\#$ goes to logic-high (V_{IH}) before another command can be written.

As with any automated device, it is important to assert $RP\#$ during system reset. When the system comes out of reset, it expects to read from the flash memory. Automated flash memories provide status information when accessed during block erase, byte write, or lock-bit configuration modes. If a CPU reset occurs with no flash memory reset, proper CPU initialization may not occur because the flash memory may be providing status information instead of array data. SHARP's flash memories allow proper CPU initialization following a system reset through the use of the $RP\#$ input. In this application, $RP\#$ is controlled by the same $RESET\#$ signal that resets the system CPU.

3.5 Read Identifier Codes Operation

The read identifier codes operation outputs the manufacturer code, device code, block lock configuration codes for each block, and the master lock configuration code (see Figure 4). Using the manufacturer and device codes, the system CPU can automatically match the device with its proper algorithms. The block lock and master lock configuration codes identify locked and unlocked blocks and master lock-bit setting.

3.6 Write

Writing commands to the CUI enable reading of device data and identifier codes. They also control inspection and clearing of the status register. When $V_{PP}=V_{PPH1/2/3}$, the CUI additionally controls block erasure, byte write, and lock-bit configuration.

The Block Erase command requires appropriate command data and an address within the block to be erased. The Byte Write command requires the command and address of the location to be written. Set Master and Block Lock-Bit commands require the command and address within the device (Master Lock) or block within the device (Block Lock) to be locked. The Clear Block Lock-Bits command requires the command and address within the device.

The CUI does not occupy an addressable memory location. It is written when WE# and CE# are active. The address and data needed to execute a command are latched on the rising edge of WE# or CE# (whichever goes high first). Standard microprocessor write timings are used. Figures 16 and 17 illustrate WE# and CE#-controlled write operations.

4 COMMAND DEFINITIONS

When the V_{PP} voltage $\leq V_{PPLK}$, Read operations from the status register, identifier codes, or blocks are enabled. Placing $V_{PPH1/2/3}$ on V_{PP} enables successful block erase, byte write and lock-bit configuration operations.

Device operations are selected by writing specific commands into the CUI. Table 4 defines these commands.

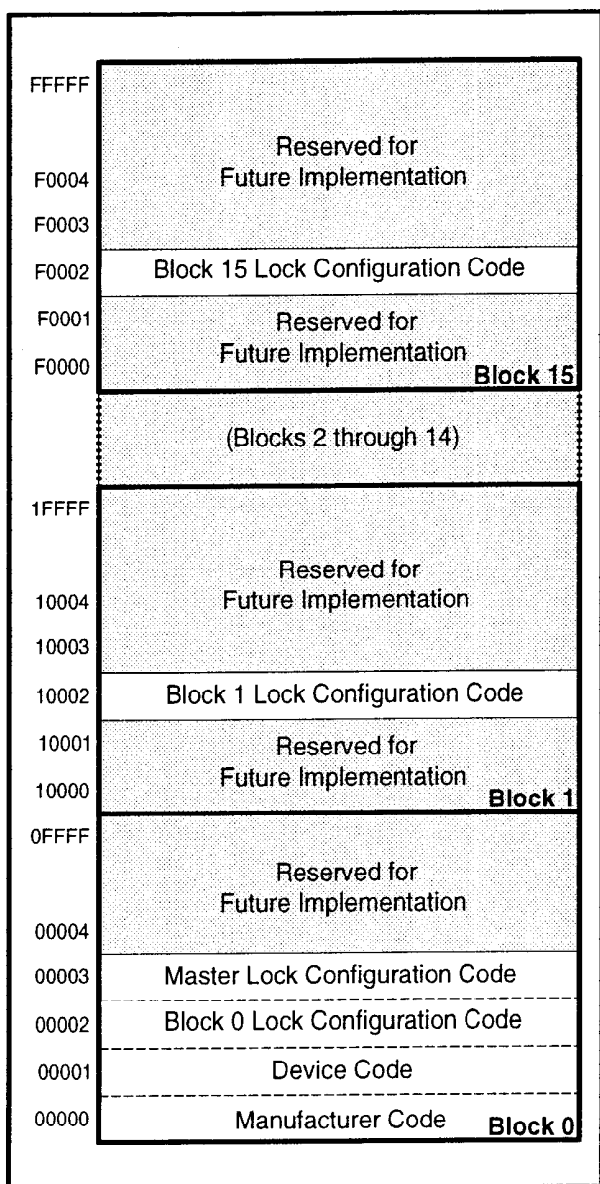

Figure 4. Device Identifier Code Memory Map

Table 3. Bus Operations

Mode	Notes	RP#	CE#	OE#	WE#	Address	V _{PP}	DQ ₀₋₇	RY/BY#
Read	1,2,3,8	V _{IH} or V _{HH}	V _{IL}	V _{IL}	V _{IH}	X	X	D _{OUT}	X
Output Disable	3	V _{IH} or V _{HH}	V _{IL}	V _{IH}	V _{IH}	X	X	High Z	X
Standby	3	V _{IH} or V _{HH}	V _{IH}	X	X	X	X	High Z	X
Deep Power-Down	4	V _{IL}	X	X	X	X	X	High Z	V _{OH}
Read Identifier Codes	8	V _{IH} or V _{HH}	V _{IL}	V _{IL}	V _{IH}	See Figure 4	X	Note 5	V _{OH}
Write	3,6,7,8	V _{IH} or V _{HH}	V _{IL}	V _{IH}	V _{IL}	X	X	D _{IN}	X

NOTES:

1. Refer to DC Characteristics. When $V_{PP} < V_{PPLK}$, memory contents can be read, but not altered.
2. X can be V_{IL} or V_{IH} for control pins and addresses, and V_{PPLK} or V_{PPH1/2/3} for V_{PP}. See DC Characteristics for V_{PPLK} and V_{PPH1/2/3} voltages.
3. RY/BY# is V_{OL} when the WSM is executing internal block erase, byte write, or lock-bit configuration algorithms. It is V_{OH} during when the WSM is not busy, in block erase suspend mode (with byte write inactive), byte write suspend mode, or deep power-down mode.
4. RP# at GND±0.2V ensures the lowest deep power-down current.
5. See Section 4.2 for read identifier code data.
6. Command writes involving block erase, write, or lock-bit configuration are reliably executed when $V_{PP} = V_{PPH1/2/3}$ and $V_{CC} = V_{CC2/3}$. Block erase, byte write, or lock-bit configuration with $V_{CC} < 3.0V$ or $V_{IH} < RP# < V_{HH}$ produce spurious results and should not be attempted.
7. Refer to Table 4 for valid D_{IN} during a write operation.
8. Don't use the timing both OE# and WE# are V_{IL}.

Table 4. Command Definitions⁽⁹⁾

Command	Bus Cycles Req'd.	Notes	First Bus Cycle			Second Bus Cycle		
			Oper ⁽¹⁾	Addr ⁽²⁾	Data ⁽³⁾	Oper ⁽¹⁾	Addr ⁽²⁾	Data ⁽³⁾
Read Array/Reset	1		Write	X	FFH			
Read Identifier Codes	≥2	4	Write	X	90H	Read	IA	ID
Read Status Register	2		Write	X	70H	Read	X	SRD
Clear Status Register	1		Write	X	50H			
Block Erase	2	5	Write	BA	20H	Write	BA	D0H
Byte Write	2	5,6	Write	WA	40H or 10H	Write	WA	WD
Block Erase and Byte Write Suspend	1	5	Write	X	B0H			
Block Erase and Byte Write Resume	1	5	Write	X	D0H			
Set Block Lock-Bit	2	7	Write	BA	60H	Write	BA	01H
Set Master Lock-Bit	2	7	Write	X	60H	Write	X	F1H
Clear Block Lock-Bits	2	8	Write	X	60H	Write	X	D0H

NOTES:

- BUS operations are defined in Table 3.
- X=Any valid address within the device.
IA=Identifier Code Address: see Figure 4.
BA=Address within the block being erased or locked.
WA=Address of memory location to be written.
- SRD=Data read from status register. See Table 7 for a description of the status register bits.
WD=Data to be written at location WA. Data is latched on the rising edge of WE# or CE# (whichever goes high first).
ID=Data read from identifier codes.
- Following the Read Identifier Codes command, read operations access manufacturer, device, block lock, and master lock codes. See Section 4.2 for read identifier code data.
- If the block is locked, RP# must be at V_{HH} to enable block erase or byte write operations. Attempts to issue a block erase or byte write to a locked block while RP# is V_{IH}.
- Either 40H or 10H are recognized by the WSM as the byte write setup.
- If the master lock-bit is set, RP# must be at V_{HH} to set a block lock-bit. RP# must be at V_{HH} to set the master lock-bit. If the master lock-bit is not set, a block lock-bit can be set while RP# is V_{IH}.
- If the master lock-bit is set, RP# must be at V_{HH} to clear block lock-bits. The clear block lock-bits operation simultaneously clears all block lock-bits. If the master lock-bit is not set, the Clear Block Lock-Bits command can be done while RP# is V_{IH}.
- Commands other than those shown above are reserved by SHARP for future device implementations and should not be used.

4.1 Read Array Command

Upon initial device power-up and after exit from deep power-down mode, the device defaults to read array mode. This operation is also initiated by writing the Read Array command. The device remains enabled for reads until another command is written. Once the internal WSM has started a block erase, byte write or lock-bit configuration, the device will not recognize the Read Array command until the WSM completes its operation unless the WSM is suspended via an Erase Suspend or Byte Write Suspend command. The Read Array command functions independently of the V_{PP} voltage and $RP\#$ can be V_{IH} or V_{HH} .

4.2 Read Identifier Codes Command

The identifier code operation is initiated by writing the Read Identifier Codes command. Following the command write, read cycles from addresses shown in Figure 4 retrieve the manufacturer, device, block lock configuration and master lock configuration codes (see Table 5 for identifier code values). To terminate the operation, write another valid command. Like the Read Array command, the Read Identifier Codes command functions independently of the V_{PP} voltage and $RP\#$ can be V_{IH} or V_{HH} . Following the Read Identifier Codes command, the following information can be read:

Table 5. Identifier Codes

Code	Address	Data
Manufacture Code	00000	89
Device Code	00001	A6
Block Lock Configuration	X0002 ⁽¹⁾	
•Block is Unlocked		DQ ₀ =0
•Block is Locked		DQ ₀ =1
•Reserved for Future Use		DQ ₁₋₇
Master Lock Configuration	00003	
•Device is Unlocked		DQ ₀ =0
•Device is Locked		DQ ₀ =1
•Reserved for Future Use		DQ ₁₋₇

NOTE:

1. X selects the specific block lock configuration code to be read. See Figure 4 for the device identifier code memory map.

4.3 Read Status Register Command

The status register may be read to determine when a block erase, byte write, or lock-bit configuration is complete and whether the operation completed successfully. It may be read at any time by writing the Read Status Register command. After writing this command, all subsequent read operations output data from the status register until another valid command is written. The status register contents are latched on the falling edge of $OE\#$ or $CE\#$, whichever occurs. $OE\#$ or $CE\#$ must toggle to V_{IH} before further reads to update the status register latch. The Read Status Register command functions independently of the V_{PP} voltage. $RP\#$ can be V_{IH} or V_{HH} .

4.4 Clear Status Register Command

Status register bits SR.5, SR.4, SR.3, and SR.1 are set to "1"s by the WSM and can only be reset by the Clear Status Register command. These bits indicate various failure conditions (see Table 7). By allowing system software to reset these bits, several operations (such as cumulatively erasing or locking multiple blocks or writing several bytes in sequence) may be performed. The status register may be polled to determine if an error occurred during the sequence.

To clear the status register, the Clear Status Register command (50H) is written. It functions independently of the applied V_{PP} Voltage. $RP\#$ can be V_{IH} or V_{HH} . This command is not functional during block erase or byte write suspend modes.

4.5 Block Erase Command

Erase is executed one block at a time and initiated by a two-cycle command. A block erase setup is first written, followed by an block erase confirm. This command sequence requires appropriate sequencing and an address within the block to be erased (erase changes all block data to FFH). Block preconditioning, erase, and verify are handled internally by the WSM (invisible to the system). After the two-cycle block erase sequence is written, the device automatically outputs status register data when read (see Figure 5). The CPU can detect block erase completion by analyzing the output data of the $RY/BY\#$ pin or status register bit SR.7.

When the block erase is complete, status register bit SR.5 should be checked. If a block erase error is detected, the status register should be cleared before system software attempts corrective actions. The CUI remains in read status register mode until a new command is issued.

This two-step command sequence of set-up followed by execution ensures that block contents are not accidentally erased. An invalid Block Erase command sequence will result in both status register bits SR.4 and SR.5 being set to "1". Also, reliable block erasure can only occur when $V_{CC}=V_{CC2/3}$ and $V_{PP}=V_{PPH1/2/3}$. In the absence of this high voltage, block contents are protected against erasure. If block erase is attempted while $V_{PP}\leq V_{PPLK}$, SR.3 and SR.5 will be set to "1". Successful block erase requires that the corresponding block lock-bit be cleared or, if set, that $RP#=V_{HH}$. If block erase is attempted when the corresponding block lock-bit is set and $RP#=V_{IH}$, SR.1 and SR.5 will be set to "1". Block erase operations with $V_{IH}<RP#<V_{HH}$ produce spurious results and should not be attempted.

4.6 Byte Write Command

Byte write is executed by a two-cycle command sequence. Byte write setup (standard 40H or alternate 10H) is written, followed by a second write that specifies the address and data (latched on the rising edge of WE#). The WSM then takes over, controlling the byte write and write verify algorithms internally. After the byte write sequence is written, the device automatically outputs status register data when read (see Figure 6). The CPU can detect the completion of the byte write event by analyzing the RY/BY# pin or status register bit SR.7.

When byte write is complete, status register bit SR.4 should be checked. If byte write error is detected, the status register should be cleared. The internal WSM verify only detects errors for "1"s that do not successfully write to "0"s. The CUI remains in read status register mode until it receives another command.

Reliable byte writes can only occur when $V_{CC}=V_{CC2/3}$ and $V_{PP}=V_{PPH1/2/3}$. In the absence of this high voltage, memory contents are protected against byte writes. If byte write is attempted while $V_{PP}\leq V_{PPLK}$, status register bits SR.3 and SR.4 will be set to "1". Successful byte write requires that the corresponding

block lock-bit be cleared or, if set, that $RP#=V_{HH}$. If byte write is attempted when the corresponding block lock-bit is set and $RP#=V_{IH}$, SR.1 and SR.4 will be set to "1". Byte write operations with $V_{IH}<RP#<V_{HH}$ produce spurious results and should not be attempted.

4.7 Block Erase Suspend Command

The Block Erase Suspend command allows block-erase interruption to read or byte-write data in another block of memory. Once the block-erase process starts, writing the Block Erase Suspend command requests that the WSM suspend the block erase sequence at a predetermined point in the algorithm. The device outputs status register data when read after the Block Erase Suspend command is written. Polling status register bits SR.7 and SR.6 can determine when the block erase operation has been suspended (both will be set to "1"). RY/BY# will also transition to V_{OH} . Specification t_{WHRH2} defines the block erase suspend latency.

At this point, a Read Array command can be written to read data from blocks other than that which is suspended. A Byte Write command sequence can also be issued during erase suspend to program data in other blocks. Using the Byte Write Suspend command (see Section 4.8), a byte write operation can also be suspended. During a byte write operation with block erase suspended, status register bit SR.7 will return to "0" and the RY/BY# output will transition to V_{OL} . However, SR.6 will remain "1" to indicate block erase suspend status.

The only other valid commands while block erase is suspended are Read Status Register and Block Erase Resume. After a Block Erase Resume command is written to the flash memory, the WSM will continue the block erase process. Status register bits SR.6 and SR.7 will automatically clear and RY/BY# will return to V_{OL} . After the Erase Resume command is written, the device automatically outputs status register data when read (see Figure 7). V_{PP} must remain at $V_{PPH1/2/3}$ (the same V_{PP} level used for block erase) while block erase is suspended. $RP\#$ must also remain at V_{IH} or V_{HH} (the same $RP\#$ level used for block erase). Block erase cannot resume until byte write operations initiated during block erase suspend have completed.

4.8 Byte Write Suspend Command

The Byte Write Suspend command allows byte write interruption to read data in other flash memory locations. Once the byte write process starts, writing the Byte Write Suspend command requests that the WSM suspend the byte write sequence at a predetermined point in the algorithm. The device continues to output status register data when read after the Byte Write Suspend command is written. Polling status register bits SR.7 and SR.2 can determine when the byte write operation has been suspended (both will be set to "1"). RY/BY# will also transition to V_{OH} . Specification t_{WHRH1} defines the byte write suspend latency.

At this point, a Read Array command can be written to read data from locations other than that which is suspended. The only other valid commands while byte write is suspended are Read Status Register and Byte Write Resume. After Byte Write Resume command is written to the flash memory, the WSM will continue the byte write process. Status register bits SR.2 and SR.7 will automatically clear and RY/BY# will return to V_{OL} . After the Byte Write Resume command is written, the device automatically outputs status register data when read (see Figure 8). V_{PP} must remain at $V_{PPH1/2/3}$ (the same V_{PP} level used for byte write) while in byte write suspend mode. RP# must also remain at V_{IH} or V_{HH} (the same RP# level used for byte write).

4.9 Set Block and Master Lock-Bit Commands

A flexible block locking and unlocking scheme is enabled via a combination of block lock-bits and a master lock-bit. The block lock-bits gate program and erase operations while the master lock-bit gates block-lock bit modification. With the master lock-bit not set, individual block lock-bits can be set using the Set Block Lock-Bit command. The Set Master Lock-Bit command, in conjunction with RP#= V_{HH} , sets the master lock-bit. After the master lock-bit is set, subsequent setting of block lock-bits requires both the Set Block Lock-Bit command and V_{HH} on

the RP# pin. See Table 6 for a summary of hardware and software write protection options.

Set block lock-bit and master lock-bit are executed by a two-cycle command sequence. The set block or master lock-bit setup along with appropriate block or device address is written followed by either the set block lock-bit confirm (and an address within the block to be locked) or the set master lock-bit confirm (and any device address). The WSM then controls the set lock-bit algorithm. After the sequence is written, the device automatically outputs status register data when read (see Figure 9). The CPU can detect the completion of the set lock-bit event by analyzing the RY/BY# pin output or status register bit SR.7.

When the set lock-bit operation is complete, status register bit SR.4 should be checked. If an error is detected, the status register should be cleared. The CUI will remain in read status register mode until a new command is issued.

This two-step sequence of set-up followed by execution ensures that lock-bits are not accidentally set. An invalid Set Block or Master Lock-Bit command will result in status register bits SR.4 and SR.5 being set to "1". Also, reliable operations occur only when $V_{CC}=V_{CC2/3}$ and $V_{PP}=V_{PPH1/2/3}$. In the absence of this high voltage, lock-bit contents are protected against alteration.

A successful set block lock-bit operation requires that the master lock-bit be cleared or, if the master lock-bit is set, that RP#= V_{HH} . If it is attempted with the master lock-bit set and RP#= V_{IH} , SR.1 and SR.4 will be set to "1" and the operation will fail. Set block lock-bit operations while $V_{IH}<RP#<V_{HH}$ produce spurious results and should not be attempted. A successful set master lock-bit operation requires that RP#= V_{HH} . If it is attempted with RP#= V_{IH} , SR.1 and SR.4 will be set to "1" and the operation will fail. Set master lock-bit operations with $V_{IH}<RP#<V_{HH}$ produce spurious results and should not be attempted.

4.10 Clear Block Lock-Bits Command

All set block lock-bits are cleared in parallel via the Clear Block Lock-Bits command. With the master lock-bit not set, block lock-bits can be cleared using only the Clear Block Lock-Bits command. If the master lock-bit is set, clearing block lock-bits requires both the Clear Block Lock-Bits command and V_{HH} on the RP# pin. See Table 6 for a summary of hardware and software write protection options.

Clear block lock-bits operation is executed by a two-cycle command sequence. A clear block lock-bits setup is first written. After the command is written, the device automatically outputs status register data when read (see Figure 10). The CPU can detect completion of the clear block lock-bits event by analyzing the RY/BY# Pin output or status register bit SR.7.

When the operation is complete, status register bit SR.5 should be checked. If a clear block lock-bit error is detected, the status register should be cleared. The CUI will remain in read status register mode until another command is issued.

This two-step sequence of set-up followed by execution ensures that block lock-bits are not accidentally cleared. An invalid Clear Block Lock-Bits command sequence will result in status register bits SR.4 and SR.5 being set to "1". Also, a reliable clear block lock-bits operation can only occur when $V_{CC}=V_{CC2/3}$ and $V_{PP}=V_{PPH1/2/3}$. If a clear block lock-bits operation is attempted while $V_{PP} \leq V_{PPLK}$, SR.3 and SR.5 will be set to "1". In the absence of this high voltage, the block lock-bits content are protected against alteration. A successful clear block lock-bits operation requires that the master lock-bit is not set or, if the master lock-bit is set, that $RP\#=V_{HH}$. If it is attempted with the master lock-bit set and $RP\#=V_{IH}$, SR.1 and SR.5 will be set to "1" and the operation will fail. A clear block lock-bits operation with $V_{IH} < RP\# < V_{HH}$ produce spurious results and should not be attempted.

If a clear block lock-bits operation is aborted due to V_{PP} or V_{CC} transitioning out of valid range or RP# active transition, block lock-bit values are left in an undetermined state. A repeat of clear block lock-bits is required to initialize block lock-bit contents to known values. Once the master lock-bit is set, it cannot be cleared.

Table 6. Write Protection Alternatives

Operation	Master Lock-Bit	Block Lock-Bit	RP#	Effect
Block Erase or Byte Write	X	0	V_{IH} or V_{HH}	Block Erase and Byte Write Enabled
		1	V_{IH}	Block is Locked. Block Erase and Byte Write Disabled
			V_{HH}	Block Lock-Bit Override. Block Erase and Byte Write Enabled
Set Block Lock-Bit	0	X	V_{IH} or V_{HH}	Set Block Lock-Bit Enabled
	1	X	V_{IH}	Master Lock-Bit is Set. Set Block Lock-Bit Disabled
			V_{HH}	Master Lock-Bit Override. Set Block Lock-Bit Enabled
Set Master Lock-Bit	X	X	V_{IH}	Set Master Lock-Bit Disabled
			V_{HH}	Set Master Lock-Bit Enabled
Clear Block Lock-Bits	0	X	V_{IH} or V_{HH}	Clear Block Lock-Bits Enabled
	1	X	V_{IH}	Master Lock-Bit is Set. Clear Block Lock-Bits Disabled
			V_{HH}	Master Lock-Bit Override. Clear Block Lock-Bits Enabled

Table 7. Status Register Definition

WSMS	ESS	ECLBS	BWSLBS	VPPS	BWSS	DPS	R
7	6	5	4	3	2	1	0
<p>SR.7 = WRITE STATE MACHINE STATUS 1 = Ready 0 = Busy</p> <p>SR.6 = ERASE SUSPEND STATUS 1 = Block Erase Suspended 0 = Block Erase in Progress/Completed</p> <p>SR.5 = ERASE AND CLEAR LOCK-BITS STATUS 1 = Error in Block Erasure or Clear Lock-Bits 0 = Successful Block Erase or Clear Lock-Bits</p> <p>SR.4 = BYTE WRITE AND SET LOCK-BIT STATUS 1 = Error in Byte Write or Set Master/Block Lock-Bit 0 = Successful Byte Write or Set Master/Block Lock-Bit</p> <p>SR.3 = V_{PP} STATUS 1 = V_{PP} Low Detect, Operation Abort 0 = V_{PP} OK</p> <p>SR.2 = BYTE WRITE SUSPEND STATUS 1 = Byte Write Suspended 0 = Byte Write in Progress/Completed</p> <p>SR.1 = DEVICE PROTECT STATUS 1 = Master Lock-Bit, Block Lock-Bit and/or RP# Lock Detected, Operation Abort 0 = Unlock</p> <p>SR.0 = RESERVED FOR FUTURE ENHANCEMENTS</p>				<p>NOTES:</p> <p>Check RY/BY# or SR.7 to determine block erase, byte write, or lock-bit configuration completion. SR.6-0 are invalid while SR.7="0".</p> <p>If both SR.5 and SR.4 are "1"s after a block erase or lock-bit configuration attempt, an improper command sequence was entered.</p> <p>SR.3 does not provide a continuous indication of V_{PP} level. The WSM interrogates and indicates the V_{PP} level only after Block Erase, Byte Write, Set Block/Master Lock-Bit, or Clear Block Lock-Bits command sequences. SR.3 is not guaranteed to reports accurate feedback only when V_{PP}≠V_{PPH1/2/3}.</p> <p>SR.1 does not provide a continuous indication of master and block lock-bit values. The WSM interrogates the master lock-bit, block lock-bit, and RP# only after Block Erase, Byte Write, or Lock-Bit configuration command sequences. It informs the system, depending on the attempted operation, if the block lock-bit is set, master lock-bit is set, and/or RP# is not V_{HH}. Reading the block lock and master lock configuration codes after writing the Read Identifier Codes command indicates master and block lock-bit status.</p> <p>SR.0 is reserved for future use and should be masked out when polling the status register.</p>			

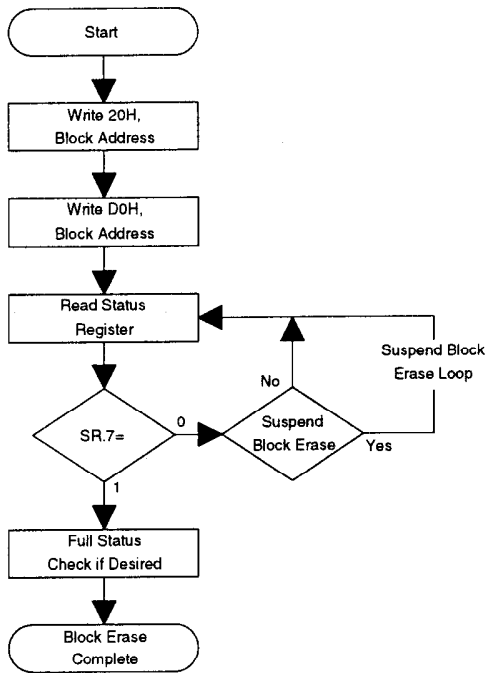

Bus Operation	Command	Comments
Write	Erase Setup	Data=20H Addr=Within Block to be Erased
Write	Erase Confirm	Data=00H Addr=Within Block to be Erased
Read		Status Register Data
Standby		Check SR.7 1=WSM Ready 0=WSM Busy

Repeat for subsequent block erasures.
Full status check can be done after each block erase or after a sequence of block erasures.
Write FFH after the last operation to place device in read array mode.

FULL STATUS CHECK PROCEDURE

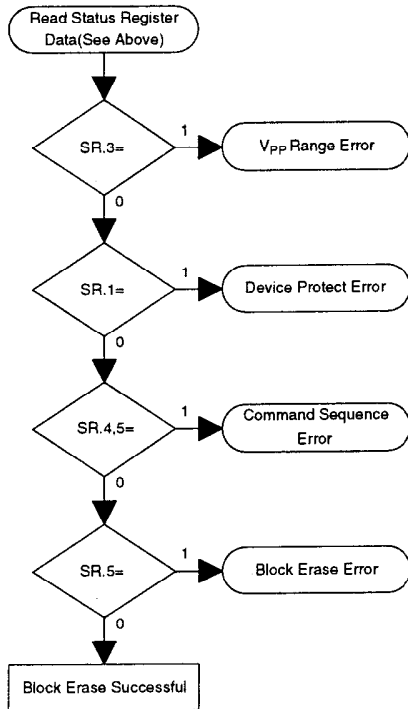

Bus Operation	Command	Comments
Standby		Check SR.3 1=Vpp Error Detect
Standby		Check SR.1 1=Device Protect Detect RP#=Vpp,Block Lock-Bit is Set Only required for systems implementing lock-bit configuration
Standby		Check SR.4,5 Both 1=Command Sequence Error
Standby		Check SR.5 1=Block Erase Error

SR.5,SR.4,SR.3 and SR.1 are only cleared by the Clear Status Register Command in cases where multiple blocks are erased before full status is checked.
If error is detected, clear the Status Register before attempting retry or other error recovery.

Figure 5. Automated Block Erase Flowchart

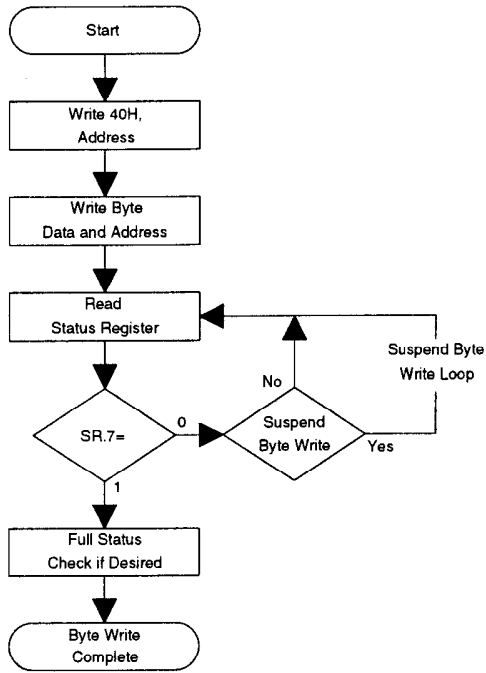

Bus Operation	Command	Comments
Write	Setup Byte Write	Data=40H Addr=Location to Be Written
Write	Byte Write	Data=Data to Be Written Addr=Location to Be Written
Read		Status Register Data
Standby		Check SR.7 1=WSM Ready 0=WSM Busy

Repeat for subsequent byte writes.
SR full status check can be done after each byte write, or after a sequence of byte writes.
Write FFH after the last byte write operation to place device in read array mode.

FULL STATUS CHECK PROCEDURE

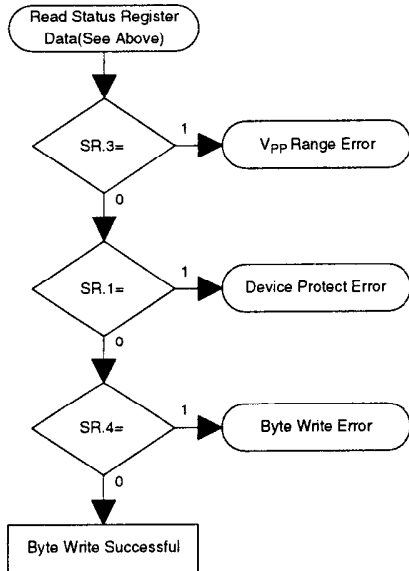

Bus Operation	Command	Comments
Standby		Check SR.3 1=Vpp Error Detect
Standby		Check SR.1 1=Device Protect Detect RP#=Vpp, Block Lock-Bit is Set Only required for systems implementing lock-bit configuration
Standby		Check SR.4 1=Data Write Error

SR.4,SR.3 and SR.1 are only cleared by the Clear Status Register command in cases where multiple locations are written before full status is checked.
If error is detected, clear the Status Register before attempting retry or other error recovery.

Figure 6. Automated Byte Write Flowchart

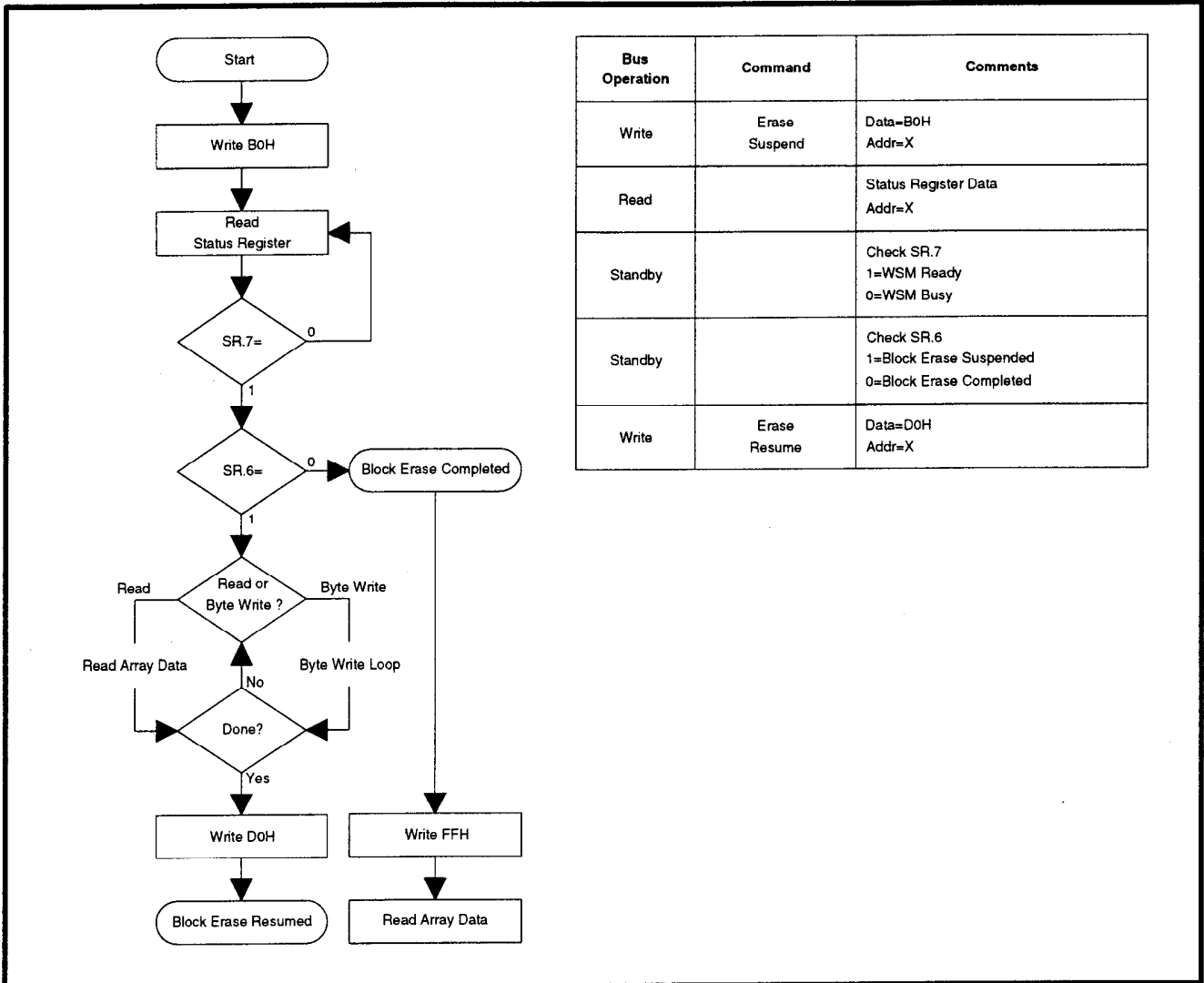

Figure 7. Block Erase Suspend/Resume Flowchart

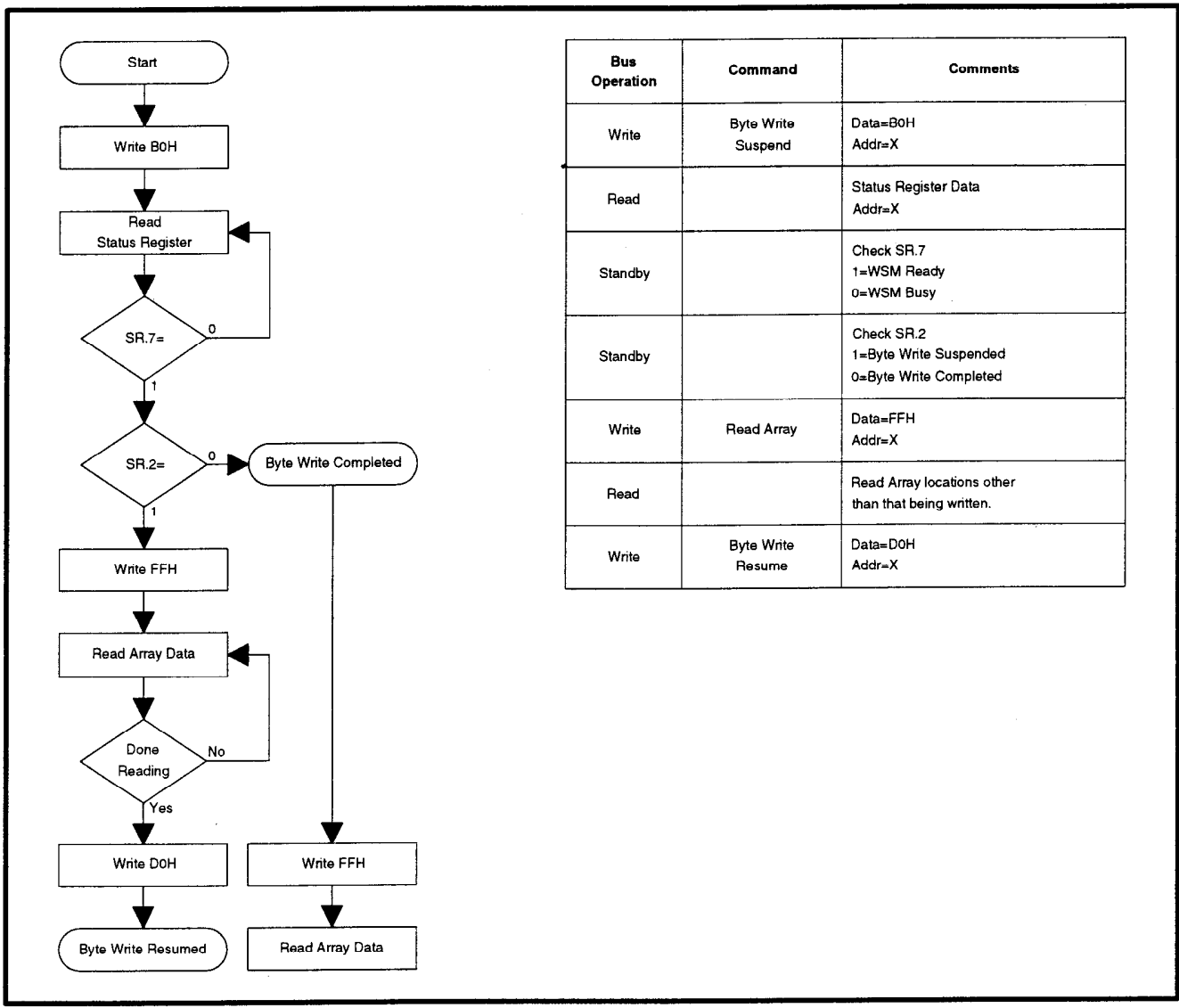

Figure 8. Byte Write Suspend/Resume Flowchart

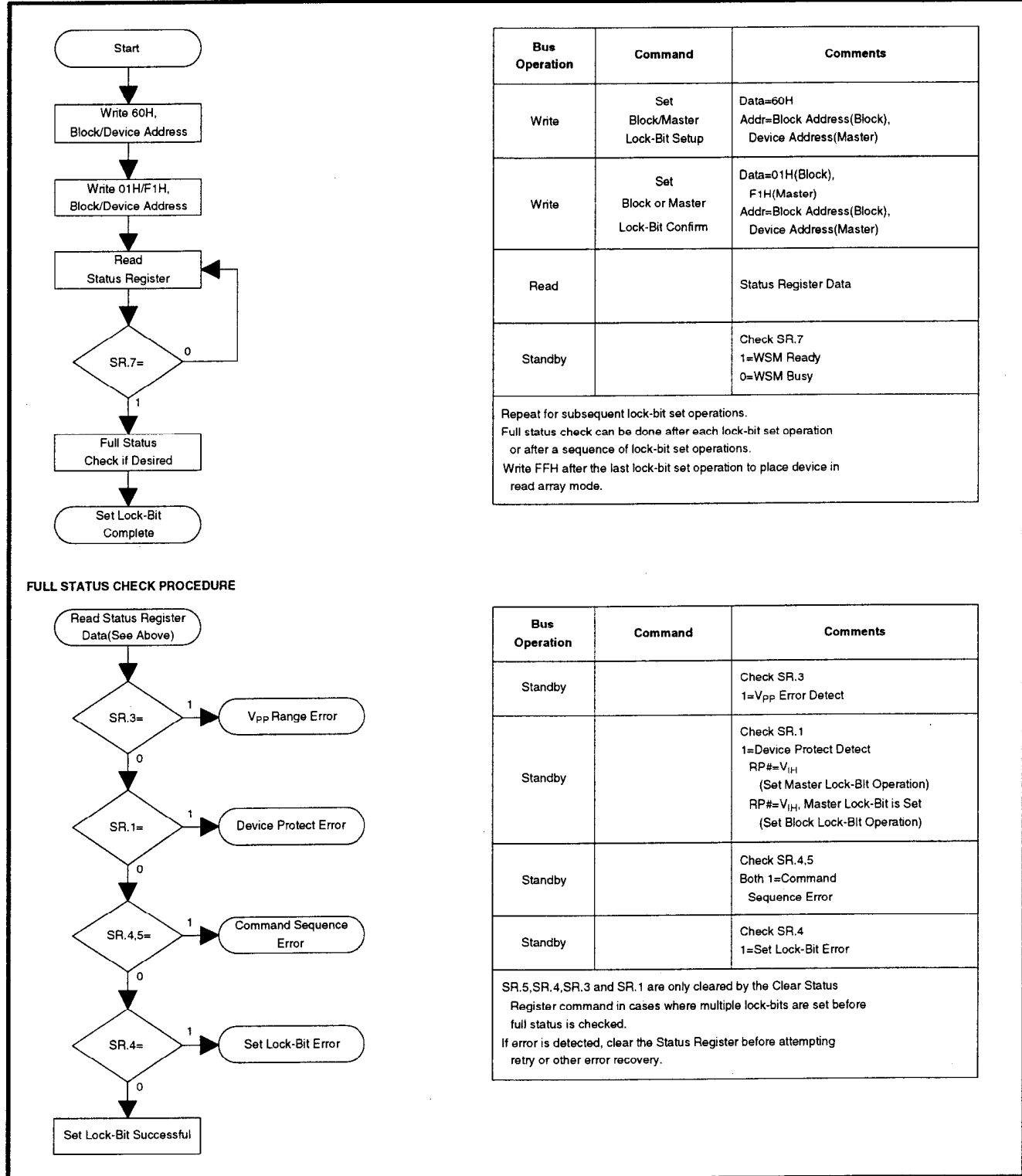
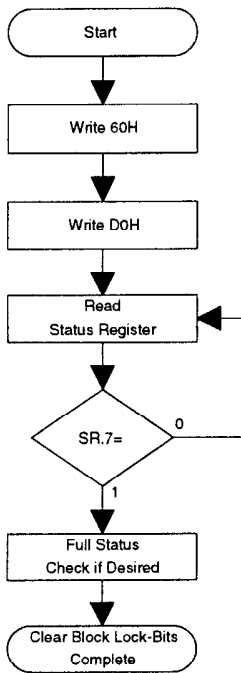

Figure 9. Set Block and Master Lock-Bit Flowchart



Bus Operation	Command	Comments
Write	Clear Block Lock-Bits Setup	Data=60H Addr=X
Write	Clear Block Lock-Bits Confirm	Data=D0H Addr=X
Read		Status Register Data
Standby		Check SR.7 1=WSM Ready 0=WSM Busy

Write FFH after the Clear Block Lock-Bits operation to place device in read array mode.

FULL STATUS CHECK PROCEDURE

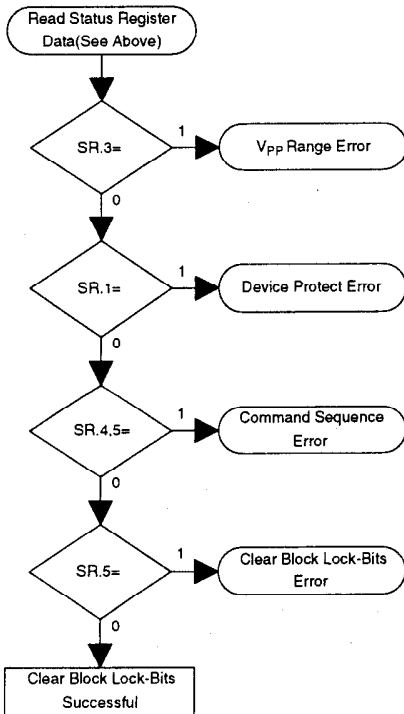

Bus Operation	Command	Comments
Standby		Check SR.3 1=Vpp Error Detect
Standby		Check SR.1 1=Device Protect Detect RP#=V _{ih} , Master Lock-Bit is Set
Standby		Check SR.4.5 Both 1=Command Sequence Error
Standby		Check SR.5 1=Clear Block Lock-Bits Error

SR.5, SR.4, SR.3 and SR.1 are only cleared by the Clear Status Register command.
If error is detected, clear the Status Register before attempting retry or other error recovery.

Figure 10. Clear Block Lock-Bits Flowchart

5 DESIGN CONSIDERATIONS

5.1 Three-Line Output Control

The device will often be used in large memory arrays. SHARP provides three control inputs to accommodate multiple memory connections. Three-line control provides for:

- a. Lowest possible memory power dissipation.
- b. Complete assurance that data bus contention will not occur.

To use these control inputs efficiently, an address decoder should enable CE# while OE# should be connected to all memory devices and the system's READ# control line. This assures that only selected memory devices have active outputs while deselected memory devices are in standby mode. RP# should be connected to the system POWERGOOD signal to prevent unintended writes during system power transitions. POWERGOOD should also toggle during system reset.

5.2 RY/BY# and Block Erase, Byte Write, and Lock-Bit Configuration Polling

RY/BY# is a full CMOS output that provides a hardware method of detecting block erase, byte write and lock-bit configuration completion. It transitions low after block erase, byte write, or lock-bit configuration commands and returns to V_{OH} when the WSM has finished executing the internal algorithm.

RY/BY# can be connected to an interrupt input of the system CPU or controller. It is active at all times.

RY/BY# is also V_{OH} when the device is in block erase suspend (with byte write inactive), byte write suspend or deep power-down modes.

5.3 Power Supply Decoupling

Flash memory power switching characteristics require careful device decoupling. System designers are interested in three supply current issues; standby current levels, active current levels and transient peaks produced by falling and rising edges of CE# and OE#. Transient current magnitudes depend on the device outputs' capacitive and inductive loading. Two-line control and proper decoupling capacitor selection will suppress transient voltage peaks. Each device should have a 0.1 μF ceramic capacitor connected between its V_{CC} and GND and between its V_{PP} and GND. These high-frequency, low inductance capacitors should be placed as close as possible to package leads. Additionally, for every eight devices, a 4.7 μF electrolytic capacitor should be placed at the array's power supply connection between V_{CC} and GND. The bulk capacitor will overcome voltage slumps caused by PC board trace inductance.

5.4 V_{PP} Trace on Printed Circuit Boards

Updating flash memories that reside in the target system requires that the printed circuit board designer pay attention to the V_{PP} Power supply trace. The V_{PP} pin supplies the memory cell current for byte writing and block erasing. Use similar trace widths and layout considerations given to the V_{CC} power bus. Adequate V_{PP} supply traces and decoupling will decrease V_{PP} voltage spikes and overshoots.

5.5 V_{CC} , V_{PP} , RP# Transitions

Block erase, byte write and lock-bit configuration are not guaranteed if V_{PP} falls outside of a valid $V_{PPH1/2/3}$ range, V_{CC} falls outside of a valid $V_{CC2/3}$ range, or $RP\# \neq V_{IH}$ or V_{HH} . If V_{PP} error is detected, status register bit SR.3 is set to "1" along with SR.4 or SR.5, depending on the attempted operation. If RP# transitions to V_{IL} during block erase, byte write, or lock-bit configuration, RY/BY# will remain low until the reset operation is complete. Then, the operation will abort and the device will enter deep power-down. The aborted operation may leave data partially altered. Therefore, the command sequence must be repeated after normal operation is restored. Device power-off or RP# transitions to V_{IL} clear the status register.

The CUI latches commands issued by system software and is not altered by V_{PP} or CE# transitions or WSM actions. Its state is read array mode upon power-up, after exit from deep power-down or after V_{CC} transitions below V_{LKO} .

After block erase, byte write, or lock-bit configuration, even after V_{PP} transitions down to V_{PPLK} , the CUI must be placed in read array mode via the Read Array command if subsequent access to the memory array is desired.

5.6 Power-Up/Down Protection

The device is designed to offer protection against accidental block erasure, byte writing, or lock-bit configuration during power transitions. Upon power-up, the device is indifferent as to which power

supply (V_{PP} or V_{CC}) powers-up first. Internal circuitry resets the CUI to read array mode at power-up.

A system designer must guard against spurious writes for V_{CC} voltages above V_{LKO} when V_{PP} is active. Since both WE# and CE# must be low for a command write, driving either to V_{IH} will inhibit writes. The CUI's two-step command sequence architecture provides added level of protection against data alteration.

In-system block lock and unlock capability prevents inadvertent data alteration. The device is disabled while $RP\# = V_{IL}$ regardless of its control inputs state.

5.7 Power Dissipation

When designing portable systems, designers must consider battery power consumption not only during device operation, but also for data retention during system idle time. Flash memory's nonvolatility increases usable battery life because data is retained when system power is removed.

In addition, deep power-down mode ensures extremely low power consumption even when system power is applied. For example, portable computing products and other power sensitive applications that use an array of devices for solid-state storage can consume negligible power by lowering RP# to V_{IL} standby or sleep modes. If access is again needed, the devices can be read following the t_{PHQV} and t_{PHWL} wake-up cycles required after RP# is first raised to V_{IH} . See AC Characteristics— Read Only and Write Operations and Figures 15, 16 and 17 for more information.

6 ELECTRICAL SPECIFICATIONS

6.1 Absolute Maximum Ratings*

- Operating Temperature
 - During Read, Block Erase, Byte Write and Lock-Bit Configuration 0°C to +70°C⁽¹⁾
 - Temperature under Bias..... -10°C to +80°C
- Storage Temperature..... -65°C to +125°C
- Voltage On Any Pin (except V_{CC}, V_{PP}, and RP#)..... -2.0V to +7.0V⁽²⁾
- V_{CC} Supply Voltage -2.0V to +7.0V⁽²⁾
- V_{PP} Update Voltage during Block Erase, Byte Write and Lock-Bit Configuration -2.0V to +14.0V^(2,3)
- RP# Voltage with Respect to GND during Lock-Bit Configuration Operations -2.0V to +14.0V^(2,3)
- Output Short Circuit Current 100mA⁽⁴⁾

**WARNING: Stressing the device beyond the "Absolute Maximum Ratings" may cause permanent damage. These are stress ratings only. Operation beyond the "Operating Conditions" is not recommended and extended exposure beyond the "Operating Conditions" may affect device reliability.*

NOTES:

1. Operating temperature is for commercial temperature product defined by this specification.
2. All specified voltages are with respect to GND. Minimum DC voltage is -0.5V on input/output pins and -0.2V on V_{CC} and V_{PP} pins. During transitions, this level may undershoot to -2.0V for periods <20ns. Maximum DC voltage on input/output pins and V_{CC} is V_{CC}+0.5V which, during transitions, may overshoot to V_{CC}+2.0V for periods <20ns.
3. Maximum DC voltage on V_{PP} and RP# may overshoot to +14.0V for periods <20ns.
4. Output shorted for no more than one second. No more than one output shorted at a time.

6.2 Operating Conditions

Temperature and V_{CC} Operating Conditions

Symbol	Parameter	Notes	Min.	Max.	Unit	Test Condition
T _A	Operating Temperature		0	+70	°C	Ambient Temperature
V _{CC1}	V _{CC} Supply Voltage (2.7V-3.6V)	1	2.7	3.6	V	
V _{CC2}	V _{CC} Supply Voltage (3.3V±0.3V)		3.0	3.6	V	
V _{CC3}	V _{CC} Supply Voltage (5V±0.5V)		4.50	5.50	V	

NOTE:

1. Block erase, byte write and lock-bit configuration operations with V_{CC}<3.0V should not be attempted.

6.2.1 CAPACITANCE⁽¹⁾

T_A=+25°C, f=1MHz

Symbol	Parameter	Typ.	Max.	Unit	Condition
C _{IN}	Input Capacitance	6	8	pF	V _{IN} =0.0V
C _{OUT}	Output Capacitance	8	12	pF	V _{OUT} =0.0V

NOTE:

1. Sampled, not 100% tested.

6.2.2 AC INPUT/OUTPUT TEST CONDITIONS

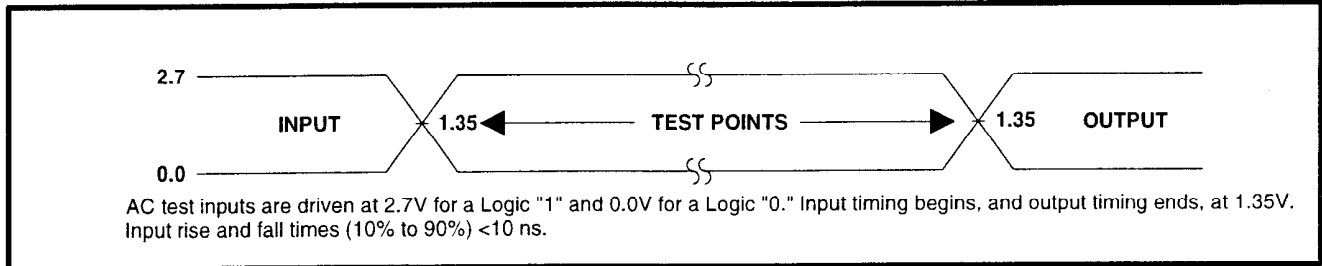

Figure 11. Transient Input/Output Reference Waveform for $V_{CC}=2.7V-3.6V$

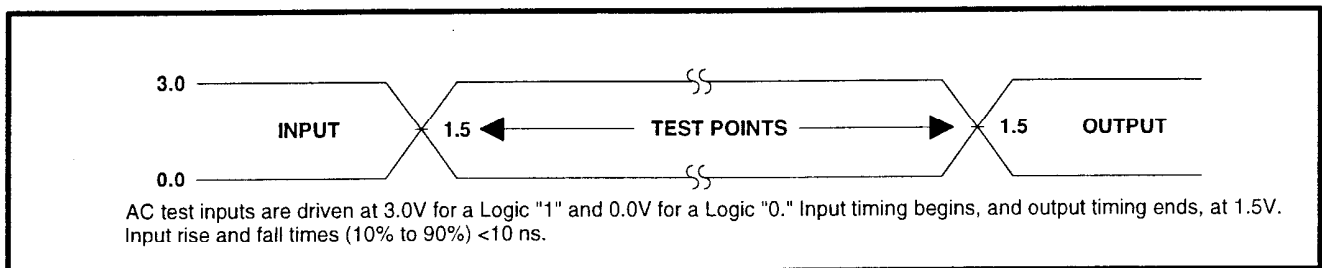

Figure 12. Transient Input/Output Reference Waveform for $V_{CC}=3.3V\pm 0.3V$

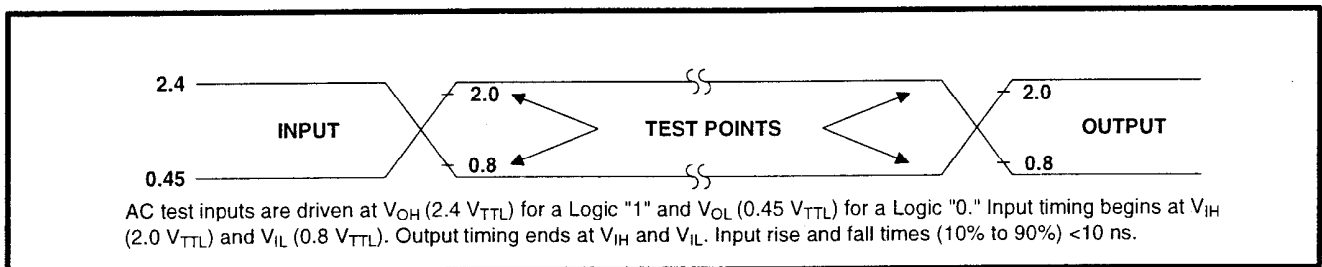

Figure 13. Transient Input/Output Reference Waveform for $V_{CC}=5V\pm 0.5V$

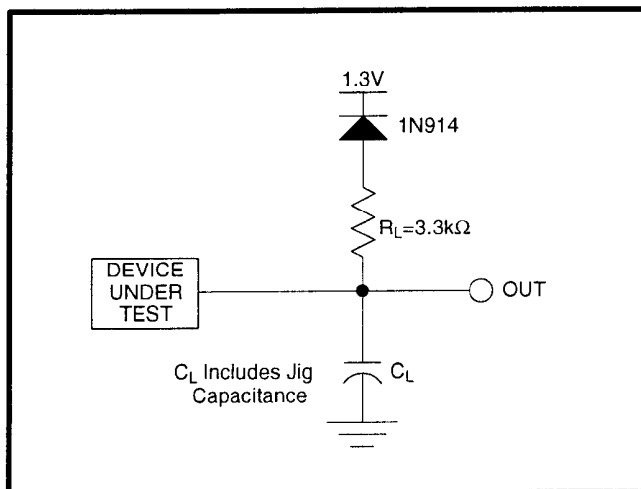

Figure 14. Transient Equivalent Testing Load Circuit

Test Configuration Capacitance Loading Value

Test Configuration	C_L (pF)
$V_{CC}=3.3V\pm 0.3V, 2.7V-3.6V$	50
$V_{CC}=5V\pm 0.5V$	100

6.2.3 DC CHARACTERISTICS

DC Characteristics

Sym.	Parameter	Notes	V _{CC} =2.7V		V _{CC} =3.3V		V _{CC} =5V		Unit	Test Conditions
			Typ.	Max.	Typ.	Max.	Typ.	Max.		
I _{LI}	Input Load Current	1		±0.5		±0.5		±1	μA	V _{CC} =V _{CC} Max. V _{IN} =V _{CC} or GND
I _{LO}	Output Leakage Current	1		±0.5		±0.5		±10	μA	V _{CC} =V _{CC} Max. V _{OUT} =V _{CC} or GND
I _{CCS}	V _{CC} Standby Current	1,3,6	20	100	20	100	25	100	μA	CMOS Inputs V _{CC} =V _{CC} Max. CE#=RP#=V _{CC} ±0.2V
			0.1	2	0.2	2	0.4	2	mA	TTL Inputs V _{CC} =V _{CC} Max. CE#=RP#=V _{IH}
I _{CCD}	V _{CC} Deep Power-Down Current	1		10		10		10	μA	RP#=GND±0.2V I _{OUT} (RY/BY#)=0mA
I _{CCR}	V _{CC} Read Current	1,5,6	6	12	7	12	17	35	mA	CMOS Inputs V _{CC} =V _{CC} Max. CE#=GND f=5MHz(3.3V, 2.7V), * 8MHz(5V) I _{OUT} =0mA
			7	18	8	18	20	50	mA	TTL Inputs V _{CC} =V _{CC} Max. CE#=GND f=5MHz(3.3V, 2.7V), 8MHz(5V) I _{OUT} =0mA
I _{CCW}	V _{CC} Byte Write or Set Lock-Bit Current	1,7	—	—		17	—	—	mA	V _{PP} =3.3V±0.3V
			—	—		17	—	35	mA	V _{PP} =5.0V±0.5V
			—	—		12	—	30	mA	V _{PP} =12.0V±0.6V
I _{CCE}	V _{CC} Block Erase or Clear Block Lock-Bits Current	1,7	—	—		17	—	—	mA	V _{PP} =3.3V±0.3V
			—	—		17	—	30	mA	V _{PP} =5.0V±0.5V
			—	—		12	—	25	mA	V _{PP} =12.0V±0.6V
I _{CCWS} I _{CCES}	V _{CC} Byte Write or Block Erase Suspend Current	1,2	—	—	1	6	1	10	mA	CE#=V _{IH}
I _{PPS} I _{PPR}	V _{PP} Standby or Read Current	1	±2	±15	±2	±15	±2	±15	μA	V _{PP} ≤V _{CC}
			10	200	10	200	10	200	μA	V _{PP} >V _{CC}
I _{PPD}	V _{PP} Deep Power-Down Current	1	0.1	5	0.1	5	0.1	5	μA	RP#=GND±0.2V
I _{PPW}	V _{PP} Byte Write or Set Lock-Bit Current	1,7	—	—		40	—	—	mA	V _{PP} =3.3V±0.3V
			—	—		40	—	40	mA	V _{PP} =5.0V±0.5V
			—	—		15	—	15	mA	V _{PP} =12.0V±0.6V
I _{PPE}	V _{PP} Block Erase or Clear Lock-Bit Current	1,7	—	—		20	—	—	mA	V _{PP} =3.3V±0.3V
			—	—		20	—	20	mA	V _{PP} =5.0V±0.5V
			—	—		15	—	15	mA	V _{PP} =12.0V±0.6V
I _{PPWS} I _{PPES}	V _{PP} Byte Write or Block Erase Suspend Current	1	—	—	10	200	10	200	μA	V _{PP} =V _{PPH1/2/3}

DC Characteristics (Continued)

Sym.	Parameter	Notes	V _{CC} =2.7V		V _{CC} =3.3V		V _{CC} =5V		Unit	Test Conditions
			Min.	Max.	Min.	Max.	Min.	Max.		
V _{IL}	Input Low Voltage	7	-0.5	0.8	-0.5	0.8	-0.5	0.8	V	
V _{IH}	Input High Voltage	7	2.0	V _{CC} +0.5	2.0	V _{CC} +0.5	2.0	V _{CC} +0.5	V	
V _{OL}	Output Low Voltage	3,7		0.4		0.4		0.45	V	V _{CC} =V _{CC} Min. I _{OL} =5.8mA(V _{CC} =5V) I _{OL} =2.0mA (V _{CC} =3.3V, 2.7V)
V _{OH1}	Output High Voltage (TTL)	3,7	2.4		2.4		2.4		V	V _{CC} =V _{CC} Min. I _{OH} =-2.5mA(V _{CC} =5V) I _{OH} =-2.0mA(V _{CC} =3.3V) I _{OH} =-1.5mA(V _{CC} =2.7V)
V _{OH2}	Output High Voltage (CMOS)	3,7	0.85		0.85		0.85		V	V _{CC} =V _{CC} Min. I _{OH} =-2.0mA
			V _{CC} -0.4		V _{CC} -0.4		V _{CC} -0.4		V	V _{CC} =V _{CC} Min. I _{OH} =-100μA
V _{PPLK}	V _{PP} Lockout during Normal Operations	4,7		1.5		1.5		1.5	V	
V _{PPH1}	V _{PP} during Byte Write, Block Erase or Lock-Bit Operations		—	—	3.0	3.6	—	—	V	
V _{PPH2}	V _{PP} during Byte Write, Block Erase or Lock-Bit Operations		—	—	4.5	5.5	4.5	5.5	V	
V _{PPH3}	V _{PP} during Byte Write, Block Erase or Lock-Bit Operations		—	—	11.4	12.6	11.4	12.6	V	
V _{LKO}	V _{CC} Lockout Voltage		2.0		2.0		2.0		V	
V _{HH}	RP# Unlock Voltage	8,9	—	—	11.4	12.6	11.4	12.6	V	Set master lock-bit Override master and block lock-bit

NOTES:

- All currents are in RMS unless otherwise noted. Typical values at nominal V_{CC} voltage and T_A=+25°C.
- I_{CCWS} and I_{CCES} are specified with the device de-selected. If read or byte written while in erase suspend mode, the device's current draw is the sum of I_{CCWS} or I_{CCES} and I_{CCR} or I_{CCW}, respectively.
- Includes RY/BY#.
- Block erases, byte writes, and lock-bit configurations are inhibited when V_{PP} ≤ V_{PPLK}, and not guaranteed in the range between V_{PPLK}(max.) and V_{PPH1}(min.), between V_{PPH1}(max.) and V_{PPH2}(min.), between V_{PPH2}(max.) and V_{PPH3}(min.), and above V_{PPH3}(max.).
- Automatic Power Savings (APS) reduces typical I_{CCR} to 1mA at 5V V_{CC} and 3mA at 2.7V and 3.3V V_{CC} in static operation.
- CMOS inputs are either V_{CC}±0.2V or GND±0.2V. TTL inputs are either V_{IL} or V_{IH}.
- Sampled, not 100% tested.
- Master lock-bit set operations are inhibited when RP#=V_{IH}. Block lock-bit configuration operations are inhibited when the master lock-bit is set and RP#=V_{IH}. Block erases and byte writes are inhibited when the corresponding block-lock bit is set and RP#=V_{IH}. Block erase, byte write, and lock-bit configuration operations are not guaranteed with V_{CC}<3.0V or V_{IH}<RP#<V_{HH} and should not be attempted.
- RP# connection to a V_{HH} supply is allowed for a maximum cumulative period of 80 hours.

6.2.4 AC CHARACTERISTICS - READ-ONLY OPERATIONS⁽¹⁾ $V_{CC}=2.7V-3.6V, T_A=0^{\circ}C \text{ to } +70^{\circ}C$

Sym.	Parameter	Notes	Versions ⁽⁴⁾		Unit
			LH28F008SC-L170		
			Min.	Max.	
t_{AVAV}	Read Cycle Time		170		ns
t_{AVOQV}	Address to Output Delay			170	ns
t_{ELOQV}	CE# to Output Delay	2		170	ns
t_{PHQV}	RP# High to Output Delay			600	ns
t_{GLOQV}	OE# to Output Delay	2		55	ns
t_{ELOQX}	CE# to Output in Low Z	3	0		ns
t_{EHOZ}	CE# High to Output in High Z	3		55	ns
t_{GLOQX}	OE# to Output in Low Z	3	0		ns
t_{GHOZ}	OE# High to Output in High Z	3		25	ns
t_{OH}	Output Hold from Address, CE# or OE# Change, Whichever Occurs First	3	0		ns

NOTE:See 5.0V V_{CC} Read-Only Operations for notes 1 through 4. $V_{CC}=3.3V\pm 0.3V, T_A=0^{\circ}C \text{ to } +70^{\circ}C$

Sym.	Parameter	Notes	Versions ⁽⁴⁾		Unit
			LH28F008SC-L150		
			Min.	Max.	
t_{AVAV}	Read Cycle Time		150		ns
t_{AVOQV}	Address to Output Delay			150	ns
t_{ELOQV}	CE# to Output Delay	2		150	ns
t_{PHQV}	RP# High to Output Delay			600	ns
t_{GLOQV}	OE# to Output Delay	2		55	ns
t_{ELOQX}	CE# to Output in Low Z	3	0		ns
t_{EHOZ}	CE# High to Output in High Z	3		55	ns
t_{GLOQX}	OE# to Output in Low Z	3	0		ns
t_{GHOZ}	OE# High to Output in High Z	3		25	ns
t_{OH}	Output Hold from Address, CE# or OE# Change, Whichever Occurs First	3	0		ns

NOTE:See 5.0V V_{CC} Read-Only Operations for notes 1 through 4.

$V_{CC}=5V\pm 0.5V, T_A=0^{\circ}C \text{ to } +70^{\circ}C$

Versions ⁽⁴⁾		LH28F008SC-L120		Unit
Sym.	Parameter	Notes	Min.	
t_{AVAV}	Read Cycle Time		120	ns
t_{AVOQ}	Address to Output Delay			120
t_{ELQV}	CE# to Output Delay	2		120
t_{PHQV}	RP# High to Output Delay			400
t_{GLQV}	OE# to Output Delay	2		50
t_{ELQX}	CE# to Output in Low Z	3	0	ns
t_{EHOZ}	CE# High to Output in High Z	3		55
t_{GLQX}	OE# to Output in Low Z	3	0	ns
t_{GHOZ}	OE# High to Output in High Z	3		15
t_{OH}	Output Hold from Address, CE# or OE# Change, Whichever Occurs First	3	0	ns

NOTES:

1. See AC Input/Output Reference Waveform for maximum allowable input slew rate.
2. OE# may be delayed up to $t_{ELQV}-t_{GLQV}$ after the falling edge of CE# without impact on t_{ELQV} .
3. Sampled, not 100% tested.
4. See Ordering Information for device speeds (valid operational combinations).

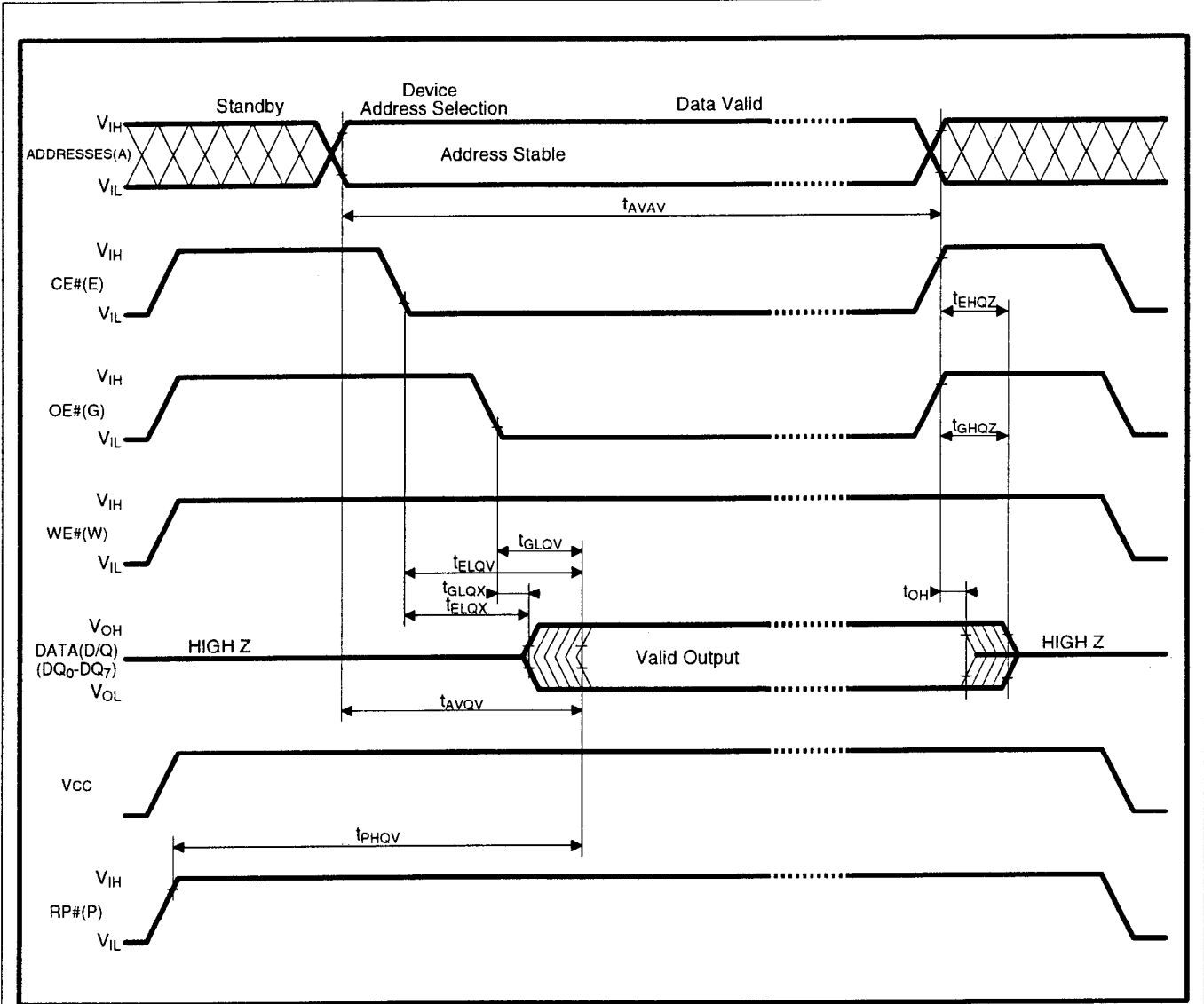

Figure 15. AC Waveform for Read Operations

6.2.5 AC CHARACTERISTICS - WRITE OPERATION⁽¹⁾

$V_{CC}=2.7V-3.6V, T_A=0^{\circ}C \text{ to } +70^{\circ}C$

Versions ⁽⁵⁾			LH28F008SC-L170		Unit
Sym.	Parameter	Notes	Min.	Max.	
t_{AVAV}	Write Cycle Time		170		ns
t_{PHWL}	RP# High Recovery to WE# Going Low	2	1		μs
t_{ELWL}	CE# Setup to WE# Going Low		0		ns
t_{WLWH}	WE# Pulse Width		70		ns
t_{AVWH}	Address Setup to WE# Going High	3	50		ns
t_{DVWH}	Data Setup to WE# Going High	3	50		ns
t_{WHDX}	Data Hold from WE# High		5		ns
t_{WHAX}	Address Hold from WE# High		5		ns
t_{WHEH}	CE# Hold from WE# High		0		ns
t_{WHWL}	WE# Pulse Width High		25		ns
t_{WHGL}	Write Recovery before Read		0		ns

NOTE:

See 5.0V V_{CC} WE#-Controlled Writes for notes 1 through 5.

$V_{CC}=3.3V\pm 0.3V, T_A=0^{\circ}C \text{ to } +70^{\circ}C$

Versions ⁽⁵⁾			LH28F008SC-L150		Unit
Sym.	Parameter	Notes	Min.	Max.	
t_{AVAV}	Write Cycle Time		150		ns
t_{PHWL}	RP# High Recovery to WE# Going Low	2	1		μs
t_{ELWL}	CE# Setup to WE# Going Low		0		ns
t_{WLWH}	WE# Pulse Width		70		ns
t_{PHHWH}	RP# V_{HH} Setup to WE# Going High	2	100		ns
t_{VPWH}	V_{PP} Setup to WE# Going High	2	100		ns
t_{AVWH}	Address Setup to WE# Going High	3	50		ns
t_{DVWH}	Data Setup to WE# Going High	3	50		ns
t_{WHDX}	Data Hold from WE# High		5		ns
t_{WHAX}	Address Hold from WE# High		5		ns
t_{WHEH}	CE# Hold from WE# High		0		ns
t_{WHWL}	WE# Pulse Width High		25		ns
t_{WHRL}	WE# High to RY/BY# Going Low			100	ns
t_{WHGL}	Write Recovery before Read		0		ns
t_{QVVL}	V_{PP} Hold from Valid SRD, RY/BY# High	2,4	0		ns
t_{OVPH}	RP# V_{HH} Hold from Valid SRD, RY/BY# High	2,4	0		ns

NOTE:

See 5V V_{CC} AC Characteristics - Write Operations for Notes 1 through 5.

$V_{CC}=5V\pm 0.5V, T_A=0^{\circ}C \text{ to } +70^{\circ}C$

Versions ⁽⁵⁾		LH28F008SC-L120		Unit	
Sym.	Parameter	Notes	Min.		Max.
t_{AVAV}	Write Cycle Time		120		ns
t_{PHWL}	RP# High Recovery to WE# Going Low	2	1		μ s
t_{ELWL}	CE# Setup to WE# Going Low		0		ns
t_{WLWH}	WE# Pulse Width		50		ns
t_{PHHWH}	RP# V_{HH} Setup to WE# Going High	2	100		ns
t_{PPWH}	V_{PP} Setup to WE# Going High	2	100		ns
t_{AVWH}	Address Setup to WE# Going High	3	40		ns
t_{DVWH}	Data Setup to WE# Going High	3	40		ns
t_{WHDX}	Data Hold from WE# High		5		ns
t_{WHAX}	Address Hold from WE# High		5		ns
t_{WHEH}	CE# Hold from WE# High		0		ns
t_{WHWL}	WE# Pulse Width High		25		ns
t_{WHRL}	WE# High to RY/BY# Going Low			90	ns
t_{WHGL}	Write Recovery before Read		0		ns
t_{QVVI}	V_{PP} Hold from Valid SRD, RY/BY# High	2,4	0		ns
t_{QVPH}	RP# V_{HH} Hold from Valid SRD, RY/BY# High	2,4	0		ns

NOTES:

1. Read timing characteristics during block erase, byte write and lock-bit configuration operations are the same as during read-only operations. Refer to AC Characteristics for read-only operations.
2. Sampled, not 100% tested.
3. Refer to Table 4 for valid A_{IN} and D_{IN} for block erase, byte write, or lock-bit configuration.
4. V_{PP} should be held at $V_{PPH1/2/3}$ (and if necessary RP# should be held at V_{HH}) until determination of block erase, byte write, or lock-bit configuration success (SR.1/3/4/5=0).
5. See Ordering Information for device speeds (valid operational combinations).

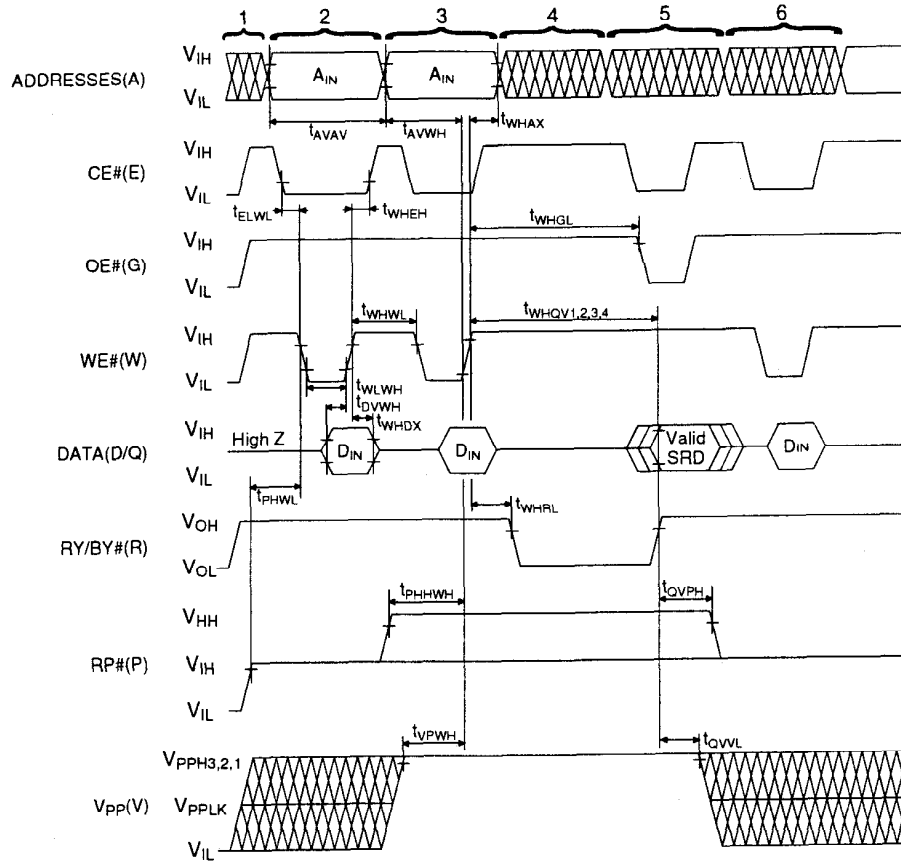

NOTES:

1. V_{CC} power-up and standby.
2. Write block erase or byte write setup.
3. Write block erase confirm or valid address and data.
4. Automated erase or program delay.
5. Read status register data.
6. Write Read Array command.

Figure 16. AC Waveform for WE#-Controlled Write Operations

6.2.6 ALTERNATIVE CE#-CONTROLLED WRITES⁽¹⁾

$V_{CC}=2.7V-3.6V, T_A=0^{\circ}C \text{ to } +70^{\circ}C$

Sym.	Parameter	Notes	Versions ⁽⁵⁾		Unit
			LH28F008SC-L170		
			Min.	Max.	
t _{AVAV}	Write Cycle Time		170		ns
t _{PHEL}	RP# High Recovery to CE# Going Low	2	1		μs
t _{WLEL}	WE# Setup to CE# Going Low		0		ns
t _{ELEH}	CE# Pulse Width		70		ns
t _{AVEH}	Address Setup to CE# Going High	3	50		ns
t _{DVEH}	Data Setup to CE# Going High	3	50		ns
t _{EHDx}	Data Hold from CE# High		5		ns
t _{EHAX}	Address Hold from CE# High		5		ns
t _{EHWH}	WE# Hold from CE# High		0		ns
t _{EHEL}	CE# Pulse Width High		25		ns
t _{EHGL}	Write Recovery before Read		0		ns

NOTE:

See 5.0V V_{CC} Alternative CE#-Controlled Writes for notes 1 through 5.

$V_{CC}=3.3V\pm 0.3V, T_A=0^{\circ}C \text{ to } +70^{\circ}C$

Sym.	Parameter	Notes	Versions ⁽⁵⁾		Unit
			LH28F008SC-L150		
			Min.	Max.	
t _{AVAV}	Write Cycle Time		150		ns
t _{PHEL}	RP# High Recovery to CE# Going Low	2	1		μs
t _{WLEL}	WE# Setup to CE# Going Low		0		ns
t _{ELEH}	CE# Pulse Width		70		ns
t _{PHHEH}	RP# V _{HH} Setup to CE# Going High	2	100		ns
t _{VPEH}	V _{PP} Setup to CE# Going High	2	100		ns
t _{AVEH}	Address Setup to CE# Going High	3	50		ns
t _{DVEH}	Data Setup to CE# Going High	3	50		ns
t _{EHDx}	Data Hold from CE# High		5		ns
t _{EHAX}	Address Hold from CE# High		5		ns
t _{EHWH}	WE# Hold from CE# High		0		ns
t _{EHEL}	CE# Pulse Width High		25		ns
t _{EHBL}	CE# High to RY/BY# Going Low			100	ns
t _{EHGL}	Write Recovery before Read		0		ns
t _{QVVL}	V _{PP} Hold from Valid SRD, RY/BY# High	2,4	0		ns
t _{OVPH}	RP# V _{HH} Hold from Valid SRD, RY/BY# High	2,4	0		ns

NOTE:

See 5V V_{CC} Alternative CE#-Controlled Writes for Notes 1 through 5.

$V_{CC}=5V\pm 0.5V, T_A=0^{\circ}C \text{ to } +70^{\circ}C$

Versions ⁽⁵⁾			LH28F008SC-L120		Unit
Sym.	Parameter	Notes	Min.	Max.	
t_{AVAV}	Write Cycle Time		120		ns
t_{PHEL}	RP# High Recovery to CE# Going Low	2	1		μs
t_{WLEL}	WE# Setup to CE# Going Low		0		ns
t_{ELEH}	CE# Pulse Width		50		ns
t_{PHEH}	RP# V_{HH} Setup to CE# Going High	2	100		ns
t_{VPEH}	V_{PP} Setup to CE# Going High	2	100		ns
t_{AVEH}	Address Setup to CE# Going High	3	40		ns
t_{DVEH}	Data Setup to CE# Going High	3	40		ns
t_{EHDH}	Data Hold from CE# High		5		ns
t_{EHAX}	Address Hold from CE# High		5		ns
t_{EHWL}	WE# Hold from CE# High		0		ns
t_{EHEL}	CE# Pulse Width High		25		ns
t_{EHRL}	CE# High to RY/BY# Going Low			90	ns
t_{EHGL}	Write Recovery before Read		0		ns
t_{OVVL}	V_{PP} Hold from Valid SRD, RY/BY# High	2,4	0		ns
t_{OVPH}	RP# V_{HH} Hold from Valid SRD, RY/BY# High	2,4	0		ns

NOTES:

1. In systems where CE# defines the write pulse width (within a longer WE# timing waveform), all setup, hold, and inactive WE# times should be measured relative to the CE# waveform.
2. Sampled, not 100% tested.
3. Refer to Table 4 for valid A_{IN} and D_{IN} for block erase, byte write, or lock-bit configuration.
4. V_{PP} should be held at $V_{PPH1/2/3}$ (and if necessary RP# should be held at V_{HH}) until determination of block erase, byte write, or lock-bit configuration success (SR.1/3/4/5=0).
5. See Ordering Information for device speeds (valid operational combinations).

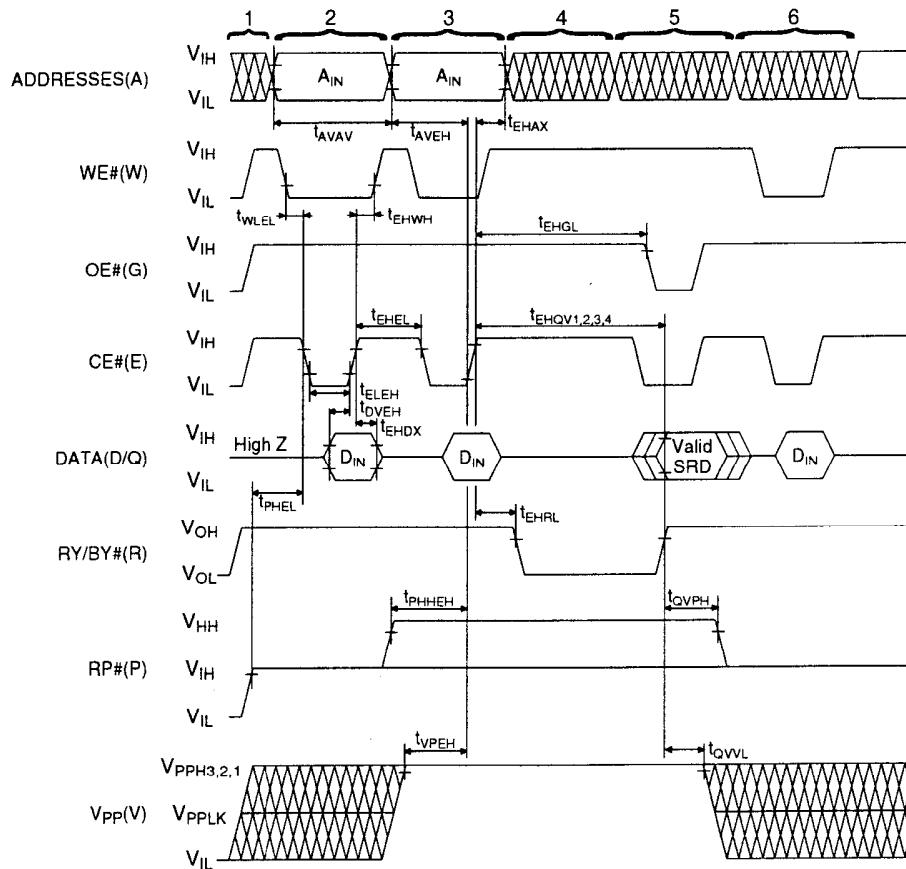

NOTES:

1. V_{CC} power-up and standby.
2. Write block erase or byte write setup.
3. Write block erase confirm or valid address and data.
4. Automated erase or program delay.
5. Read status register data.
6. Write Read Array command.

Figure 17. AC Waveform for CE#-Controlled Write Operations

6.2.7 RESET OPERATIONS

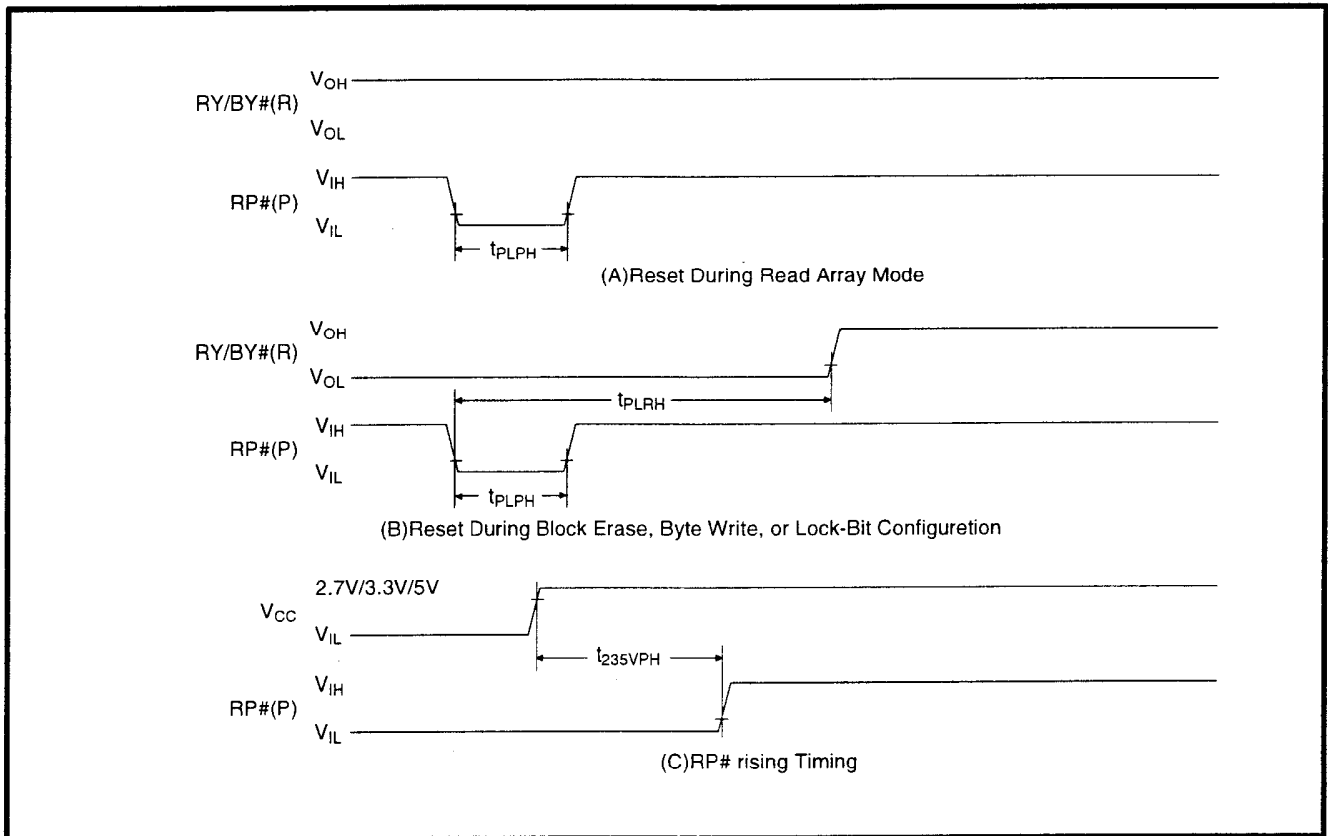

Figure 18. AC Waveform for Reset Operation

Reset AC Specifications

Sym.	Parameter	Notes	V _{CC} =2.7V		V _{CC} =3.3V		V _{CC} =5V		Unit
			Min.	Max.	Min.	Max.	Min.	Max.	
t _{PLPH}	RP# Pulse Low Time (If RP# is tied to V _{CC} , this specification is not applicable)		100		100		100		ns
t _{PLRH}	RP# Low to Reset during Block Erase, Byte Write or Lock-Bit Configuration	1,2		—		20		12	μs
t _{235VPH}	V _{CC} 2.7V to RP# High V _{CC} 3.0V to RP# High V _{CC} 4.5V to RP# High	3	100		100		100		ns

NOTES:

1. If RP# is asserted while a block erase, byte write, or lock-bit configuration operation is not executing, the reset will complete within 100ns.
2. A reset time, t_{PHQV}, is required from the latter of RY/BY# or RP# going high until outputs are valid.
3. When the device power-up, holding RP# low minimum 100ns is required after V_{CC} has been in predefined range and also has been in stable there.

6.2.8 BLOCK ERASE, BYTE WRITE AND LOCK-BIT CONFIGURATION PERFORMANCE^(3,4) $V_{CC}=3.3V\pm 0.3V$, $T_A=0^{\circ}C$ to $+70^{\circ}C$

Sym.	Parameter	Notes	$V_{PP}=3.3V$		$V_{PP}=5V$		$V_{PP}=12V$		Unit
			Typ. ⁽¹⁾	Max.	Typ. ⁽¹⁾	Max.	Typ. ⁽¹⁾	Max.	
t_{WHQV1} t_{EHQV1}	Byte Write Time	2	19	300	10	150	7	125	μs
	Block Write Time	2	1.2	4	0.7	2	0.5	1.5	s
t_{WHQV2} t_{EHQV2}	Block Erase Time	2	0.8	6	0.4	5	0.3	4	s
t_{WHQV3} t_{EHQV3}	Set Lock-Bit Time	2	21	300	13.3	150	11.6	125	μs
t_{WHQV4} t_{EHQV4}	Clear Block Lock-Bits Time	2	1.8	6	1.2	5	1.1	4	s
t_{WHRH1} t_{EHRH1}	Byte Write Suspend Latency Time to Read		7.1	10	6.6	9.3	7.4	10.4	μs
t_{WHRH2} t_{EHRH2}	Erase Suspend Latency Time to Read		15.2	21.1	12.3	17.2	12.3	17.2	μs

 $V_{CC}=5V\pm 0.5V$, $T_A=0^{\circ}C$ to $+70^{\circ}C$

Sym.	Parameter	Notes	$V_{PP}=5V$		$V_{PP}=12V$		Unit
			Typ. ⁽¹⁾	Max.	Typ. ⁽¹⁾	Max.	
t_{WHQV1} t_{EHQV1}	Byte Write Time	2	8	150	6	100	μs
	Block Write Time	2	0.5	1.5	0.4	1	s
t_{WHQV2} t_{EHQV2}	Block Erase Time	2	0.4	5	0.3	4	s
t_{WHQV3} t_{EHQV3}	Set Lock-Bit Time	2	12	150	10	100	μs
t_{WHQV4} t_{EHQV4}	Clear Block Lock-Bits Time	2	1.1	5	1	4	s
t_{WHRH1} t_{EHRH1}	Byte Write Suspend Latency Time to Read		5.6	7	5.2	7.5	μs
t_{WHRH2} t_{EHRH2}	Erase Suspend Latency Time to Read		9.4	13.1	9.8	12.6	μs

NOTES:

1. Typical values measured at $T_A=+25^{\circ}C$ and nominal voltages. Assumes corresponding lock-bits are not set. Subject to change based on device characterization.
2. Excludes system-level overhead.
3. Sampled but not 100% tested.
4. Block erase, byte write and lock-bit configuration operations with $V_{CC}<3.0V$ and/or $V_{PP}<3.0V$ are not guaranteed.

7 ADDITIONAL INFORMATION

7.1 Ordering Information

Product line designator for all SHARP Flash products

L H 2 8 F 0 0 8 S C (H) T - L 1 2

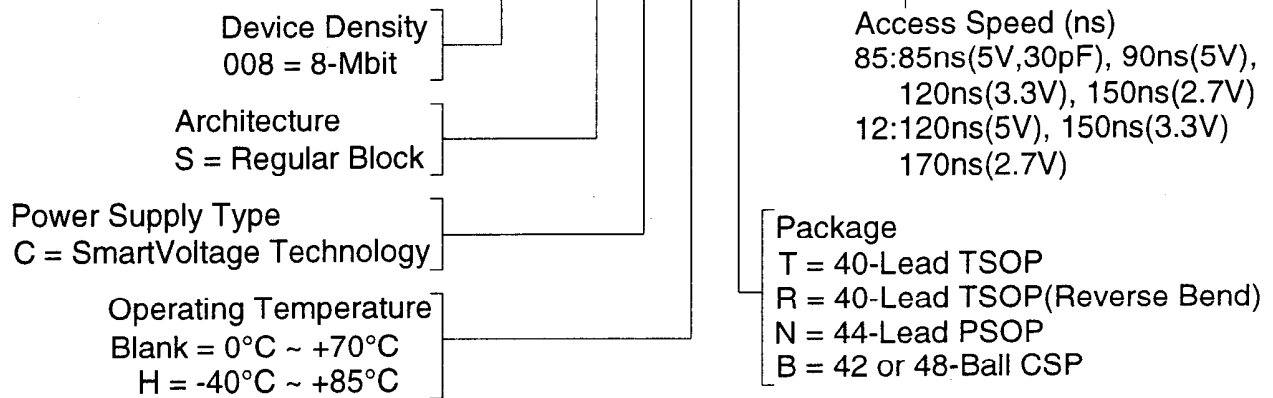

Option	Order Code	Valid Operational Combinations		
		V _{CC} =2.7-3.6V 50pF load, 1.35V I/O Levels	V _{CC} =3.3±0.3V 50pF load, 1.5V I/O Levels	V _{CC} =5.0±0.5V 100pF load, TTL I/O Levels
1	LH28F008SCT-L12	LH28F008SC-L170	LH28F008SC-L150	LH28F008SC-L120

8 Package and packing specification

1. Package Outline Specification

Refer to drawing No. AA1105

2. Markings

2-1. Marking contents

(1) Product name : LH28F008SCT-L12

(2) Company name : SHARP

(3) Date code

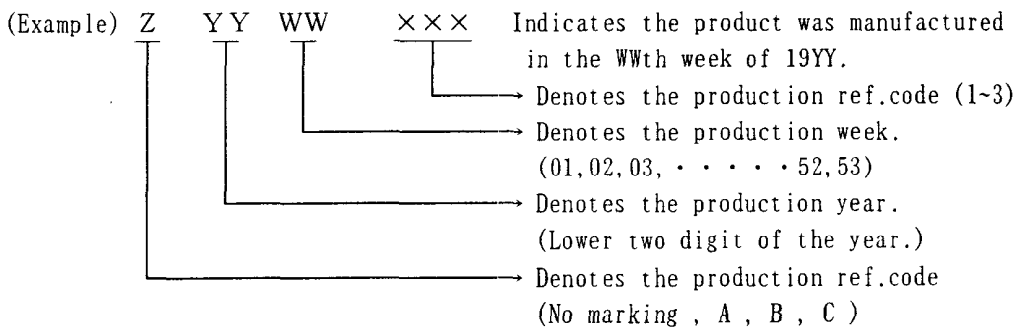

(4) "JAPAN" is marked on the package when both wafer and assembly processes are done in Japan , indicating the country of origin.

2-2. Marking layout

Refer drawing No. AA1105

(This layout does not define the dimensions of marking character and marking position.)

3. Packing Specification (Dry packing for surface mount packages)

Dry packing is used for the purpose of maintaining IC quality after mounting packages on the PCB (Printed Circuit Board).

When the epoxy resin which is used for plastic packages is stored at high humidity, it may absorb 0.15% or more of its weight in moisture. If the surface mount type package for a relatively large chip absorbs a large amount of moisture between the epoxy resin and insert material (e.g. chip, lead frame) this moisture may suddenly vaporize into steam when the entire package is heated during the soldering process (e.g. VPS). This causes expansion and results in separation between the resin and insert material, and sometimes cracking of the package. This dry packing is designed to prevent the above problem from occurring in surface mount packages.

3-1. Packing Materials

Material Name	Material Specificaiton	Purpose
Tray	Conductive plastic (50devices/tray)	Fixing of device
Upper cover tray	Conductive plastic (1tray/case)	Fixing of device
Laminated aluminum bag	Aluminum polyethylene (1bag/case)	Drying of device
Desiccant	Silica gel	Drying of device
P P band	Polypropylene (3pcs/case)	Fixing of tray
Inner case	Card board (500devices/case)	Packaging of device
Label	Paper	Indicates part number, quantity and date of manufacture
Outer case	Card board	Outer packing of tray

(Devices shall be placed into a tray in the same direction.)

3-2. Outline dimension of tray

Refer to attached drawing

4. Storage and Opening of Dry Packing

4-1. Store under conditions shown below before opening the dry packing

- (1) Temperature range : 5~40°C
- (2) Humidity : 80% RH or less

4-2. Notes on opening the dry packing

- (1) Before opening the dry packing, prepare a working table which is grounded against ESD and use a grounding strap.
- (2) The tray has been treated to be conductive or anti-static. If the device is transferred to another tray, use a equivalent tray.

4-3. Storage after opening the dry packing

Perform the following to prevent absorption of moisture after opening.

- (1) After opening the dry packing, store the ICs in an environment with a temperature of 5~25°C and a relative humidity of 60% or less and mount ICs within 72 hours after opening dry packing.

4-4. Baking (drying) before mounting

- (1) Baking is necessary
 - (A) If the humidity indicator in the desiccant becomes pink
 - (B) If the procedure in section 4-3 could not be performed
- (2) Recommended baking conditions

If the above conditions (A) and (B) are applicable, bake it before mounting. The recommended conditions are 16~24 hours at 120°C.

Heat resistance tray is used for shipping tray.

5. Surface Mount Conditions

Please perform the following conditions when mounting ICs not to deteriorate IC quality.

5-1. Soldering conditions (The following conditions are valid only for one time soldering.)

Mounting Method	Temperature and Duration	Measurement Point
Reflow soldering (air)	Peak temperature of 230°C or less, duration of less than 15 seconds. 200°C or over, duration of less than 40 seconds. Temperature increase rate of 1~4°C/second	IC package surface
Manual soldering (soldering iron)	260°C or less, duration of less than 10 seconds.	IC outer lead surface

5-2. Conditions for removal of residual flux

- (1) Ultrasonic washing power : 25 Watts/liter or less
- (2) Washing time : Total 1 minute maximum
- (3) Solvent temperature : 15~40°C

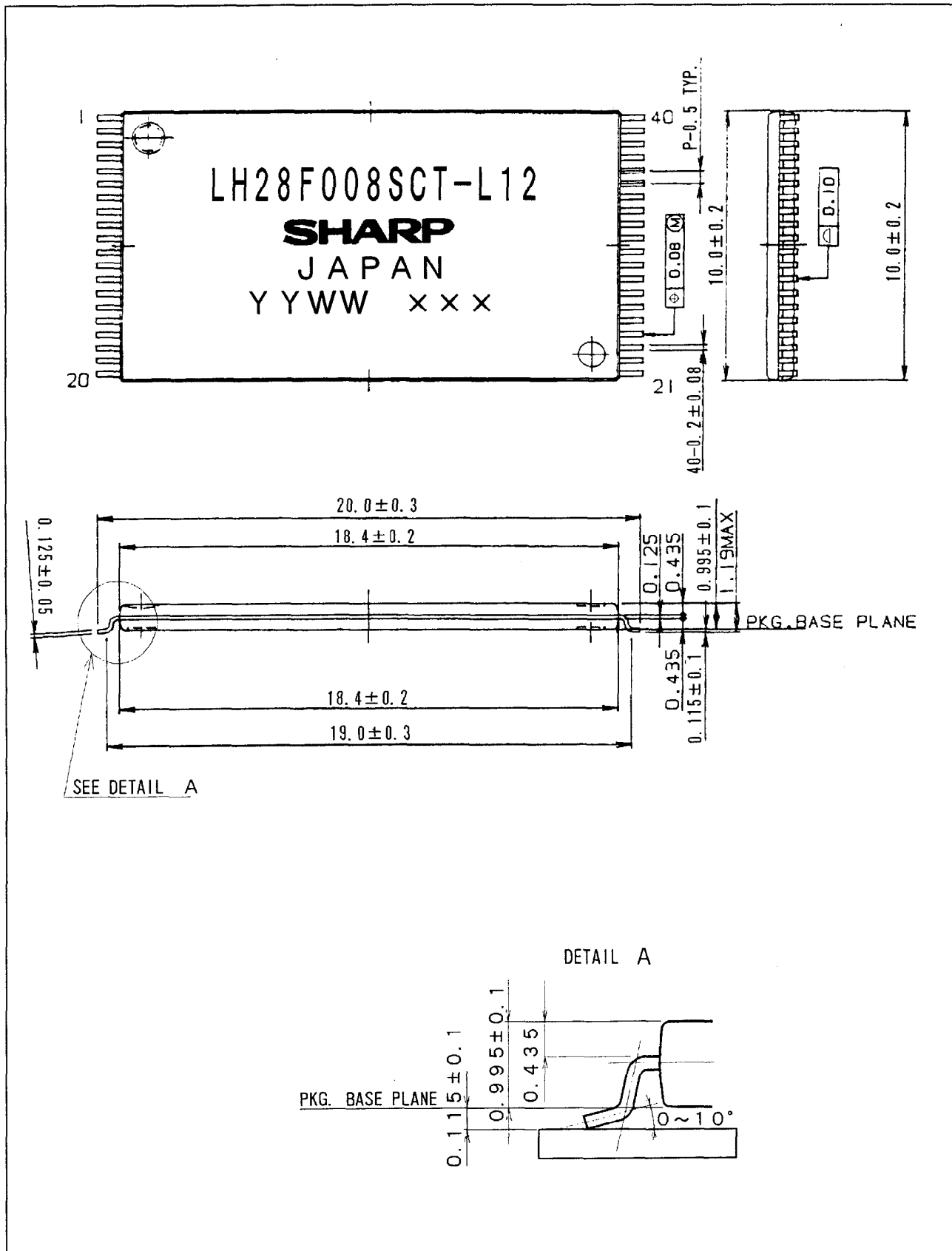

注記 : 『JAPAN』表記がある場合のマーク仕様
 NOTES : Marking specification when "JAPAN" is marked.

名称	リード仕上	TIN-LEAD	備考
NAME	LEAD FINISH	PLATING	プラスチックパッケージ外形寸法は、バリを含まないものとする。
DRAWING NO.	単位	UNIT	NOTE Plastic body dimensions do not include burr of resin.
AA1105	mm	mm	

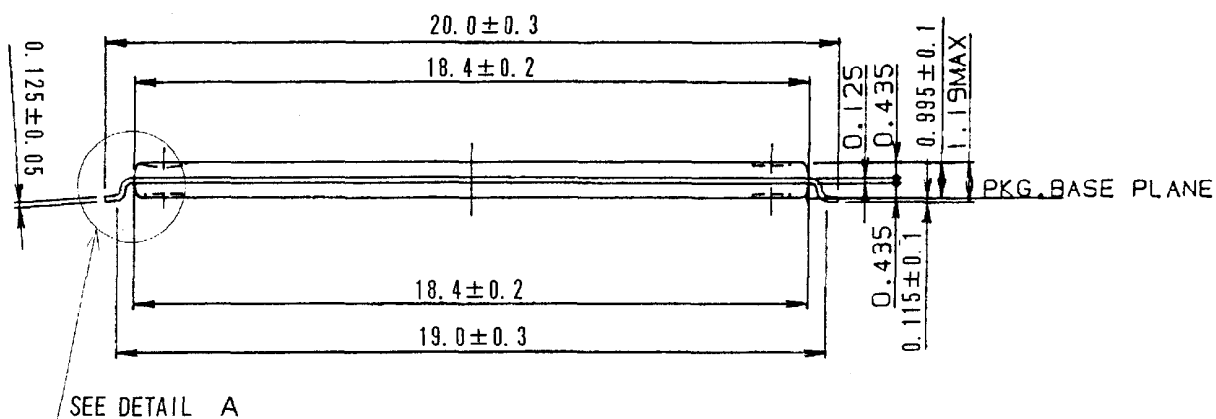
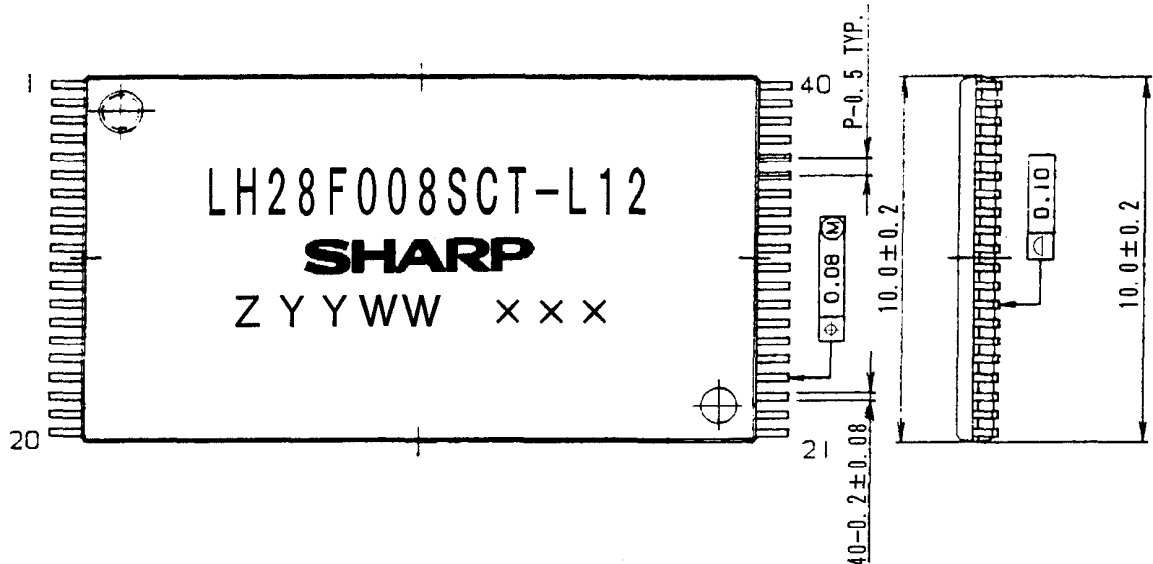

DETAIL A

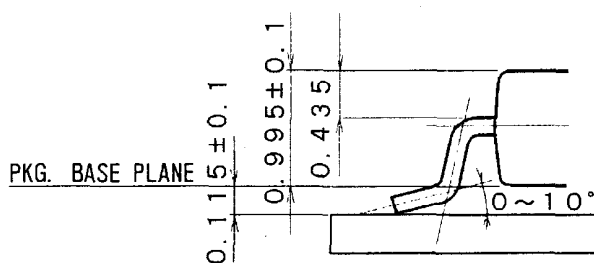

注記 : 『JAPAN』表記がない場合のマーク仕様
 NOTES : Marking specification when "JAPAN" is not marked.

名称 NAME	リード仕上 LEAD FINISH	TIN-LEAD PLATING	備考 NOTE
TSOP40-P-1020			プラスチックパッケージ外形寸法は、バリを含まないものとする。 Plastic body dimensions do not include burr of resin.
DRAWING NO.	単位 UNIT		
AA1105	mm		

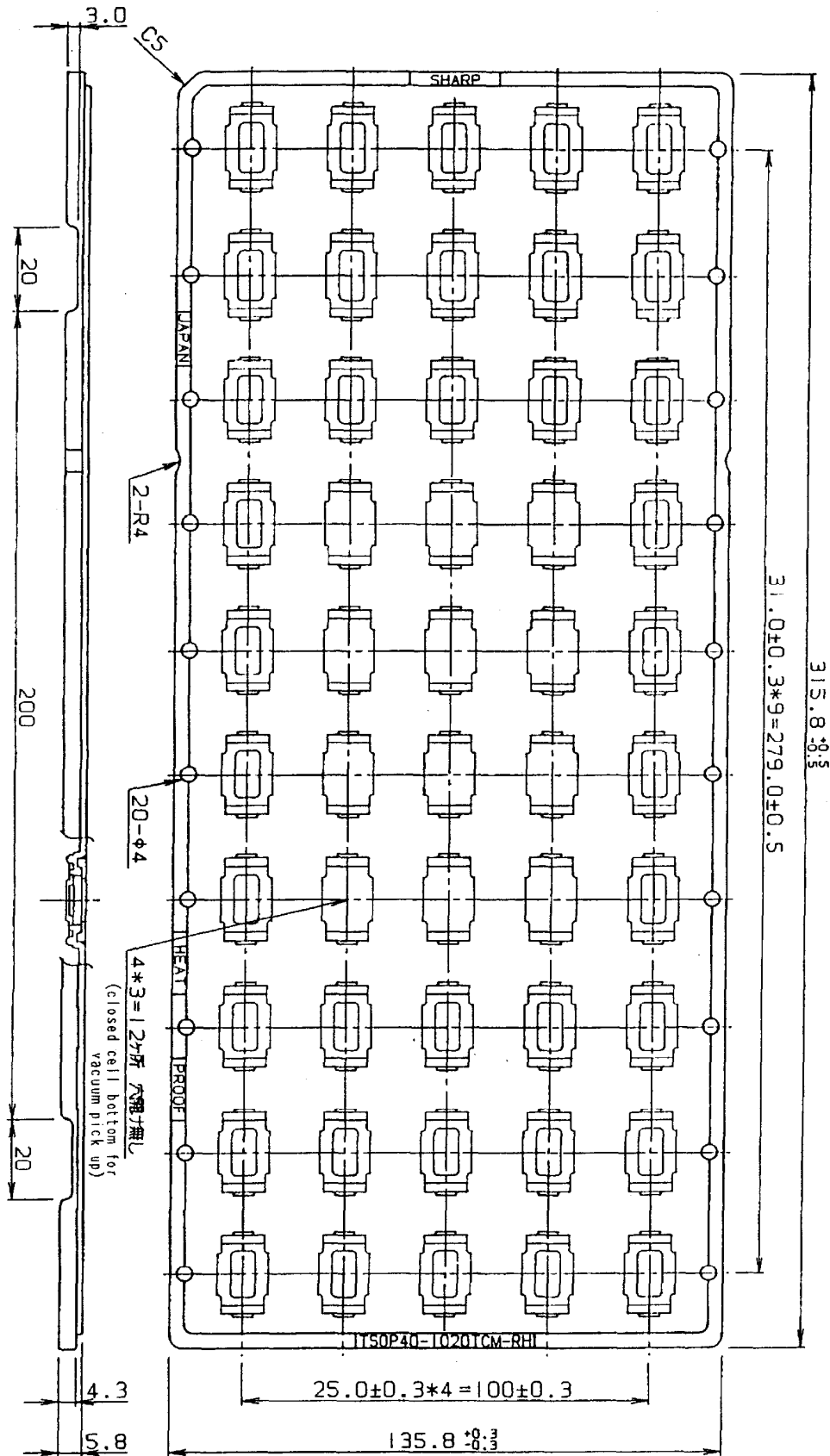

名称	TSOP40-1020TCM-RH	
NAME	TSOP40-1020TCM-RH	
DRAWING NO.	CV644	UNIT mm

備考	NOTE
単位	
UNIT	mm

《Supplementary data》

LHF08CH3	
Recommended mounting conditions for two time reflow soldering .	
Product name(Package)	LH28F008SCT-L12(TSOP40-P-1020)
Packing specification	Tray (Dry packing)
Mounting method	Reflow soldering (Air)
Reflow soldering conditions	Peak temperature of 230°C or less. 200°C or over, duration of less than 40 seconds. Preheat temperature of 125~150°C, duration of less than 180 seconds. Temperature increase rate of 1~4°C/second.
Measurement point	IC package surface
Storage conditions	After opening the dry packing, store the ICs in an environment with a temperature of 5~25°C and a relative humidity of 60% or less. If doing reflow soldering twice, do the first reflow soldering within 72 hours after opening dry packing and do the second reflow soldering within 72 hours after the first reflow soldering.
Note	If the above storage conditions are not applicable, bake it before reflow soldering. The recommended conditions are 16~24 hours at 120°C. (Heat resistance tray is used for shipping tray.)

Recommended Reflow Soldering(Air) Temperature Profile

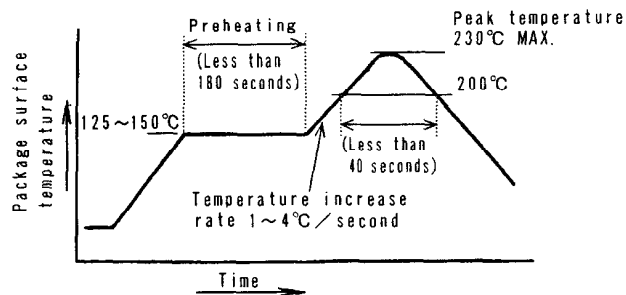

(NO. 990414-X11)

Flash memory LHFXXCXX family Data Protection

Noises having a level exceeding the limit specified in the specification may be generated under specific operating conditions on some systems.

Such noises, when induced onto WE# signal or power supply, may be interpreted as false commands, causing undesired memory updating.

To protect the data stored in the flash memory against unwanted overwriting, systems operating with the flash memory should have the following write protect designs, as appropriate:

1) Protecting data in specific block

When a lock bit is set, the corresponding block is protected against overwriting. By using this feature, the flash memory space can be divided into the program section (locked section) and data section (unlocked section). The master lock bit can be used to prevent false block bit setting.

By controlling RP#, desired blocks can be locked/unlocked through the software.

For further information on setting/resetting block bit and controlling of RP#, refer to the specification. (See chapter 4.9 and 4.10)

2) Data protection through Vpp

When the level of Vpp is lower than VPPLK (lockout voltage), write operation on the flash memory is disabled. All blocks are locked and the data in the blocks are completely write protected.

For the lockout voltage, refer to the specification. (See chapter 6.2.3.)

3) Data protection through RP#

When the RP# is kept low during power up and power down sequence such as voltage transition, write operation on the flash memory is disabled, write protecting all blocks.

For the details of RP# control, refer to the specification. (See chapter 5.6 and 6.2.7.)