



# STV9380A

## Class-D Vertical Deflection Amplifier for 2.5 Amp TV and Monitor Applications

### Main Features

- High-Efficiency Power Amplifier
- No Heatsink
- Split Supply
- Internal Flyback Generator
- Output Current up to 2.5 A<sub>PP</sub>
- Suitable for DC Coupling Applications
- Few External Components
- Protection against Low V<sub>CC</sub>

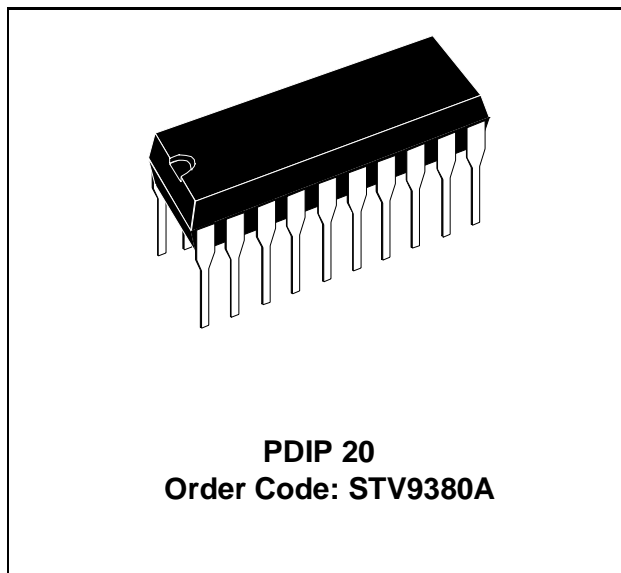

### Description

Designed for TV and monitor applications, the STV9380A is a Class-D vertical deflection booster assembled in a 20-pin plastic DIP package.

It operates with supplies up to  $\pm 18$  V and provides an output current up to 2.5 A<sub>PP</sub> to drive the yoke. The internal flyback generator avoids the need for an extra power supply.

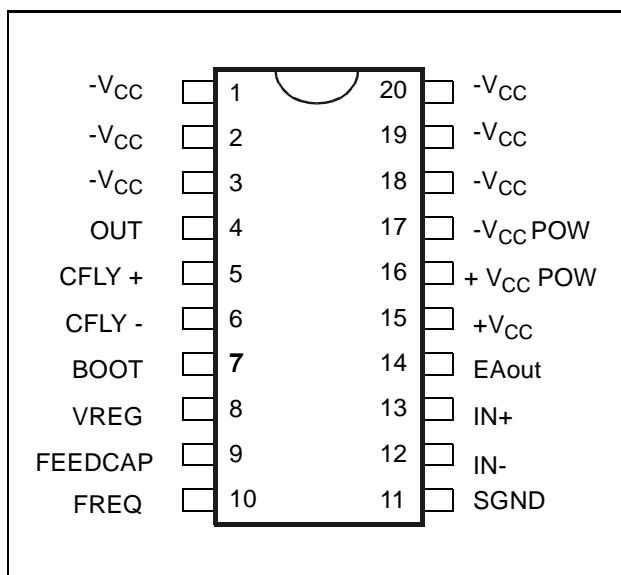

# 1 Pin Functions

Table 1: STV9380A Pin Descriptions

Pin	Name	Function	Pin	Name	Function
1	-V <sub>CC</sub>	Negative Supply	11	SGND	Signal Ground
2	-V <sub>CC</sub>	Negative Supply	12	IN-	Error Amplifier Inverting Input
3	-V <sub>CC</sub>	Negative Supply	13	IN+	Error Amplifier Non-inverting Input
4	OUT	PWM Output	14	EA out	Error Amplifier Output
5	CFLY+	Flyback Capacitor	15	+V <sub>CC</sub>	Positive Supply
6	CFLY-	Flyback Capacitor	16	+V <sub>CC</sub> POW	Positive Power Supply
7	BOOT	Bootstrap Capacitor	17	-V <sub>CC</sub> POW	Negative Power Supply
8	VREG	Internal Voltage Regulator	18	-V <sub>CC</sub>	Negative Supply
9	FEEDCAP	Feed-back Integrating Capacitor	19	-V <sub>CC</sub>	Negative Supply
10	FREQ	Frequency Setting Resistor	20	-V <sub>CC</sub>	Negative Supply

Note 1. The voltage reference, accessible on pin 8, is for internal use only. No additional components should be connected to this pin except the decoupling capacitor.

## 2 Functional Description

The STV9380A is a vertical deflection circuit operating in Class D. Class D is a modulation method where the output transistors work in switching mode at high frequency. The output signal is restored by filtering the output square wave with an external LC filter. The major interest of this IC is the comparatively low power dissipation in regards to traditional amplifiers operating in class AB, eliminating the need of an heatsink.

Except for the output stage which uses Class D modulation, the circuit operation is similar to the one of a traditional linear vertical amplifier.

A (sawtooth) reference signal has to be applied to the circuit which can accept a differential or single ended signal. This sawtooth is amplified and applied as a current to the deflection yoke. This current is measured by means of a low value resistor. The resulting voltage is used as a feedback signal to guarantee the conformity of the yoke current with the reference input signal.

The overvoltage necessary for a fast retrace is obtained with a chemical capacitor charged at the power supply voltage of the circuit. At the flyback moment, this capacitor is connected in series with the output stage power supply. This method, used for several years with the linear vertical boosters and called "internal flyback" or "flyback generator", avoids the need of an additional power supply, while reducing the flyback duration.

The circuit uses a BCD process that combines Bipolar, CMOS and DMOS devices. The output stage is composed of low-R<sub>ON</sub> N-channel DMOS transistors.

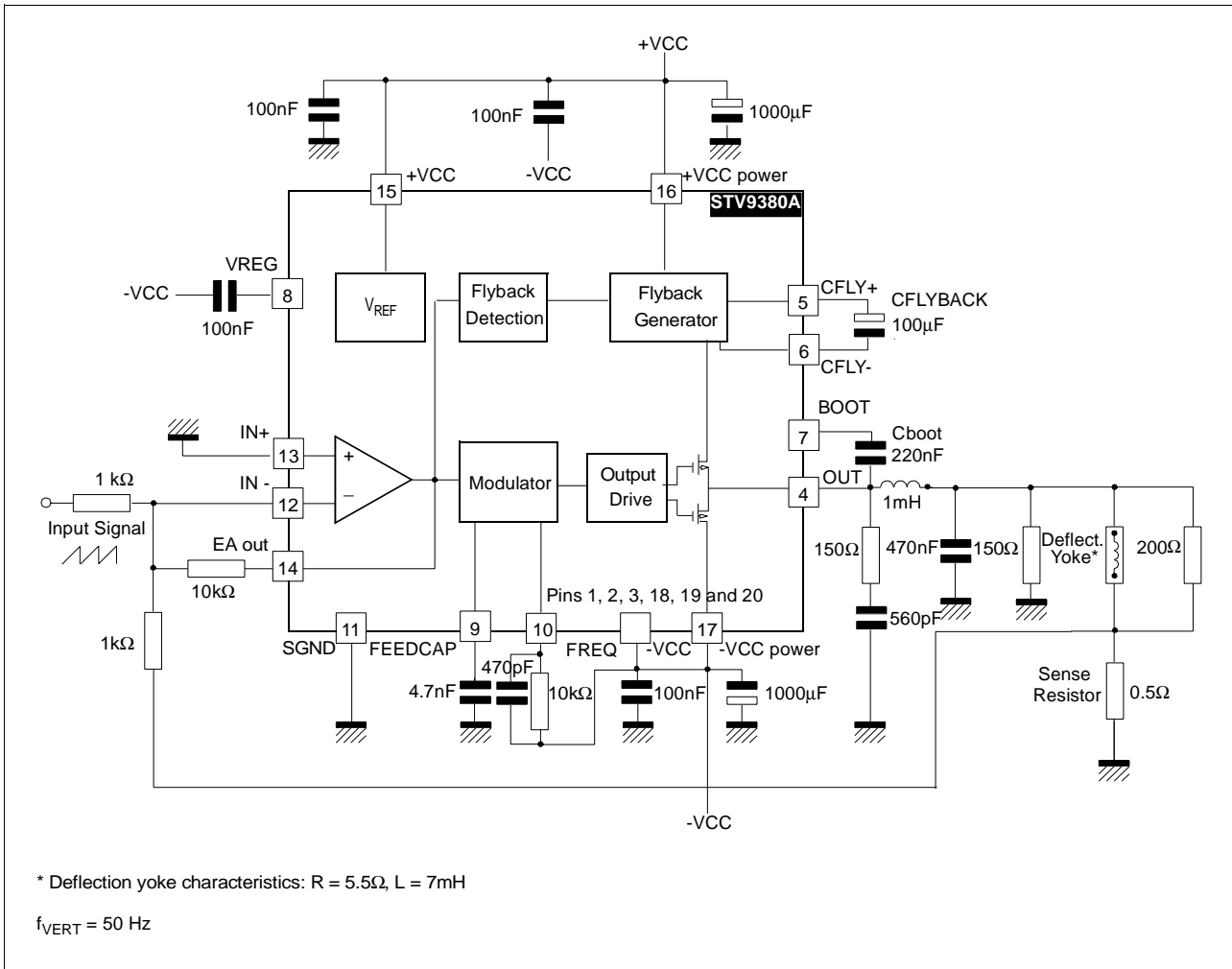
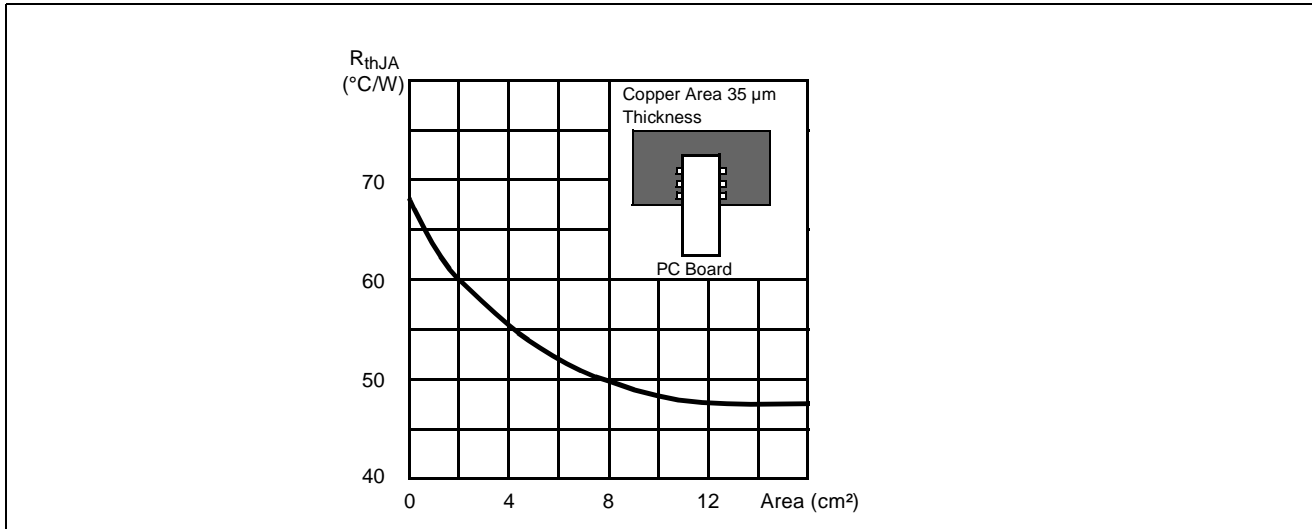

Figure 1: Test and Application Circuit Diagram

Figure 2: Thermal Resistance with “On-board” Square Heatsink vs. Copper Area



### 3 Absolute Maximum Ratings

Symbol	Parameter	Value	Unit
V <sub>CC</sub>	DC Supply Voltage	±20	V
T <sub>STG</sub> , T <sub>J</sub>	Storage and Junction Temperature	-40 to +150	°C
T <sub>OP</sub>	Operating Temperature Range	-20 to +70	°C
V <sub>ESD</sub>	ESD Susceptibility - Human Body Model (100 pF discharge through 1.5 kΩ)	±2	kV
I <sub>OUT</sub>	Output current	±1.6	A
V <sub>OUT</sub>	Maximum output voltage (pin 4) with respect to -V <sub>CC</sub> (pins 1, 2, 3, 18, 19 and 20) and during flyback (see Note 1)	80	V

Note 1. During the flyback with V<sub>CC</sub> = ±18 V, the maximum output voltage (pin 4) is close to 72 V, with respect to -V<sub>CC</sub> (pins 1, 2, 3, 18, 19 and 20).

### 4 Thermal Data

Symbol	Parameter	Value	Unit
R <sub>thJA</sub>	Junction-to-Ambient Thermal Resistance	70	°C/W

Pins 1, 2, 3, 18, 19 and 20 are internally connected together and participate in heat evacuation.

## 5 Electrical Characteristics

$T_{AMB} = 25^{\circ} \text{C}$ ,  $V_{CC} = \pm 12 \text{V}$  and  $f_{VERT} = 50 \text{Hz}$  unless otherwise specified (refer to Figure 1)

Symbol	Parameter	Test Conditions	Min.	Typ.	Max.	Units
+V <sub>CC</sub>	Positive Supply Range		+10		+18	V
-V <sub>CC</sub>	Negative Supply Range		-18		-10	V
$\Delta V_{CC}$	Maximum recommended difference between +V <sub>CC</sub> and  -V <sub>CC</sub>				$\pm 4$	V
V <sub>CCSTART</sub>	Low V <sub>CC</sub> Detection			$\pm 6.5$		V
I <sub>Q</sub>	Quiescent Supply Current	Input Voltage = 0		14		mA
I <sub>Y</sub>	Maximum Vertical Yoke Current				$\pm 1.25$	A
I <sub>13</sub> , I <sub>12</sub>	Amplifier Input Bias Current			-0.1		$\mu\text{A}$
V <sub>OS</sub>	Output Offset Voltage	Note 1	-50		+50	mV
SVR	Supply Voltage Rejection	Note 2		82		dB
Fly <sub>THR</sub>	Flyback Detection Threshold (Positive Slope)	V(14)		1.5		V
Fly <sub>THF</sub>	Flyback Detection Threshold (Negative Slope)	V(14)		0.5		V
P <sub>D</sub>	Integrated Circuit Dissipated Power	Note 3		1.1		W
f <sub>SW</sub>	Switching Frequency	R <sub>FREQ</sub> = 10 k $\Omega$	120	140	160	kHz
f <sub>SW-OP</sub>	Switching Frequency Operative Range		100		200	kHz
R <sub>FREQ</sub>	Frequency Controller Resistor Range	Pin 10	7	10	14	k $\Omega$

Note 1. Input voltage = 0, measured after the filter (e.g. across the 470 nF filter capacitor)

- Supply rejection of the positive or negative power supply. V<sub>CC</sub> ripple = 1 V<sub>PP</sub>, f = 100 Hz, measured on the sense resistor.
- Power dissipated in the circuit in the case of the application from Figure 1 and the current in the deflection yoke adjusted to 2.5 A<sub>PP</sub>. The corresponding power dissipated in the vertical deflection yoke is 2.8 W.

## 6 I/O Waveforms

The following waveforms are obtained with the schematic diagram given in Figure 1: Test and Application Circuit Diagram.

**Figure 3: Current in the Deflection Yoke (Calibration: 0.5 A/div.)**

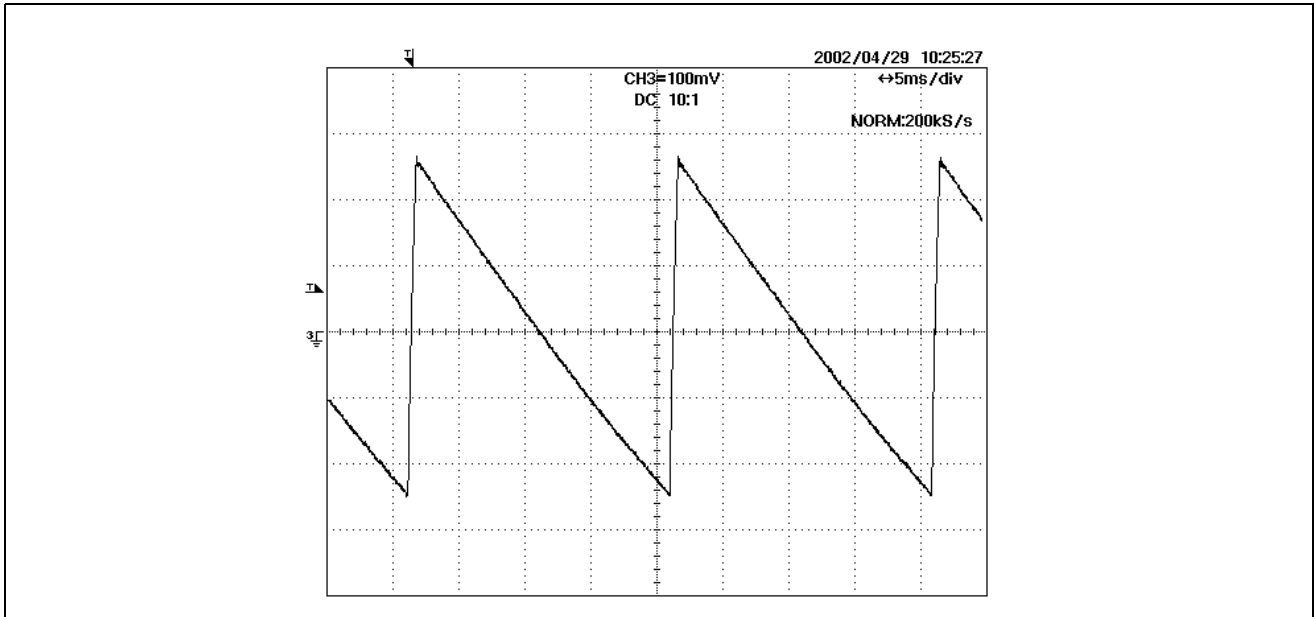

**Figure 4: Current and Voltage in the Deflection Yoke during Flyback (Calibration: 0.5A/div, 10 V/div)**

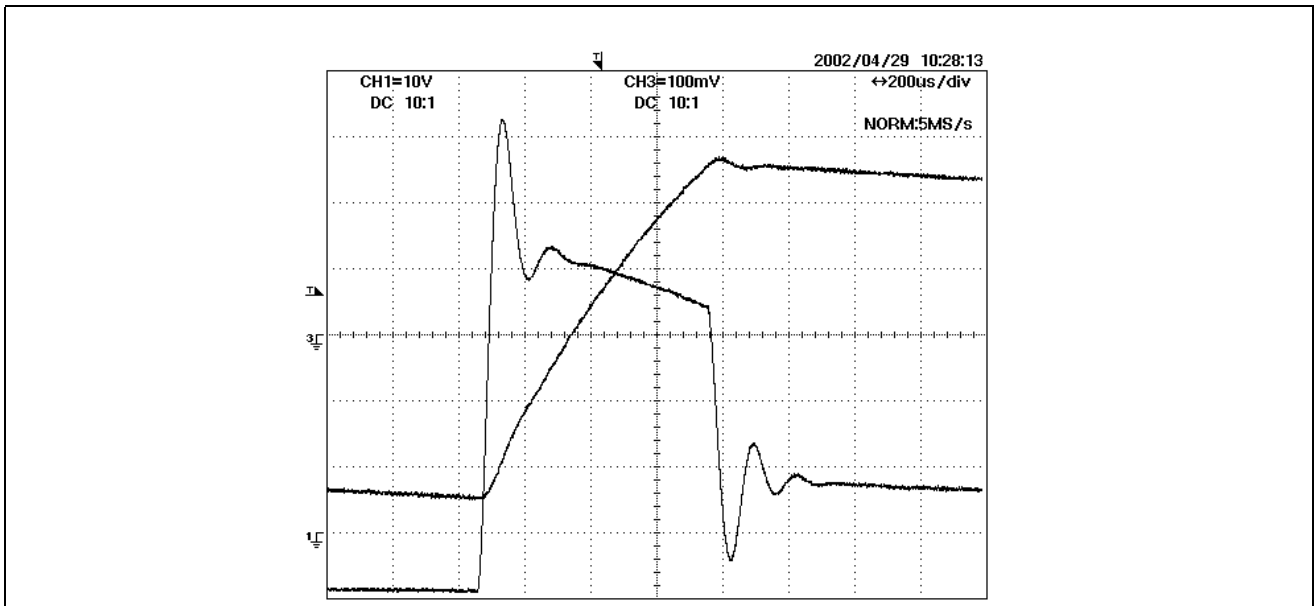

Figure 5: Current in the Deflection Yoke and Voltage at the Error Amplifier Output (pin 14 - STV9380A) during Flyback (Calibration: 0.5 A/div, 1 V/div)

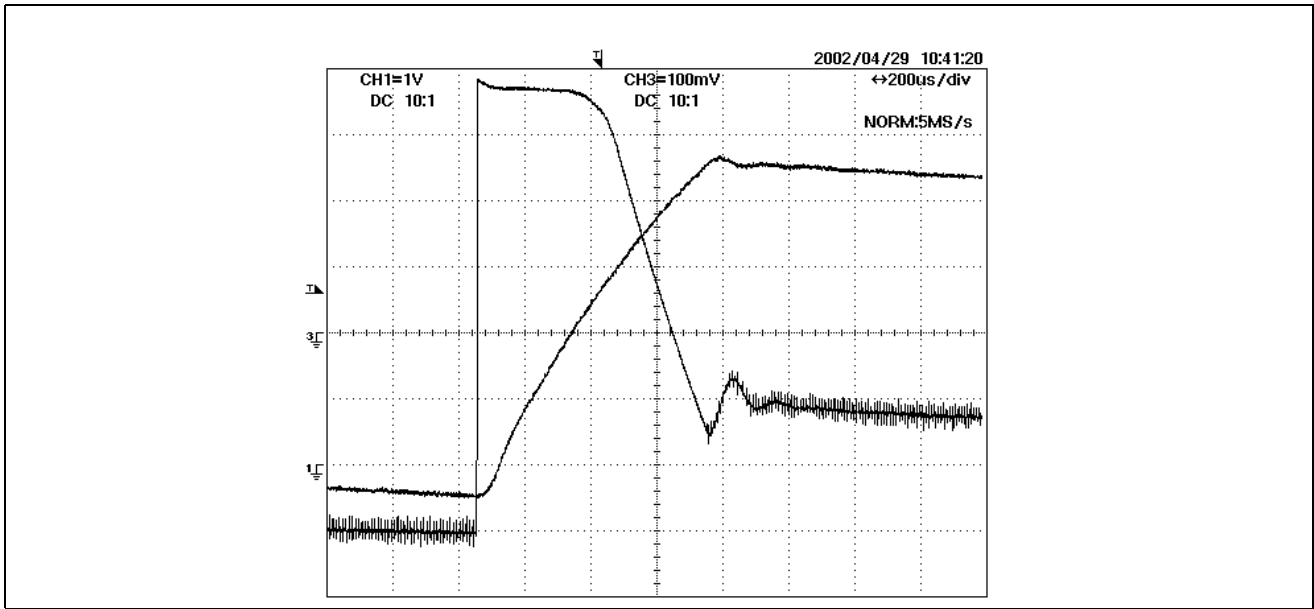
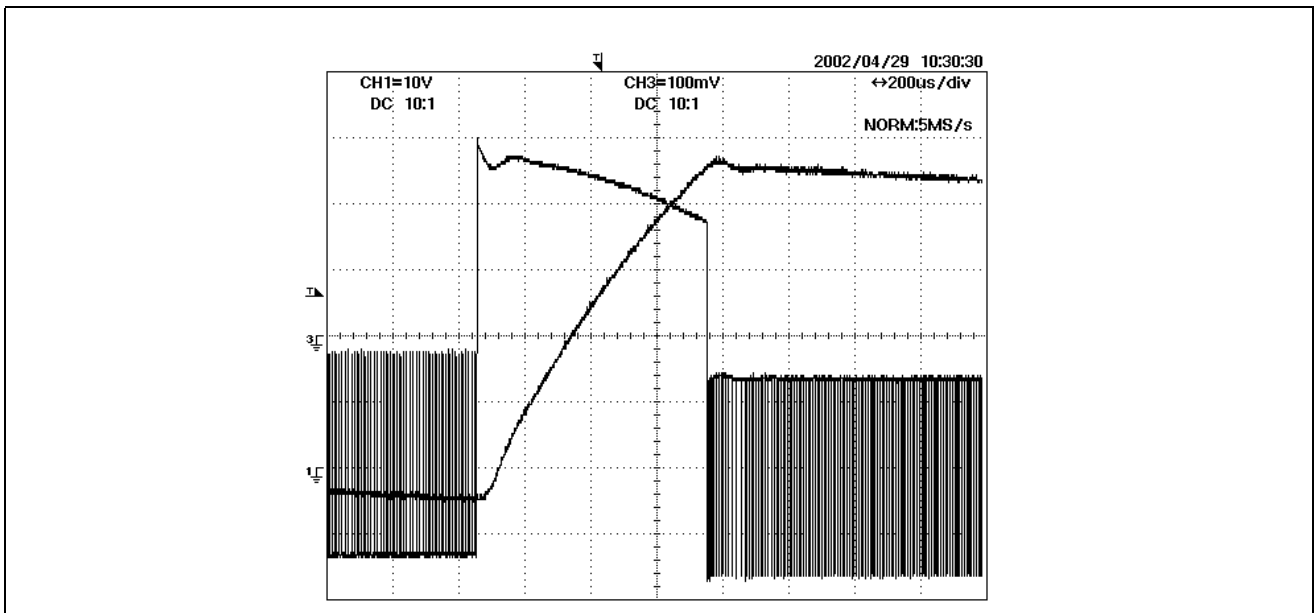

Figure 6: Current in the Deflection Yoke and Voltage at the Output of the STV9380A (pin 4), during the Flyback (Calibration: 0.5 A/div, 10 V/div)



# 7 Package Mechanical Data

Figure 7: 20-Pin Plastic Dual In-Line Package, 300-mil Width

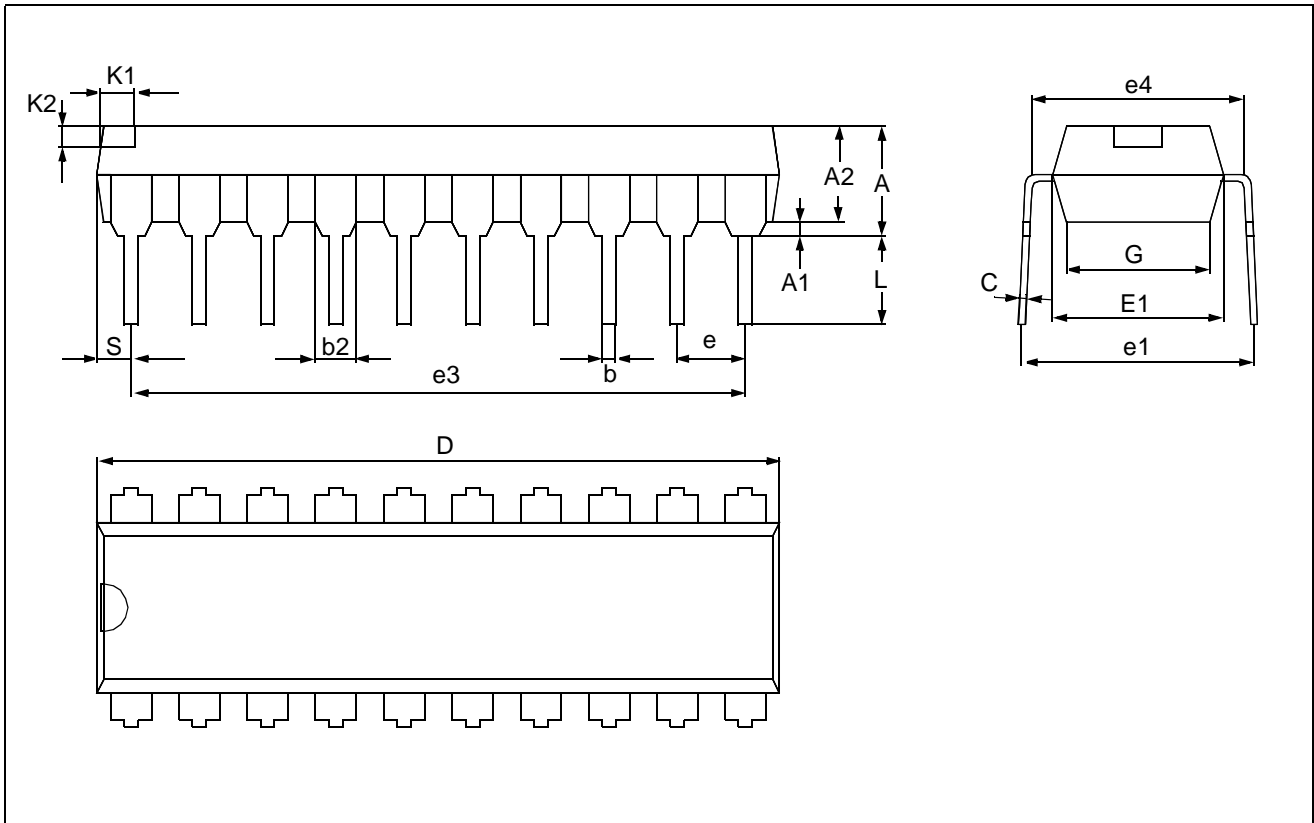
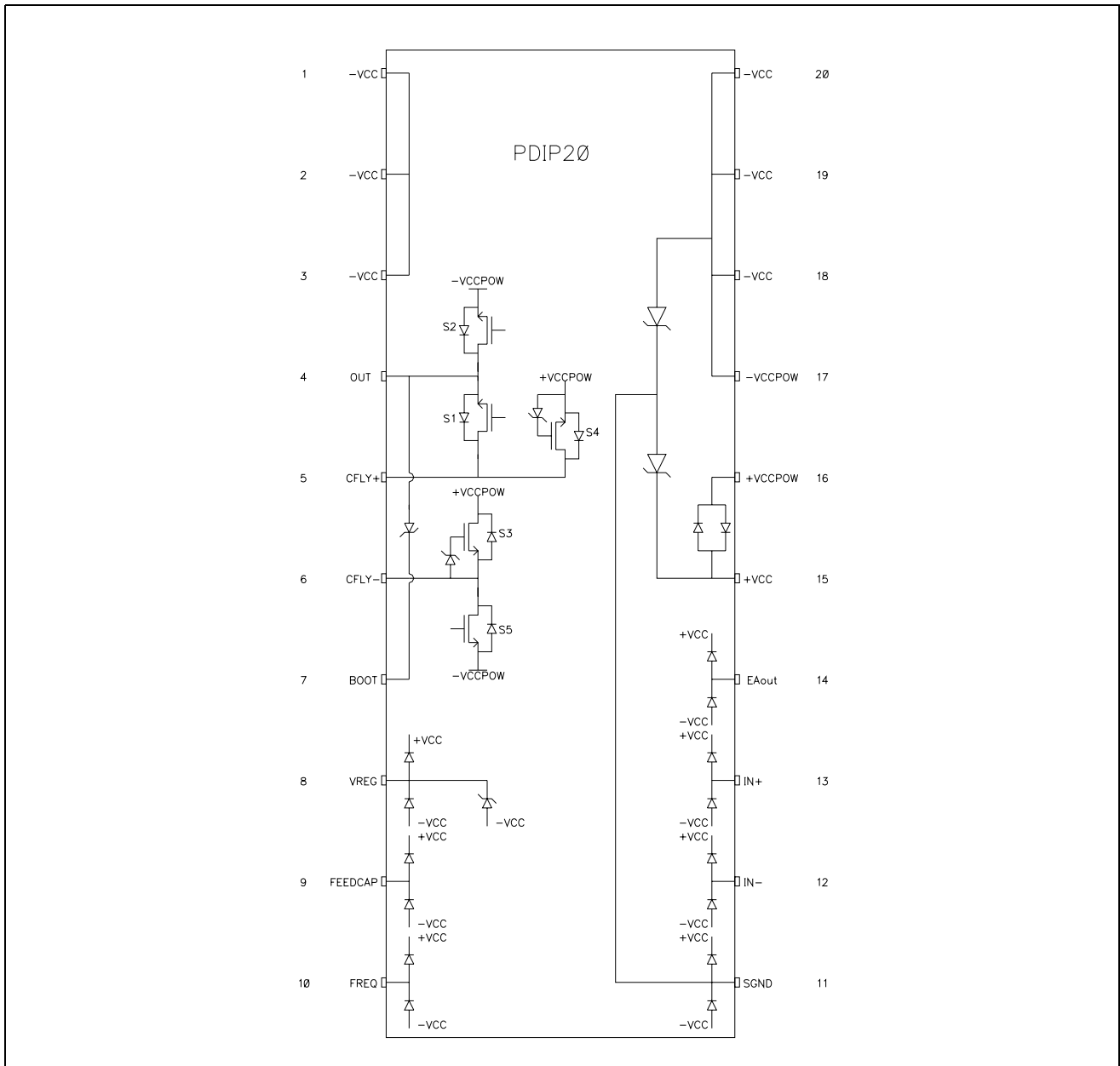

Table 2: DIP20 Package

Dim.	mm			inches		
	Min.	Typ.	Max.	Min.	Typ.	Max.
A			5.33			0.210
A1	0.38			0.015		
A2	2.92	3.30	4.95	0.115	0.130	0.195
b	0.36	0.46	0.56	0.014	0.018	0.022
b2	1.14	1.52	1.78	0.045	0.060	0.070
c	0.20	0.25	0.36	0.008	0.010	0.014
D	24.89		26.92	0.980		1.060
e		2.54			0.100	
E1	6.10	6.35	7.11	0.240	0.250	0.280
L	2.92	3.30	3.81	0.115	0.130	0.150
	Number of Pins					
N	20					



Figure 8: ESD Protection Structure



## 8 Revision History

**Table 3: Summary of Modifications**

Version	Date	Description
1.0	May 2003	First Issue

Information furnished is believed to be accurate and reliable. However, STMicroelectronics assumes no responsibility for the consequences of use of such information nor for any infringement of patents or other rights of third parties which may result from its use. No license is granted by implication or otherwise under any patent or patent rights of STMicroelectronics. Specifications mentioned in this publication are subject to change without notice. This publication supersedes and replaces all information previously supplied. STMicroelectronics products are not authorized for use as critical components in life support devices or systems without express written approval of STMicroelectronics.

The ST logo is a registered trademark of STMicroelectronics

© 2003 STMicroelectronics - All Rights Reserved

STMicroelectronics GROUP OF COMPANIES

Australia - Brazil - Canada - China - Finland - France - Germany - Hong Kong - India - Israel - Italy - Japan  
Malaysia - Malta - Morocco - Singapore - Spain - Sweden - Switzerland - United Kingdom - U.S.A.

[www.st.com](http://www.st.com)