

MITSUBISHI LSIs M5L27128K, -2

**131 072-BIT (16384-WORD BY 8-BIT)
ERASABLE AND ELECTRICALLY REPROGRAMMABLE ROM**

DESCRIPTION

The Mitsubishi M5L27128K is a high-speed 131072-bit ultraviolet erasable and electrically reprogrammable read only memory. It is suitable for microprocessor programming applications where rapid turn-around is required. The M5L27128K is fabricated by N-channel double polysilicon gate technology and is available in a 28-pin DIL package with a transparent lid.

FEATURES

- 16384 word x 8 bit organization
- Access time M5L27128K-2 200ns (max.)
M5L27128K 250ns (max.)
- Two line control \overline{OE} , \overline{CE}
- Low power current (I_{CC}): Active 100mA (max.)
Standby 45mA (max.)
- Single 5V power supply
- 3-State output buffer
- Input and output TTL-compatible in read and program mode
- Standard 28-pin DIL package
- Fast programming algorithm
- Interchangeable with INTEL 27128

APPLICATION

- Microcomputer systems and peripheral equipment

PIN CONFIGURATION (TOP VIEW)

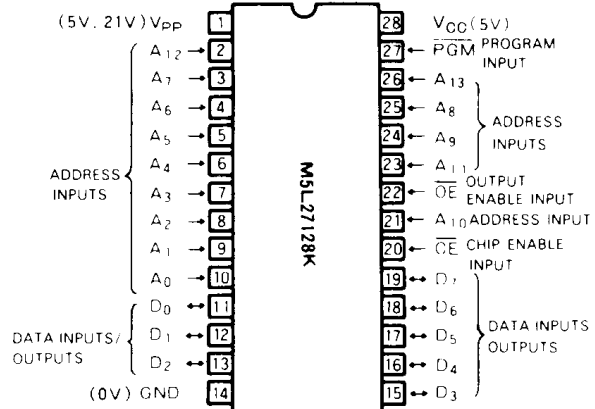

Outline 28K4

BLOCK DIAGRAM

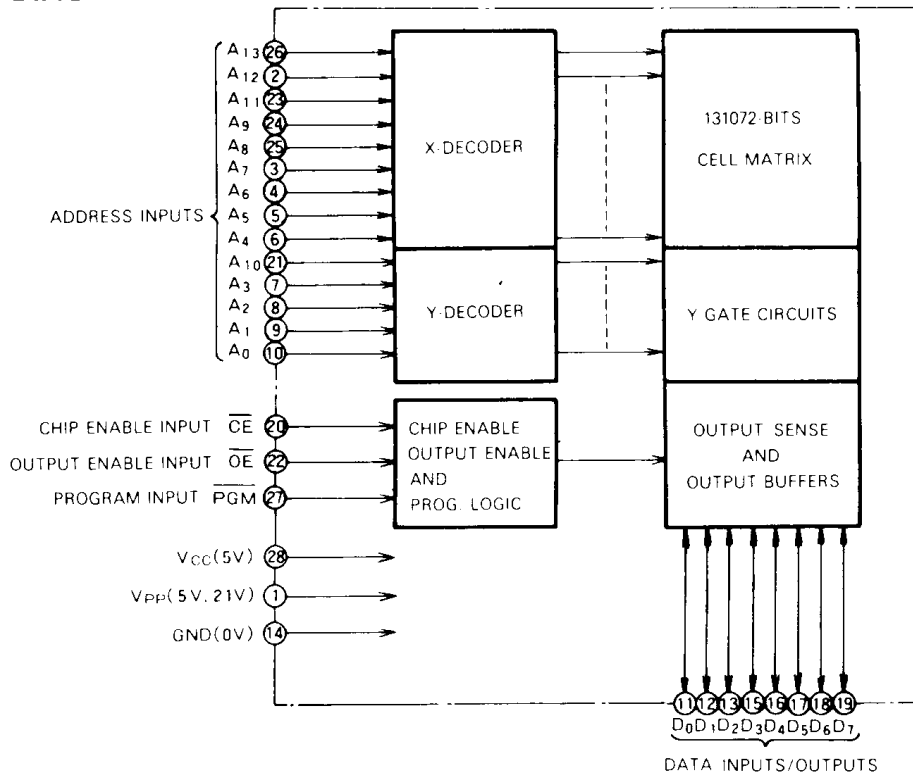

**131 072-BIT(16384-WORD BY 8-BIT)
 ERASABLE AND ELECTRICALLY REPROGRAMMABLE ROM**

FUNCTION

Read

Set the \overline{CE} and \overline{OE} terminals to the read mode (low level). Low level input to \overline{CE} and \overline{OE} and address signals to the address inputs ($A_0 \sim A_{13}$) make the data contents of the designated address location available at the data input/output ($D_0 \sim D_7$). When the \overline{CE} or \overline{OE} signal is high, data input/output are in a floating state.

When the \overline{CE} signal is high, the device is in the standby mode or power-down mode.

Programming

(Fast programming algorithm)

First set $V_{CC} = 6V$, $V_{PP} = 21V$ and then set an address to first address to be programmed. After applying 1 ms program pulse (\overline{PGM}) to the address, verify is performed. If the output data of that address is not verified correctly, apply one more 1 ms program pulse. The programmer continues 1 ms pulse-then-verify routines until the device verify correctly or fifteen of these pulse-then-verify routines have been completed. The programmer also maintains its total number of 1 ms pulses applied to that address in register X. And then applied a program pulse 4 times of register X value long as an overprogram pulse. When the programming procedure above is finished, step to the next address and repeat this procedure till last address to be programmed. (See P.6-15)

(Conventional programming algorithm)

The device enters the programming mode when 21V is supplied to the V_{PP} power supply input and \overline{CE} is at low level. A location is designated by address signals ($A_0 \sim A_{13}$), and the data to be programmed must be applied at 8-bits in parallel to the data inputs ($D_0 \sim D_7$). A program pulse to the \overline{PGM} at this state will effect programming. Only one programming pulse is required, but its width must satisfy the condition $45 \text{ ms} \leq t_{PW} \leq 55 \text{ ms}$.

Erase

Erase is effected by exposure to ultraviolet light with a wavelength of 2537Å at an intensity of approximately 15WS/cm². Sunlight and fluorescent light may contain ultraviolet light sufficient to erase the programmed information. For any operation in the read mode, the transparent lid should be covered with opaque tape.

MODE SELECTION

Mode	Pins						Outputs (11 ~ 13, 15 ~ 19)
	\overline{CE} (20)	\overline{OE} (22)	\overline{PGM} (27)	V_{PP} (1)	V_{CC} (28)		
Read	V_{IL}	V_{IL}	V_{IH}	V_{CC}	V_{CC}		Data out
Standby	V_{IH}	X*	X*	V_{CC}	V_{CC}		Floating
Program	V_{IL}	V_{IH}	V_{IL}	V_{PP}	V_{CC}		Data in
Program verify	V_{IL}	V_{IL}	V_{IH}	V_{PP}	V_{CC}		Data out
Program inhibit	V_{IH}	X*	X*	V_{PP}	V_{CC}		Floating

* : X can be either V_{IL} or V_{IH} .

ABSOLUTE MAXIMUM RATINGS (Note 1)

Symbol	Parameter	Limits	Unit
T_{opr}	Temperature under bias	- 10 ~ 80	°C
T_{stg}	Storage temperature	- 65 ~ 125	°C
V_{I1}	All input or output voltage (Note 2)	0.6 ~ 7	V
V_{I2}	V_{PP} supply voltage during programming (Note 2)	- 0.6 ~ 26.5	V

Note 1: Stresses above those listed may cause permanent damage to the device. This is a stress rating only and functional operation of the device at these or at any other conditions above those indicated in the operational sections of this specification is not implied. Exposure to absolute maximum rating conditions for extended periods affects device reliability.

2: With respect to Ground.

**131 072-BIT(16384-WORD BY 8-BIT)
 ERASABLE AND ELECTRICALLY REPROGRAMMABLE ROM**

READ OPERATION

DC ELECTRICAL CHARACTERISTICS ($T_a = 0 \sim 70^\circ\text{C}$, $V_{CC} = 5V \pm 5\%$, $V_{PP} = V_{CC}$, unless otherwise noted)

Symbol	Parameter	Test conditions	Limits			Unit
			Min	Typ	Max	
I_{LI}	Input load current	$V_{IN} = 5.25V$			10	μA
I_{LO}	Output leakage current	$V_{OUT} = 5.25V$			10	μA
I_{PP1}	V_{PP} current read	$V_{PP} = 5.25V$			5	mA
I_{CC1}	V_{CC} current standby	$\overline{CE} = V_{IH}$			45	mA
I_{CC2}	V_{CC} current Active	$\overline{CE} = \overline{OE} - V_{IL}$			100	mA
V_{IL}	Input low voltage		0.1		0.8	V
V_{IH}	Input high voltage		2.0		$V_{CC} + 1$	V
V_{OL}	Output low voltage	$I_{OL} = 2.1\text{mA}$			0.45	V
V_{OH}	Output high voltage	$I_{OH} = -400\mu\text{A}$	2.4			V

Note 3: Typical values are at $T_a = 25^\circ\text{C}$ and nominal supply voltages.

AC ELECTRICAL CHARACTERISTICS ($T_a = 0 \sim 70^\circ\text{C}$, $V_{CC} = 5V \pm 5\%$, $V_{PP} = V_{CC}$, unless otherwise noted)

Symbol	Parameter	Test conditions	Limits				Unit
			M5L27128K-2		M5L27128K		
			Min	Max	Min	Max	
$t_a(\text{AD})$	Address to output delay	$\overline{CE} = \overline{OE} = V_{IL}$		200		250	ns
$t_a(\overline{CE})$	\overline{CE} to output delay	$\overline{OE} = V_{IL}$		200		250	ns
$t_a(\overline{OE})$	Output enable to output delay	$\overline{CE} = V_{IL}$		75		100	ns
t_{DF}	Output enable high to output float	$\overline{CE} = V_{IL}$	0	60	0	85	ns
t_{OH}	Output hold from \overline{CE} or \overline{OE}	$\overline{CE} = \overline{OE} = V_{IL}$	0		0		ns

Note 4: V_{CC} must be applied simultaneously or before V_{PP} and removed simultaneously or after V_{PP}

AC WAVEFORMS

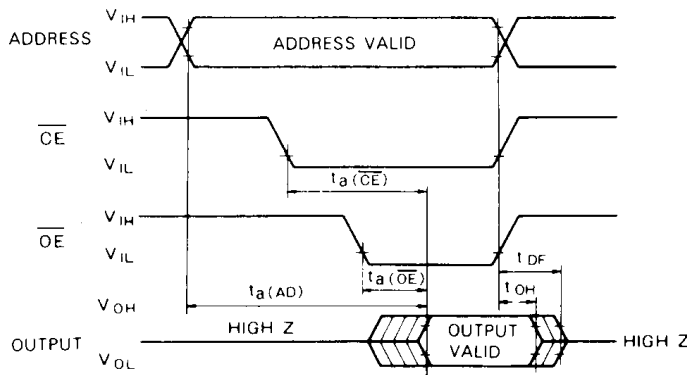

Test conditions for A.C. characteristics
 Input voltage: $V_{IL} = 0.45V$, $V_{IH} = 2.4V$
 Input rise and fall times: $\leq 20\text{ns}$
 Reference voltage at timing measurement: Inputs 1V and 2V Output 0.8V, and 2V

Output load: 1TTL gate + $C_L(100\text{pF})$

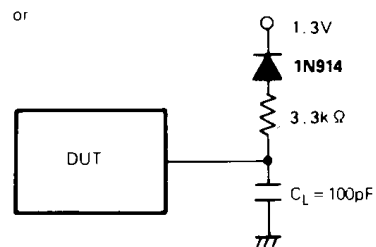

CAPACITANCE

Symbol	Parameter	Test conditions	Limits			Unit
			Min	Typ	Max	
C_{IN}	Input capacitance (Address, \overline{CE} , \overline{OE} , PGM)	$T_a = 25^\circ\text{C}$, $f = 1\text{MHz}$, $V_I = V_O = 0V$		4	6	pF
C_{OUT}	Output capacitance			8	12	pF

**131 072-BIT (16384-WORD BY 8-BIT)
ERASABLE AND ELECTRICALLY REPROGRAMMABLE ROM**

PROGRAM OPERATION

FAST PROGRAMMING ALGORITHM

DC ELECTRICAL CHARACTERISTICS

($T_a = 25 \pm 5^\circ\text{C}$, $V_{CC} = 6V \pm 0.25V$, $V_{PP} = 21V \pm 0.5V$, unless otherwise noted)

Symbol	Parameter	Test conditions	Limits			Unit
			Min	Typ	Max	
I_{LI}	Input current	$V_{IN} = V_{IL}$ or V_{IH}			10	μA
V_{OL}	Output low voltage	$I_{OL} = 2.1\text{mA}$			0.45	V
V_{OH}	Output high voltage	$I_{OH} = -400\mu\text{A}$	2.4			V
V_{IL}	Input low voltage		-0.1		0.8	V
V_{IH}	Input high voltage		2.0		V_{CC}	V
I_{CC2}	V_{CC} supply current				100	mA
I_{PP2}	V_{PP} supply current	$\overline{CE} = V_{IL} = \text{PGM}$			30	mA

AC ELECTRICAL CHARACTERISTICS

($T_a = 25 \pm 5^\circ\text{C}$, $V_{CC} = 6V \pm 0.25V$, $V_{PP} = 21V \pm 0.5V$, unless otherwise noted)

Symbol	Parameter	Test conditions	Limits			Unit
			Min	Typ	Max	
t_{AS}	Address setup time		2			μs
t_{OES}	\overline{OE} set up time		2			μs
t_{DS}	Data setup time		2			μs
t_{AH}	Address hold time		0			μs
t_{DH}	Data hold time		2			μs
t_{DFP}	Output enable to output float delay		0		130	ns
t_{VCS}	V_{CC} setup time		2			μs
t_{VPS}	V_{PP} setup time		2			μs
t_{FPW}	PGM initial program pulse width		0.95	1	1.05	ms
t_{OPW}	PGM over program pulse width		3.8		63	ms
t_{CES}	\overline{CE} setup time		2			μs
t_{OE}	Data valid from \overline{OE}				150	ns

Note 5: V_{CC} must be applied simultaneously or before V_{PP} and removed simultaneously or after V_{PP} .

**131 072-BIT (16384-WORD BY 8-BIT)
 ERASABLE AND ELECTRICALLY REPROGRAMMABLE ROM**

AC WAVEFORMS

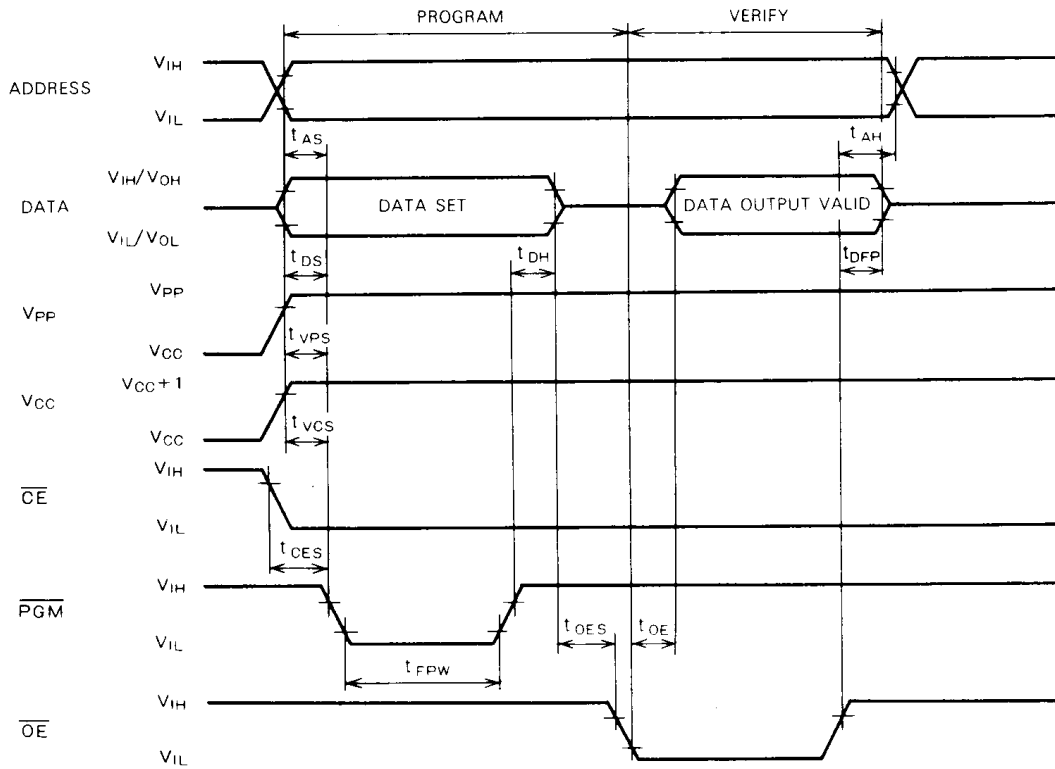

Test conditions for A.C. characteristics
 Input voltage: $V_{IL} = 0.45V$, $V_{IH} = 2.4V$
 Input rise and fall times: $\leq 20ns$
 Reference voltage at timing measurement: Input 0.8V
 and 2V Output 0.8V, and 2V

**131 072-BIT (16384-WORD BY 8-BIT)
 ERASABLE AND ELECTRICALLY REPROGRAMMABLE ROM**

**FAST PROGRAMMING ALGORITHM
 FLOW CHART**

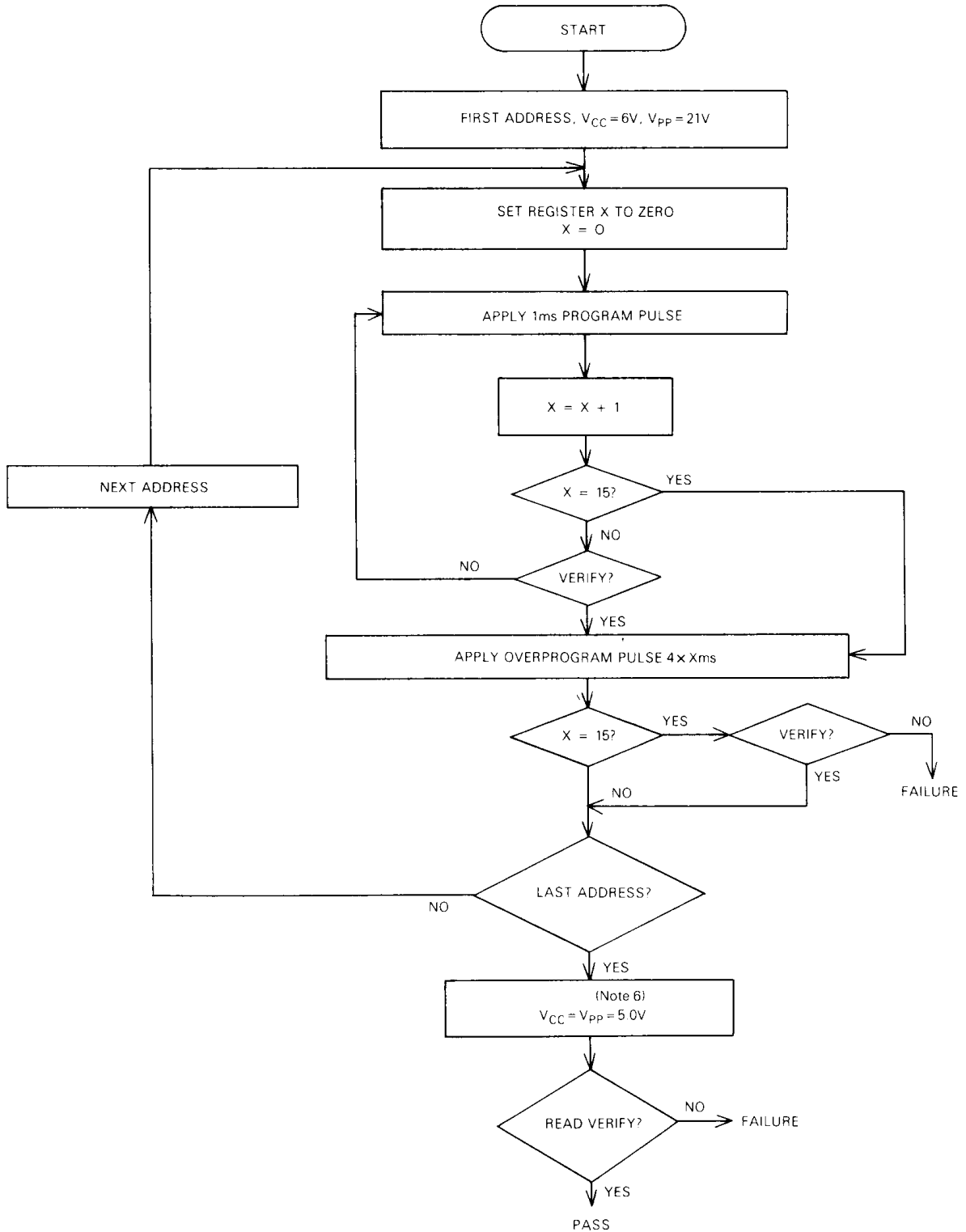

Note 6. $4.75 \leq V_{CC} = V_{pp} \leq 5.25V$

**131 072-BIT(16384-WORD BY 8-BIT)
 ERASABLE AND ELECTRICALLY REPROGRAMMABLE ROM**

CONVENTIONAL PROGRAMMING ALGORITHM

DC ELECTRICAL CHARACTERISTICS ($T_a = 25 \pm 5^\circ\text{C}$, $V_{CC} = 5V \pm 5\%$, $V_{PP} = 21V \pm 0.5V$, unless otherwise noted)

Symbol	Parameter	Test conditions	Limits			Unit
			Min	Typ	Max	
I_{LI}	Input current	$V_{IN} = V_{IL}$ or V_{IH}			10	μA
V_{OL}	Output low voltage	$I_{OL} = 2.1\text{mA}$			0.45	V
V_{OH}	Output high voltage	$I_{OH} = -400\mu\text{A}$	2.4			V
V_{IL}	Input low voltage		-0.1		0.8	V
V_{IH}	Input high voltage		2.0		$V_{CC} + 1$	V
I_{CC2}	V_{CC} Supply current				100	mA
I_{PP2}	V_{PP} Supply current	$\overline{CE} = V_{IL} = \text{PGM}$			30	mA

AC ELECTRICAL CHARACTERISTICS ($T_a = 25 \pm 5^\circ\text{C}$, $V_{CC} = 5V \pm 5\%$, $V_{PP} = 21V \pm 0.5V$, unless otherwise noted)

Symbol	Parameter	Test conditions	Limits			Unit
			Min	Typ	Max	
t_{AS}	Address set up time		2			μs
t_{OES}	\overline{OE} setup time		2			μs
t_{DS}	Data setup time		2			μs
t_{AH}	Address hold time		0			μs
t_{DH}	Data hold time		2			μs
t_{DFP}	Output enable to output delay		0		130	ns
t_{VS}	V_{PP} setup time		2			μs
t_{PW}	PGM Pulse width (during program)		45	50	55	ms
t_{CES}	\overline{CE} setup time		2			μs
t_{OE}	Data valid from \overline{OE}				150	ns

Note 7: V_{CC} must be applied simultaneously or before V_{PP} and removed simultaneously or after V_{PP} .

**131 072-BIT(16384-WORD BY 8-BIT)
 ERASABLE AND ELECTRICALLY REPROGRAMMABLE ROM**

AC WAVEFORMS

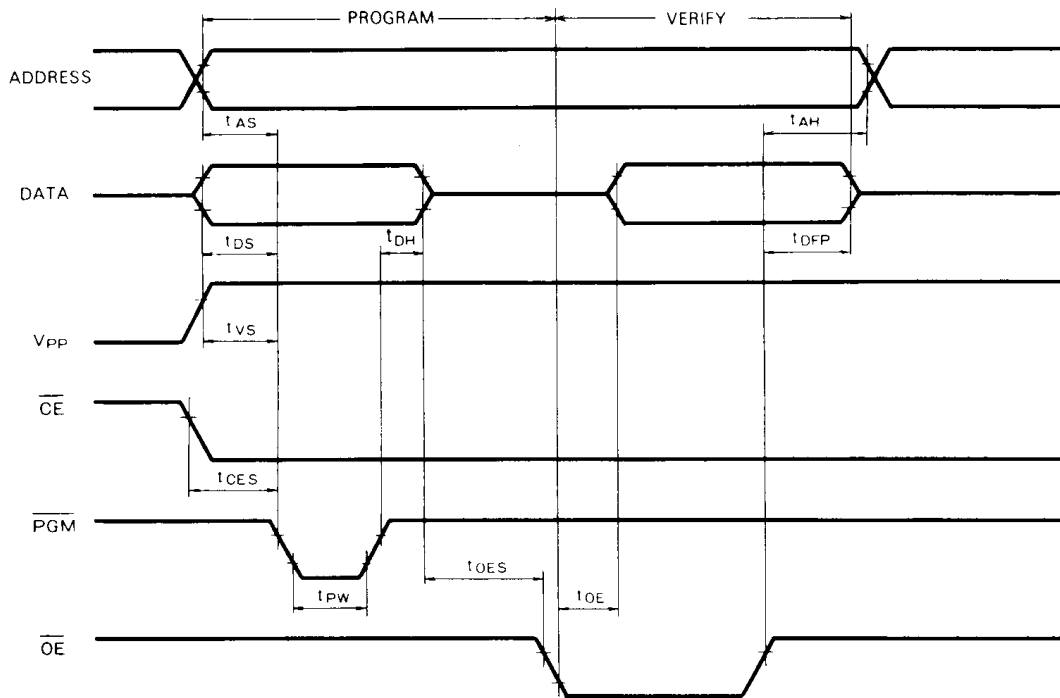

Test conditions for A.C. characteristics
 Input rise and fall time: $\leq 20\text{ns}$
 Input voltage: $V_{IL} = 0.45\text{V}$, $V_{IH} = 2.4\text{V}$
 Reference voltage at timing measurement: Input 0.8V and 2V
 Outputs 0.8V and 2V

**131 072-BIT(16384-WORD BY 8-BIT)
 ERASABLE AND ELECTRICALLY REPROGRAMMABLE ROM**

TYPICAL CHARACTERISTICS

**ACCESS TIME VS
 OPERATING TEMPERATURE**

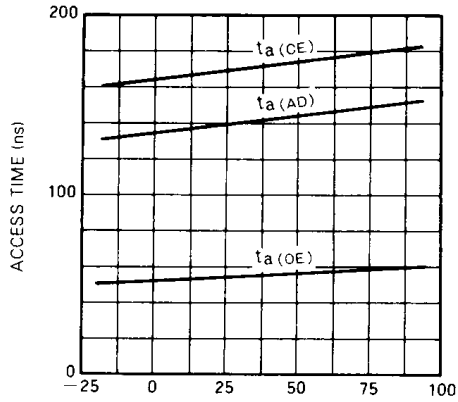

OPERATING TEMPERATURE t_a (°C)

**SUPPLY CURRENT VS
 SUPPLY VOLTAGE**

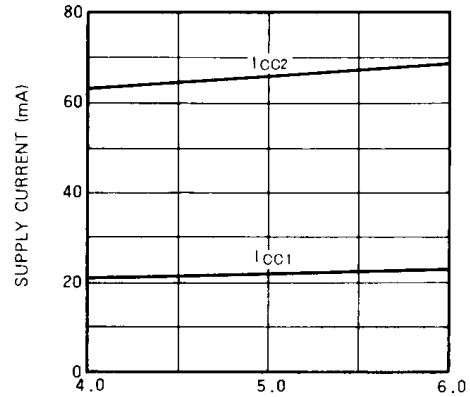

SUPPLY VOLTAGE V_{CC} (V)

**SUPPLY CURRENT VS
 OPERATING TEMPERATURE**

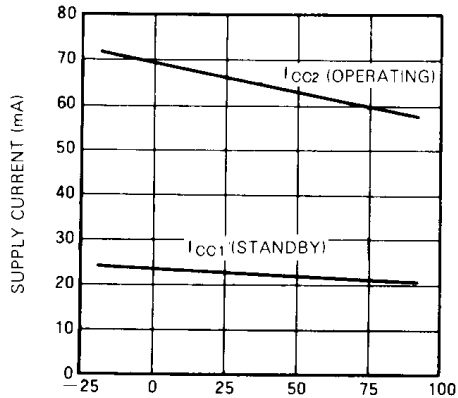

OPERATING TEMPERATURE T_a (°C)

OUTPUT CHARACTERISTICS

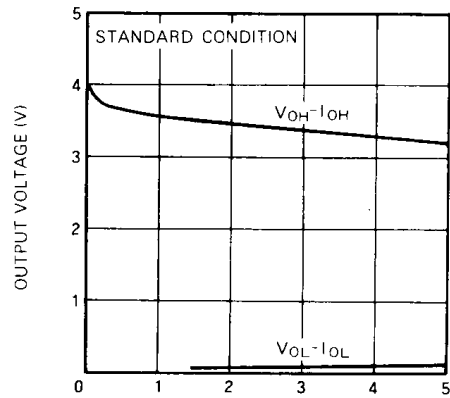

OUTPUT CURRENT (mA)