

# DATA SHEET

## **TDA1592**

PLL stereo decoder and noise  
blanker

Preliminary specification  
Supersedes data of June 1993  
File under Integrated Circuits, IC01

1996 May 31

## PLL stereo decoder and noise blanker

## TDA1592

### FEATURES

- Adjustment-free voltage controlled PLL oscillator for ceramic resonator ( $f = 456$  kHz)
- Pilot signal dependent mono/stereo switching
- Analog control of mono/stereo change over [stereo blend, Stereo Noise Controller (SNC)]
- Adjacent channel noise suppression (114 kHz)
- Pilot canceller
- Analog control of de-emphasis; High Cut Control (HCC)
- Reduced and controlled de-emphasis for AM operation (pin 7 to GND)
- Applicable as source selector for AM/FM/cassette switching
- Soft mute for silent tuning
- Separate interference noise detector
- Integrated input low-pass filter for delayed noise blanking
- Noise blanking at MPX-demodulator outputs.

### GENERAL DESCRIPTION

The TDA1592 is a monolithic bipolar integrated circuit providing the stereo decoder function and noise blanking for FM car radio applications.

The device operates in a power supply range of 7.5 to 12 V.

### QUICK REFERENCE DATA

| SYMBOL        | PARAMETER                          | MIN. | TYP. | MAX. | UNIT |
|---------------|------------------------------------|------|------|------|------|
| $V_P$         | supply voltage (pin 5)             | 7.5  | 10   | 12   | V    |
| $I_P$         | supply current                     | –    | 15   | 20   | mA   |
| $V_{o(rms)}$  | audio output signal (RMS value)    | 800  | 900  | 1000 | mV   |
| THD           | total harmonic distortion          | –    | 0.1  | 0.3  | %    |
| S/N           | signal-to-noise ratio              | –    | 82   | –    | dB   |
| $\alpha_{cs}$ | channel separation                 | 30   | 40   | –    | dB   |
| $V_{trigg}$   | interference voltage trigger level | –    | 10   | –    | mV   |

### ORDERING INFORMATION

| TYPE NUMBER | PACKAGE |  |          |
|-------------|---------|--|----------|
|             | NAME    | DESCRIPTION  | VERSION  |
| TDA1592     | DIP20   | plastic dual in-line package; 20 leads (300 mil)           | SOT146-1 |
| TDA1592T    | SO20    | plastic small outline package; 20 leads; body width 7.5 mm | SOT163-1 |

PLL stereo decoder and noise blanker

TDA1592

BLOCK DIAGRAM

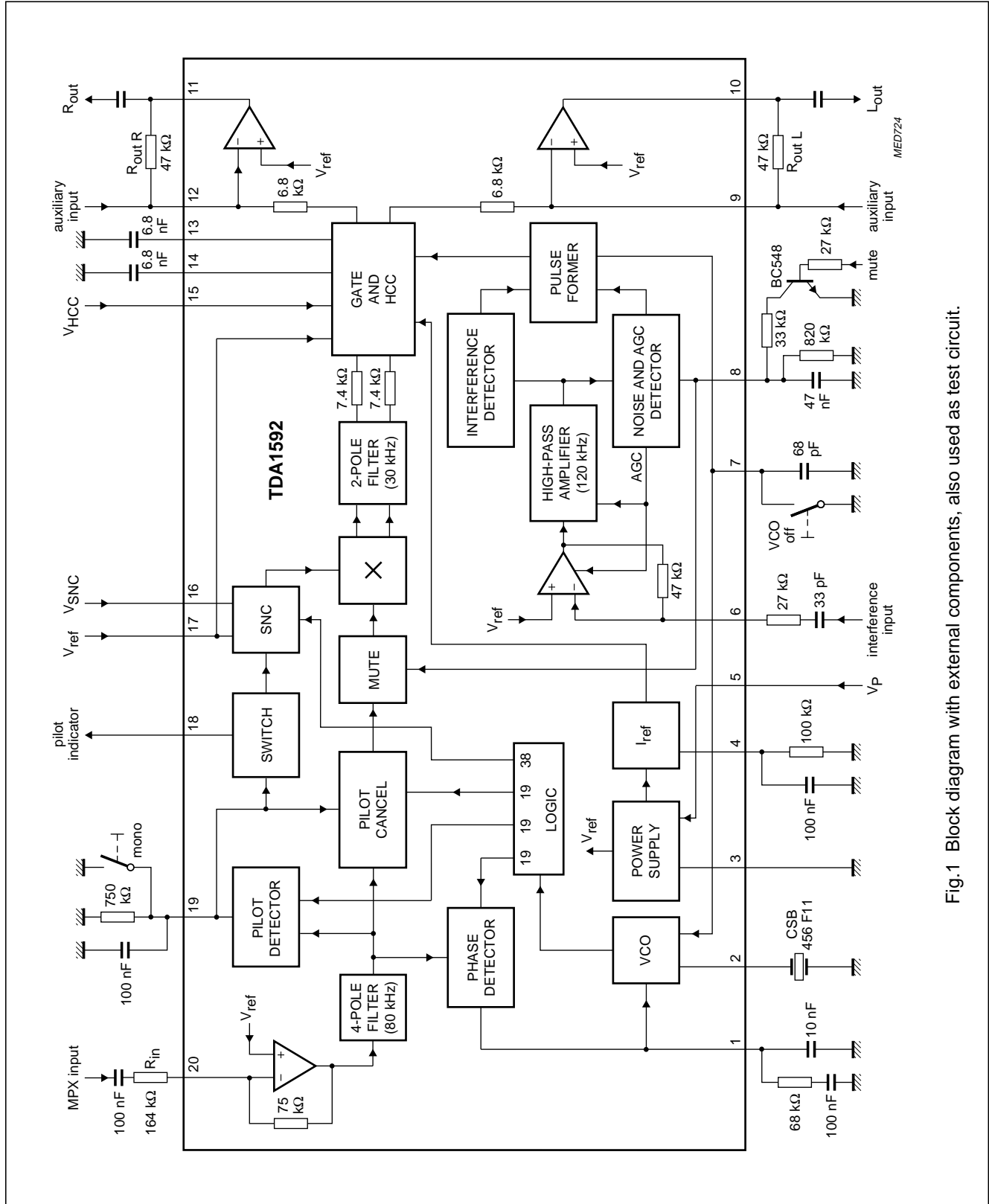

Fig.1 Block diagram with external components, also used as test circuit.

PLL stereo decoder and noise blanker

TDA1592

PINNING

| SYMBOL             | PIN | DESCRIPTION   |
|--------------------|-----|---|
| PLL                | 1   | phase locked loop filter                              |
| OSC                | 2   | oscillator input/output pin for ceramic resonator     |
| GND                | 3   | ground (0 V)  |
| I <sub>ref</sub>   | 4   | reference current                                     |
| V <sub>P</sub>     | 5   | supply voltage (+10 V)                                |
| INFI               | 6   | interference signal input                             |
| PUFO               | 7   | pulse former time constant; VCO <b>off</b>            |
| NDET               | 8   | noise detector time constant; mute <b>on</b>          |
| FB-L               | 9   | AF feedback input for left audio signal               |
| V <sub>oL</sub>    | 10  | AF output signal left                                 |
| V <sub>oR</sub>    | 11  | AF output signal right                                |
| FB-R               | 12  | AF feedback input for right audio signal              |
| C <sub>DEEL</sub>  | 13  | de-emphasis capacitor for left channel                |
| C <sub>DEER</sub>  | 14  | de-emphasis capacitor for right channel               |
| HCC                | 15  | HCC input for de-emphasis control                     |
| SNC                | 16  | stereo blend input                                    |
| V <sub>ref</sub>   | 17  | externally applied reference voltage of 1 to 5 V      |
| IDENT              | 18  | identification output (HIGH = pilot existing; stereo) |
| PILOT              | 19  | pilot detector level (forced mono input)              |
| V <sub>i MPX</sub> | 20  | MPX input signal from IF demodulator                  |

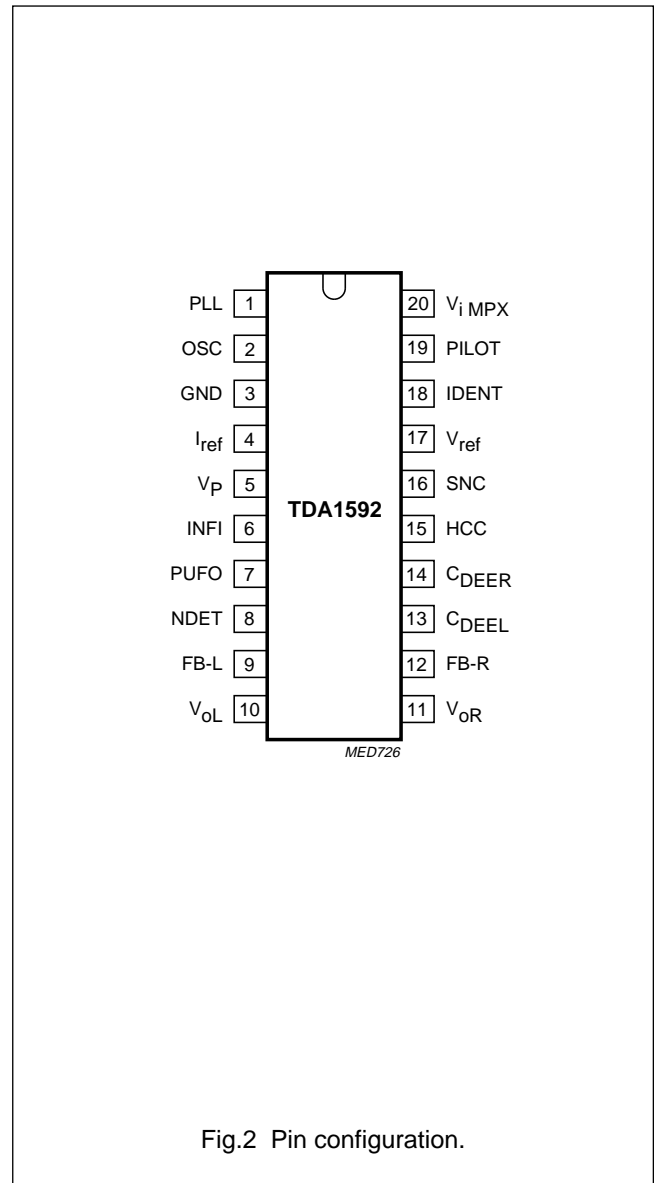

Fig.2 Pin configuration.

## PLL stereo decoder and noise blanker

## TDA1592

### FUNCTIONAL DESCRIPTION

The MPX input of the TDA1592 (pin 20) is the null-node of an operational amplifier with internal feedback resistor. Adapting the stereo decoder input to the level of the FM demodulator output is realized by the value of input resistor  $R_{in}$  (see Fig.3). The total gain of the stereo decoder is applicable by varying the feedback resistors  $R_{out}$  (pins 9, 10, 11 and 12) of the output operational amplifiers (see Fig.4).

The input amplifier is followed by an integrated 4<sup>th</sup> order Bessel low-pass filter with a cut-off frequency of 80 kHz. It provides necessary signal delay for noise blanking and damping of high frequency interferences at the stereo decoder input.

The soft mute facility (pin 8) provides silent tuning for RDS processing. The mute time constant may be adjusted from pin 8. In mute position and the VCO switched **off** (pin 7), the output amplifiers can be used for cassette playback, AM stereo purpose or other signal sources.

The voltage to current converted MPX signal is fed to phase detector, pilot detector and pilot canceller circuits. The oscillator is alignment-free with an external ceramic resonator at 456 kHz as reference (pin 2). The required 19 kHz and 38 kHz signals are generated by division of the oscillator output signal in a logical circuit. For regeneration of the 38 kHz subcarrier, a PLL is used. The 19 kHz quadrature phase signal is fed to the 19 kHz phase detector, where it is compared with the incoming pilot tone. The DC output signal of the phase detector (pin 1) controls the oscillator (PLL).

The pilot presence detector is driven by internally generated in-phase 19 kHz. Its pilot-dependent DC output voltage (pin 19) is fed to a threshold switch, which activates the pilot indicator logic output (pin 18) and turns the stereo decoder to stereo operation. The same DC voltage is used to control the amplitude of an anti-phase internally generated 19 kHz signal. In the pilot canceller, the pilot tone is compensated by this anti-phase 19 kHz signal.

The pilot cancelled signal is fed to the multiplex decoder. There, the side signal is demodulated and combined with the main signal in a matrix to left and right audio channel.

Compensation for roll-off in the incoming MPX signal caused by IF filters and FM demodulator is realized by corresponding side signal amplification.

A smooth mono to stereo take-over, which is controlled by the level detector voltage of the IF part, is achieved by the SNC (pins 16 and 17; see Fig.6).

From the output of the MPX demodulator the signals are fed to 2-pole low-pass filters with a cut-off frequency of 30 kHz to provide additional signal delay for noise blanking and attenuation of the subcarrier and its harmonics.

These filters are followed by the noise suppression gates, which are combined with de-emphasis and HCC. The de-emphasis is defined by internal resistors (aligned by an external current) and external capacitors (pins 13 and 14). For HCC, the de-emphasis time constant can be changed to higher values (pins 15 and 17; see Figs 7 to 9). This function is controlled by an analog input signal, derived from the level detector voltage of the IF part. When the VCO is turned **off** (pin 7 to GND), de-emphasis is reduced to 20  $\mu$ s for full frequency response when AM-AF is fed through the stereo decoder. De-emphasis remains controllable.

From the gate circuits audio is fed through internal series resistors to the inverting inputs of the output operational amplifiers (pins 9 and 12), which can also be used as signal inputs for cassette playback or other sources when the mute is activated. The gain of these amplifiers is defined by external feedback resistors  $R_{out}$  (pins 9, 10, 11 and 12).

The input of the ignition noise blanker is the null node of an operational amplifier (pin 6). It can be driven by the level detector output of the FM-IF limiter and/or the MPX signal. Its sensitivity is dependent on the value of the series input resistor at pin 6.

The operational amplifier output signal is fed through an integrated 120 kHz high-pass filter, becomes amplified and is then fed in parallel to the noise detector and the interference detector. The noise detector is a negative peak detector. Its output (pin 8) controls the trigger sensitivity (prevention to false triggering at noisy input signals) and the attenuation of the input operational amplifier. The output of the interference detector, when receiving a steep pulse, triggers a mono flip-flop, which is a part of the pulse former circuit. The time constant of the mono flip-flop is defined by an external capacitor (pin 7) and its output activates the blanking gates in the audio.

## PLL stereo decoder and noise blanker

TDA1592

**LIMITING VALUES**

In accordance with the Absolute Maximum Rating System (IEC 134).

| SYMBOL    | PARAMETER                                   | MIN. | MAX. | UNIT |
|-----------|---|------|------|------|
| $V_P$     | supply voltage (pin 5)                      | 0    | 13.2 | V    |
| $P_{tot}$ | total power dissipation                     | 0    | 0.25 | W    |
| $T_{stg}$ | storage temperature                         | -55  | +150 | °C   |
| $T_{amb}$ | operating ambient temperature               | -40  | +85  | °C   |
| $V_{es}$  | electrostatic handling for all pins; note 1 | -400 | +400 | V    |

**Note**

1. Equivalent to discharging a 200 pF capacitor through a 0  $\Omega$  series resistor.

**CHARACTERISTICS**

$V_P = 10$  V;  $T_{amb} = 25$  °C; input signal  $V_{i MPX(p-p)} = 1.7$  V;  $m = 100\%$  ( $\Delta f = \pm 75$  kHz,  $f_{mod} = 1$  kHz); de-emphasis of 50  $\mu$ s and series resistor at input  $R_1 = 164$  k $\Omega$ ; measurements taken in Fig.1; unless otherwise specified.

| SYMBOL                  | PARAMETER   | CONDITIONS                             | MIN.                       | TYP. | MAX. | UNIT       |
|-------------------------|---|--|----------------------------|------|------|------------|
| $V_P$                   | supply voltage (pin 5)                              |  | 7.5                        | 10   | 12   | V          |
| $I_P$                   | supply current                                      |  | –                          | 15   | 20   | mA         |
| <b>Stereo decoder</b>   |   |  |                            |      |      |            |
| $V_{i MPX(p-p)}$        | MPX input signal                                    |  | –                          | 1.7  | –    | V          |
| $\Delta V_{i MPX(p-p)}$ | overdrive margin of MPX input signal                | THD = 1%                               | 6                          | –    | –    | dB         |
| $V_{o(rms)}$            | AF mono output signal at pins 10 and 11 (RMS value) | without pilot                          | 800                        | 900  | 1000 | mV         |
| $\Delta V_o$            | overdrive margin of output signal                   | THD = 1%                               | 6                          | –    | –    | dB         |
| $V_{10-11}/V_o$         | difference of output voltage levels                 |  | –                          | –    | 1    | dB         |
| $V_{o 10,11}$           | DC output voltage (pins 10 and 11)                  |  | 3.2                        | 3.7  | 4.2  | V          |
| $R_{o 10,11}$           | output resistance                                   |  | –                          | 150  | –    | $\Omega$   |
| $I_o$                   | output current                                      |  | 330                        | 400  | –    | $\mu$ A    |
| $R_{2,3}$               | maximum feedback resistor                           |  | –                          | –    | 68   | k $\Omega$ |
| $V_{4,3}$               | reference voltage                                   |  | 3.7                        | 3.8  | 3.9  | V          |
| $\alpha_{cs}$           | channel separation                                  | pin 16 open-circuit; see Fig.6         | 30                         | 40   | –    | dB         |
| THD                     | total harmonic distortion                           |  | –                          | 0.1  | 0.3  | %          |
| S/N                     | signal-to-noise ratio                               | $f = 20$ to 16000 Hz                   | 77                         | 82   | –    | dB         |
| $\alpha_{19}$           | pilot signal suppression                            | $f = 19$ kHz                           | 40                         | 50   | –    | dB         |
| $\alpha_{38}$           | subcarrier suppression                              | $f = 38$ kHz                           | 35                         | 50   | –    | dB         |
| $\alpha_{57}$           |   | $f = 57$ kHz                           | 46                         | –    | –    | dB         |
| $\alpha_{76}$           |   | $f = 76$ kHz                           | –                          | 60   | –    | dB         |
| IM2                     |   | intermodulation for $f_{spur} = 1$ kHz | $f_{mod} = 10$ kHz; note 1 | –    | 60   | –          |
| IM3                     |   | $f_{mod} = 13$ kHz                     | –                          | 58   | –    | dB         |
| $\alpha_{57 VF}$        | traffic radio (VWF)                                 | $f = 57$ kHz; note 2                   | –                          | 70   | –    | dB         |
| $\alpha_{67}$           | SCA (Subsidiary Communications Authorization)       | $f = 67$ kHz; note 3                   | 70                         | –    | –    | dB         |

## PLL stereo decoder and noise blanker

## TDA1592

| SYMBOL   | PARAMETER  | CONDITIONS  | MIN. | TYP.       | MAX.     | UNIT          |
|--|--|---|------|------------|----------|---------------|
| $\alpha_{114}$                                     | ACI (Adjacent Channel Interference)  | f = 114 kHz; note 4                                       | –    | 80         | –        | dB            |
| $\alpha_{190}$                                     |  | f = 190 kHz; note 4                                       | –    | 70         | –        | dB            |
| PSRR   | power supply ripple rejection  | f = 100 Hz;<br>$V_{\text{ripple (rms)}} = 100 \text{ mV}$ | –    | 35         | –        | dB            |
| <b>VCO (pin 2)</b>                                 |  |   |      |            |          |               |
| $f_{\text{osc}}$                                   | oscillator frequency (ceramic resonator)   |   | –    | 456        | –        | kHz           |
|  | frequency range of free running oscillator   |   | 451  | –          | 459      | kHz           |
| $\Delta f/f$                                       | capture and holding range  |   | –    | $\pm 0.65$ | –        | %             |
| $V_7$  | VCO-off voltage (pin 7)  |   | 0    | –          | 0.6      | V             |
| <b>Mono/stereo control (pins 16, 17 and 19)</b>    |  |   |      |            |          |               |
| $V_{i \text{ pilot}}$                              | pilot threshold voltage for automatic switching by pilot input voltage (RMS value) | stereo <b>on</b>  | –    | 24         | 30       | mV            |
|  |  | stereo <b>off</b>   | 8    | 20         | –        | mV            |
| HYS  | hysteresis of pilot threshold voltage  |   | –    | 2          | –        | dB            |
| $V_{19}$   | switching voltage for external mono control (pin 19)                               |   | –    | –          | 0.7      | V             |
| $V_{\text{ref}}$                                   | reference input voltage range (pin 17)   |   | 1    | –          | 5        | V             |
| $V_{16-17}$  | control voltage for channel separation due to pin 17 ( $V_{\text{ref}}$ )          | $\alpha_{\text{CS}} = 6 \text{ dB}$ ; see Fig.5           | –80  | –100       | –120     | mV            |
|  |  | $\alpha_{\text{CS}} = 20 \text{ dB}$ ; see Fig.5          | –40  | –55        | –70      | mV            |
| <b>Pilot indicator logic level output (pin 18)</b> |  |   |      |            |          |               |
| $V_{18}$   | LOW voltage  | $I_{18} = 500 \mu\text{A}$                                | –    | 250        | 400      | mV            |
| $I_{18}$   | HIGH current   | $V_{18} = 10 \text{ V}$                                   | –    | –          | 1        | $\mu\text{A}$ |
| <b>Muting (pin 8)</b>                              |  |   |      |            |          |               |
| $\text{MUTE}_{\text{att}}$                         | mute attenuation (pin 8)   | $V_8 < 1.6 \text{ V}$                                     | 80   | –          | –        | dB            |
|  |  | $V_8 > 4 \text{ V}$                                       | –    | –          | 0.2      | dB            |
| $V_{\text{O(offset)}}$                             | DC offset voltage (pins 10 and 11)   | after muting  | –    | –          | $\pm 50$ | mV            |
| <b>HCC (pin 15)</b>                                |  |   |      |            |          |               |
| $\text{CR}_{\text{deem}}$                          | control range of de-emphasis for European standard<br>for USA standard             | $C_{\text{deem}} = 6.8 \text{ nF}$                        | 50   | –          | 150      | $\mu\text{s}$ |
|  |  | $C_{\text{deem}} = 10 \text{ nF}$                         | 75   | –          | 225      | $\mu\text{s}$ |
| $V_{15-17}$  | control voltage (pin 15 due to pin 17) in both standards                           | lower value $\text{CR}_{\text{deem}}$                     | –    | 0          | –        | mV            |
|  |  | upper value $\text{CR}_{\text{deem}}$                     | –    | –300       | –        | mV            |

## PLL stereo decoder and noise blanker

## TDA1592

| SYMBOL                              | PARAMETER   | CONDITIONS                      | MIN. | TYP. | MAX. | UNIT |
|-------------------------------------|---|---------------------------------|------|------|------|------|
| <b>HCC (pin 15, pin 7 to GND)</b>   |   |                                 |      |      |      |      |
| CR <sub>deem</sub>                  | control range of de-emphasis<br>for European standard<br>for USA standard | see Fig.9                       |      |      |      |      |
|                                     |   | C <sub>deem</sub> = 6.8 nF      | 15   | –    | 90   | μs   |
|                                     |   | C <sub>deem</sub> = 10 nF       | 22   | –    | 135  | μs   |
| V <sub>15-17</sub>                  | control voltage (pin 15 due to pin 17) in both standards                  | lower value CR <sub>deem</sub>  | –    | 0    | –    | mV   |
|                                     |   | upper value CR <sub>deem</sub>  | –    | –300 | –    | mV   |
| ΔV <sub>10</sub> , ΔV <sub>11</sub> | DC offset voltage at AF outputs (AM on/off)                               |                                 | –    | –    | ±200 | mV   |
| <b>Noise interference detector</b>  |   |                                 |      |      |      |      |
| V <sub>pulse</sub>                  | trigger sensitivity   | τ <sub>pulse</sub> = 10 μs      | –    | 10   | –    | mV   |
| ΔV <sub>8</sub>                     | trigger threshold voltage offset as a function of V <sub>trigg</sub>      | f <sub>int</sub> = 120 kHz      |      |      |      |      |
|                                     |   | V <sub>interf.in</sub> = 10 mV  | 150  | 200  | 250  | mV   |
|                                     |   | V <sub>interf.in</sub> = 100 mV | 550  | 650  | 750  | mV   |
| t <sub>sup</sub>                    | AF suppression time; pulse width  |                                 | –    | 40   | –    | μs   |
| I <sub>13,14</sub>                  | input offset current (pins 13 and 14)                                     | during AF suppression time      | –    | 20   | –    | nA   |

**Notes**

1. Intermodulation suppression [Beat Frequency Components (BFC)]:

$$IM2 = \frac{V_{o(\text{signal})}(\text{at } 1 \text{ kHz})}{V_{o(\text{spurious})}(\text{at } 1 \text{ kHz})}; f_s = (2 \times 10 \text{ kHz}) - 19 \text{ kHz}$$

$$IM3 = \frac{V_{o(\text{signal})}(\text{at } 1 \text{ kHz})}{V_{o(\text{spurious})}(\text{at } 1 \text{ kHz})}; f_s = (3 \times 13 \text{ kHz}) - 38 \text{ kHz}$$

measured with 91% mono signal; f<sub>mod</sub> = 10 kHz or 13 kHz; 9% pilot signal.

2. ARI suppression:

$$\alpha_{57}ARI = \frac{V_{o(\text{signal})}(\text{at } 1 \text{ kHz})}{V_{o(\text{spurious})}(\text{at } 1 \text{ kHz} \pm 23 \text{ Hz})}$$

measured with 91% stereo signal; f<sub>mod</sub> = 1 kHz; 9% pilot signal; 5% ARI subcarrier (f<sub>s</sub> = 57 kHz; f<sub>mod</sub> = 23 Hz; AM m = 0.6).

3. Subsidiary Communication Authorization (SCA):

$$\alpha_{67} = \frac{V_{o(\text{signal})}(\text{at } 1 \text{ kHz})}{V_{o(\text{spurious})}(\text{at } 9 \text{ kHz})}; f_s = (2 \times 38 \text{ kHz}) - 67 \text{ kHz}$$

measured with 81% mono signal; f<sub>mod</sub> = 1 kHz; 9% pilot signal; 10% SCA subcarrier (f<sub>s</sub> = 67 kHz, unmodulated).

4. Adjacent Channel Interference (ACI):

$$\alpha_{114} = \frac{V_{o(\text{signal})}(\text{at } 1 \text{ kHz})}{V_{o(\text{spurious})}(\text{at } 4 \text{ kHz})}; f_s = 110 \text{ kHz} - (3 \times 38 \text{ kHz})$$

$$\alpha_{190} = \frac{V_{o(\text{signal})}(\text{at } 1 \text{ kHz})}{V_{o(\text{spurious})}(\text{at } 4 \text{ kHz})}; f_s = 186 \text{ kHz} - (5 \times 38 \text{ kHz})$$

measured with 90% mono signal; f<sub>mod</sub> = 1 kHz; 9% pilot signal; 1% spurious signal (f<sub>s</sub> = 110 kHz or 186 kHz, unmodulated).



PLL stereo decoder and noise blanker

TDA1592

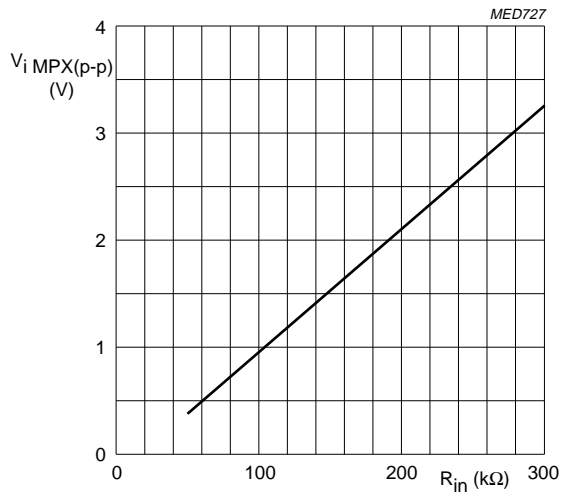

Fig.3 Input signal as a function of series input resistor  $R_{in}$ .

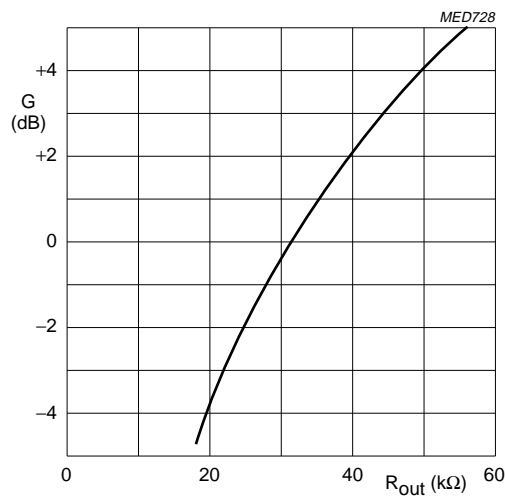
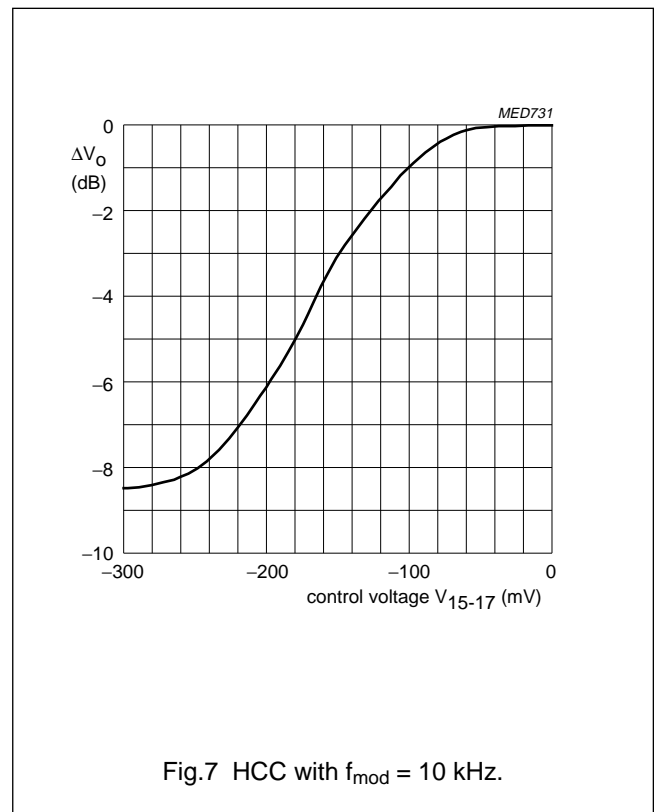
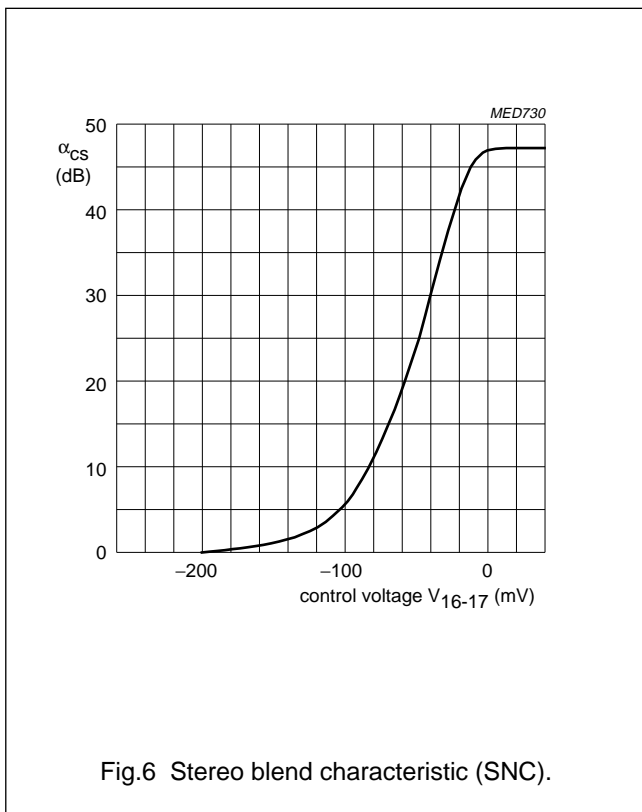
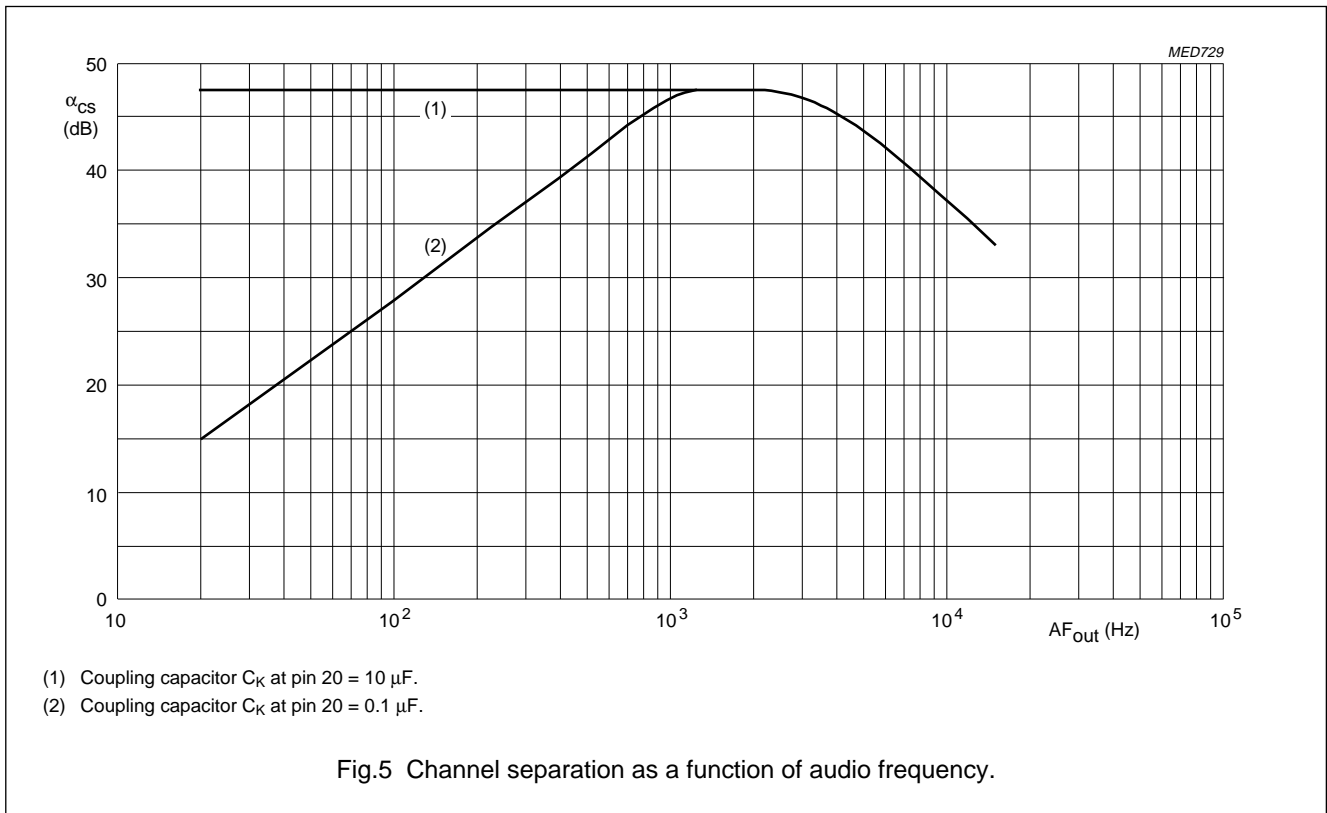

Fig.4 Overall signal gain as a function of feedback resistors  $R_{out}$  ( $R_{in} = 164 k\Omega$ ).

PLL stereo decoder and noise blanker

TDA1592



PLL stereo decoder and noise blanker

TDA1592

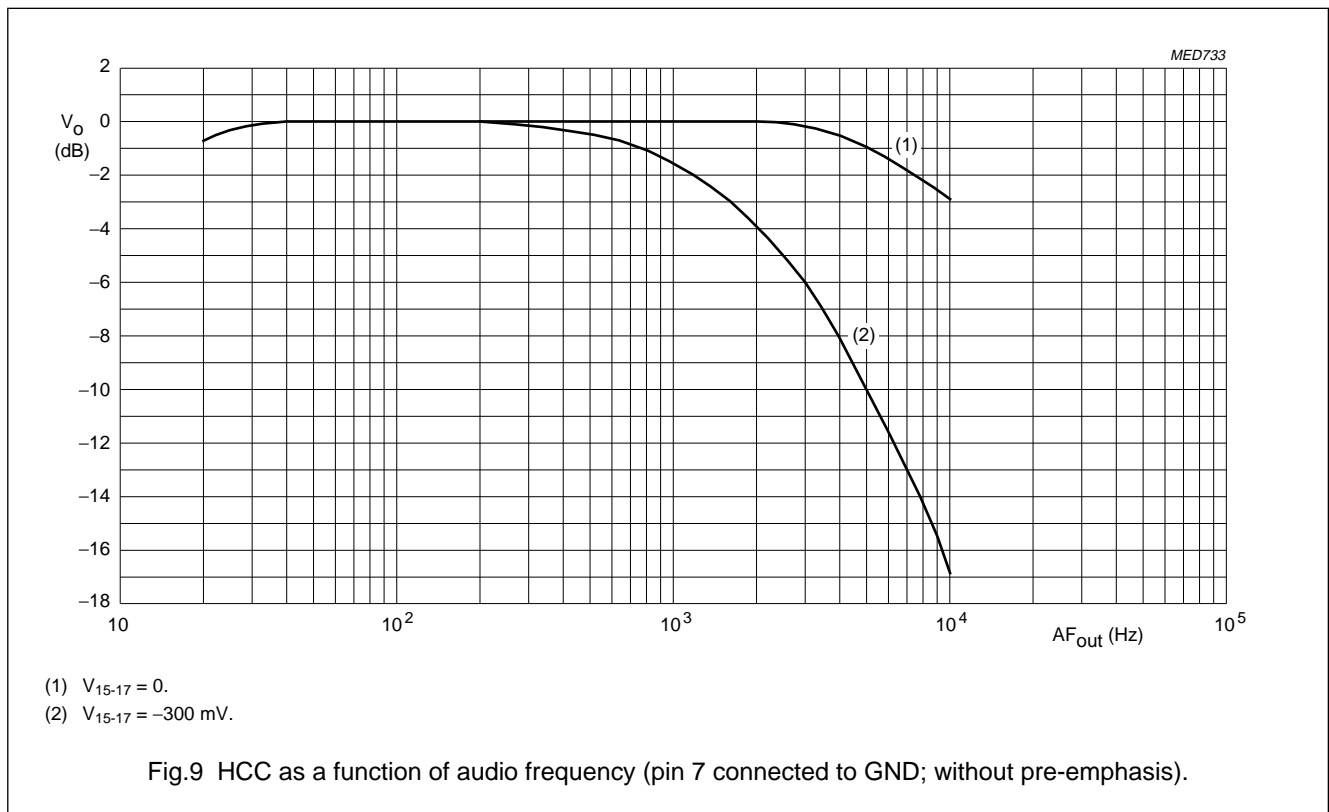
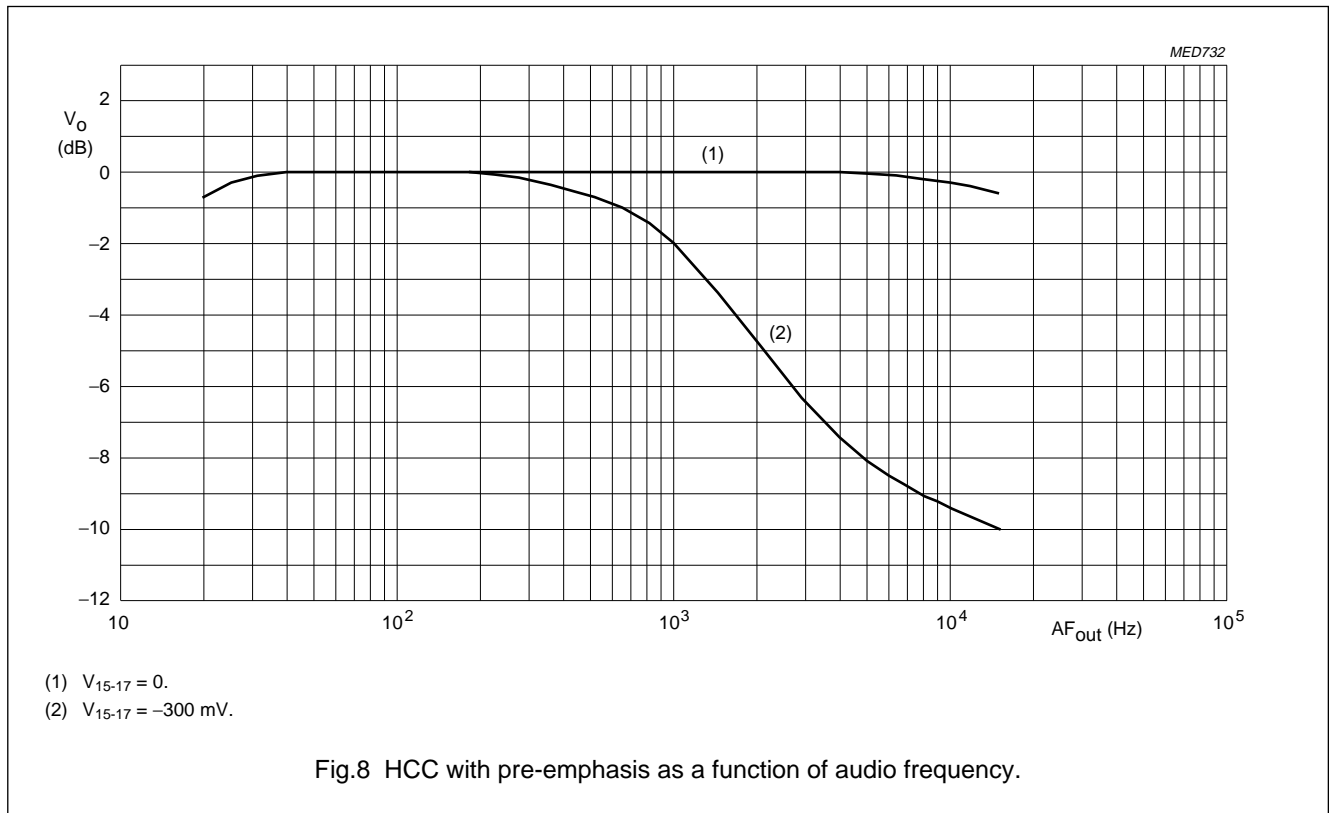

PLL stereo decoder and noise blanker

TDA1592

INTERNAL PIN CONFIGURATION

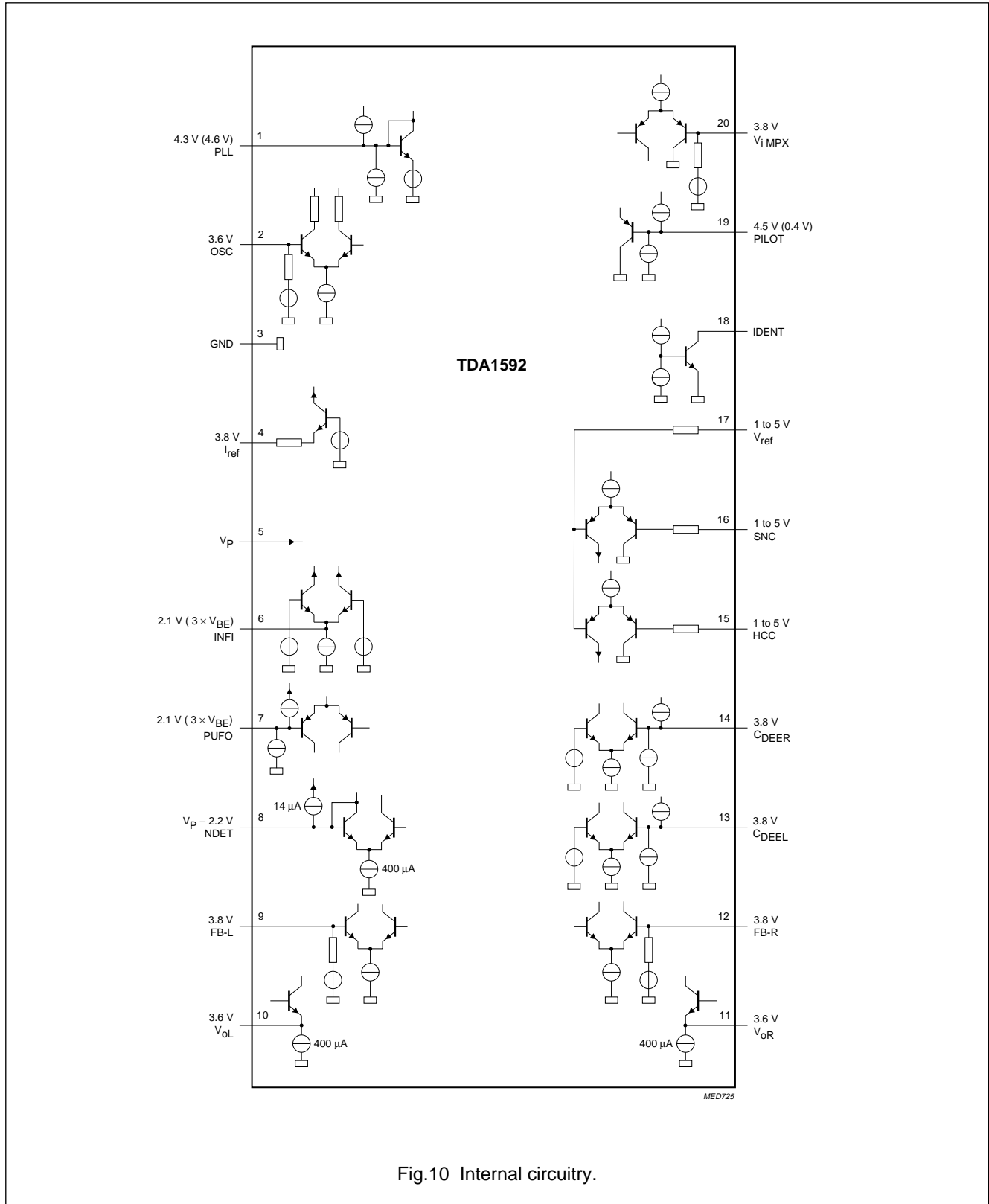

Fig.10 Internal circuitry.

PLL stereo decoder and noise blanker

TDA1592

TEST INFORMATION

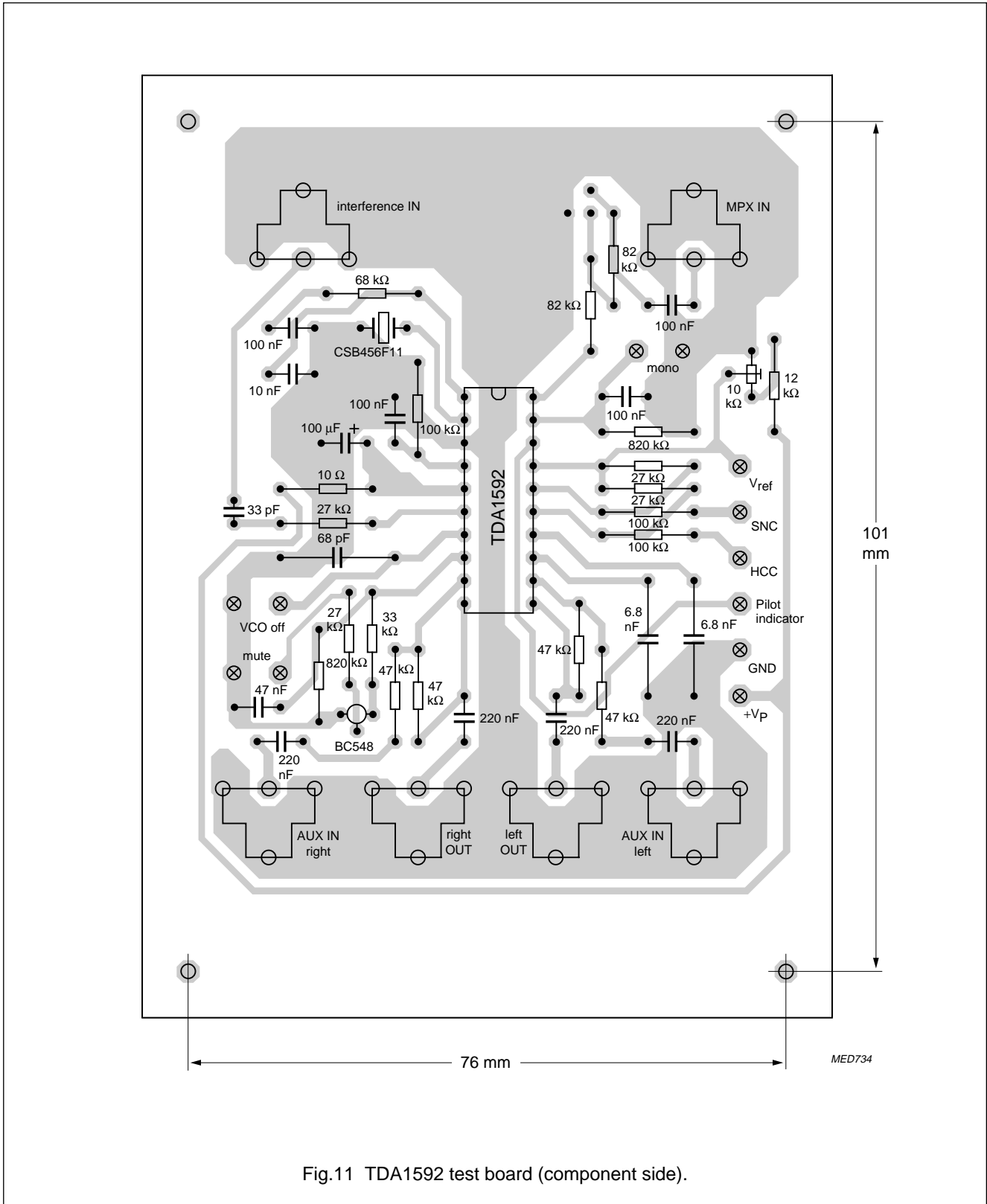

Fig.11 TDA1592 test board (component side).

PLL stereo decoder and noise blanker

TDA1592

PACKAGE OUTLINES

DIP20: plastic dual in-line package; 20 leads (300 mil)

SOT146-1

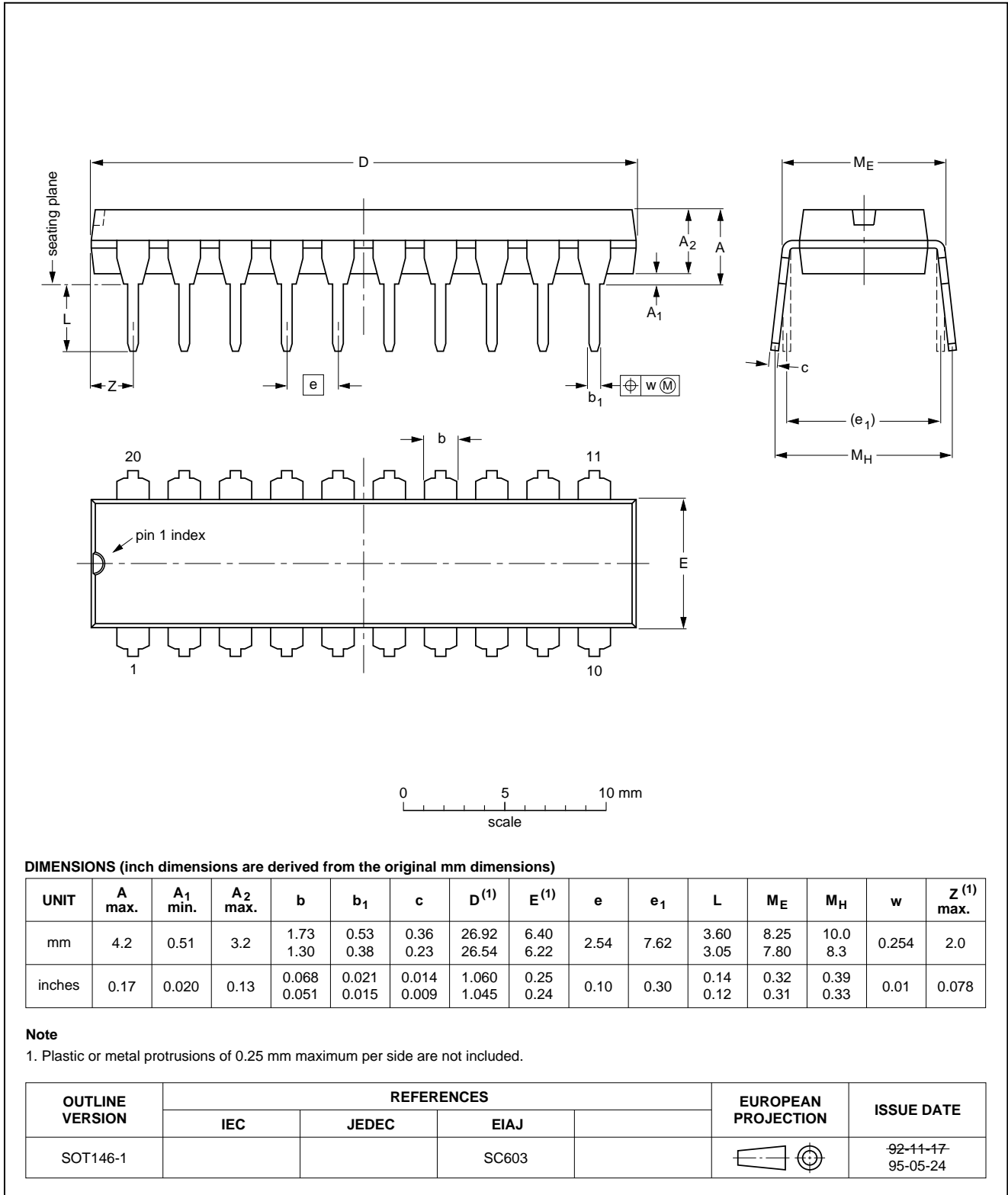

PLL stereo decoder and noise blanker

TDA1592

SO20: plastic small outline package; 20 leads; body width 7.5 mm

SOT163-1

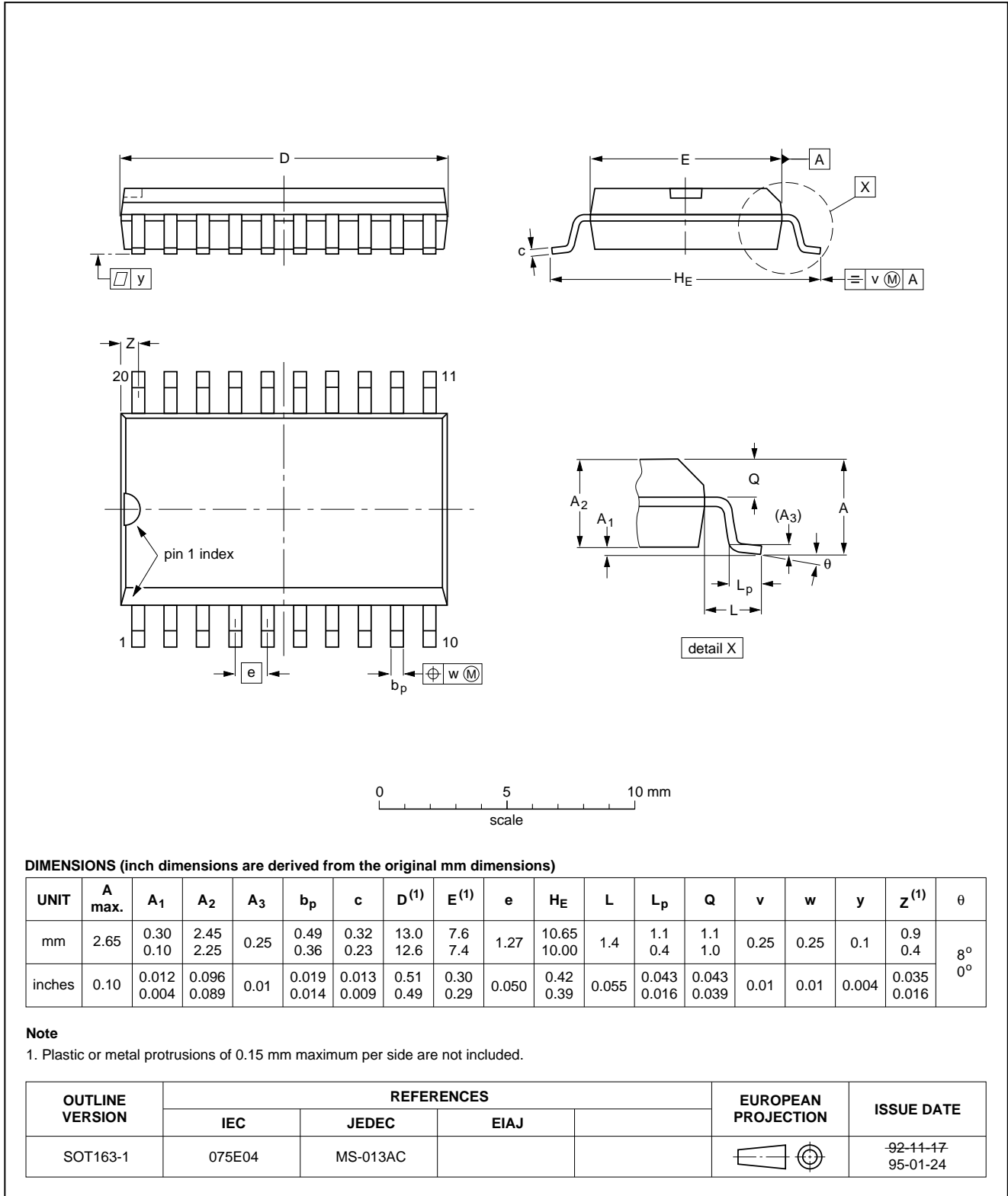

## PLL stereo decoder and noise blanker

TDA1592

### SOLDERING

#### Introduction

There is no soldering method that is ideal for all IC packages. Wave soldering is often preferred when through-hole and surface mounted components are mixed on one printed-circuit board. However, wave soldering is not always suitable for surface mounted ICs, or for printed-circuits with high population densities. In these situations reflow soldering is often used.

This text gives a very brief insight to a complex technology. A more in-depth account of soldering ICs can be found in our "IC Package Databook" (order code 9398 652 90011).

#### DIP

##### SOLDERING BY DIPPING OR BY WAVE

The maximum permissible temperature of the solder is 260 °C; solder at this temperature must not be in contact with the joint for more than 5 seconds. The total contact time of successive solder waves must not exceed 5 seconds.

The device may be mounted up to the seating plane, but the temperature of the plastic body must not exceed the specified maximum storage temperature ( $T_{stg\ max}$ ). If the printed-circuit board has been pre-heated, forced cooling may be necessary immediately after soldering to keep the temperature within the permissible limit.

##### REPAIRING SOLDERED JOINTS

Apply a low voltage soldering iron (less than 24 V) to the lead(s) of the package, below the seating plane or not more than 2 mm above it. If the temperature of the soldering iron bit is less than 300 °C it may remain in contact for up to 10 seconds. If the bit temperature is between 300 and 400 °C, contact may be up to 5 seconds.

#### SO

##### REFLOW SOLDERING

Reflow soldering techniques are suitable for all SO packages.

Reflow soldering requires solder paste (a suspension of fine solder particles, flux and binding agent) to be applied to the printed-circuit board by screen printing, stencilling or pressure-syringe dispensing before package placement.

Several techniques exist for reflowing; for example, thermal conduction by heated belt. Dwell times vary between 50 and 300 seconds depending on heating method. Typical reflow temperatures range from 215 to 250 °C.

Preheating is necessary to dry the paste and evaporate the binding agent. Preheating duration: 45 minutes at 45 °C.

##### WAVE SOLDERING

Wave soldering techniques can be used for all SO packages if the following conditions are observed:

- A double-wave (a turbulent wave with high upward pressure followed by a smooth laminar wave) soldering technique should be used.
- The longitudinal axis of the package footprint must be parallel to the solder flow.
- The package footprint must incorporate solder thieves at the downstream end.

During placement and before soldering, the package must be fixed with a droplet of adhesive. The adhesive can be applied by screen printing, pin transfer or syringe dispensing. The package can be soldered after the adhesive is cured.

Maximum permissible solder temperature is 260 °C, and maximum duration of package immersion in solder is 10 seconds, if cooled to less than 150 °C within 6 seconds. Typical dwell time is 4 seconds at 250 °C.

A mildly-activated flux will eliminate the need for removal of corrosive residues in most applications.

##### REPAIRING SOLDERED JOINTS

Fix the component by first soldering two diagonally-opposite end leads. Use only a low voltage soldering iron (less than 24 V) applied to the flat part of the lead. Contact time must be limited to 10 seconds at up to 300 °C. When using a dedicated tool, all other leads can be soldered in one operation within 2 to 5 seconds between 270 and 320 °C.



## PLL stereo decoder and noise blanker

TDA1592

**DEFINITIONS**

|   |   |
|---|---|
| <b>Data sheet status</b>  |   |
| Objective specification   | This data sheet contains target or goal specifications for product development.       |
| Preliminary specification   | This data sheet contains preliminary data; supplementary data may be published later. |
| Product specification   | This data sheet contains final product specifications.                                |
| <b>Limiting values</b>  |   |
| Limiting values given are in accordance with the Absolute Maximum Rating System (IEC 134). Stress above one or more of the limiting values may cause permanent damage to the device. These are stress ratings only and operation of the device at these or at any other conditions above those given in the Characteristics sections of the specification is not implied. Exposure to limiting values for extended periods may affect device reliability. |   |
| <b>Application information</b>  |   |
| Where application information is given, it is advisory and does not form part of the specification.   |   |

**LIFE SUPPORT APPLICATIONS**

These products are not designed for use in life support appliances, devices, or systems where malfunction of these products can reasonably be expected to result in personal injury. Philips customers using or selling these products for use in such applications do so at their own risk and agree to fully indemnify Philips for any damages resulting from such improper use or sale.

PLL stereo decoder and noise blanker

TDA1592

---

**NOTES**

PLL stereo decoder and noise blanker

TDA1592

---

**NOTES**

# Philips Semiconductors – a worldwide company

**Argentina:** see South America

**Australia:** 34 Waterloo Road, NORTH RYDE, NSW 2113,  
Tel. +61 2 805 4455, Fax. +61 2 805 4466

**Austria:** Computerstr. 6, A-1101 WIEN, P.O. Box 213,  
Tel. +43 1 60 101, Fax. +43 1 60 101 1210

**Belarus:** Hotel Minsk Business Center, Bld. 3, r. 1211, Volodarski Str. 6,  
220050 MINSK, Tel. +375 172 200 733, Fax. +375 172 200 773

**Belgium:** see The Netherlands

**Brazil:** see South America

**Bulgaria:** Philips Bulgaria Ltd., Energoproject, 15th floor,  
51 James Bourchier Blvd., 1407 SOFIA,  
Tel. +359 2 689 211, Fax. +359 2 689 102

**Canada:** PHILIPS SEMICONDUCTORS/COMPONENTS,  
Tel. +1 800 234 7381, Fax. +1 708 296 8556

**China/Hong Kong:** 501 Hong Kong Industrial Technology Centre,  
72 Tat Chee Avenue, Kowloon Tong, HONG KONG,  
Tel. +852 2319 7888, Fax. +852 2319 7700

**Colombia:** see South America

**Czech Republic:** see Austria

**Denmark:** Prags Boulevard 80, PB 1919, DK-2300 COPENHAGEN S,  
Tel. +45 32 88 2636, Fax. +45 31 57 1949

**Finland:** Sinikalliontie 3, FIN-02630 ESPOO,  
Tel. +358 615 800, Fax. +358 615 80920

**France:** 4 Rue du Port-aux-Vins, BP317, 92156 SURESNES Cedex,  
Tel. +33 1 40 99 6161, Fax. +33 1 40 99 6427

**Germany:** Hammerbrookstraße 69, D-20097 HAMBURG,  
Tel. +49 40 23 52 60, Fax. +49 40 23 536 300

**Greece:** No. 15, 25th March Street, GR 17778 TAVROS,  
Tel. +30 1 4894 339/911, Fax. +30 1 4814 240

**Hungary:** see Austria

**India:** Philips INDIA Ltd, Shivsagar Estate, A Block, Dr. Annie Besant Rd.  
Worli, MUMBAI 400 018, Tel. +91 22 4938 541, Fax. +91 22 4938 722

**Indonesia:** see Singapore

**Ireland:** Newstead, Clonskeagh, DUBLIN 14,  
Tel. +353 1 7640 000, Fax. +353 1 7640 200

**Israel:** RAPAC Electronics, 7 Kehilat Saloniki St, TEL AVIV 61180,  
Tel. +972 3 645 0444, Fax. +972 3 648 1007

**Italy:** PHILIPS SEMICONDUCTORS, Piazza IV Novembre 3,  
20124 MILANO, Tel. +39 2 6752 2531, Fax. +39 2 6752 2557

**Japan:** Philips Bldg 13-37, Kohnan 2-chome, Minato-ku, TOKYO 108,  
Tel. +81 3 3740 5130, Fax. +81 3 3740 5077

**Korea:** Philips House, 260-199 Itaewon-dong, Yongsan-ku, SEOUL,  
Tel. +82 2 709 1412, Fax. +82 2 709 1415

**Malaysia:** No. 76 Jalan Universiti, 46200 PETALING JAYA, SELANGOR,  
Tel. +60 3 750 5214, Fax. +60 3 757 4880

**Mexico:** 5900 Gateway East, Suite 200, EL PASO, TEXAS 79905,  
Tel. +1 800 234 7381, Fax. +1 708 296 8556

**Middle East:** see Italy

**Netherlands:** Postbus 90050, 5600 PB EINDHOVEN, Bldg. VB,  
Tel. +31 40 27 83749, Fax. +31 40 27 88399

**New Zealand:** 2 Wagener Place, C.P.O. Box 1041, AUCKLAND,  
Tel. +64 9 849 4160, Fax. +64 9 849 7811

**Norway:** Box 1, Manglerud 0612, OSLO,  
Tel. +47 22 74 8000, Fax. +47 22 74 8341

**Philippines:** Philips Semiconductors Philippines Inc.,  
106 Valero St. Salcedo Village, P.O. Box 2108 MCC, MAKATI,  
Metro MANILA, Tel. +63 2 816 6380, Fax. +63 2 817 3474

**Poland:** Ul. Lukiska 10, PL 04-123 WARSZAWA,  
Tel. +48 22 612 2831, Fax. +48 22 612 2327

**Portugal:** see Spain

**Romania:** see Italy

**Russia:** Philips Russia, Ul. Usatcheva 35A, 119048 MOSCOW,  
Tel. +7 095 926 5361, Fax. +7 095 564 8323

**Singapore:** Lorong 1, Toa Payoh, SINGAPORE 1231,  
Tel. +65 350 2538, Fax. +65 251 6500

**Slovakia:** see Austria

**Slovenia:** see Italy

**South Africa:** S.A. PHILIPS Pty Ltd., 195-215 Main Road Martindale,  
2092 JOHANNESBURG, P.O. Box 7430 Johannesburg 2000,  
Tel. +27 11 470 5911, Fax. +27 11 470 5494

**South America:** Rua do Rocio 220 - 5th floor, Suite 51,  
CEP: 04552-903-SÃO PAULO-SP, Brazil, P.O. Box 7383 (01064-970),  
Tel. +55 11 821 2333, Fax. +55 11 829 1849

**Spain:** Balmes 22, 08007 BARCELONA,  
Tel. +34 3 301 6312, Fax. +34 3 301 4107

**Sweden:** Kottbygatan 7, Akalla, S-16485 STOCKHOLM,  
Tel. +46 8 632 2000, Fax. +46 8 632 2745

**Switzerland:** Allmendstrasse 140, CH-8027 ZÜRICH,  
Tel. +41 1 488 2686, Fax. +41 1 481 7730

**Taiwan:** PHILIPS TAIWAN Ltd., 23-30F, 66,  
Chung Hsiao West Road, Sec. 1, P.O. Box 22978,  
TAIPEI 100, Tel. +886 2 382 4443, Fax. +886 2 382 4444

**Thailand:** PHILIPS ELECTRONICS (THAILAND) Ltd.,  
209/2 Sanpavuth-Bangna Road Prakanong, BANGKOK 10260,  
Tel. +66 2 745 4090, Fax. +66 2 398 0793

**Turkey:** Talatpasa Cad. No. 5, 80640 GÜLTEPE/ISTANBUL,  
Tel. +90 212 279 2770, Fax. +90 212 282 6707

**Ukraine:** PHILIPS UKRAINE, 2A Akademika Koroleva str., Office 165,  
252148 KIEV, Tel. +380 44 476 0297/1642, Fax. +380 44 476 6991

**United Kingdom:** Philips Semiconductors Ltd., 276 Bath Road, Hayes,  
MIDDLESEX UB3 5BX, Tel. +44 181 730 5000, Fax. +44 181 754 8421

**United States:** 811 East Arques Avenue, SUNNYVALE, CA 94088-3409,  
Tel. +1 800 234 7381, Fax. +1 708 296 8556

**Uruguay:** see South America

**Vietnam:** see Singapore

**Yugoslavia:** PHILIPS, Trg N. Pasica 5/v, 11000 BEOGRAD,  
Tel. +381 11 825 344, Fax. +381 11 635 777

**For all other countries apply to:** Philips Semiconductors, Marketing & Sales Communications, Building BE-p, P.O. Box 218, 5600 MD EINDHOVEN, The Netherlands, Fax. +31 40 27 24825

**Internet:** <http://www.semiconductors.philips.com/ps/>

© Philips Electronics N.V. 1996

SCA49

All rights are reserved. Reproduction in whole or in part is prohibited without the prior written consent of the copyright owner.

The information presented in this document does not form part of any quotation or contract, is believed to be accurate and reliable and may be changed without notice. No liability will be accepted by the publisher for any consequence of its use. Publication thereof does not convey nor imply any license under patent- or other industrial or intellectual property rights.

Printed in The Netherlands

517021/1200/02/pp20

Date of release: 1996 May 31

Document order number: 9397 750 00875

*Let's make things better.*

**Philips  
Semiconductors**



**PHILIPS**