

TOSHIBA CMOS DIGITAL INTEGRATED CIRCUIT SILICON MONOLITHIC

TC9452F

SINGLE CHIP SURROUND LSI

TC9452F is single chip Surround LSI for portable equipment, Mini compo.
As built-in ADC/DAC, Surround, Digital equalizer, compressor, bass treble and stereo wide, this IC constructs DSP function.

FEATURES

- Built-in 3channel AD converter.
THD : -65dB S/N : 78dB (typ.)
Built-in Ope Amp for Pre-filter.
- Built-in 2channel DA converter.
THD : -85dB S/N : 93dB (typ.)
Built-in 3rd Analog filter.
- Input : 3 Analog channel, 1 Digital stereo port.
Digital Input format : MSB first 16, 18, 20bit effective data before change point of LRCK or I²S.
- Output : 2 Analog Output / 1 Digital stereo port.
Digital Output format : MSB first 16, 20bit effective data before change point of LRCK or I²S.
- Built-in 64Kbit delay RAM.
- DSP function
 - Surround : Real Surround to use delay, simulate sound field of Hole, Church, Stadium and etc.
 - Compressor or Bass boost : Dynamic Surround to respond an input
 - 2 Band Parametric Equalizer : Equalizer of a high precision of 18bit coefficient
 - Stereo wide : Emphasis of stereo source
 - Pseudo stereo : Like a stereo of monorail source
 - Mic echo : 1 of 3 ADC inputs is used for this function
 - Vocal cancel : Suppress vocal signal from stereo source
- Package is QFP 44pins.

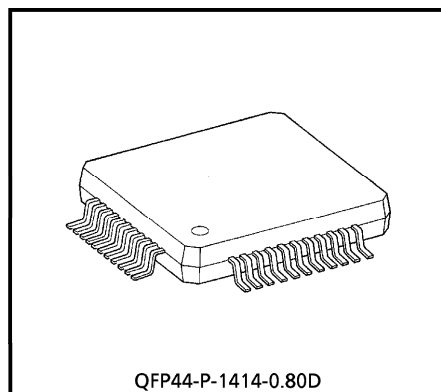

Weight : 1.07g (Typ.)

980508EBA2

● TOSHIBA is continually working to improve the quality and the reliability of its products. Nevertheless, semiconductor devices in general can malfunction or fail due to their inherent electrical sensitivity and vulnerability to physical stress. It is the responsibility of the buyer, when utilizing TOSHIBA products, to observe standards of safety, and to avoid situations in which a malfunction or failure of a TOSHIBA product could cause loss of human life, bodily injury or damage to property. In developing your designs, please ensure that TOSHIBA products are used within specified operating ranges as set forth in the most recent products specifications. Also, please keep in mind the precautions and conditions set forth in the TOSHIBA Semiconductor Reliability Handbook.

● The products described in this document are subject to foreign exchange and foreign trade laws.
 ● The information contained herein is presented only as a guide for the applications of our products. No responsibility is assumed by TOSHIBA CORPORATION for any infringements of intellectual property or other rights of the third parties which may result from its use. No license is granted by implication or otherwise under any intellectual property or other rights of TOSHIBA CORPORATION or others.
 ● The information contained herein is subject to change without notice.

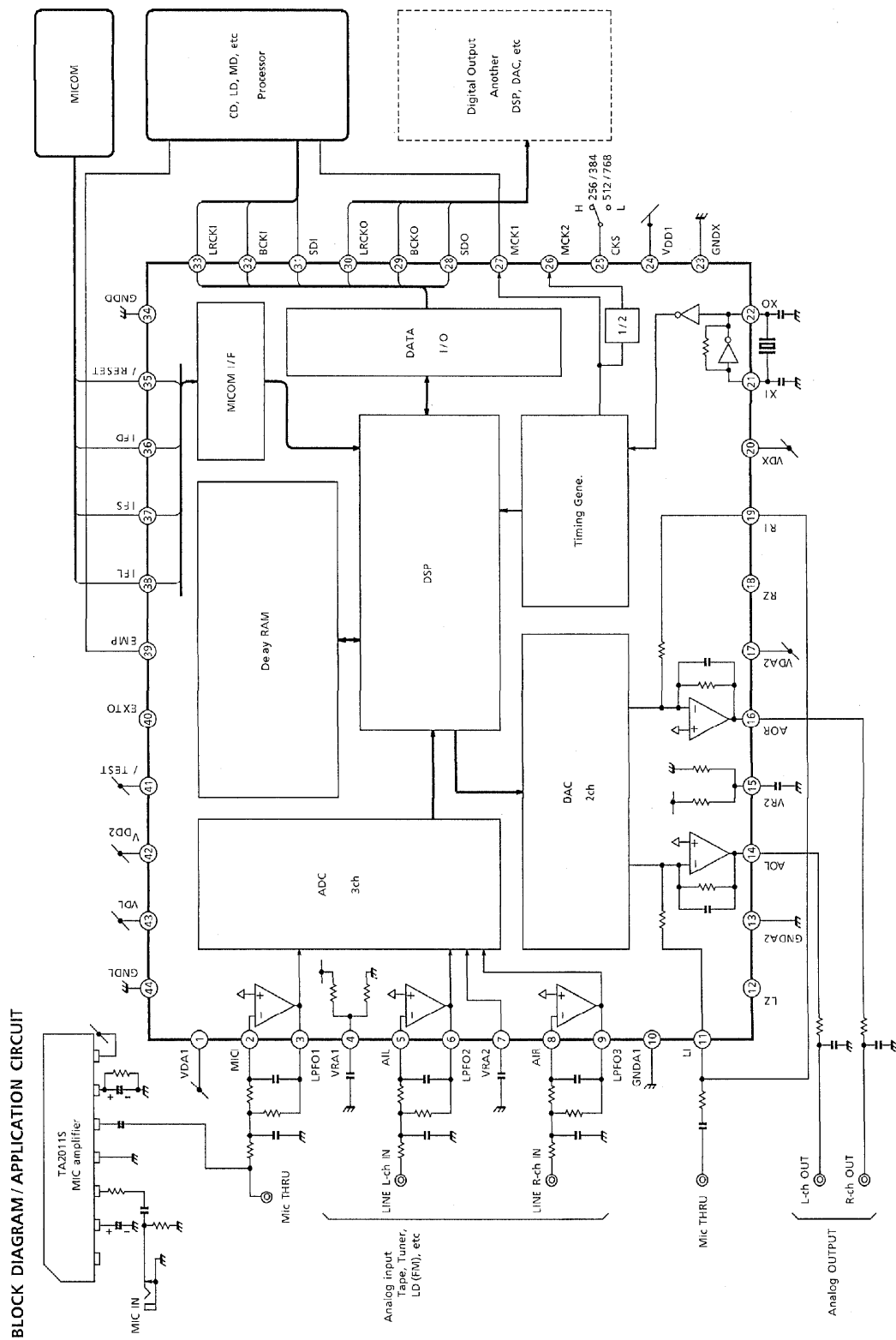

TC9452F - 2

TERMINAL DESCRIPTION

No.	TERMINAL	I/O	FUNCTION	REMARK
1	VDA1	—	ADC Voltage supply terminal.	
2	MICI	I	MIC LPF input terminal.	
3	LPFO1	O	MIC LPF output terminal.	
4	VRA1	—	ADC reference voltage terminal.	
5	AIL	I	LPF input terminal for L-ch Line input.	
6	LPFO2	O	LPF output terminal for L-ch Line input.	
7	VRA2	—	ADC reference voltage terminal.	
8	AIR	I	LPF input terminal for R-ch Line input.	
9	LPFO3	O	LPF output terminal for L-ch Line input.	
10	GNDA1	—	ADC GND terminal.	
11	LI	I	L-ch Analog additional input terminal. (When not using : OPEN)	
12	LZ	O	L-ch Digital input 0 detect terminal.	
13	GNDA2	—	DAC GND terminal.	
14	AOL	O	L-ch DAC output terminal.	
15	VR2	—	DAC reference voltage terminal.	
16	AOR	O	R-ch DAC output terminal.	
17	VDA2	—	DAC voltage supply terminal.	
18	RZ	O	R-ch Digital input 0 detect terminal.	
19	RI	I	R-ch Analog additional input terminal. (When not using : OPEN)	
20	VDX	—	Crystal oscillator voltage supply terminal.	
21	XI	I	Crystal oscillator connection terminal. (256, 384, 512, 768fs)	
22	XO	O	Crystal oscillator connection terminal.	
23	GNDX	—	Crystal oscillator GND terminal.	
24	VDD1	—	Digital voltage supply terminal.	
25	CKS	I	Master clock select terminal. ("H" : 256/384fs, "L" : 512/768fs)	
26	MCK2	O	1/2 divider clock output terminal.	
27	MCK1	O	Oscillator clock output terminal.	
28	SDO	O	Digital Audio Data output terminal.	
29	BCKO	O	Bit clock output terminal.	
30	LRCKO	O	Channel clock output terminal.	
31	SDI	I	Digital Audio Data input terminal.	
32	BCKI	I	Bit clock input terminal.	
33	LRCKI	I	Channel clock input terminal.	
34	GNDD	—	Digital GND terminal.	
35	RESET	I	Reset terminal. ("L" Reset active)	pull-up resistor
36	IFD	I	μ -COM I/F data input terminal.	
37	IFS	I	μ -COM I/F data shift clock input terminal.	
38	IFL	I	μ -COM I/F latch pulse input terminal.	

No.	TERMINAL	I/O	FUNCTION	REMARK
39	EMP	I	De-emphasis filter setting terminal. ("H" : De-emphasis filter ON)	
40	EXTO	O	Extend output terminal.	
41	TEST	I	Test terminal. Usually "H"	pull-up resistor
42	V _{DD2}	—	Digital Voltage supply terminal.	
43	V _{DL}	—	Digital Voltage supply terminal for DRAM.	
44	GNDL	—	Digital GND terminal for DRAM.	

Block operating description

1. Operating Clock

Master clock (Input or oscillating XI terminal) is 768/512/384/256fs. These mode are selected by CKS terminal, and 256fs or 384fs, 768fs or 512fs select is auto detect by this IC.

But following internal synchronize mode can not use 384/768fs, can only use 256/512fs.

And DSP calculate steps don't concern master clock, but DA converter operating clock change by master clock. DAC is Σ - Δ modulation method and operates oversampling, If 256fs is selected, Oversampling ratio is 128fs and so became worse S/N, THD + N.

Table.1-1 Master clock select and DAC oversampling ratio.

CKS	MASTER CLOCK	DAC OVERSAMPLING RATIO
L	768fs	192fs
	512fs	256fs
H	384fs	192fs
	256fs	128fs

2. Digital Audio Input/Output

2.1 Synchronize mode

Data input/output Bit clock is selected internal synchronize or external synchronize by "SYNM1", "SYNM2". (μ -COM I/F bit)

Table.2-1-1 Synchronize mode and Input/Output Bit clock.

SYNM2	SYNM1	SYNCHRONIZE	BCKI	BCKO
0	0	internal	(*)	64fs (**)
0	1	external	32fs	BCKI
1	0	external	48fs	BCKI
1	1	external	64fs	BCKI

(*) Table 2-2-1 shown.

(**) Internal clock divider.

Input/Output channel clock (LRCKI, LRCKO) data is selected by μ -COM I/F. (RLS bit)

Table.2-1-2 Channel clock

RLS	OPERATE
0	LRCKI, LRCKO : "H" Level, L-ch data input/output
1	LRCKI, LRCKO : "L" Level, L-ch data input/output

2.2 Data Input format

Data input format is Table.2-2-1 and Fig.1.

Selecting use IBIT1 and IBIT2. (μ -COM I/F)

Table.2-2-1 Data input format

SYNM2	SYNM1	IBIT2	IBIT1		FORMAT	BCKI
0	0	0	0	INTERNAL SYNCHRONIZE	MSBfirst 16bit	32fs~128fs
0	0	0	1		MSBfirst 18bit	36fs~128fs
0	0	1	0		MSBfirst 20bit	40fs~128fs
0	0	1	1		IIS MAX20bit	64fs only
0	1	0	0	EXTERNAL SYNCHRONIZE	MSBfirst 16bit	32fs
0	1	0	1		not use	32fs
0	1	1	0		not use	32fs
0	1	1	1		not use	32fs
1	0	0	0		MSBfirst 16bit	48fs
1	0	0	1		MSBfirst 18bit	48fs
1	0	1	0		MSBfirst 20bit	48fs
1	0	1	1		not use	48fs
1	1	0	0		MSBfirst 16bit	64fs
1	1	0	1		MSBfirst 18bit	64fs
1	1	1	0		MSBfirst 20bit	64fs
1	1	1	1		IIS MAX20bit	64fs

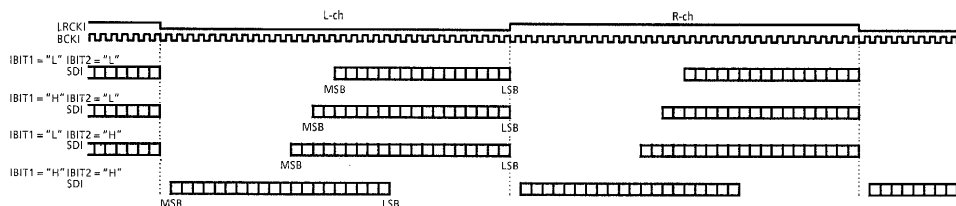

Fig.1 Example Data input timing (RLS = "H", SYNM1 = "H", SYNM2 = "H")

2.3 Digital Zero detect function

Table.2-3-1 Digital Zero detect judge time

fs	32kHz	44.1kHz	48kHz
Judge Time	1024ms	743ms	683ms

2.4 Stereo/Mono setting

This IC can input Double music source by "MONO", "CHS" bit. (μ -COM I/F)
 And this IC can input Double music source by software coefficient, too. Please show Program manual.

Table.2-4-1 Stereo/Mono setting

MONO	CHS	STEREO/MONO
0	0	stereo
0	1	ZERO Detect not use ("L" output only)
1	0	L-ch (CH1) MONO OUTPUT
1	1	R-ch (CH2) MONO OUTPUT

2.5 Data output formats

Table.2-5-1 Data Output formats

SYNM2	SYNM1	OBIT2	OBIT1		FORMAT	BCKO
0	0	0	0	INTERNAL SYNCHRONIZE	MSBfirst 16bit	64fs
0	0	0	1		MSBfirst 20bit	64fs
0	0	1	0		IIS 16bit	64fs
0	0	1	1		IIS 20bit	64fs
0	1	0	0	EXTERNAL SYNCHRONIZE	MSBfirst 16bit	32fs (= BCKI)
0	1	0	1		not use	32fs (= BCKI)
0	1	1	0		IIS 16bit	32fs (= BCKI)
0	1	1	1		not use	32fs (= BCKI)
1	0	0	0		MSBfirst 16bit	48fs (= BCKI)
1	0	0	1		MSBfirst 20bit	48fs (= BCKI)
1	0	1	0		IIS 16bit	48fs (= BCKI)
1	0	1	1		IIS 20bit	48fs (= BCKI)
1	1	0	0		MSBfirst 16bit	64fs (= BCKI)
1	1	0	1		MSBfirst 20bit	64fs (= BCKI)
1	1	1	0	IIS 16bit	64fs (= BCKI)	
1	1	1	1	IIS 20bit	64fs (= BCKI)	

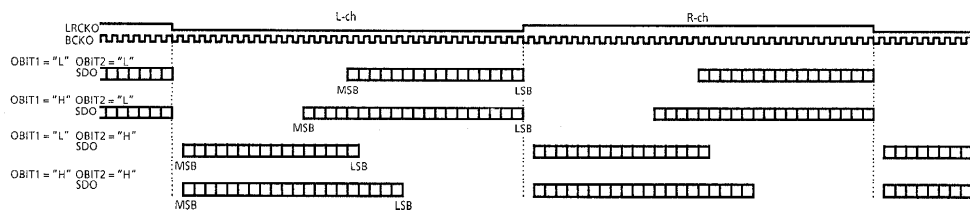

Fig.2 Example Data Output Timing (RLS = "H", SYNM1 = "H", SYNM2 = "H")

3. μ -COM I/F

3.1 Setting

μ -COM I/F setting is 4 Items.

Command is variable length 16~26bits. (effective data before change point Latch pulse)

When command is 8bits unit, setting is LSB first.

All this IC's setting change at internal program cycle beginning, but without digital attenuator setting, please mute output signal at changing program setting.

So Coefficient setting and offset RAM writing is one word at a fs.

When many word change, please by careful.

Table.3-1-1 μ -COM I/F setting

	MODE	FUNC.	ATT.	CRAM	
D25	0	0	0	1	
D24	0	0	1	AD6	
D23	1	1	AL13	AD5	
D22	0	1	AL12	AD4	
D21	CHS	EMS	AL11	AD3	
D20	MONO	EM2	AL10	AD2	
D19	OBIT2	EM1	AL09	AD1	
D18	OBIT1	CEF2	AL08	AD0	1byte
D17	IBIT2	CEF1	AL07	DT17	
D16	IBIT1	CTDW	AL06	DT16	
D15	SYNM2	CTUP	AL05	DT15	
D14	SYNM1	MUTE	AL04	DT14	
D13	RLS	EXTO	AL03	DT13	
D12	LSM	BB	AL02	DT12	
D11	RESERVED	DF2	AL01	DT11	
D10	ADPD	DF1	AL00	DT10	2byte
D09	—	—	—	DT09	
D08	—	—	—	DT08	
D07	—	—	—	DT07	
D06	—	—	—	DT06	
D05	—	—	—	DT05	
D04	—	—	—	DT04	
D03	—	—	—	DT03	
D02	—	—	—	DT02	3byte
D01	—	—	—	DT01	
D00	—	—	—	DT00	

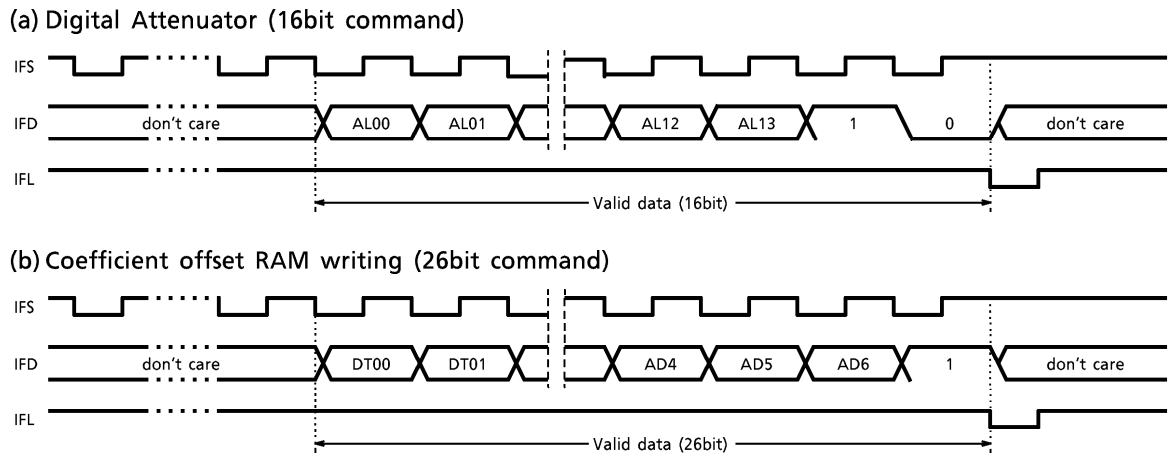

Fig.3 Example μ -COM I/F

3.2 Operating mode setting [MODE]

Please set these mode at voltage supply.

When $\overline{\text{RESET}}$ is "L", these data is clear.

- ADPD : ADC power down (H : power down)
- RESERVED : "L"
- LSM : Digital Attenuator soft mute time select ("H" : twice)
- RLS : Channel clock select (H : LRCK = "L" is L-ch data)
- SYNM1, 2 : DATA input/output synchronize clock select
- IBIT1, 2 : Input DATA format select
- OBIT1, 2 : Output DATA format select
- MONO : MONO DATA input select
- CHS : At MONO Setting, channel select, At stereo setting, zero detect setting

3.3 DSP setting [FUNC]

At $\overline{\text{RESET}}$ terminal is "L" level, these data is clear.

- DF1, 2 : SFC, Mic echo desimtion ratio select
- BB : Compressor/Bass Boost filter select ("H" : Bass Boost filter)
- EXTO : Expand output terminal OUTPUT DATA
- MUTE : OUTPUT mute ("H" : mute, ATT setting is hold)
- CTUP : Compressor attack time select
- CTDW : Compressor release time select
- CEF1 : Compressor/Bass Boost select ("H" : Bass Boost)
- CEF2 : Compressor/Bass Boost effect select ("H" : Large effect)
- EM1, 2 : De-emphasis filter select
- EMS : De-emphasis filter block select

Table.3-3-1 De-emphasis setting

TERMINAL	I / F SETTING				FUNCTION
	EMP	EMS	EM2		
0	0	—	—	DIGITAL INPUT	OFF
1	0	0	0		de-emphasis 1 44.1kHz
1	0	0	1		OFF
1	0	1	0		de-emphasis 1 48kHz
1	0	1	1		de-emphasis 1 32kHz
0	1	—	—	DAC DF	OFF
1	1	0	0		de-emphasis 2 44.1kHz
1	1	0	1		OFF
1	1	1	0		de-emphasis 2 48kHz
1	1	1	1		de-emphasis 2 32kHz

3.4 Digital Attenuator Setting [ATT]

Table.3-4-1 Digital Attenuator level setting

AL [13 : 00]	OUTPUT LEVEL
3FFFH	- 0.000dB
3FFDH	- 0.001dB
3FFBH	- 0.002dB
...	...
2D4EH	- 3.000dB
...	...
2013H	- 6.000dB
...	...
0002H	- 78.268dB
0001H	- 84.288dB
0000H	- ∞ dB

[Level setting]

$$AL [13 : 00] = 3FFFH * 10^{-(LEVEL / 20)}$$

Table.3-4-2 Digital Attenuator mute time

LSM	32kHz	44.1kHz	48kHz
0	32ms	23ms	21ms
1	64ms	46ms	42ms

0dB (3FFFH) ~ - ∞ dB (0000H) Changing Time

3.5 Coefficient, Offset RAM writing [CRAM]

Coefficient and offset RAM writing operate one word at a fs.

RAM is 128word x 18bit.

Delay RAM Address offset data format is as follows.

Detail setting, please show soft ware manual.

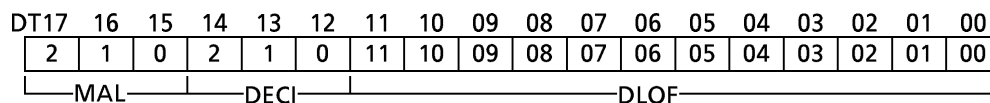

MAL [2 : 0] : Delay RAM setting select

DECI [2 : 0] : Decimation ratio select

DLOF [11 : 00] : Offset Address select

Fig.4 Coefficient, Offset RAM, Offset Address Setting

4. AD converter

Built-in Line input L-ch and R-ch AD converter, and Mic signal input AD converter.

Mic input signal convert Digital signal and DSP make digital echo signal.

Mic signal add this echo signal by LI, RI terminal or external Op-amp.

It is necessary to open LI and RI terminal at the using Op-amp.

When not using AD converter, please short-circuit interval each terminal MICI-LPFO1, AIL-LPFO2 and AIR-LPFO3

5. DA converter

This is $\Sigma\text{-}\Delta$ modulation 1bit DA converter.

Built-in 3'rd Analog Filter.

It is possible to add analog through signal (LI and RI terminal) at the output portion of DAC.

6. Timing

6.1 Reset Timing

At power supply, please set $\overline{\text{RESET}}$ terminal "L" level at one time.

Power ON Reset Timing is as follows.

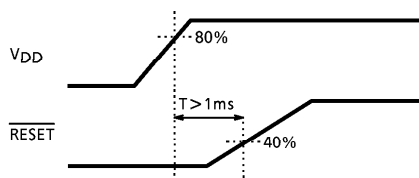

Fig.5 Power on Reset Timing

6.2 $\mu\text{-COM}$ I/F Timing

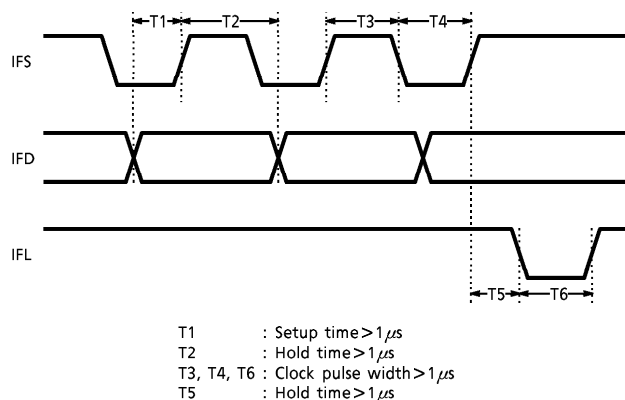

Fig.6 $\mu\text{-COM}$ I/F Timing

MAXIMUM RATINGS

CHARACTERISTIC	SYMBOL	RATING	UNIT
Supply Voltage	V_{DD}	-0.3~6.0	V
Input Voltage	V_{in}	-0.3~ $V_{DD} + 0.3$	V
Power Dissipation	P_D	500	mW
Operating Temperature	T_{opr}	-40~85	°C
Storage Temperature	T_{stg}	-55~150	°C

ELECTRICAL CHARACTERISTICS (DC)

CHARACTERISTIC	SYMBOL	TEST CIRCUIT	TEST CONDITION	MIN.	TYP.	MAX.	UNIT
Operating Supply Voltage	V_{DD}	—	$T_a = -40\sim 85^\circ\text{C}$	4.5	5.0	5.5	V
Power Supply Current	I_{DD}	—	$XI = 16.9\text{MHz}$, Output No-load	—	48	70	mA
Input Voltage	"H" Level	V_{IH}	Digital input terminal	$V_{DD} \times 0.8$	—	V_{DD}	V
	"L" Level	V_{IL}		0	—	$V_{DD} \times 0.2$	
Input Current	"H" Level	I_{IH}	Digital input terminal	—	—	1.0	μA
	"L" Level	I_{IL}		-1.0	—	—	
Output Current 1	"H" Level	I_{OH1}	LRCKO, BCKO, SDO	-3.5	—	—	mA
	"L" Level	I_{OL1}		—	—	2.0	
Output Current 2	"H" Level	I_{OH2}	MCK1, MCK2	-5.0	—	—	mA
	"L" Level	I_{OL2}		—	—	3.0	
Output Current 3	"H" Level	I_{OH3}	EXTO	-2.0	—	—	mA
	"L" Level	I_{OL3}		—	—	2.0	
Pull-up Resistance	RUP	—	$\overline{\text{RESET}}$, $\overline{\text{TEST}}$	—	50	—	$\text{k}\Omega$

ELECTRICAL CHARACTERISTICS (AC)

AD converter

CHARACTERISTIC	SYMBOL	TEST CIR-CUIT	TEST CONDITION	MIN.	TYP.	MAX.	UNIT
Maximum Input Level	Ain	—	V _{DD} = 5.0V	—	1.1	—	V _{rms}
S / (N + D) Ratio	S / N (AD)	—	- 30dB 1kHz Sine wave input (*)	68	78	—	dB
Total Harmonic Distortion + Noise	THD (AD)	—	- 0dB 1kHz Sine wave input	—	- 65	- 55	dB
Cross-talk	CT (AD)	—	—	—	- 68	- 60	dB

(*) A-Weight : ON (Typ.)

DA converter

CHARACTERISTIC	SYMBOL	TEST CIR-CUIT	TEST CONDITION	MIN.	TYP.	MAX.	UNIT
Output Level	Aout	—	—	—	1.2	—	V _{rms}
S / N Ratio	S / N (DA)	—	- 0dB 1kHz Sine wave input	87	93	—	dB
Total Harmonic Distortion + Noise	THD1 (DA)	—	- 0dB 1kHz Sine wave input	—	- 83	- 78	dB
	THD2 (DA)	—	- 0dB 10kHz Sine wave input	—	- 83	- 75	
Cross-talk	CT (DA)	—	—	—	- 88	- 83	dB

Timing

CHARACTERISTIC	SYMBOL	TEST CIR-CUIT	TEST CONDITION	MIN.	TYP.	MAX.	UNIT
Rise Time	t_r	—	LRCKO, BCKO, SDO, EXTO	—	—	15	ns
		—	MCK1, MCK2	—	—	8	
Fall Time	t_f	—	LRCKO, BCKO, SDO, EXTO	—	—	15	
		—	MCK1, MCK2	—	—	8	
Delay Time	t_d	—	LRCKI→LRCKO (External clock synchronous)	—	—	30	
		—	BCKI→BCKO (External clock synchronous)	—	—	20	
		—	BCKO→SDO	—	—	10	
		—	MCK1→LRCKO (Internal clock synchronous)	—	—	50	
		—	MCK1→BCKO (Internal clock synchronous)	—	—	20	
Operating Frequency	f_{opr}	—	XI = 256fs	8.0	11.3	12.5	MHz
		—	XI = 384fs	10.0	16.9	18.5	
		—	XI = 512fs	16.0	22.6	25.5	
		—	XI = 768fs	24.0	33.9	34.0	

(Note 1) At the external clock synchronous, LRCKO and BCKO output signal are same as LRCKI and BCKI input signal.

At the internal clock synchronous, LRCKO and BCKO output signal are output synchronously with the falling edge of MCK1.

(Note 2) Measured with the output load $CL = 10pF$.

(Note 3) At the XI clock is 256fs, 384fs and 512fs, it is operated with the $f_s = 32kHz$, 44.1kHz and 48kHz. At the XI clock is 768fs, it is operated with the $f_s = 32kHz$ and 44.1kHz.

(Note 4) Delay RAM applications has limitations with the how to control the DRAM. Show the software manual.

AC CHARACTERISTIC POINT (Input signal : LRCK, BCK, DATA)

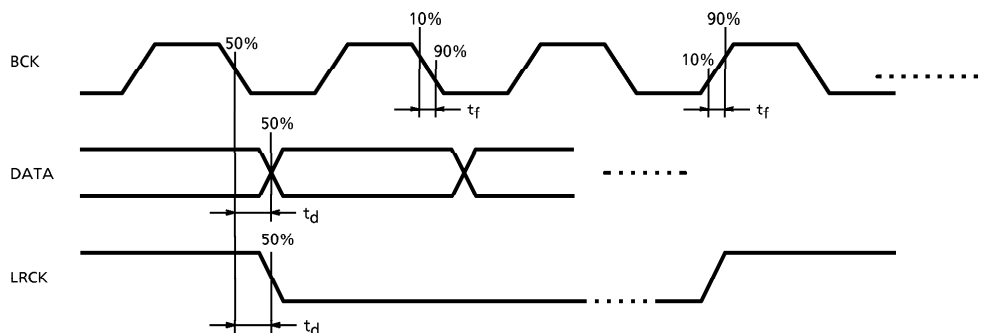

OUTLINE DRAWING
QFP44-P-1414-0.80D

Unit : mm

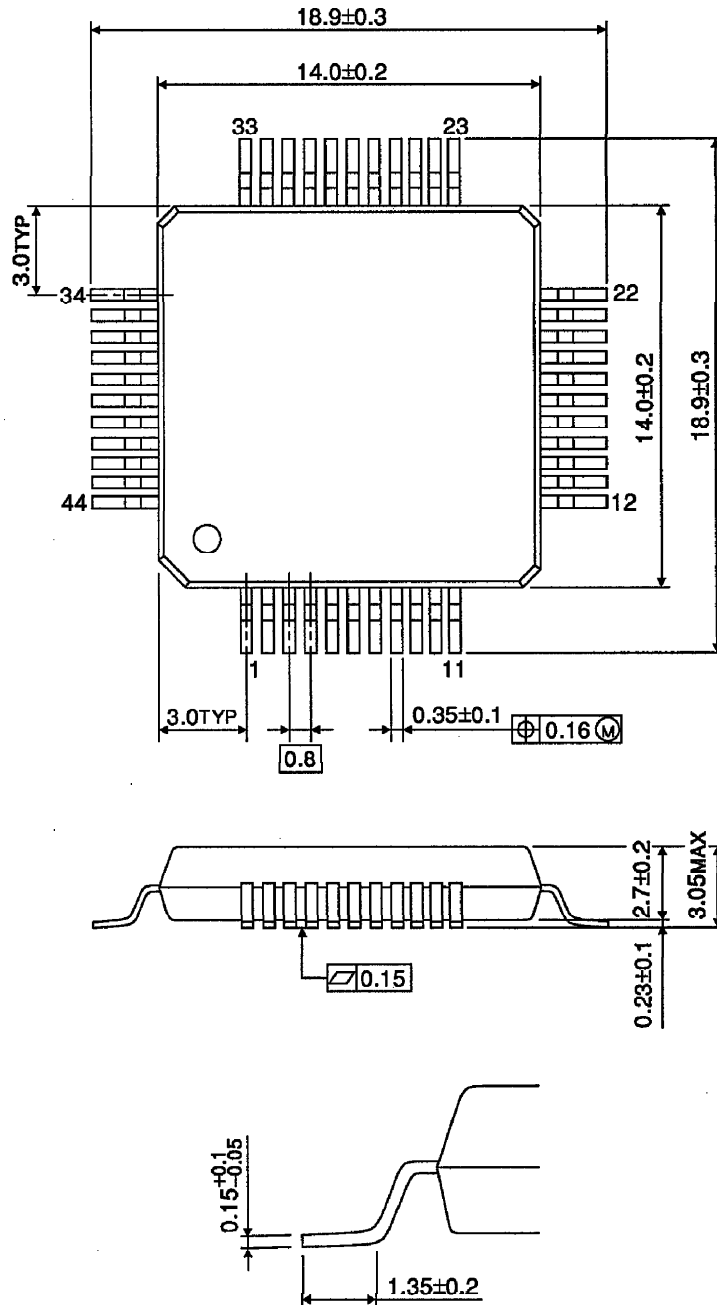

Weight : 1.07g (Typ.)