

TOSHIBA BIPOLAR LINEAR INTEGRATED CIRCUIT SILICON MONOLITHIC

TA2031F**CD FOCUS TRACKING SERVO LSI**

The TA2031F is a 3-beam type PUH compatible focus tracking servo LSI to be used in the CD player system. (Compatible with the Foucault's method focus error detection PUH with generally low focus error detecting sensitivity.)

In combination with a CMOS single chip processor TC9236AF, a CD player system can be composed very simply.

FEATURES

- Built-in RF amp, focus error amp, and tracking error amp.
- Built-in focus tracking servo amp.
- Built-in phase compensation amp and LPF amp.
- Built-in ALPC amp.
- Connections between PUH and power driver IC for motor driver allow simplified structuring of CD player system.
Directly connectable to BTL amp (TA8192F) or PWM driver (TA8460F).

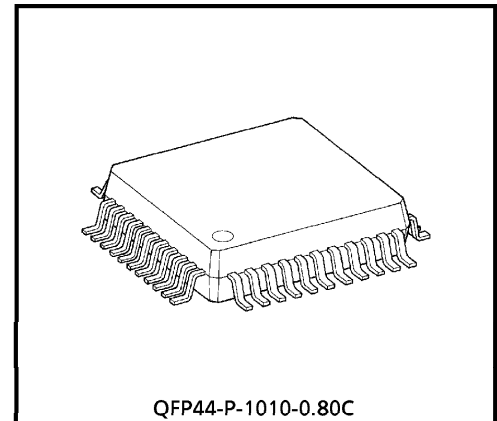

Weight : 0.5g (Typ.)

980910EBA2

- TOSHIBA is continually working to improve the quality and the reliability of its products. Nevertheless, semiconductor devices in general can malfunction or fail due to their inherent electrical sensitivity and vulnerability to physical stress. It is the responsibility of the buyer, when utilizing TOSHIBA products, to observe standards of safety, and to avoid situations in which a malfunction or failure of a TOSHIBA product could cause loss of human life, bodily injury or damage to property. In developing your designs, please ensure that TOSHIBA products are used within specified operating ranges as set forth in the most recent products specifications. Also, please keep in mind the precautions and conditions set forth in the TOSHIBA Semiconductor Reliability Handbook.
- The products described in this document are subject to the foreign exchange and foreign trade laws.
- The information contained herein is presented only as a guide for the applications of our products. No responsibility is assumed by TOSHIBA CORPORATION for any infringements of intellectual property or other rights of the third parties which may result from its use. No license is granted by implication or otherwise under any intellectual property or other rights of TOSHIBA CORPORATION or others.
- The information contained herein is subject to change without notice.

BLOCK DIAGRAM

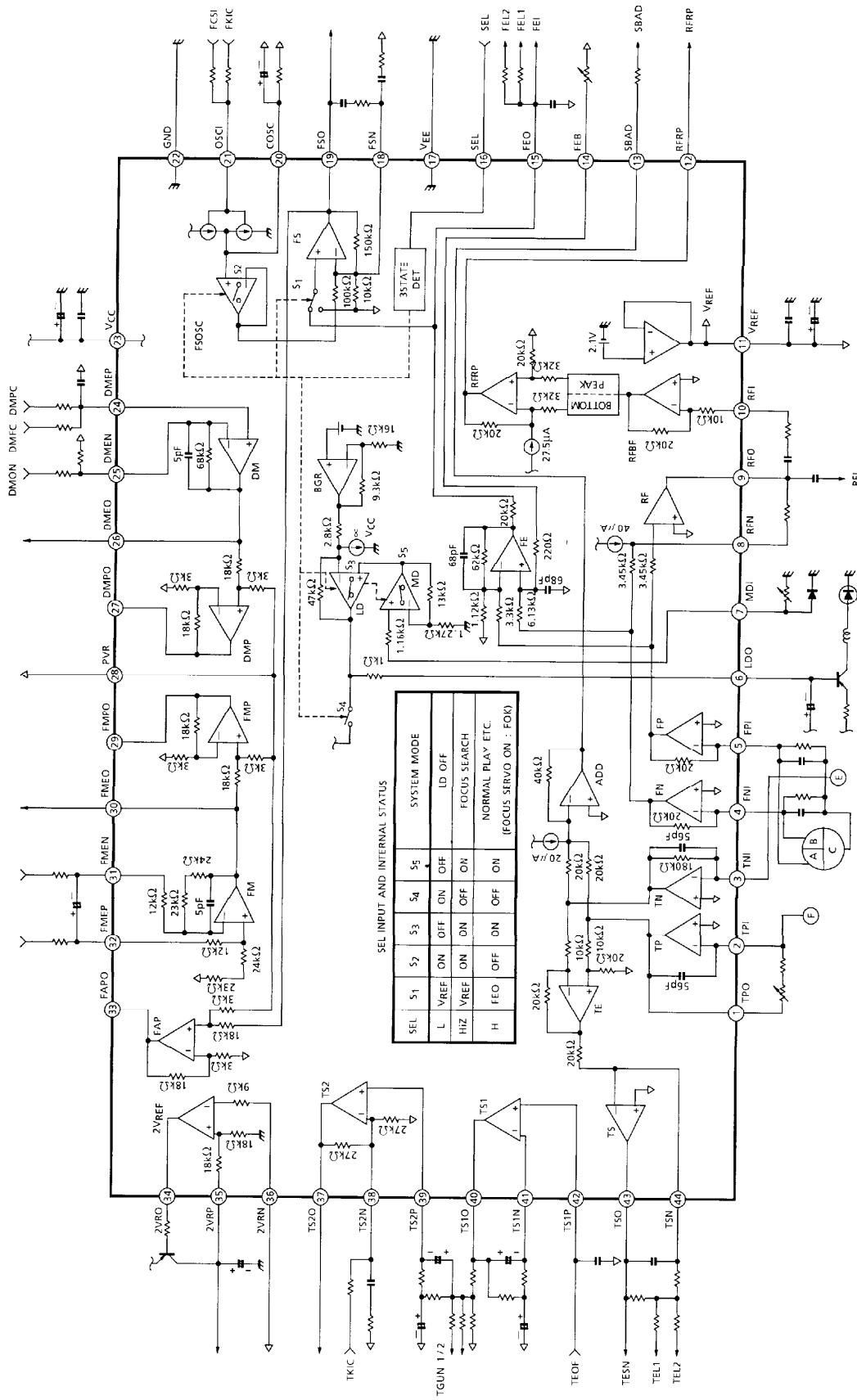

PIN FUNCTION

PIN No.	SYMBOL	I/O	FUNCTION DESCRIPTION	REMARKS
1	TPO	O	Sub-beam I-V amp (TP AMP) output terminal.	Connected to TPI through adjusting feedback resistor.
2	TPI	I	Sub-beam I-V amp (TP AMP) input terminal.	Connected to pin diode F.
3	TNI	I	Sub-beam I-V amp (TN AMP) input terminal.	Connected to pin diode E.
4	FNI	I	Main-beam I-V amp (FN AMP) input terminal.	Connected to pin diode B + C.
5	FPI	I	Main-beam I-V amp (FP AMP) input terminal.	Connected to pin diode A + C.
6	LDO	O	Laser diode amp (LD AMP) input terminal.	Connected to laser diode circuit.
7	MDI	I	Monitor photo diode amp (MD AMP) input terminal.	Connected to monitor photo diode.
8	RFN	I	RF amp (RF AMP) negative phase input terminal.	Connected to RFO through feedback resistor.
9	RFO	O	RF amp (RF AMP) output terminal.	—
10	RFI	I	RF ripple signal generating circuit input terminal.	Connected to RFO through CR.
11	V _{REF}	O	Reference voltage output terminal. (+2.1V)	—
12	RFRP	O	RF ripple signal output terminal.	—
13	SBAD	O	Defects detection signal output terminal.	—
14	FEB	I	Focus error balance adjusting input terminal.	Adjusting semi-fixed resistor is connected.
15	FEO	O	Focus error amp (FE AMP) output terminal.	Gain adjusting resistor is connected.
16	SEL	I	Analog switch control signal input terminal.	—
17	V _{EE}	—	Power source terminal. (GND)	—
18	FSN	I	Focus output amp (FS AMP) negative phase input terminal.	Connected to FSO through feedback CR.
19	FSO	O	Focus output amp (FS AMP) output terminal.	—
20	COSC	O	Focus search signal generating capacitor connecting terminal.	CR is connected.
21	OSCI	I	Focus search signal generating built-in current source control input terminal.	—
22	GND	—	Ground terminal	—
23	V _{CC}	—	Power source terminal. (+5V)	—
24	DMEP	I	Disc motor amp (DM AMP) positive phase input terminal.	—
25	DMEN	I	Disc motor amp (DM AMP) negative phase input terminal.	—
26	DMEO	O	Disc motor amp (DM AMP) output terminal.	—
27	DMPO	O	Disc motor driving amp (DMP AMP) output terminal.	—

PIN No.	SYMBOL	I/O	FUNCTION DESCRIPTION	REMARKS
28	PVR	I	Driving amp reference voltage input terminal.	Connected to V_{REF} .
29	FMPO	O	Feed motor driving amp (FMP AMP) output terminal.	—
30	FMEO	O	Feed motor amp (FM AMP) output terminal.	—
31	FMEN	I	Feed motor amp (FM AMP) negative phase input terminal.	—
32	FMEP	I	Feed motor amp (FM AMP) positive phase input terminal.	—
33	FAPO	O	Focus actuator driving amp (FAP AMP) output terminal.	—
34	2VRO	O	2V _{REF} amp (2V _{REF} AMP) output terminal.	Connected to 2VRP through external output Tr.
35	2VRP	I	2V _{REF} amp (2V _{REF} AMP) positive phase input terminal.	—
36	2VRN	I	2V _{REF} amp (2V _{REF} AMP) negative phase input terminal.	—
37	TS2O	O	Tracking servo amp 2 (TS2 AMP) output terminal.	—
38	TS2N	I	Tracking servo amp 2 (TS2 AMP) negative phase input terminal.	—
39	TS2P	I	Tracking servo amp 2 (TS2 AMP) positive phase input terminal.	—
40	TS1O	O	Tracking servo amp 1 (TS1 AMP) output terminal.	—
41	TS1N	I	Tracking servo amp 1 (TS1 AMP) negative phase input terminal.	Connected to TS1O through feedback CR.
42	TS1P	I	Tracking servo amp 1 (TS1 AMP) positive phase input terminal.	—
43	TSO	O	Tracking output amp (TS AMP) output terminal.	—
44	TSN	I	Tracking output amp (TS AMP) negative phase input terminal.	Connected to TSO through feedback CR.

MAXIMUM RATINGS (Ta = 25°C)

CHARACTERISTIC	SYMBOL	RATING	UNIT
Power Supply Voltage	V _{CC} -V _{EE}	0.3~12.0	V
Power Dissipation	P _D *	780	mW
Operating Temperature	T _{opr}	- 25~75	°C
Storage Temperature	T _{stg}	- 55~150	°C

* Derated above 25°C in the proportion of 6.2mW/°C.

ELECTRICAL CHARACTERISTICS (Unless otherwise specified, V_{CC} = 5V, V_{EE} = GND, Ta = 25°C)

CHARACTERISTIC		SYMBOL	TEST CIRCUIT	TEST CONDITION	MIN.	TYP.	MAX.	UNIT
Power Source	Power Supply Voltage	V _{CC}	—	Ta = - 25~75°C	4.5	5.0	5.5	V
	Power Supply Current	I _{CC}	1	—	14.0	24.0	32.0	mA
Reference Power Supply V _{REF}	Reference Voltage	V _{REF}	1	—	1.95	2.10	2.25	V
	Reference Voltage Temperature Characteristic	ΔV / ΔT	1	—	- 3.0	- 2.0	- 1.0	mV / °C
	Output Current	I _{OH}	1	—	5.0	—	—	mA
	Input Current	I _{OL}	1	—	5.0	—	—	mA
FI ↓ RFO	Permissive Input Current	I _{IM}	1	Per each ch	30	—	—	μA
	Transfer Resistance	R _T	1	f = 100kHz	115	127	140	kΩ
	Frequency Characteristic	f _c	2	- 3dB point	3.0	—	—	MHz
	Output Signal Slew Rate	SR	2	C _{RFO} = 20pF	10	20	—	V / μs
	Total Harmonic Distortion	THD	1	f = 100kHz V _{REO} = 1.27V _{p-p}	—	- 40	- 30	dB
	Operation Reference Voltage	V _{OPR}	1	V _{REF} reference	- 1.13	- 0.88	- 0.72	V
	Upper Limit Output Voltage	V _{OH}	1	V _{REF} reference	1.4	—	—	V
	Lower Limit Output Voltage	V _{OL}	1	V _{REF} reference	—	—	- 1.4	V
	Permissive Load Resistance	R _{LM}	—	—	10	—	—	kΩ
RFI ↓ RFRP	Input Operating Voltage	V _I	1	—	0.8	—	1.6	V _{p-p}
	Voltage Gain	G _V	1	f = 1kHz	0.55	0.62	0.69	V / V
	Peak Hold Frequency Characteristic	f _{CPD}	1	—	60	120	240	kHz
	Bottom Hold Frequency Characteristic	f _{CBD}	1	—	60	120	240	kHz
	Operation Reference Voltage 1	V _{OPR}	1	V _{REF} reference	- 0.61	- 0.55	- 0.49	V
	Operation Reference Voltage 2	V _{OPR}	1	V _{REF} reference, 700kHz, 1V _{p-p} input	- 120	0	120	mV
	Permissive Load Resistance	R _{LM}	—	—	10	—	—	kΩ

CHARACTERISTIC		SYMBOL	TEST CIR-CUIT	TEST CONDITION	MIN.	TYP.	MAX.	UNIT
FI ↓ FEO	Transfer Resistance	R_T	1	$f = 1\text{kHz}$, FPI→FEO	293	376	458	$k\Omega$
	Gain Balance	GB	1	$f = 1\text{kHz}$	-1.5	—	1.5	dB
	Frequency Characteristic	f_c	1	-3dB point	20	30	60	kHz
	Total Harmonic Distortion	THD	1	$f = 1\text{kHz}$ $V_{FEO} = 1.7V_{p-p}$	—	—	-40	dB
	Output Offset Voltage	V_{OS}	1	V_{REF} reference	-300	—	300	mV
	Offset Voltage Drift	$\Delta V / \Delta T$	1	—	-1.2	—	1.2	$mV / ^\circ C$
	Upper Limit Output Voltage	V_{OH}	1	V_{REF} reference	1.5	—	—	V
	Lower Limit Output Voltage	V_{OL}	1	V_{REF} reference	—	—	-1.5	V
TI ↓ TSO	Permissive Input Current	I_{IM}	1	Per each ch	5.0	—	—	μA
	Transfer Resistance	R_T	1	$f = 1\text{kHz}$	354	432	554	$k\Omega$
	Gain Balance	GB	1	$f = 1\text{kHz}$	-2.0	—	2.0	dB
	Frequency Characteristic	f_c	1	-3dB point	10	16	30	kHz
	Total Harmonic Distortion	THD	1	$f = 1\text{kHz}$ $V_{TSO} = 0.8V_{p-p}$	—	—	-40	dB
	Output Offset Voltage	V_{OS}	1	V_{REF} reference	-50	—	50	mV
	Offset Voltage Drift	$\Delta V / \Delta T$	1	—	-200	—	200	$\mu V / ^\circ C$
	Upper Limit Output Voltage	V_{OH}	1	V_{REF} reference	1.5	—	—	V
	Lower Limit Output Voltage	V_{OL}	1	V_{REF} reference	—	—	-1.5	V
	Permissive Load Resistance	R_{LM}	—	—	10	—	—	$k\Omega$
TI ↓ SBAD	Permissive Input Current	I_{IM}	1	Total in both ch	7.0	—	—	μA
	Transfer Resistance	R_T	1	$f = 1\text{kHz}$	280	360	440	$k\Omega$
	Frequency Characteristic	f_c	1	-3dB point	10	16	30	kHz
	Total Harmonic Distortion	THD	1	$f = 1\text{kHz}$ $V_{SBAD} = 1.6V_{p-p}$	—	—	-40	dB
	Operation Reference Voltage	V_{OPR}	1	V_{REF} reference	-0.88	-0.80	-0.72	V
	Upper Limit Output Voltage	V_{OH}	1	V_{REF} reference	1.5	—	—	V
	Lower Limit Output Voltage	V_{OL}	1	V_{REF} reference	—	—	-1.5	V
	Permissive Load Resistance	R_{LM}	—	—	10	—	—	$k\Omega$
OSCI ↓ FSO	Output Amplitude	V_O	—	$f_{OSCI} = 0.5\text{Hz}$ (CMOS level)	610	700	780	mV_{p-p}
	Output Offset Voltage	V_{OS}	—	OSCI : HiZ	-35	—	35	mV
	Output Switch Isolation	V_{ISO}	—	$f_{OSCI} = 0.5\text{Hz}$ SEL : "H" level	—	—	25	mV_{p-p}

CHARACTERISTIC		SYMBOL	TEST CIR-CUIT	TEST CONDITION	MIN.	TYP.	MAX.	UNIT
FEO ↓ FSO	Voltage Gain 1	GV1	—	f = 10kHz V _{FSO} = 1V _{p-p}	14.5	16.0	17.5	V/V
	Voltage Gain 2	GV2	—	R _{NF} (FSO-FSN) : 12kΩ	1.79	2.11	2.43	V/V
	Upper Limit Output Voltage	VOH	—	GND reference	3.6	—	—	V
	Lower Limit Output Voltage	VOL	—	GND reference	—	—	0.5	V
	Output Offset Voltage	VOS	—	—	-32	—	32	mV
	Total Harmonic Distortion	THD	—	f = 10kHz V _{FSO} = 1V _{p-p}	—	—	-40	dB
FEO ↓ FAPO	Voltage Gain	GV	—	f = 10kHz V _{FAPO} = 1V _{p-p}	14.0	16.0	18.0	V/V
	Upper Limit Output Voltage	VOH	—	GND reference	3.6	—	—	V
	Lower Limit Output Voltage	VOL	—	GND reference	—	—	1.0	V
	Output Offset Voltage	VOS	—	—	-40	—	40	mV
	Total Harmonic Distortion	THD	—	f = 10kHz V _{FAPO} = 1V _{p-p}	—	—	-40	dB
TS1P ↓ TS1O	Voltage Gain	GV	—	f = 10kHz V _{TS1O} = 1V _{p-p}	0.95	1.00	1.05	V/V
	Upper Limit Output Voltage	VOH	—	GND reference	3.6	—	—	V
	Lower Limit Output Voltage	VOL	—	GND reference	—	—	1.0	V
	Output Offset Voltage	VOS	—	—	-5.0	—	5.0	mV
	Input Bias Current	I _I	—	—	-100	—	100	nA
	Total Harmonic Distortion	THD	—	f = 10kHz V _{TS1O} = 1V _{p-p}	—	—	-40	dB
TS2P ↓ TS2O	Voltage Gain	GV	—	f = 10kHz V _{TS2O} = 1V _{p-p}	1.9	2.0	2.1	V/V
	Upper Limit Output Voltage	VOH	—	GND reference	3.6	—	—	V
	Lower Limit Output Voltage	VOL	—	GND reference	—	—	0.5	V
	Output Offset Voltage	VOS	—	—	-10	—	10	mV
	Input Bias Current	I _I	—	—	-100	—	100	nA
	Total Harmonic Distortion	THD	—	f = 10kHz V _{TS2O} = 1V _{p-p}	—	—	-40	dB
DMEP ↓ DMEO	Voltage Gain	GV	—	f = 10kHz V _{DMEO} = 1V _{p-p}	5.7	6.7	7.7	V/V
	Upper Limit Output Voltage	VOH	—	GND reference	3.6	—	—	V
	Lower Limit Output Voltage	VOL	—	GND reference	—	—	0.5	V
	Output Offset Voltage	VOS	—	—	-15	—	15	mV
	Total Harmonic Distortion	THD	—	f = 10kHz V _{DMEO} = 1V _{p-p}	—	—	-40	dB

CHARACTERISTIC		SYMBOL	TEST CIR-CUIT	TEST CONDITION	MIN.	TYP.	MAX.	UNIT
DMEP ↓ DMPO	Voltage Gain	G _V	—	f = 10kHz V _{DMPO} = 1V _{p-p}	5.4	6.7	8.0	V/V
	Upper Limit Output Voltage	V _{OH}	—	GND reference	3.6	—	—	V
	Lower Limit Output Voltage	V _{OL}	—	GND reference	—	—	1.2	V
	Output Offset Voltage	V _{OS}	—	—	-30	—	30	mV
	Total Harmonic Distortion	THD	—	f = 10kHz V _{DMPO} = 1V _{p-p}	—	—	-40	dB
FMEP ↓ FMEO	Voltage Gain	G _V	—	f = 10kHz V _{FMEO} = 1V _{p-p} V _{FMEN} = V _{REF}	3.6	3.9	4.3	V/V
	Upper Limit Output Voltage	V _{OH}	—	GND reference	3.6	—	—	V
	Lower Limit Output Voltage	V _{OL}	—	GND reference	—	—	0.5	V
	Output Offset Voltage	V _{OS}	—	—	-15	—	15	mV
	Total Harmonic Distortion	THD	—	f = 10kHz V _{FMEO} = 1V _{p-p}	—	—	-40	dB
FMEP ↓ FMPO	Voltage Gain	G _V	—	f = 10kHz V _{FMPO} = 1V _{p-p} V _{FMEN} = V _{REF}	3.4	3.9	4.6	V/V
	Upper Limit Output Voltage	V _{OH}	—	GND reference	3.6	—	—	V
	Lower Limit Output Voltage	V _{OL}	—	GND reference	—	—	1.0	V
	Output Offset Voltage	V _{OS}	—	—	-20	—	20	mV
	Total Harmonic Distortion	THD	—	f = 10kHz V _{FMPO} = 1V _{p-p}	—	—	-40	dB
2VRN ↓ 2VR	DC Voltage Gain	G _{VDC}	—	V _{2VR} = V _{REF}	1.90	2.00	2.10	V/V
MDI ↓ LDO	Reference Operating Voltage	V _{MDI}	—	V _{MDI} at which V _{LDO} becomes 3.5V.	170	178	192	mV
	Voltage Gain	G _V	—	f = 10kHz V _{LDO} = 0.5V _{p-p}	170	200	230	V/V
	Input Bias Current	I _I	—	—	-200	—	200	nA
	Ripple Removing Ratio (with V _{CC})	RR	—	Input converted value	—	—	-56	dB
	Frequency Characteristic	f _c	—	-3dB point	20	—	—	kHz
	LD Off Voltage (with V _{CC})	V _{LD OFF}	—	SEL = L	-0.7	—	—	V

TEST CIRCUIT 1

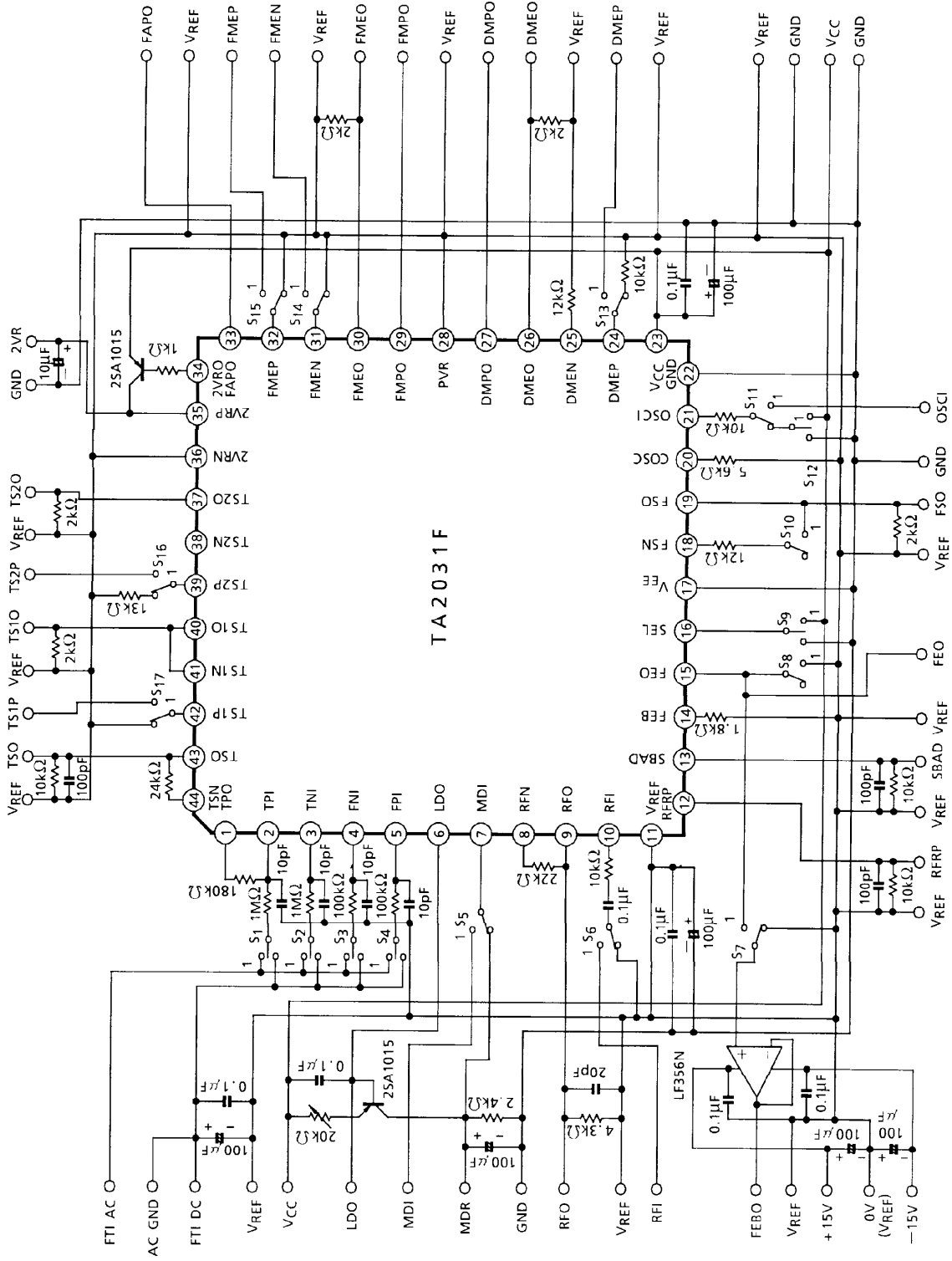

TA2031F-9

TEST CIRCUIT 2

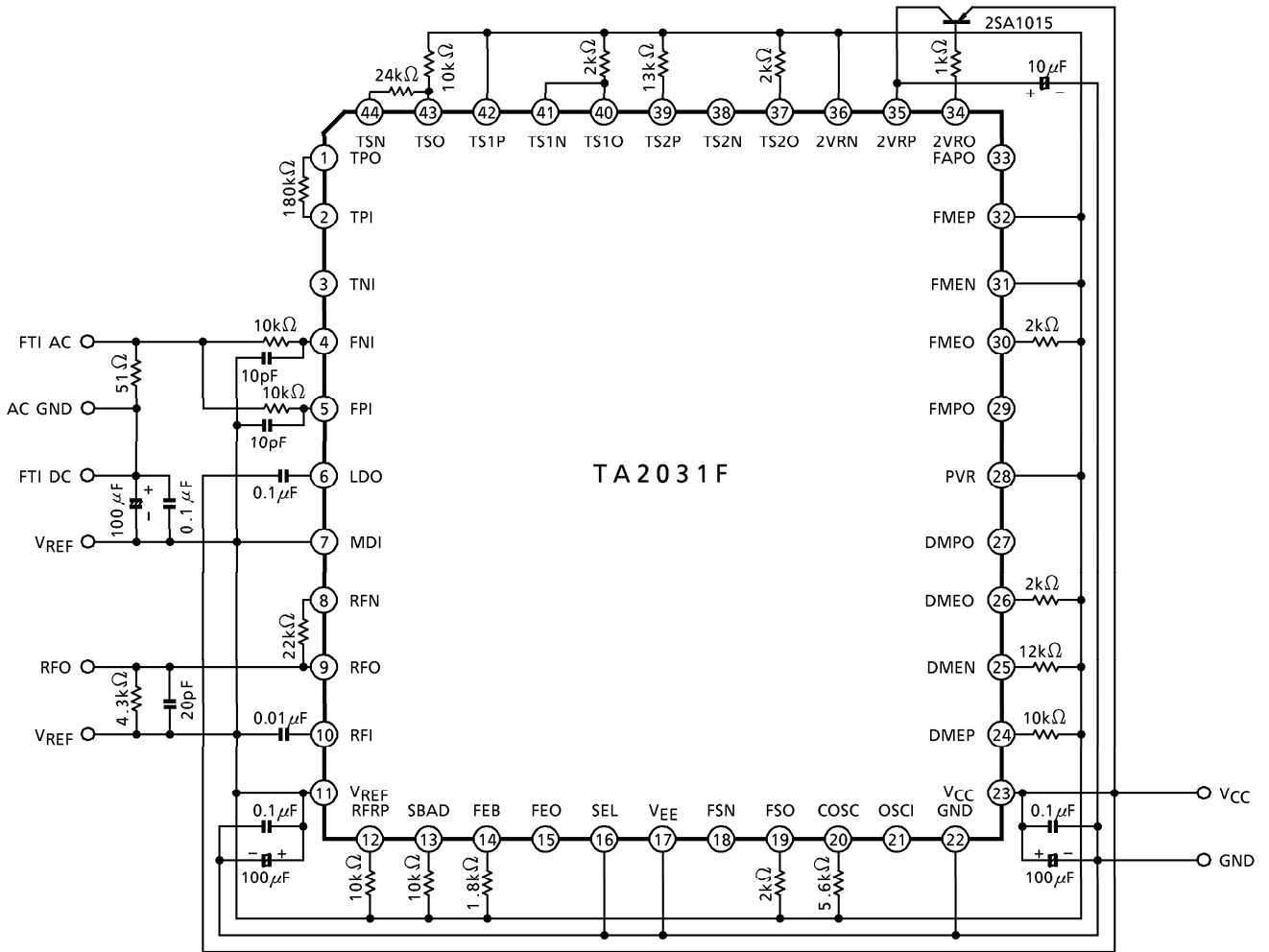

PACKAGE DIMENSIONS
QFP44-P-1010-0.80C

Unit : mm

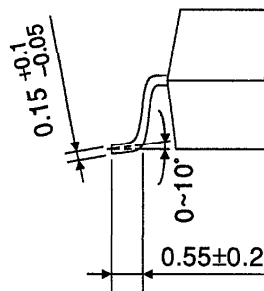
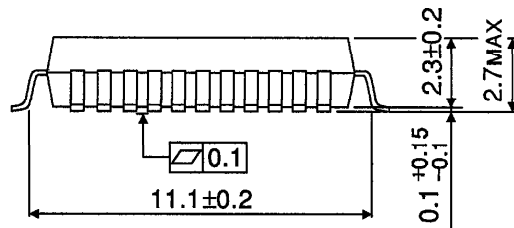
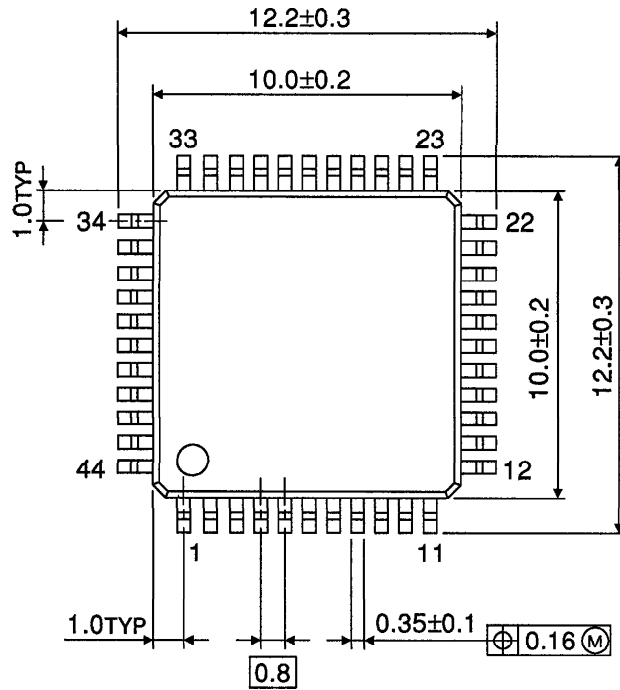

Weight : 0.5g (Typ.)