

### FEATURES

- Single-/Dual-Supply Operation, 1.6 V to 36 V,  $\pm 0.8$  V to  $\pm 18$  V
- True Single-Supply Operation; Input and Output Voltage Ranges Include Ground
- Low Supply Current (Per Amplifier), 20  $\mu$ A Max
- High Output Drive, 5 mA Min
- Low Input Offset Voltage, 200  $\mu$ V Max
- High Open-Loop Gain, 700 V/mV Min
- Outstanding PSRR, 5.6  $\mu$ V/V Max
- Industry Standard 8-Lead Dual Pinout
- Available in Die Form

### GENERAL DESCRIPTION

The OP290 is a high performance micropower dual op amp that operates from a single supply of 1.6 V to 36 V or from dual supplies of  $\pm 0.8$  V to  $\pm 18$  V. Input voltage range includes the negative rail allowing the OP290 to accommodate input signals down to ground in single-supply operation. The OP290's output swing also includes ground when operating from a single supply, enabling "zero-in, zero-out" operation.

The OP290 draws less than 20  $\mu$ A of quiescent supply current per amplifier, while able to deliver over 5 mA of output current to a load. Input offset voltage is below 200  $\mu$ V eliminating the need for external nulling. Gain exceeds 700,000 and common-mode rejection is better than 100 dB. The power supply rejection ratio of under 5.6 pV/V minimizes offset voltage changes experienced in battery-powered systems. The low offset voltage and high gain offered by the OP290 bring precision performance to micropower applications. The minimal voltage and current requirements of the OP290 suit it for battery- and solar-powered applications, such as portable instruments, remote sensors, and satellites. For a single op amp, see the OP90; for a quad, see the OP490.

### PIN CONNECTIONS

#### 16-Lead SOL (S-Suffix)

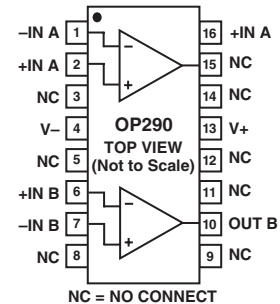

#### EPOXY MINI-DIP (P-Suffix)

#### 8-Lead HERMETIC DIP (Z-Suffix)

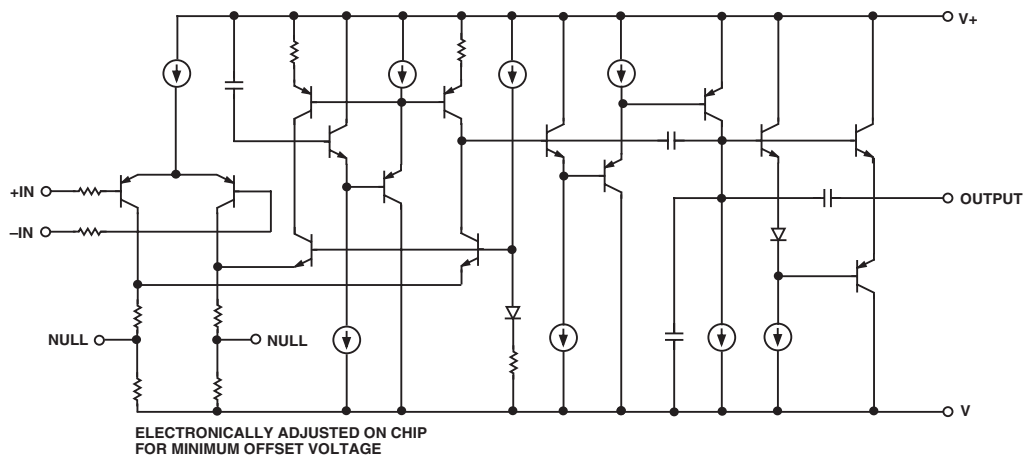
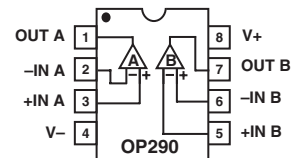

Figure 1. Simplified Schematic (one of two amplifiers is shown)

REV. A

Information furnished by Analog Devices is believed to be accurate and reliable. However, no responsibility is assumed by Analog Devices for its use, nor for any infringements of patents or other rights of third parties that may result from its use. No license is granted by implication or otherwise under any patent or patent rights of Analog Devices.

One Technology Way, P.O. Box 9106, Norwood, MA 02062-9106, U.S.A.  
 Tel: 781/329-4700 www.analog.com  
 Fax: 781/326-8703 © Analog Devices, Inc., 2002

# OP290—SPECIFICATIONS

## ELECTRICAL CHARACTERISTICS (@ $V_S = \pm 1.5\text{ V}$ to $\pm 15\text{ V}$ , $T_A = 25^\circ\text{C}$ , unless otherwise noted.)

Parameter	Symbol	Conditions	OP290E			OP290F			OP290G			Unit
			Min	Typ	Max	Min	Typ	Max	Min	Typ	Max	
INPUT OFFSET VOLTAGE	$V_{OS}$		50	200		75	300	125	500		$\mu\text{V}$	
INPUT OFFSET CURRENT	$I_{OS}$	$V_{CM} = 0\text{ V}$	0.1	3		0.1	5	0.1	5		nA	
INPUT BIAS CURRENT	$I_B$	$V_{CM} = 0\text{ V}$	4.0	15		4.0	20	4.0	25		nA	
LARGE-SIGNAL VOLTAGE GAIN	$A_{VO}$	$V_S = \pm 15\text{ V}$ , $V_O = \pm 10\text{ V}$ $R_L = 100\text{ k}\Omega$ $R_L = 10\text{ k}\Omega$ $R_L = 2\text{ k}\Omega$ $V_+ = 5\text{ V}$ , $V_- = 0\text{ V}$ , $1\text{ V} < V_O < 4\text{ V}$ $R_L = 100\text{ k}\Omega$ $R_L = 10\text{ k}\Omega$	700 350 125	1200 600 250		500 250 100	1000 500 200	400 200 100	600 400 200		V/mV	
INPUT VOLTAGE RANGE <sup>1</sup>	IVR	$V_+ = 5\text{ V}$ , $V_- = 0\text{ V}$ $V_S = \pm 5\text{ V}^1$	0/4 -15/13.5			0/4 -15/13.5		0/4 -15/13.5			V	
OUTPUT VOLTAGE SWING	$V_O$	$V_S = \pm 5\text{ V}$ $R_L = 10\text{ k}\Omega$ $R_L = 2\text{ k}\Omega$	$\pm 13.5 \pm 14.2$ $\pm 10.5 \pm 11.5$			$\pm 13.5 \pm 14.2$ $\pm 10.5 \pm 11.5$		$\pm 13.5$ $\pm 14.2$ V $\pm 10.5$ $\pm 11.5$			V	
	$V_{OH}$	$V_+ = 5\text{ V}$ , $V_- = 0\text{ V}$ $V_+ = 5\text{ V}$ , $V_- = 0\text{ V}$	40	4.2		4.0	4.2	4.0	4.2		V	
	$V_{OL}$	$R_L = 10\text{ k}\Omega$	10	50		10	50	10	50		$\mu\text{V}$	
COMMON-MODE REJECTION	CMR	$V_+ = 5\text{ V}$ , $V_- = 0\text{ V}$ $0\text{ V} < V_{CM} < 4\text{ V}$ $V_S = \pm 15\text{ V}$ , $-15\text{ V} < V_{CM} < 13.5\text{ V}$	100	120	ttS	90	120	80	100	80	100	dB
POWER SUPPLY REJECTION RATIO	PSRR		10	5.6		10	5.6	3.2	10		$\mu\text{V/V}$	
SUPPLY CURRENT (All Amplifiers)	$I_{SY}$	$V_S = \pm 1.5\text{ V}$ $V_S = \pm 15\text{ V}$	19 25	30 40		19 25	30 40	19 25	30 40		$\mu\text{A}$	
CAPACITIVE LOAD STABILITY		$A_V = +1$ No Oscillations	650			650		650			PF	
INPUT NOISE VOLTAGE <sup>1</sup>	$e_{np-p}$	$f_0 = 0.1\text{ Hz}$ to $10\text{ Hz}$ $V_S = \pm 15\text{ V}$	3			3		3			$\mu\text{V}_{p-p}$	
INPUT RESISTANCE DIFFERENTIAL-MODE	$R_{IN}$	$V_S = \pm 15\text{ V}$	30			30		30			M $\Omega$	
INPUT RESISTANCE COMMON-MODE	$R_{INCM}$	$V_S = \pm 15\text{ V}$	20			20		20			G $\Omega$	
SLEW RATE	SR	$A_V = +1$ $V_S = \pm 15\text{ V}$	5	12		5	12	5	12		V/ms	
GAIN BANDWIDTH PRODUCT	GBWP	$V_S = +15\text{ V}$ $V_S = \pm 15\text{ V}$	20			20		20			kHz	
CHANNEL SEPARATION <sup>2</sup>	CS	$f_0 = 10\text{ Hz}$ $V_O = 20\text{ V}_{p-p}$ $V_S = \pm 15\text{ V}^2$	120	150		120	150	120	150		dB	

### NOTES

<sup>1</sup>Guaranteed by CMR test.

<sup>2</sup>Guaranteed but not 100% tested.

Specifications subject to change without notice.

**ELECTRICAL CHARACTERISTICS** (@  $V_S = \pm 1.5\text{ V}$  to  $\pm 15\text{ V}$ ,  $-55^\circ\text{C} \leq T_A \leq 125^\circ\text{C}$ , unless otherwise noted.)

Parameter	Symbol	Conditions	OP290A			Unit
			Min	Typ	Max	
INPUT OFFSET VOLTAGE	$V_{OS}$			80	500	$\mu\text{V}$
AVERAGE INPUT OFFSET VOLTAGE DRIFT	$TCV_{OS}$	$V_S = 15\text{ V}$		0.3	3	$\mu\text{V}/^\circ\text{C}$
INPUT OFFSET CURRENT	$I_{OS}$	$V_{CM} = 0\text{ V}$		0.1	5	nA
INPUT BIAS CURRENT	$I_B$	$V_{CM} = 0\text{ V}$		4.2	20	nA
LARGE-SIGNAL VOLTAGE GAIN	$A_{VO}$	$V_S = 15\text{ V}$ , $V_O = \pm 10\text{ V}$ $R_L = 100\text{ k}\Omega$ $R_L = 10\text{ k}\Omega$ $R_L = 2\text{ k}\Omega$ $V_+ = 5\text{ V}$ , $V_- = 0\text{ V}$ , $1\text{ V} < V_O < 4\text{ V}$ $R_L = 100\text{ k}\Omega$ $R_L = 10\text{ k}\Omega$	225 125 50	400 240 110		V/mV
INPUT VOLTAGE RANGE*	IVR	$V_+ = 5\text{ V}$ , $V_- = 0\text{ V}$ $V_S = \pm 15\text{ V}^*$	0/3.5 -15/13.5			V
OUTPUT VOLTAGE SWING	$V_O$ $V_{OH}$ $V_{OL}$	$V_S = \pm 15\text{ V}$ $R_L = 10\text{ k}\Omega$ $R_L = 2\text{ k}\Omega$ $V_+ = 5\text{ V}$ , $V_- = 0\text{ V}$ $R_L = 2\text{ k}\Omega$ $V_+ = 5\text{ V}$ , $V_- = 0\text{ V}$ $R_L = 10\text{ k}\Omega$	$\pm 13$ $\pm 10$	$\pm 14.1$ $\pm 11$		V V $\mu\text{V}$
COMMON-MODE REJECTION	CMR	$V_+ = 5\text{ V}$ , $V_- = 0\text{ V}$ , $0\text{ V} < V_{CM} < 13.5\text{ V}$ $V_S = \pm 15\text{ V}$ , $-15\text{ V} < V_{CM} < 13.5\text{ V}$	80 90	105 115		dB
POWER SUPPLY REJECTION RATIO	PSRR			3.2	10	$\mu\text{V}/\text{V}$
SUPPLY CURRENT (All Amplifiers)	$I_{sY}$	$V_S = \pm 1.5\text{ V}$ $V_S = \pm 15\text{ V}$		30 38	50 60	$\mu\text{A}$

## NOTES

\*Guaranteed by CMR test.

Specifications subject to change without notice.

# OP290

## ELECTRICAL CHARACTERISTICS (@ $V_S = \pm 1.5\text{ V}$ to $\pm 15\text{ V}$ , $-40 \pm \text{°C} \leq T_A \leq 85 \text{°C}$ for OP290E/OP290F/OP290G, unless otherwise noted.)

Parameter	Symbol	Conditions	OP290E			OP290F			OP290G			Unit
			Min	Typ	Max	Min	Typ	Max	Min	Typ	Max	
INPUT OFFSET VOLTAGE	$V_{OS}$											
					70	400		115	600		200	750
AVERAGE INPUT OFFSET VOLTAGE DRIFT	$TCV_{OS}$	$V_S = \pm 15\text{ V}$										
					0.3	3		0.6	5		1.2	
INPUT OFFSET CURRENT	$I_{OS}$	$V_{CM} = 0\text{ V}$										
					01	3		0.1	5		0.1	7
INPUT BIAS CURRENT	$I_B$	$V_{CM} = 0\text{ V}$										
					4.2	t5		4.2	20		4.2	25
LARGE-SIGNAL VOLTAGE GAIN	$A_{VO}$	$V_S = \pm 5\text{ V}$ , $V_O = \pm 0\text{ V}$ $R_L = 100\text{ k}\Omega$ $R_L = 10\text{ k}\Omega$ $R_L = 2\text{ k}\Omega$ $V_+ = 5\text{ V}$ , $V_- = 0\text{ V}$ , $1\text{ V} < V_O < 4\text{ V}$ $R_L = 100\text{ k}\Omega$ $R_L = 10\text{ k}\Omega$										V/mV
				500	800		350	700		300	600	
				250	400		175	350		150	250	
				100	200		75	150		75	125	
				150	280		100	220		80	160	
				75	140		50	110		40	90	
INPUT VOLTAGE RANGE*	$IVR$	$V_+ = 5\text{ V}$ , $V_- = 0\text{ V}$ $V_S = +15\text{ V}^*$										V
				0/3.5			0/3.5			0/3.5		
OUTPUT VOLTAGE SWING	$V_O$	$V_S = \pm 15\text{ V}$ $R_L = 10\text{ k}\Omega$ $R_L = 2\text{ k}\Omega$ $V_+ = 5\text{ V}$ , $V_- = 0\text{ V}$ $R_L = 2\text{ k}\Omega$ $V_+ = 5\text{ V}$ , $V_- = 0\text{ V}$ $R_L = 10\text{ k}\Omega$										V
				$\pm 13$	$\pm 14$		$\pm 13$	$\pm 14$		$\pm 13$	$\pm 14$	
				$\pm 10$	$\pm 11$		$\pm 10$	$\pm 11$		$\pm 10$	$\pm 11$	
				3.9	4.1		3.9	4.1		3.9	4.1	
	$V_{OH}$										V	
	$V_{OL}$										V	
											$\mu\text{V}$	
			10	100		10	100		10	100	$\mu\text{V}$	
COMMON-MODE REJECTION	CMR	$V_+ = 5\text{ V}$ , $V_- = 0\text{ V}$ , $0\text{ V} < V_{CM} < 3.5\text{ V}$ $V_S = \pm 15\text{ V}$ $-15\text{ V} < V_{CM} < 13.5\text{ V}$										dB
				85	105		80	100		80	100	
			95	115		90	110		90	110		
POWER SUPPLY REJECTION RATIO	PSRR											$\mu\text{V}/\text{V}$
SUPPLY CURRENT (All Amplifiers)	$I_{SY}$	$V_S = \pm 1.5\text{ V}$ $V_S = \pm 15\text{ V}$										$\mu\text{A}$
					24	50		24	50		24	
			31	60		31	60		31	60		

NOTE

\*Guaranteed by CMR test.

Specifications subject to change without notice.

## ABSOLUTE MAXIMUM RATINGS<sup>1</sup>

Supply Voltage	±18 V
Differential Input Voltage	[(V-) - 20 V] to [(V+) + 20 V]
Common-Mode Input Voltage	[(V-) - 20 V] to [(V+) + 20 V]
Output Short-Circuit Duration	Indefinite
Storage Temperature Range	
P, S, Z Packages	-65°C to +150°C
Operating Temperature Range	
OP290A	-55°C to +125°C
OP290E, OP290F, OP290G	-40°C to +85°C
Junction Temperature (T <sub>j</sub> )	-65°C to +150°C
Lead Temperature Range (Soldering, 60 sec)	300°C

Package Type	$\theta_{jA}^2$	$\theta_{jC}$	Unit
8-Lead Hermetic DIP (Z)	134	12	°C/W
8-Lead Plastic DIP (P)	96	37	°C/W
16-Lead SOL (S)	92	27	°C/W

### NOTES

<sup>1</sup>Absolute Maximum Ratings apply to both DICE and packaged parts, unless otherwise noted.

<sup>2</sup> $\theta_{jA}$  is specified for worst-case mounting conditions, i.e.,  $\theta_{jA}$  is specified for device in socket for CERDIP and P-DIP packages;  $\theta_{jA}$  is specified for device soldered to printed circuit board for SOL package.

### CAUTION

ESD (electrostatic discharge) sensitive device. Electrostatic charges as high as 4000 V readily accumulate on the human body and test equipment and can discharge without detection. Although the OP290 features proprietary ESD protection circuitry, permanent damage may occur on devices subjected to high-energy electrostatic discharges. Therefore, proper ESD precautions are recommended to avoid performance degradation or loss of functionality.

## ORDERING GUIDE

T <sub>A</sub> = 25°C V <sub>os</sub> Max (mV)	Package		Operating Temperature Range
	Cerdip 8-Lead	Plastic	
200	OP290AZ*		MIL
200	OP290EZ*		XIND
300	OP290FZ*		XIND
500		OP290GP	XIND
500		OP290GS*	XIND

\*Not for new designs. Obsolete April 2002.

For military processed devices, please refer to the Standard Microcircuit Drawing (SMD) available at [www.dscc.dla.mil/programs.milspec./default.asp](http://www.dscc.dla.mil/programs.milspec./default.asp)

SMD Part Number	ADI Part Number
5962-89783012A*	OP290ARCMDA
5962-8978301PA*	OP290AZMDA

\*Not for new designs. Obsolete April 2002.



# OP290

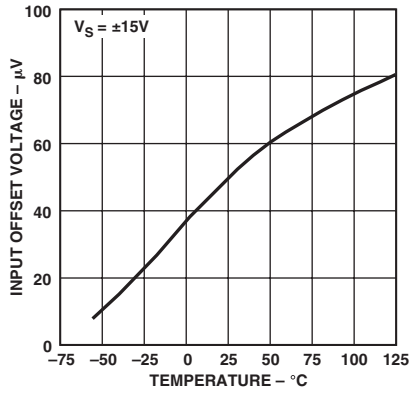

TPC 1. Input Offset Voltage vs. Temperature

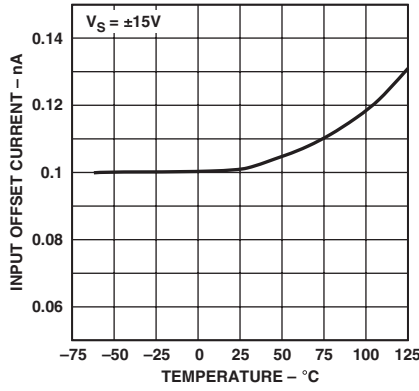

TPC 2. Input Offset Current vs. Temperature

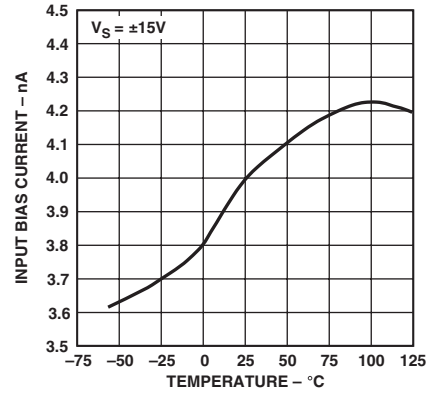

TPC 3. Input Bias Current vs. Temperature

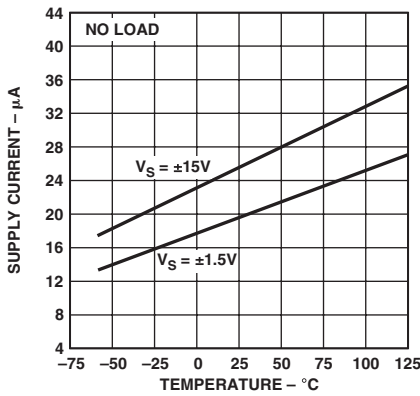

TPC 4. Supply Current vs. Temperature

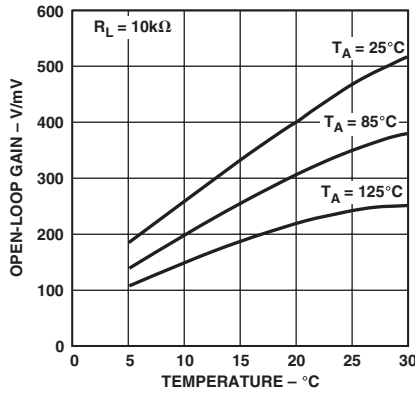

TPC 5. Open-Loop Gain vs. Single-Supply Voltage

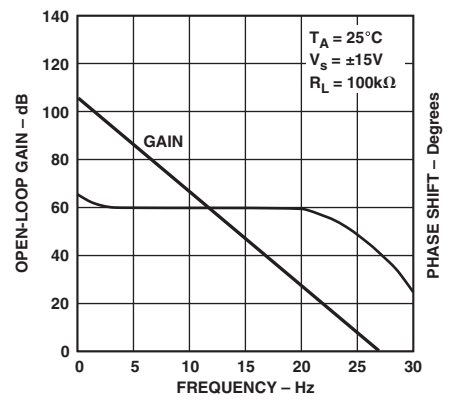

TPC 6. Open-Loop Gain and Phase Shift vs. Frequency

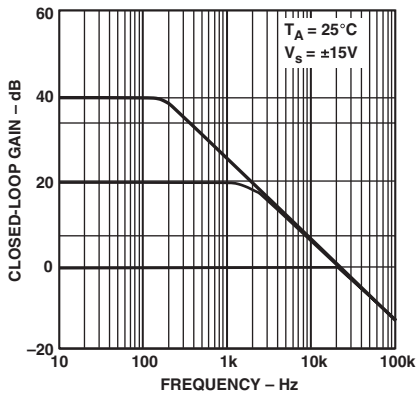

TPC 7. Closed-Loop Gain vs. Frequency

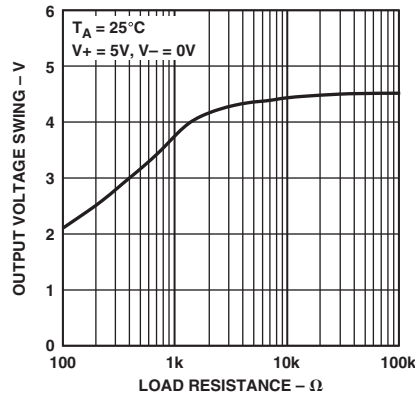

TPC 8. Output Voltage Swing vs. Load Resistance

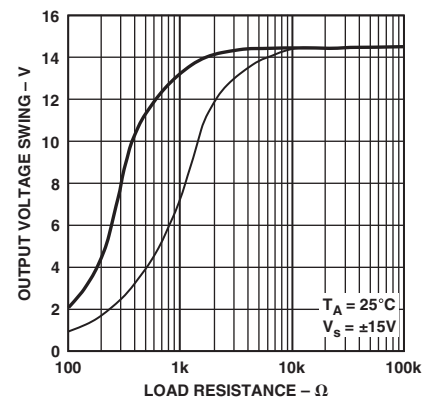

TPC 9. Output Voltage Swing vs. Load Resistance

# Typical Performance Characteristics—OP290

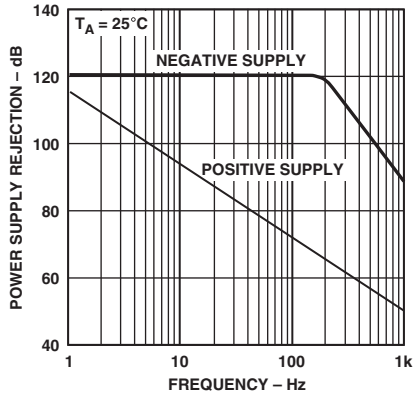

TPC 10. Power Supply Rejection vs. Frequency

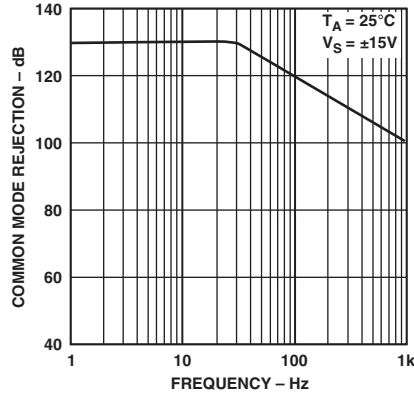

TPC 11. Common-Mode Rejection vs. Frequency

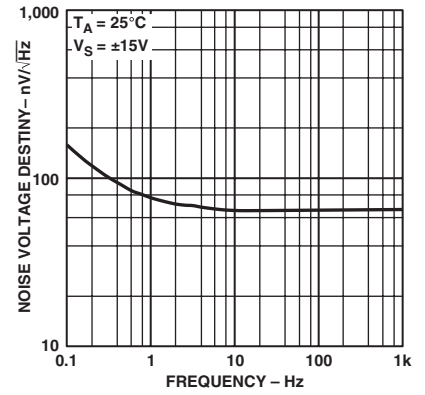

TPC 12. Noise Voltage Density vs. Frequency

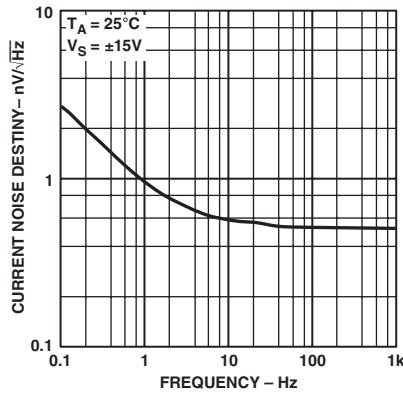

TPC 13. Current Noise Density vs. Frequency

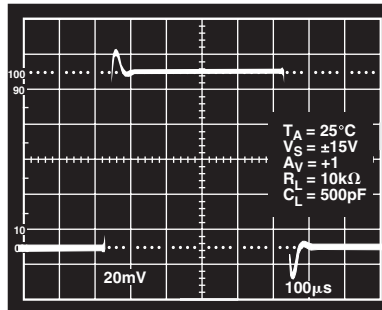

TPC 14. Small-Signal Transient Response

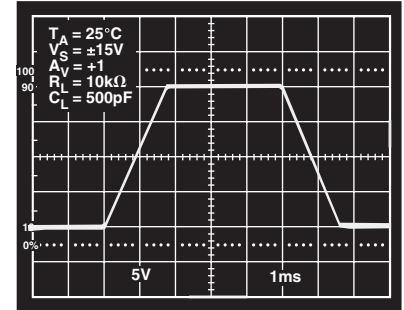

TPC 15. Large-Signal Transient Response





From the formulas, it can be seen that if the span trim is adjusted before the zero trim, the two trims are not interactive, which greatly simplifies the calibration procedure.

Calibration of the transmitter is simple. First, the slope of the output current versus temperature is calibrated by adjusting the span trim, R7. A couple of iterations may be required to be sure the slope is correct.

Once the span trim has been completed, the zero trim can be made. Remember that adjusting the offset trim will not affect the gain.

The offset trim can be set at any known temperature by adjusting R5 until the output current equals:

$$I_{OUT} = \left( \frac{\Delta I_{FS}}{\Delta T_{OPERATING}} \right) (T_{AMBIENT} - T_{MIN}) + 4 mA$$

Table I shows the values of R6 required for various temperature ranges.

Table I.

Temperature Range	R6 (kΩ)
0°C to +70°C	10
-40°C to +85°C	6.2
-55°C to +150°C	3

**VARIABLE SLEW RATE FILTER**

The circuit shown in Figure 6 can be used to remove pulse noise from an input signal without limiting the response rate to a genuine signal. The nonlinear filter has use in applications where the input signal of interest is known to have physical limitations. An example of this is a transducer output where a change of temperature or pressure cannot exceed a certain rate due to physical limitations of the environment. The filter consists of a comparator which drives an integrator. The comparator compares the input voltage to the output voltage and forces the integrator output to equal the input voltage. A1 acts as a comparator with its output high or low. Diodes D1 and D2 clamp the voltage across R3 forcing a constant current to flow in or out of C2. R3, C2, and A2 form an integrator with A2's output slewing at a maximum rate of:

$$\text{Maximum slew rate} = \frac{V_D}{R3 C2} \approx \frac{0.6 V}{R3 C2}$$

For an input voltage slewing at a rate under this maximum slew rate, the output simply follows the input with A1 operating in its linear region.

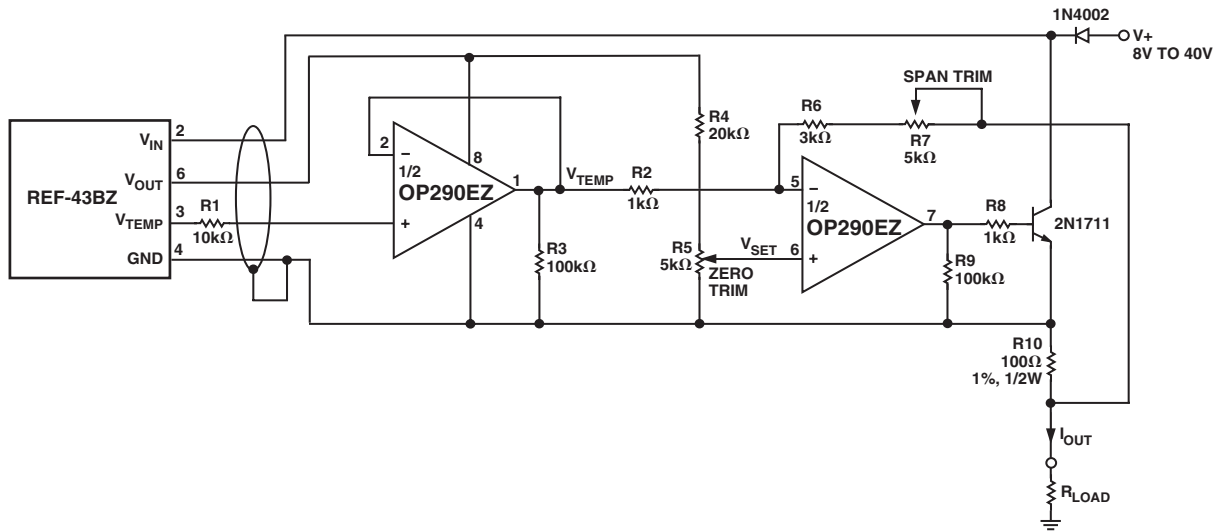

Figure 5. Temperature to 4-20 mA Transmitter

# OP290

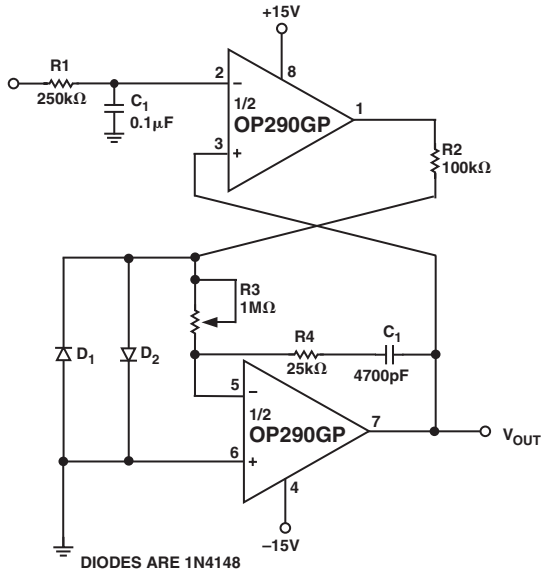

Figure 6. Variable Slew Rate Filter

## LOW OVERHEAD VOLTAGE REFERENCE

Figure 7 shows a voltage reference that requires only 0.1 V of overhead voltage. As shown, the reference provides a stable 4.5 V output with a 4.6 V to 36 V supply. Output voltage drift is only 12 ppm/°C. Line regulation of the reference is under 5 HV/V with load regulation better than 10 μV/mA with up to 50 mA of output current.

The REF-43 provides a stable 2.5 V which is multiplied by the OP290. The PNP output transistor enables the output voltage to approach the supply voltage.

Resistors R1 and R2 determine the output voltage.

$$V_{OUT} = 2.5V \left( 1 + \frac{R2}{R1} \right)$$

The 200 Ω variable resistor is used to trim the output voltage. For the lowest temperature drift, parallel resistors can be used in place of the variable resistor and taken out of the circuit as required to adjust the output voltage.

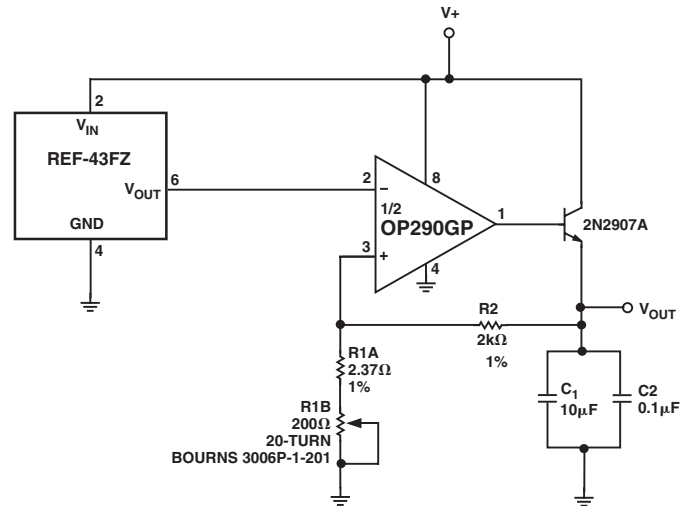

Figure 7. Low Overhead Voltage Reference

# Revision History

Location	Page
<b>Data Sheet changed from REV. 0 to REV. A.</b>	
Edits to ORDERING INFORMATION .....	1
Edits to PIN CONNECTIONS .....	1
Edits to ABSOLUTE MAXIMUM RATINGS .....	2
Edits to PACKAGE TYPE .....	2
Edits to WAFER TEST LIMITS .....	5
Edits to DICE CHARACTERISTICS .....	5

