

CNZ3731, CNC7C501, CNZ3734 CNC2S501, CNC7C502, CNC7H501

Optoisolators

Overview

The CNZ3731 series of optoisolators consist of a GaAs infrared LED which is optically coupled with a Si NPN Darlington phototransistor, and housed in a small DIL package. The series provides high I/O isolation voltage and high collector/emitter isolation voltage, as well as a high current transfer ratio (CTR). This optoisolator series also includes the two-channel CNC7C501 and the four-channel CNZ3734, and A type of these models with increased collector to emitter breakdown voltage ($V_{CEO} > 350V$).

Features

- High collector to emitter breakdown voltage : $V_{CEO} > 300 V$
A type : $V_{CEO} > 350 V$
- High current transfer ratio with Darlington phototransistor output : $CTR = 4000\%$ (typ.)
- High I/O isolation voltage : $V_{ISO} \geq 5000 V_{rms}$
- Small DIL package for saving mounting space
- UL listed (UL File No. E79920)
- A-type models have a guaranteed internal insulating distance of 0.4 mm

Applications

- Telephones
- Telephone exchange
- FAX
- Programmable controllers
- Signal transfer between circuits with different potentials and impedances

Pin Connection

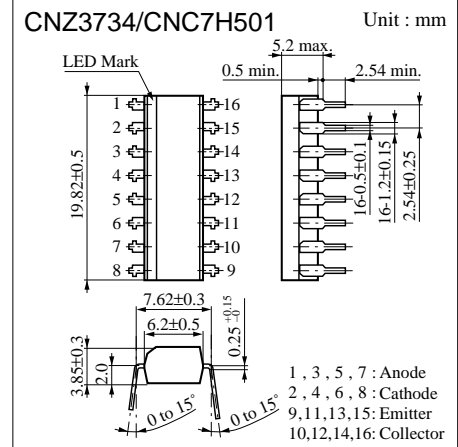
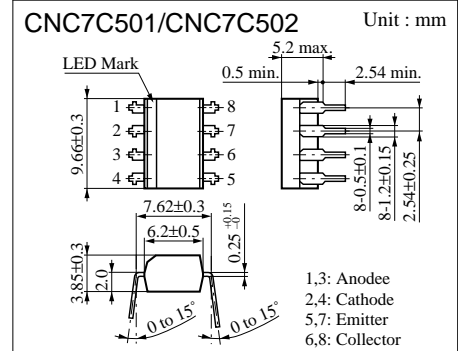
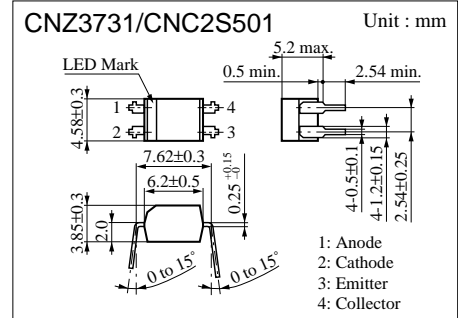
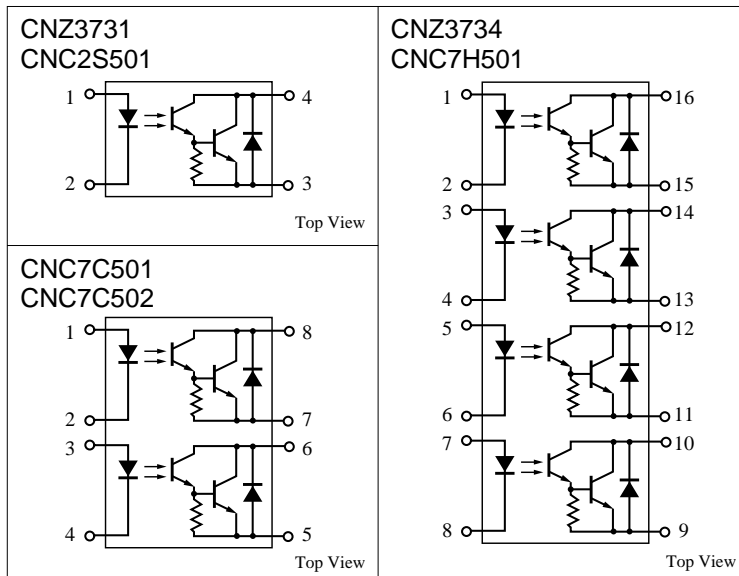

■ Absolute Maximum Ratings (Ta = 25°C)

Parameter		Symbol	Ratings				Unit
			CNZ3731	CNC7C501 CNZ3734	CNC2S501	CNC7C502 CNC7H501	
Input (Light emitting diode)	Reverse voltage (DC)	V _R	6		6		V
	Forward current (DC)	I _F	50		50		mA
	Pulse forward current	I _{FP} ^{*1}	1		1		A
	Power dissipation	P _D ^{*2}	75		75		mW
Output (Photo transistor)	Collector current	I _C	150		150		mA
	Collector to emitter voltage	V _{CEO}	300		350		V
	Emitter to collector voltage	V _{ECO}	0.3		0.3		V
	Collector power dissipation	P _C ^{*3}	300	150	300	150	mW
Total power dissipation		P _T	320	200	320	200	mW
Isolation voltage, input to output		V _{ISO} ^{*4}	5000		5000		V _{rms}
Operating ambient temperature		T _{opr}	-30 to +100		-30 to +100		°C
Storage temperature		T _{stg}	-55 to +125		-55 to +125		°C

*1 Pulse width ≤ 100 μs, repeat 100 pps

*2 Input power derating ratio is 0.75 mW/°C at Ta ≥ 25°C.

*3 Output power derating ratio is 3.0 mW/°C at Ta ≥ 25°C (CNZ3731, CNC2S501).

Output power derating ratio is 0.75 mW/°C at Ta ≥ 25°C (CNC7C501, CNC2S502, CNZ3734, CNC7H501).

*4 AC 1min., RH < 60 %

■ Electrical Characteristics (Ta = 25°C)

Parameter		Symbol	Conditions	min	typ	max	Unit
Input characteristics	Reverse current (DC)	I _R	V _R = 3V			10	μA
	Forward voltage (DC)	V _F	I _F = 50mA		1.35	1.5	V
	Capacitance between pins	C _t	V _R = 0V, f = 1MHz		30		pF
Output characteristics	Collector cutoff current	I _{CEO}	V _{CE} = 200V			200	nA
	Collector to emitter capacitance	C _C	V _{CE} = 10V, f = 1MHz		10		pF
Transfer characteristics	DC current transfer ratio	CTR ^{*1}	V _{CE} = 2V, I _F = 1mA	1000	4000		%
	Isolation capacitance, input to output	C _{ISO}	f = 1MHz		0.7		pF
	Isolation resistance, input to output	R _{ISO}	V _{ISO} = 500V	10 ¹¹			Ω
	Rise time	t _r ^{*2}	V _{CC} = 10V, I _C = 10mA,		40		μs
	Fall time	t _f ^{*3}	R _t = 100Ω		15		μs
Collector to emitter saturation voltage		V _{CE(sat)}	I _F = 1mA, I _C = 2mA			1.0	V

*1 DC current transfer ratio (CTR) is a ratio of output current against DC input current.

$$CTR = \frac{I_C}{I_F} \times 100 (\%)$$

*2 t_r: Time required for the collector current to increase from 10% to 90% of its final value

*3 t_f: Time required for the collector current to decrease from 90% to 10% of its initial value

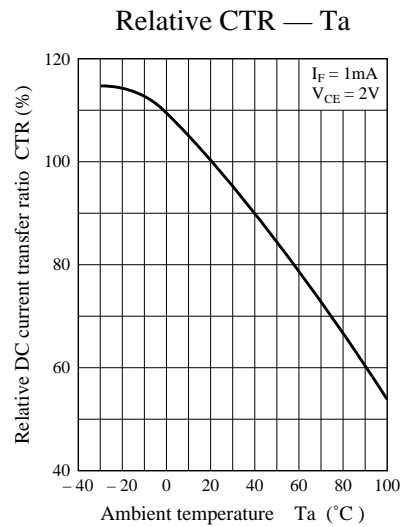
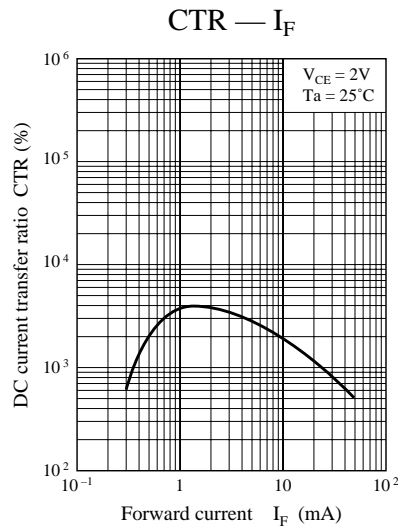
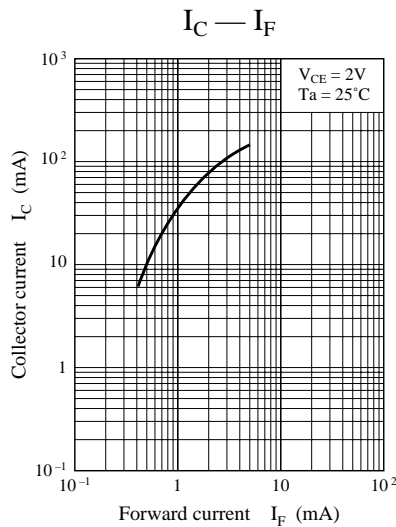
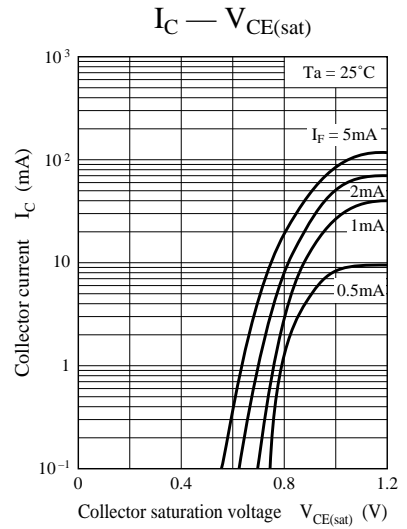
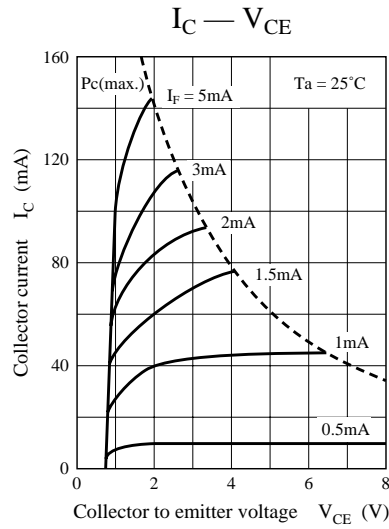
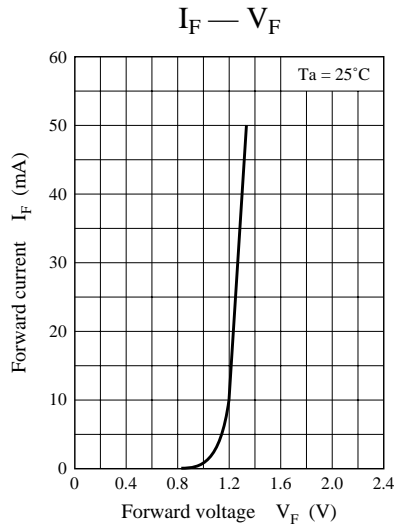
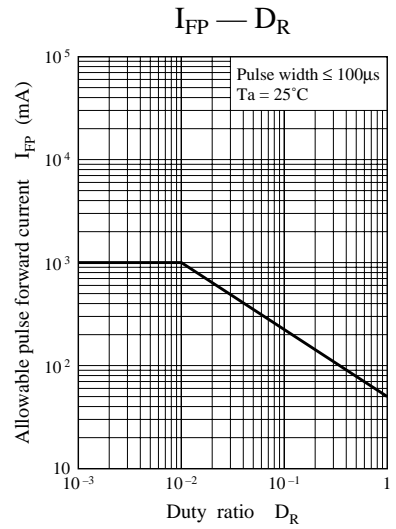
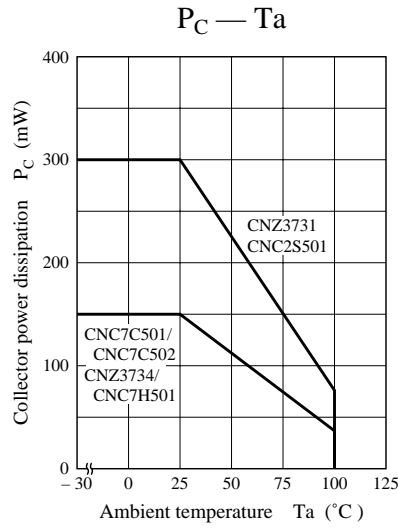
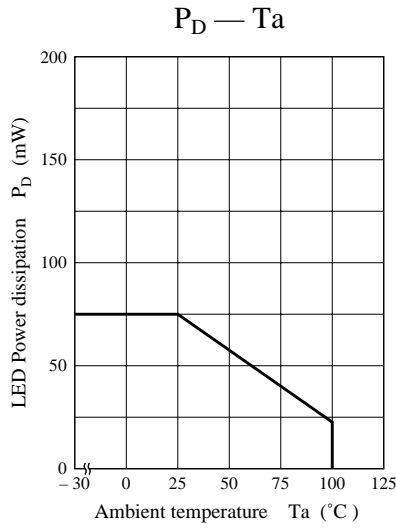

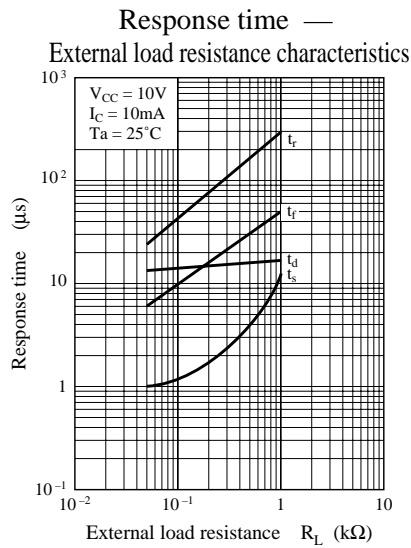
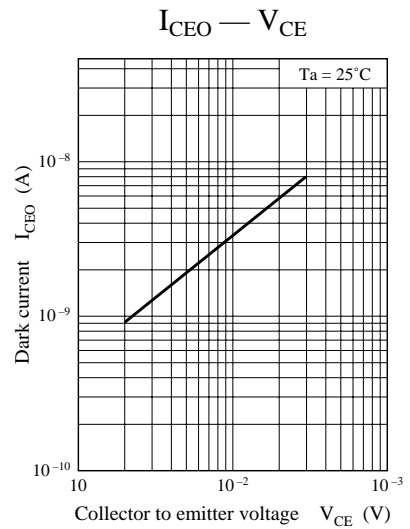
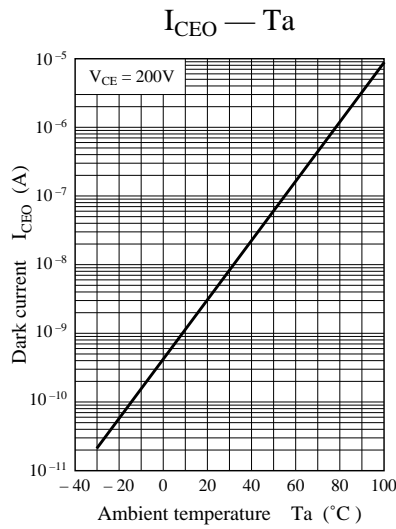
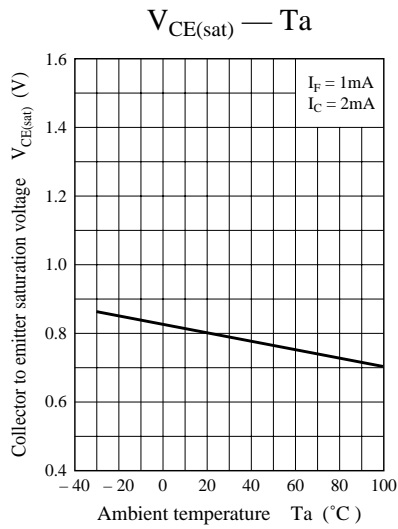

Response time measurement circuit

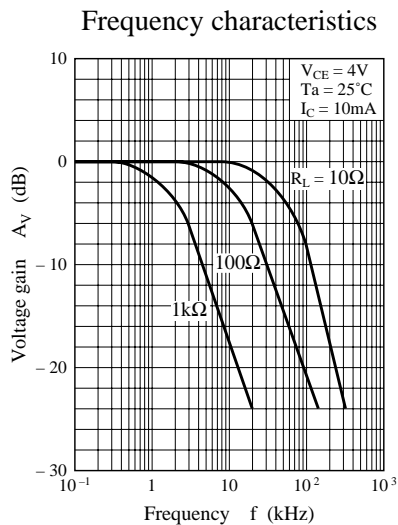
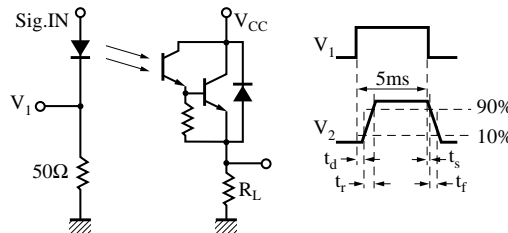

Measurement circuit of frequency characteristics

