

MC13055

Wideband FSK Receiver

The MC13055 is intended for RF data link systems using carrier frequencies up to 40 MHz and FSK (frequency shift keying) data rates up to 2.0 M Baud (1.0 MHz). This design is similar to the MC3356, except that it does not include the oscillator/mixer. The IF bandwidth has been increased and the detector output has been revised to a balanced configuration. The received signal strength metering circuit has been retained, as has the versatile data slicer/comparator.

- Input Sensitivity 20 μV @ 40 MHz
- Signal Strength Indicator Linear Over 3 Decades
- Available in Surface Mount Package
- Easy Application, Few Peripheral Components

WIDEBAND FSK RECEIVER

SEMICONDUCTOR TECHNICAL DATA

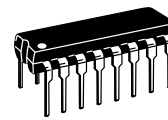

P SUFFIX
PLASTIC PACKAGE
CASE 648

D SUFFIX
PLASTIC PACKAGE
CASE 751B
(SO-16)

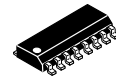

PIN CONNECTIONS

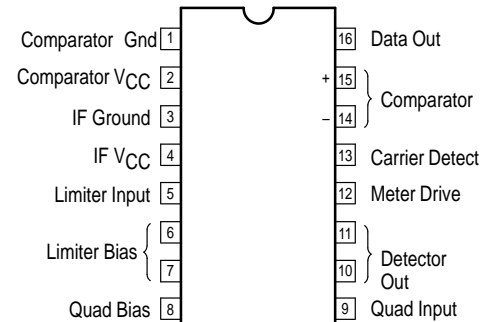
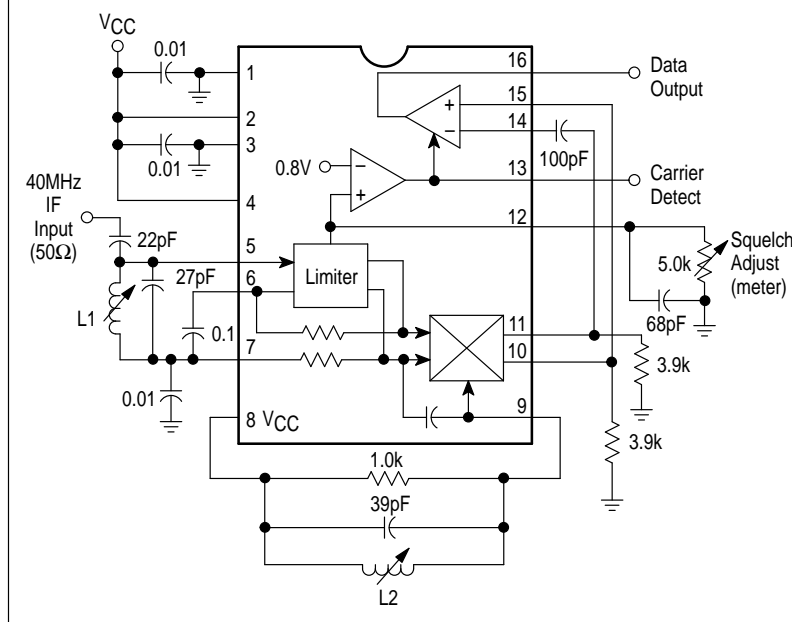

Figure 1. Block Diagram and Application Circuit



ORDERING INFORMATION

Device	Operating Temperature Range	Package
MC13055D	$T_A = -40$ to $+85^\circ\text{C}$	SO-16
MC13055P		Plastic DIP

MC13055

MAXIMUM RATINGS

Rating	Symbol	Value	Unit
Power Supply Voltage	$V_{CC(max)}$	15	Vdc
Operating Supply Voltage Range	V2, V4	3.0 to 12	Vdc
Junction Temperature	T_J	150	°C
Operating Ambient Temperature Range	T_A	-40 to +85	°C
Storage Temperature Range	T_{stg}	-65 to +150	°C
Power Dissipation, Package Rating	P_D	1.25	W

ELECTRICAL CHARACTERISTICS ($V_{CC} = 5.0$ Vdc, $f_0 = 40$ MHz, $f_{mod} = 1.0$ MHz, $\Delta f = \pm 1.0$ MHz, $T_A = 25^\circ\text{C}$, test circuit of Figure 2.)

Characteristic	Conditions	Min	Typ	Max	Unit	
Total Drain Current	I2 + I4	-	20	25	mA	
Data Comparator Pull-Down Current	I16	-	10	-	mA	
Meter Drive Slope versus Input	I12	4.5	7.0	9.0	$\mu\text{A/dB}$	
Carrier Detect Pull-Down Current	I13	-	1.3	-	mA	
Carrier Detect Pull-Up Current	I13	-	500	-	μA	
Carrier Detect Threshold Voltage	V12	690	800	1010	mV	
DC Output Current	I10, I11	-	430	-	μA	
Recovered Signal	V10 - V11	-	350	-	mVrms	
Sensitivity for 20 dB S + N/N, BW = 5.0 MHz	VIN	-	20	-	μVrms	
S + N/N at $V_{in} = 50 \mu\text{V}$	V10 - V11	-	30	-	dB	
Input Impedance @ 40 MHz	R_{in}	Pin 5, Ground	-	4.2	-	k Ω
	C_{in}	-	-	4.5	-	pF
Quadrature Coil Loading	R_{in}	Pin 9 to 8	-	7.6	-	k Ω
	C_{in}	-	-	5.2	-	pF

Figure 2. Test Circuit

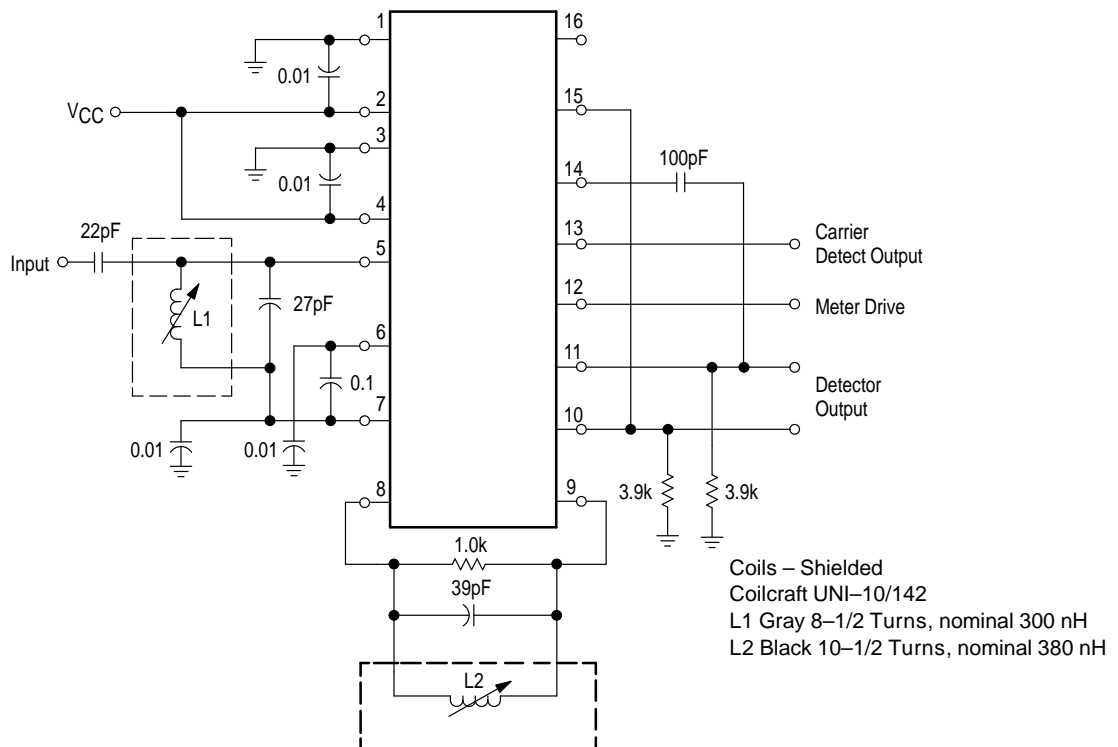

Figure 3. Overall Gain, Noise, AM Rejection

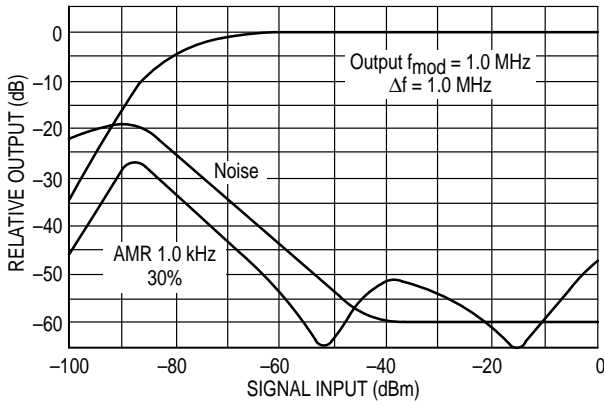

Figure 4. Meter Current versus Signal

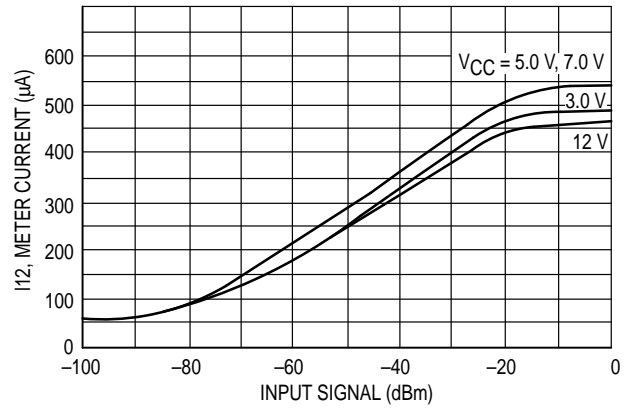

Figure 5. Untuned Input: Limiting Sensitivity versus Frequency

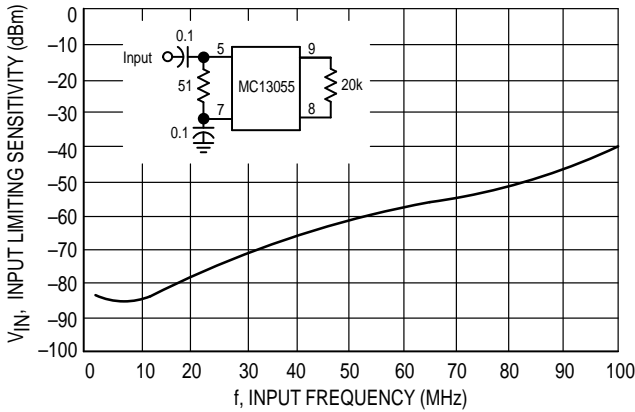

Figure 6. Untuned Input: Meter Current versus Frequency

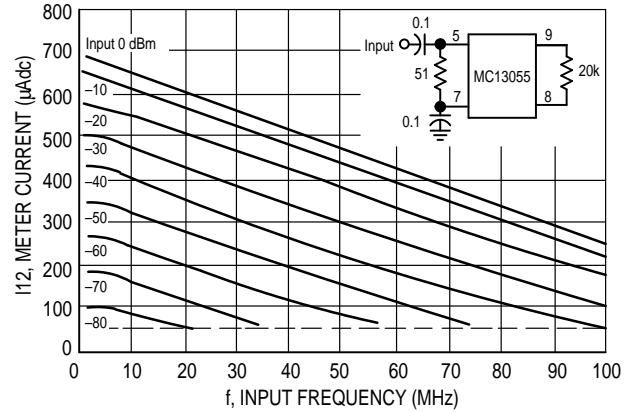

Figure 7. Limiting Sensitivity and Detuning versus Supply Voltage

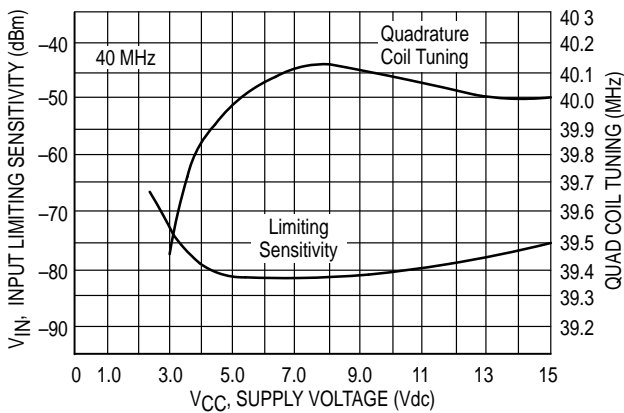
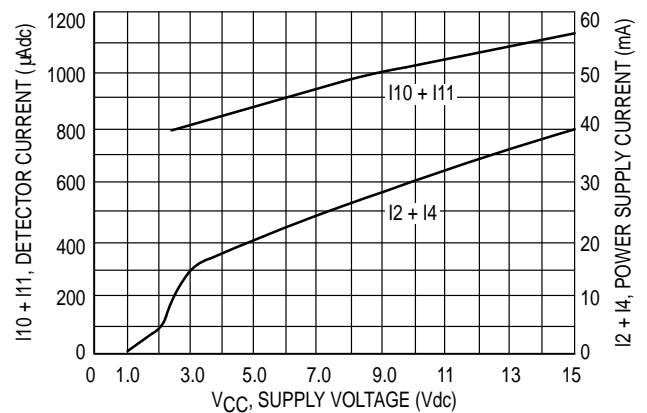

Figure 8. Detector Current and Power Supply Current versus Supply Voltage



ARCHIVE INFORMATION

ARCHIVE INFORMATION

Figure 9. Recovered Audio versus Temperature

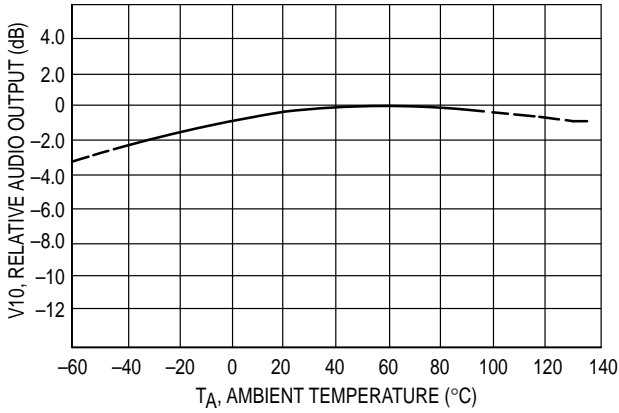

Figure 10. Carrier Detect Threshold versus Temperature

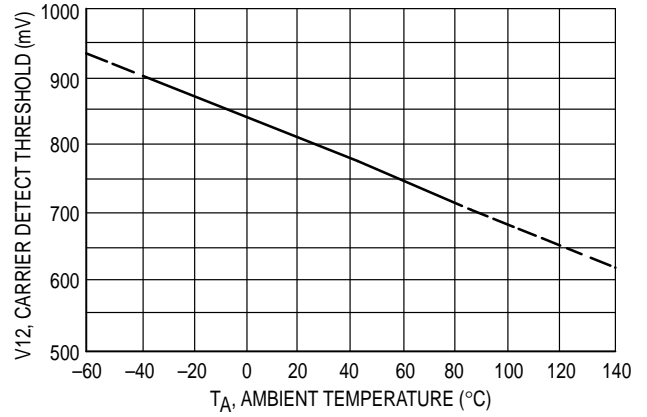

Figure 11. Meter Current versus Temperature

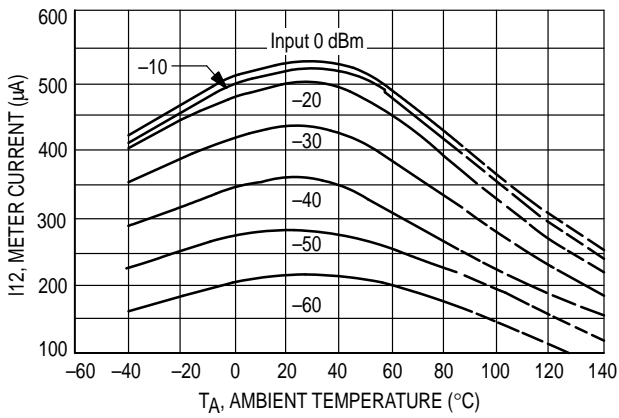

Figure 12. Input Limiting versus Temperature

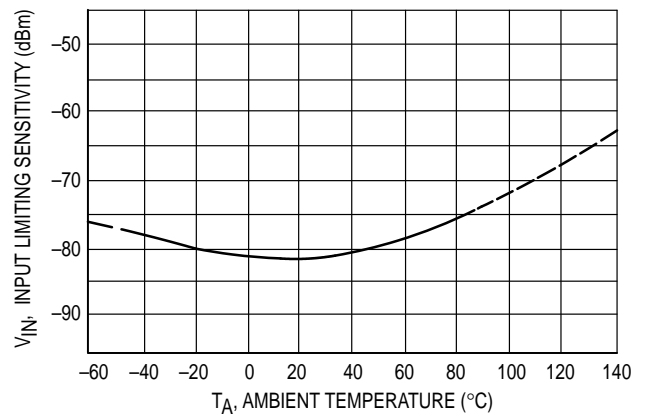
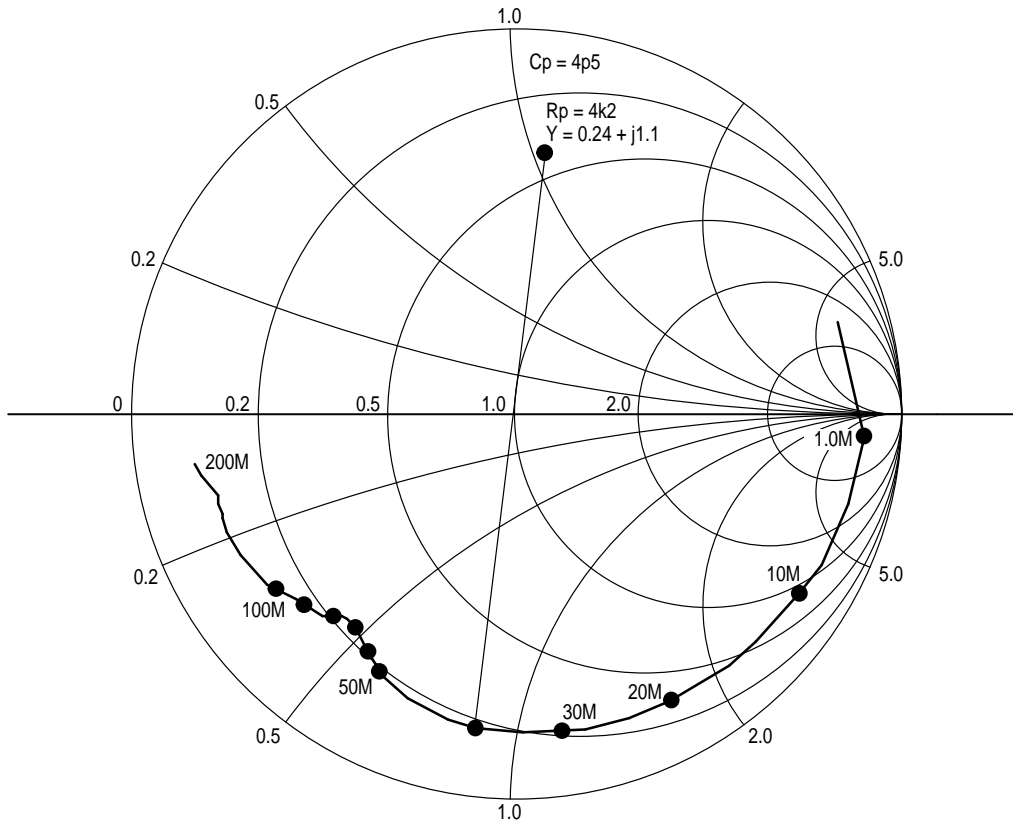

Figure 13. Input Impedance, Pin 5



ARCHIVE INFORMATION

ARCHIVE INFORMATION

MC13055

Figure 14. Test Fixture
(Component Layout)

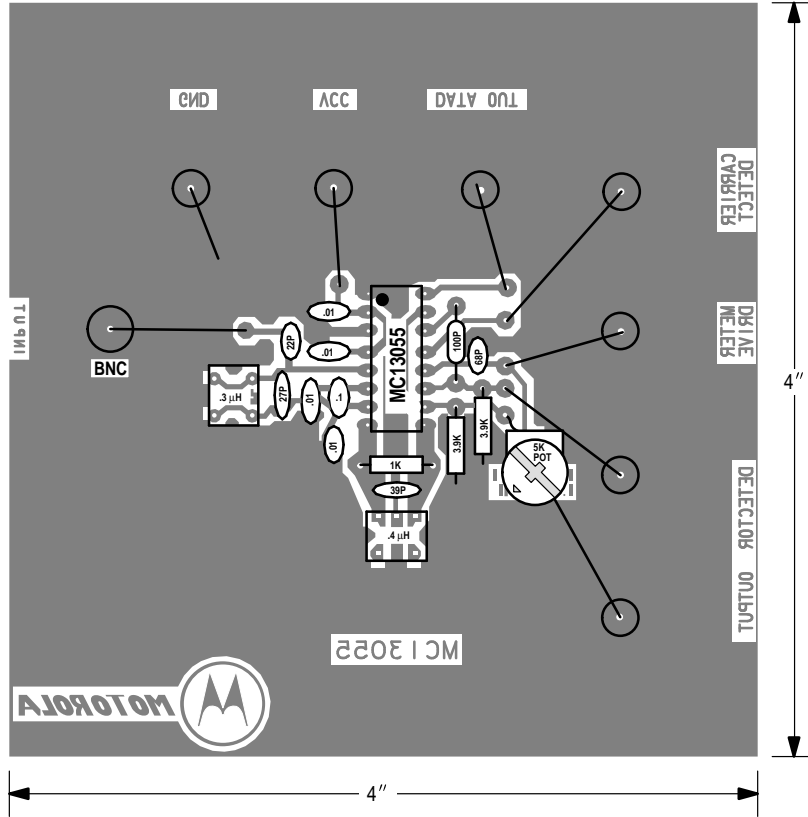

(Circuit Side View)

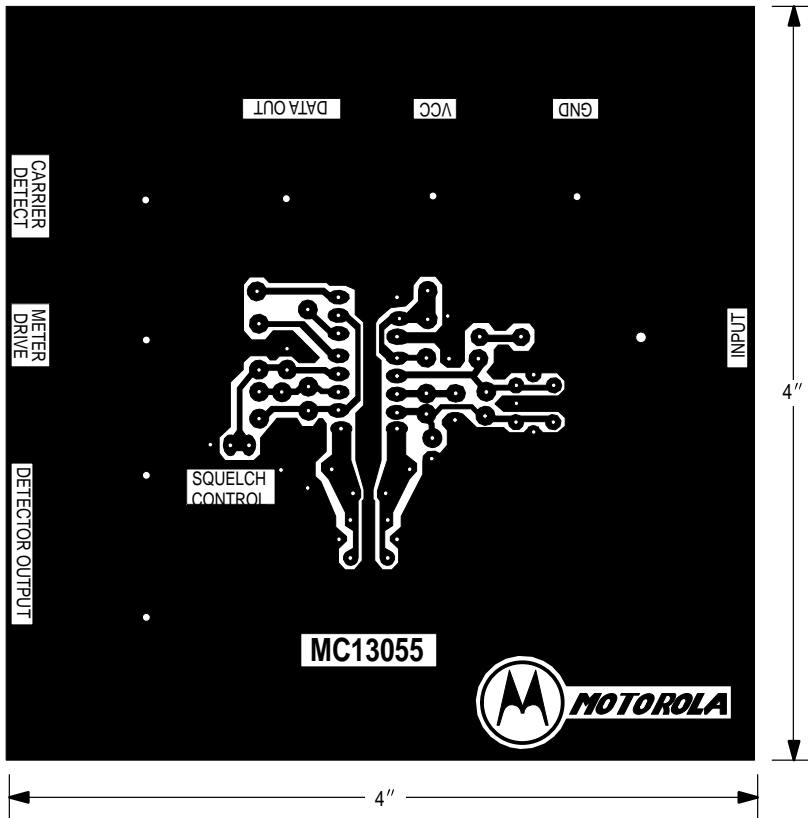

ARCHIVE INFORMATION

ARCHIVE INFORMATION

Figure 15. Internal Schematic

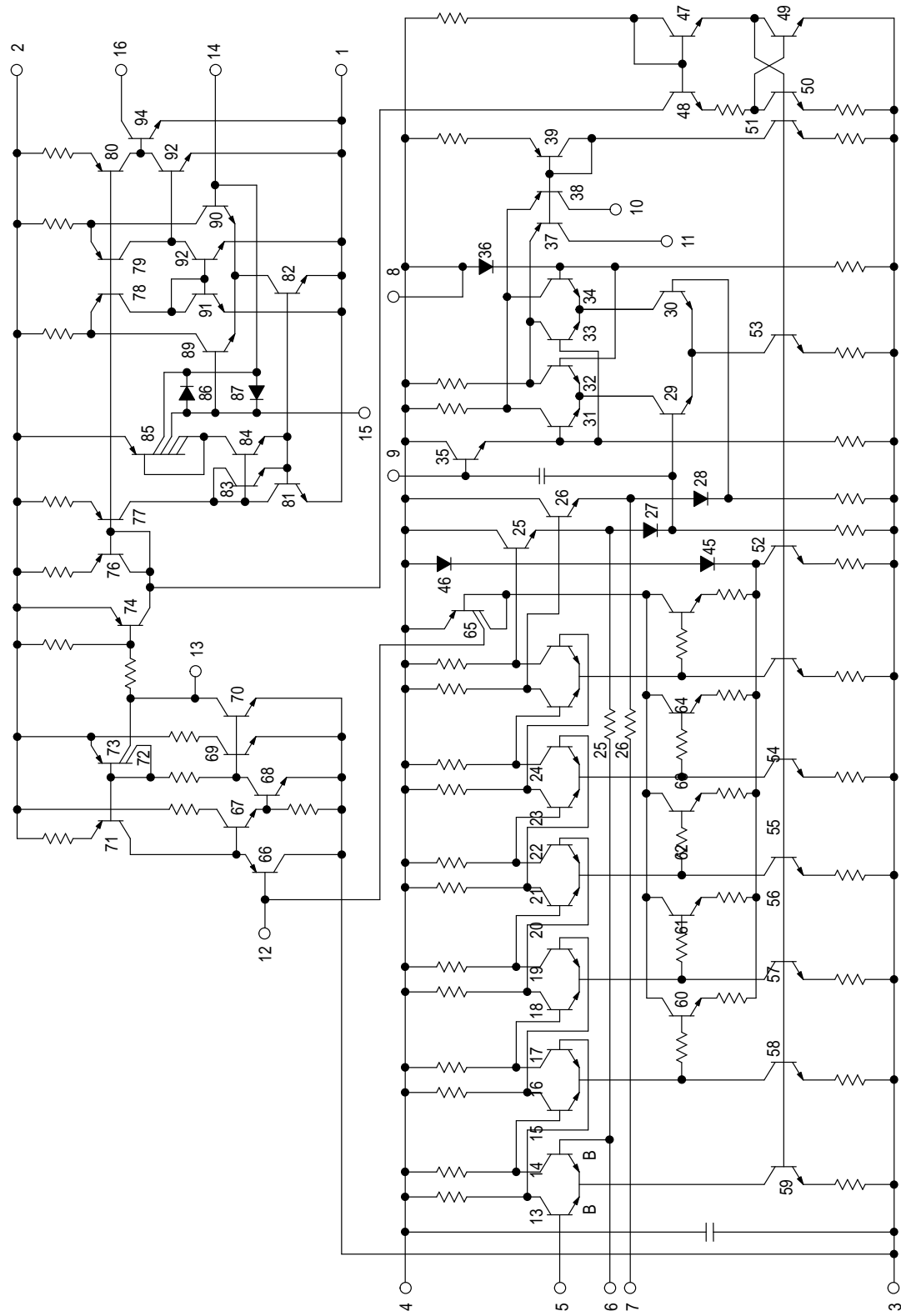

MC13055

GENERAL DESCRIPTION

The MC13055 is an extended frequency range FM IF, quadrature detector, signal strength detector and data shaper. It is intended primarily for FSK data systems. The design is very similar to MC3356 except that the oscillator/mixer has been removed, and the frequency capability of the IF has been raised about 2:1. The detector output configuration has been changed to a balanced, open-collector type to permit symmetrical drive of the data shaper (comparator). Meter drive and squelch features have been retained.

The limiting IF is a high frequency type, capable of being operated up to 100 MHz. It is expected to be used at 40 MHz in most cases. The quadrature detector is internally coupled to the IF, and a 2.0 pF quadrature capacitor is internally provided. The 20 dB quieting sensitivity is approximately 20 μ V, tuned input, and the IF can accept signals up to 220 mVrms without distortion or change of detector quiescent DC level.

The IF is unusual in that each of the last 5 stages of the 6 stage limiter contains a signal strength sensitive, current sinking device. These are parallel connected and buffered

to produce a signal strength meter drive which is fairly linear for IF input signals of 20 μ V to 20 mVrms (see Figure 4).

A simple squelch arrangement is provided whereby the meter current flowing through the meter load resistance flips a comparator at about 0.8 Vdc above ground. The signal strength at which this occurs can be adjusted by changing the meter load resistor. The comparator (+) input and output are available to permit control of hysteresis. Good positive action can be obtained for IF input signals of above 20 μ Vrms. A resistor (R) from Pin 13 to Pin 12 will provide V_{CC}/R of feedback current. This current can be correlated to an amount of signal strength hysteresis by using Figure 4.

The squelch is internally connected to the data shaper. Squelch causes the data shaper to produce a high (V_{CC}) output.

The data shaper is a complete "floating" comparator, with diodes across its inputs. The outputs of the quadrature detector can be fed directly to either or preferably both inputs of the comparator to produce a squared output swinging from V_{CC} to ground in inverted or noninverted form.

ARCHIVE INFORMATION

ARCHIVE INFORMATION

MC13055

OUTLINE DIMENSIONS

P SUFFIX PLASTIC PACKAGE CASE 648-08 ISSUE R

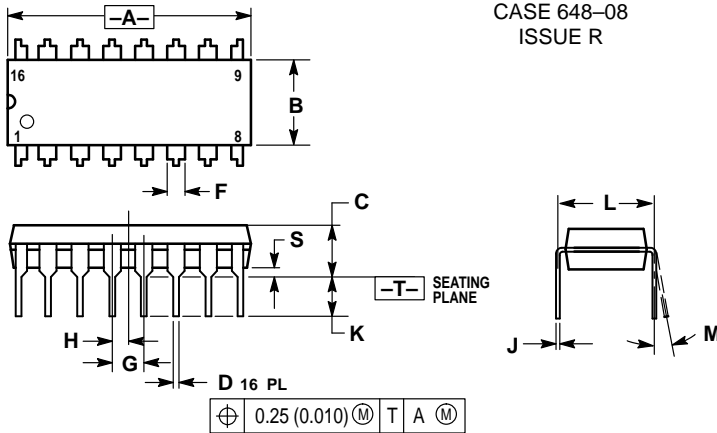

- NOTES:
1. DIMENSIONING AND TOLERANCING PER ANSI Y14.5M, 1982.
 2. CONTROLLING DIMENSION: INCH.
 3. DIMENSION L TO CENTER OF LEADS WHEN FORMED PARALLEL.
 4. DIMENSION B DOES NOT INCLUDE MOLD FLASH.
 5. ROUNDED CORNERS OPTIONAL.

DIM	INCHES		MILLIMETERS	
	MIN	MAX	MIN	MAX
A	0.740	0.770	18.80	19.55
B	0.250	0.270	6.35	6.85
C	0.145	0.175	3.69	4.44
D	0.015	0.021	0.39	0.53
F	0.040	0.70	1.02	1.77
G	0.100 BSC		2.54 BSC	
H	0.050 BSC		1.27 BSC	
J	0.008	0.015	0.21	0.38
K	0.110	0.130	2.80	3.30
L	0.295	0.305	7.50	7.74
M	0°	10°	0°	10°
S	0.020	0.040	0.51	1.01

D SUFFIX PLASTIC PACKAGE CASE 751B-05 (SO-16) ISSUE J

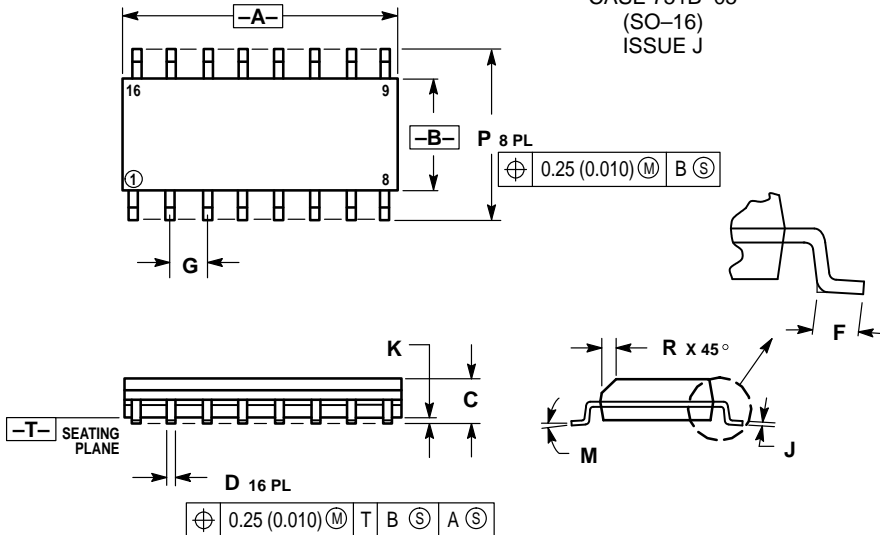

- NOTES:
1. DIMENSIONING AND TOLERANCING PER ANSI Y14.5M, 1982.
 2. CONTROLLING DIMENSION: MILLIMETER.
 3. DIMENSIONS A AND B DO NOT INCLUDE MOLD PROTRUSION.
 4. MAXIMUM MOLD PROTRUSION 0.15 (0.006) PER SIDE.
 5. DIMENSION D DOES NOT INCLUDE DAMBAR PROTRUSION. ALLOWABLE DAMBAR PROTRUSION SHALL BE 0.127 (0.005) TOTAL IN EXCESS OF THE D DIMENSION AT MAXIMUM MATERIAL CONDITION.

DIM	MILLIMETERS		INCHES	
	MIN	MAX	MIN	MAX
A	9.80	10.00	0.386	0.393
B	3.80	4.00	0.150	0.157
C	1.35	1.75	0.054	0.068
D	0.35	0.49	0.014	0.019
F	0.40	1.25	0.016	0.049
G	1.27 BSC		0.050 BSC	
J	0.19	0.25	0.008	0.009
K	0.10	0.25	0.004	0.009
M	0°	7°	0°	7°
P	5.80	6.20	0.229	0.244
R	0.25	0.50	0.010	0.019

Motorola reserves the right to make changes without further notice to any products herein. Motorola makes no warranty, representation or guarantee regarding the suitability of its products for any particular purpose, nor does Motorola assume any liability arising out of the application or use of any product or circuit, and specifically disclaims any and all liability, including without limitation consequential or incidental damages. "Typical" parameters which may be provided in Motorola data sheets and/or specifications can and do vary in different applications and actual performance may vary over time. All operating parameters, including "Typicals" must be validated for each customer application by customer's technical experts. Motorola does not convey any license under its patent rights nor the rights of others. Motorola products are not designed, intended, or authorized for use as components in systems intended for surgical implant into the body, or other applications intended to support or sustain life, or for any other application in which the failure of the Motorola product could create a situation where personal injury or death may occur. Should Buyer purchase or use Motorola products for any such unintended or unauthorized application, Buyer shall indemnify and hold Motorola and its officers, employees, subsidiaries, affiliates, and distributors harmless against all claims, costs, damages, and expenses, and reasonable attorney fees arising out of, directly or indirectly, any claim of personal injury or death associated with such unintended or unauthorized use, even if such claim alleges that Motorola was negligent regarding the design or manufacture of the part. Motorola and are registered trademarks of Motorola, Inc. Motorola, Inc. is an Equal Opportunity/Affirmative Action Employer.

Mfax is a trademark of Motorola, Inc.

How to reach us:

USA/EUROPE/Locations Not Listed: Motorola Literature Distribution;
P.O. Box 5405, Denver, Colorado 80217. 303-675-2140 or 1-800-441-2447

JAPAN: Nippon Motorola Ltd.: SPD, Strategic Planning Office, 4-32-1,
Nishi-Gotanda, Shinagawa-ku, Tokyo 141, Japan. 81-3-5487-8488

Mfax™: RMFAX0@email.sps.mot.com - TOUCHTONE 602-244-6609
- US & Canada ONLY 1-800-774-1848

ASIA/PACIFIC: Motorola Semiconductors H.K. Ltd.; 8B Tai Ping Industrial Park,
51 Ting Kok Road, Tai Po, N.T., Hong Kong. 852-26629298

INTERNET: <http://motorola.com/sps>



MC13055/D