

**MAXIM****1ppm/°C, Low-Noise, +2.5V/+4.096V/+5V  
Voltage References****General Description**

The MAX6325/MAX6341/MAX6350 are low-noise, precision voltage references with extremely low, 0.5ppm/°C typical temperature coefficients and excellent,  $\pm 0.02\%$  initial accuracy. These devices feature buried-zener technology for lowest noise performance. Load-regulation specifications are guaranteed for source and sink currents up to 15mA. Excellent line and load regulation and low output impedance at high frequencies make them ideal for high-resolution data-conversion systems up to 16 bits.

The MAX6325 is set for a 2.5V output, the MAX6341 is set for a 4.096V output, and the MAX6350 is set for a 5V output. All three provide for the option of external trimming and noise reduction.

**Applications**

High-Resolution Analog-to-Digital  
and Digital-to-Analog Converters

High-Accuracy Reference Standard

High-Accuracy Industrial and Process Control

Digital Voltmeters

ATE Equipment

Precision Current Sources

**Features**

- ◆ Ultra Low, 1ppm/°C Max Tempco
- ◆ Very Low, 1.5 $\mu$ Vp-p Noise (0.1Hz to 10Hz) (MAX6325)
- ◆  $\pm 0.02\%$  Initial Accuracy (MAX6350)
- ◆  $\pm 15$ mA Output Source and Sink Current
- ◆ Low, 18mW Power Consumption (MAX6325)
- ◆ Industry-Standard Pinout
- ◆ Optional Noise Reduction and Voltage Trim
- ◆ Excellent Transient Response
- ◆ 8-Pin SO Package Available
- ◆ Low, 30ppm/1000hr Long-Term Stability
- ◆ Stable for All Capacitive Loads

**Ordering Information**

PART	TEMP. RANGE	PIN-PACKAGE	MAX TEMPCO (ppm/°C)
MAX6325CPA	0°C to +70°C	8 Plastic DIP	1.0
MAX6325CSA	0°C to +70°C	8 SO	1.0
MAX6325EPA	-40°C to +85°C	8 Plastic DIP	1.5
MAX6325ESA	-40°C to +85°C	8 SO	1.5
MAX6325MJA	-55°C to +125°C	8 CERDIP	2.5

Ordering Information continued at end of data sheet.

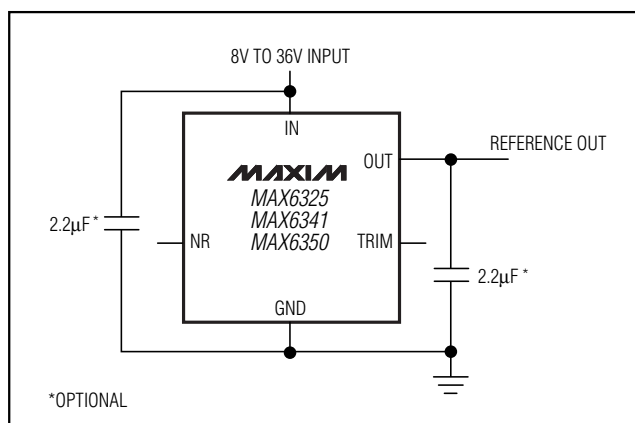
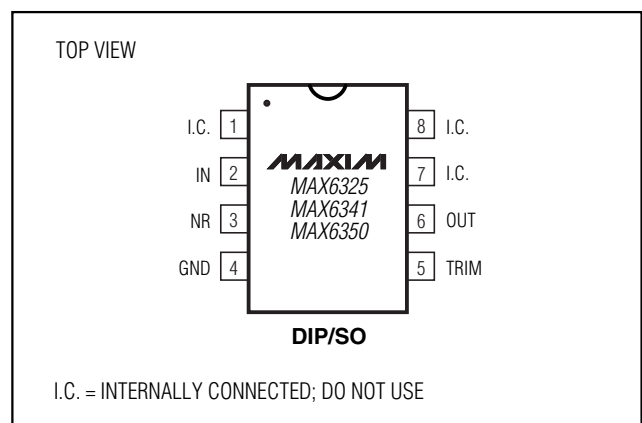
**Typical Operating Circuit****Pin Configuration****MAXIM**

Maxim Integrated Products 1

**For pricing, delivery, and ordering information, please contact Maxim/Dallas Direct! at 1-888-629-4642, or visit Maxim's website at [www.maxim-ic.com](http://www.maxim-ic.com).**

**MAX6325/MAX6341/MAX6350**

# 1ppm/°C, Low-Noise, +2.5V/+4.096V/+5V Voltage References

## ABSOLUTE MAXIMUM RATINGS

(Voltages Referenced to GND)

IN	-0.3V to 40V
OUT, TRIM	-0.3V to 12V
NR	-0.3V to 6V
OUT Short-Circuit to GND Duration ( $V_{IN} \leq 12V$ )	Continuous
OUT Short-Circuit to GND Duration ( $V_{IN} \leq 40V$ )	5s
OUT Short-Circuit to IN Duration ( $V_{IN} \leq 12V$ )	Continuous
Continuous Power Dissipation ( $T_A = +70^\circ\text{C}$ )	
8-Pin Plastic DIP (derate 9.09mW/°C above +70°C)	727mW

8-Pin SO (derate 5.88mW/°C above +70°C)	471mW
8-Pin CERDIP (derate 8.00mW/°C above +70°C)	640mW
Operating Temperature Ranges	
MAX63_C_A	0°C to +70°C
MAX63_E_A	-40°C to +85°C
MAX63_MJA	-55°C to +125°C
Storage Temperature Range	-65°C to +150°C
Lead Temperature (soldering, 10s)	+300°C

Stresses beyond those listed under "Absolute Maximum Ratings" may cause permanent damage to the device. These are stress ratings only, and functional operation of the device at these or any other conditions beyond those indicated in the operational sections of the specifications is not implied. Exposure to absolute maximum rating conditions for extended periods may affect device reliability.

## ELECTRICAL CHARACTERISTICS—MAX6325

( $V_{IN} = +10V$ ,  $I_{OUT} = 0mA$ ,  $T_A = T_{MIN}$  to  $T_{MAX}$ , unless otherwise noted. Typical values are at  $T_A = +25^\circ\text{C}$ .)

PARAMETER	SYMBOL	CONDITIONS	$T_A$	MIN	TYP	MAX	UNITS
Input Voltage Range	$V_{IN}$		C, E, M	8		36	V
Output Voltage	$V_{OUT}$	MAX6325	+25°C	2.499	2.500	2.501	V
Output Voltage Temperature Coefficient (Note 1)	$TCV_{OUT}$	MAX6325C_A	C		0.5	1.0	ppm/°C
		MAX6325E_A	E		0.75	1.5	
		MAX6325MJA	M		1.0	2.5	
Line Regulation (Note 2)	$\Delta V_{OUT}/\Delta V_{IN}$	$8V \leq V_{IN} \leq 10V$	+25°C		10	18	ppm/V
			C			30	
			E			35	
		$10V \leq V_{IN} \leq 36V$	M			45	
			+25°C		2	5	
			C			7	
Load Regulation (Note 2)	$\Delta V_{OUT}/\Delta I_{OUT}$	Sourcing: $0mA \leq I_{OUT} \leq 15mA$	C		1	6	ppm/mA
			E		1	7	
			M		3	15	
		Sinking: $-15mA \leq I_{OUT} \leq 0mA$	C		1	6	
			E		1	7	
			M		10	30	
Supply Current	$I_{IN}$		+25°C		1.8	2.7	mA
			C, E, M			3.0	
Trim-Adjustment Range	$\Delta V_{OUT}$	(Figure 1)	C, E, M	±15	±25		mV
Turn-On Settling Time	$t_{ON}$	To ±0.01% of final value	+25°C		5		µs
Output Noise Voltage (Note 3)	$e_n$	$0.1\text{Hz} \leq f \leq 10\text{Hz}$	+25°C		1.5		µVp-p
		$10\text{Hz} \leq f \leq 1\text{kHz}$	+25°C		1.3	2.8	µVRMS
Temperature Hysteresis		(Note 4)	+25°C		20		ppm
Long-Term Stability	$\Delta V_{OUT}/t$		+25°C		30		ppm/1000hr

# 1ppm/°C, Low-Noise, +2.5V/+4.096V/+5V Voltage References

## ELECTRICAL CHARACTERISTICS—MAX6341

( $V_{IN} = +10V$ ,  $I_{OUT} = 0mA$ ,  $T_A = T_{MIN}$  to  $T_{MAX}$ , unless otherwise noted. Typical values are at  $T_A = +25°C$ .)

PARAMETER	SYMBOL	CONDITIONS	$T_A$	MIN	TYP	MAX	UNITS
Input Voltage Range	$V_{IN}$		C, E, M	8		36	V
Output Voltage	$V_{OUT}$	MAX6341	+25°C	4.095	4.096	4.097	V
Output Voltage Temperature Coefficient (Note 1)	$TCV_{OUT}$	MAX6341C_A	C		0.5	1.0	ppm/°C
		MAX6341E_A	E		0.75	1.5	
		MAX6341MJA	M		1.0	2.5	
Line Regulation (Note 2)	$\frac{\Delta V_{OUT}}{\Delta V_{IN}}$	$8V \leq V_{IN} \leq 10V$	+25°C		10	18	ppm/V
			C			30	
			E			35	
		$10V \leq V_{IN} \leq 36V$	+25°C		2	5	
			C			7	
			E			8	
Load Regulation (Note 2)	$\frac{\Delta V_{OUT}}{\Delta I_{OUT}}$	Sourcing: $0mA \leq I_{OUT} \leq 15mA$	C		1	6	ppm/mA
			E		1	7	
			M		3	9	
		Sinking: $-15mA \leq I_{OUT} \leq 0mA$	C		1	6	
			E		1	7	
			M		7	18	
Supply Current	$I_{IN}$		+25°C		1.9	2.9	mA
			C, E, M			3.2	
Trim-Adjustment Range	$\Delta V_{OUT}$	(Figure 1)	C, E, M	±24	±40		mV
Turn-On Settling Time	$t_{ON}$	To ±0.01% of final value	+25°C		8		µs
Output Noise Voltage (Note 3)	$e_n$	$0.1Hz \leq f \leq 10Hz$	+25°C		2.4		µVp-p
		$10Hz \leq f \leq 1kHz$	+25°C		2.0	4.0	µVRMS
Temperature Hysteresis		(Note 4)	+25°C		20		ppm
Long-Term Stability	$\Delta V_{OUT}/t$		+25°C		30		ppm/1000hr

MAX6325/MAX6341/MAX6350

# 1ppm/°C, Low-Noise, +2.5V/+4.096V/+5V Voltage References

## ELECTRICAL CHARACTERISTICS—MAX6350

( $V_{IN} = +10V$ ,  $I_{OUT} = 0mA$ ,  $T_A = T_{MIN}$  to  $T_{MAX}$ , unless otherwise noted. Typical values are at  $T_A = +25°C$ .)

PARAMETER	SYMBOL	CONDITIONS	$T_A$	MIN	TYP	MAX	UNITS
Input Voltage Range	$V_{IN}$		C, E, M	8		36	V
Output Voltage	$V_{OUT}$	MAX6350	+25°C	4.999	5.000	5.001	V
Output Voltage Temperature Coefficient (Note 1)	$TCV_{OUT}$	MAX6350C_A	C		0.5	1.0	ppm/°C
		MAX6350E_A	E		0.75	1.5	
		MAX6350MJA	M		1.0	2.5	
Line Regulation (Note 2)	$\Delta V_{OUT} / \Delta V_{IN}$	$8V \leq V_{IN} \leq 10V$	+25°C		10	18	ppm/V
			C			30	
			E			35	
			M			45	
		$10V \leq V_{IN} \leq 36V$	+25°C		2	5	
			C			7	
			E			8	
Load Regulation (Note 2)	$\Delta V_{OUT} / \Delta I_{OUT}$	Sourcing: $0mA \leq I_{OUT} \leq 15mA$	C		1	6	ppm/mA
			E		1	7	
			M		2	9	
		Sinking: $-15mA \leq I_{OUT} \leq 0mA$	C		1	6	
			E		1	7	
			M		6	15	
Supply Current	$I_{IN}$		+25°C		2.0	3.0	mA
			C, E, M			3.3	
Trim-Adjustment Range	$\Delta V_{OUT}$	(Figure 1)	C, E, M	±30	±50		mV
Turn-On Settling Time	$t_{ON}$	To ±0.01% of final value	+25°C		10		µs
Output Noise Voltage (Note 3)	$e_n$	$0.1Hz \leq f \leq 10Hz$	+25°C		3.0		µVp-p
		$10Hz \leq f \leq 1kHz$	+25°C		2.5	5.0	µVRMS
Temperature Hysteresis		(Note 4)	+25°C		20		ppm
Long-Term Stability	$\Delta V_{OUT}/t$		+25°C		30		ppm/1000hr

**Note 1:** Temperature coefficient is measured by the box method; i.e., the maximum  $\Delta V_{OUT}$  is divided by  $\Delta T \times V_{OUT}$ .

**Note 2:** Line regulation ( $\Delta V_{OUT} / (V_{OUT} \times \Delta V_{IN})$ ) and load regulation ( $\Delta V_{OUT} / (V_{OUT} \times \Delta I_{OUT})$ ) are measured with pulses and do not include output voltage changes due to die-temperature changes.

**Note 3:** Noise specifications are guaranteed by design.

**Note 4:** Temperature hysteresis is specified at  $T_A = +25°C$  by measuring  $V_{OUT}$  before and after changing temperature by +25°C, using the plastic DIP package.

# 1ppm/°C, Low-Noise, +2.5V/+4.096V/+5V Voltage References

## Typical Operating Characteristics

( $V_{IN} = +10V$ ,  $I_{OUT} = 0mA$ ,  $T_A = +25^\circ C$ , unless otherwise noted.)

MAX6325/MAX6341/MAX6350

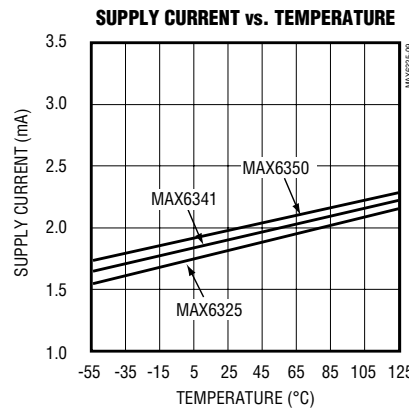
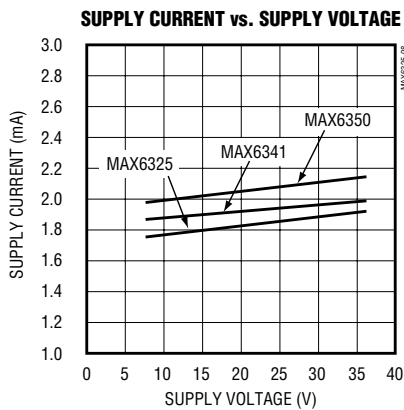
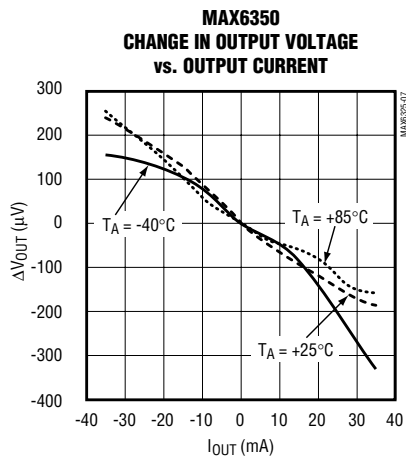
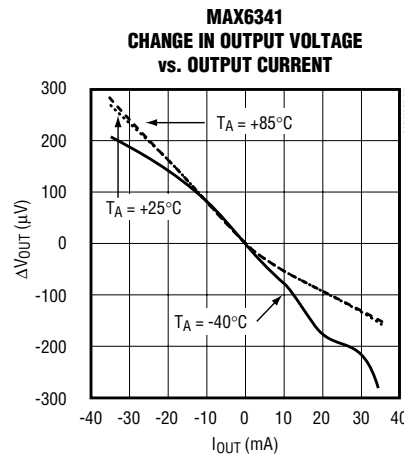
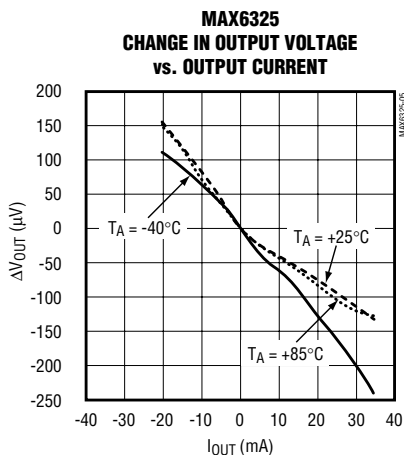
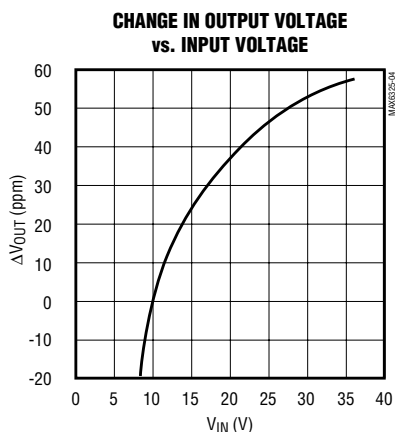
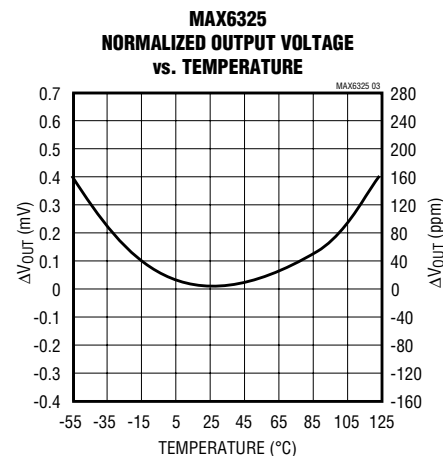
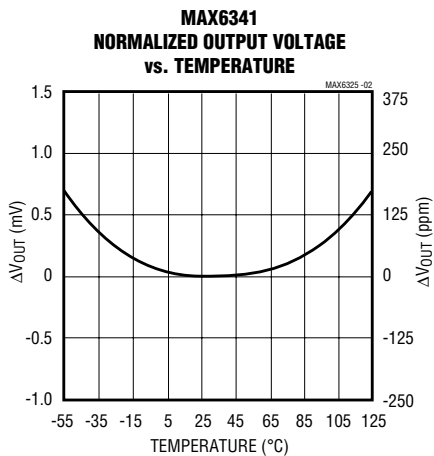
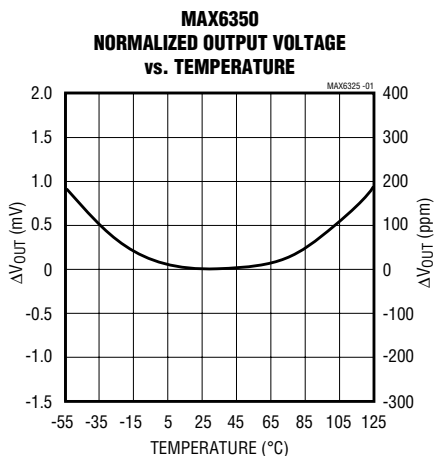

# 1ppm/°C, Low-Noise, +2.5V/+4.096V/+5V Voltage References

## Typical Operating Characteristics (continued)

( $V_{IN} = +10V$ ,  $I_{OUT} = 0mA$ ,  $T_A = +25^\circ C$ , unless otherwise noted.)

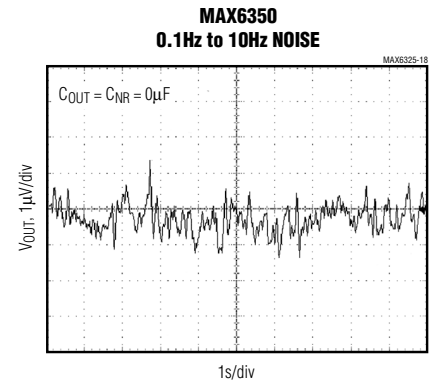
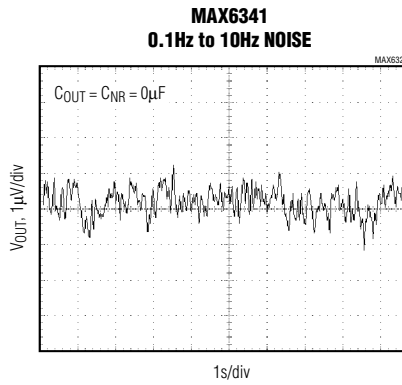
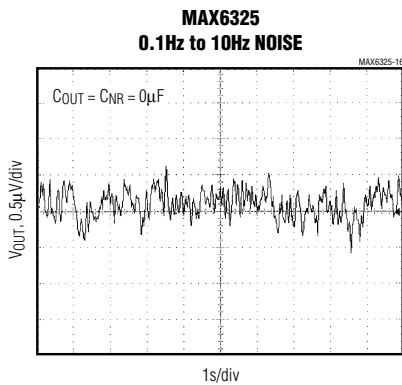
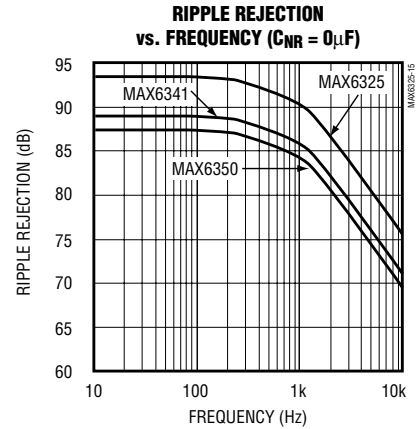
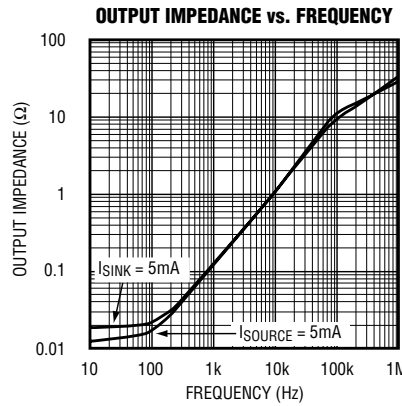
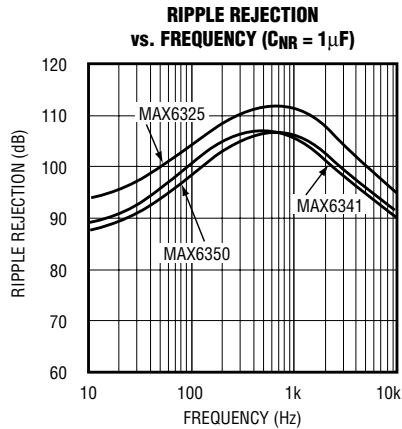
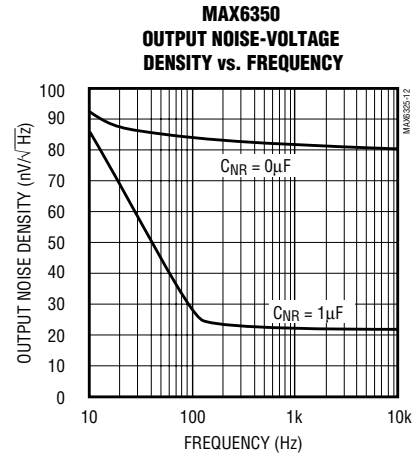
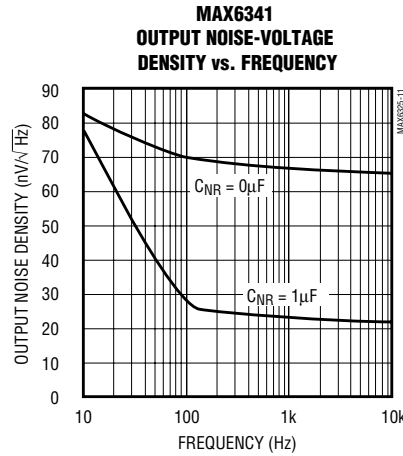
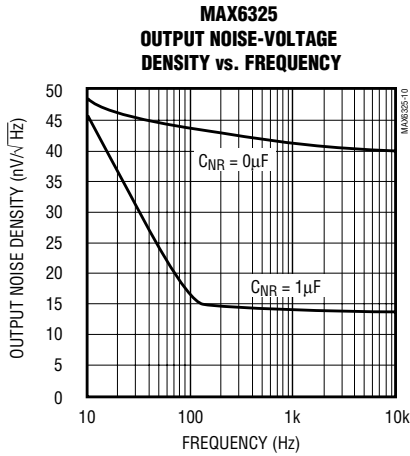

# 1ppm/°C, Low-Noise, +2.5V/+4.096V/+5V Voltage References

## Typical Operating Characteristics (continued)

( $V_{IN} = +10V$ ,  $I_{OUT} = 0mA$ ,  $T_A = +25^\circ C$ , unless otherwise noted.)

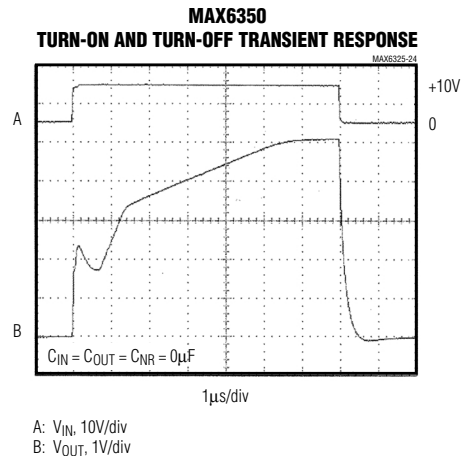
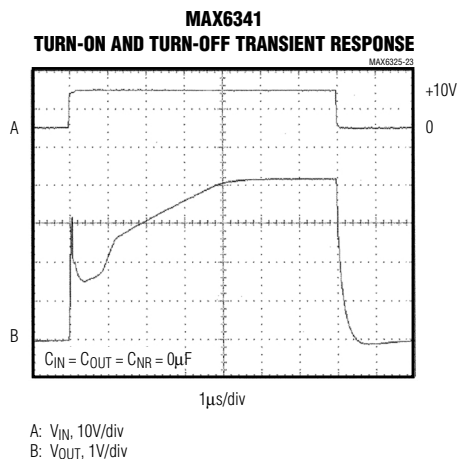
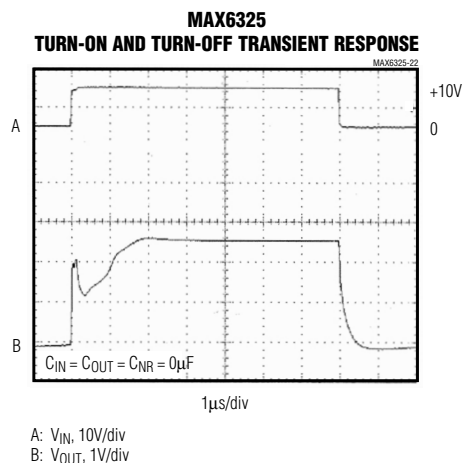
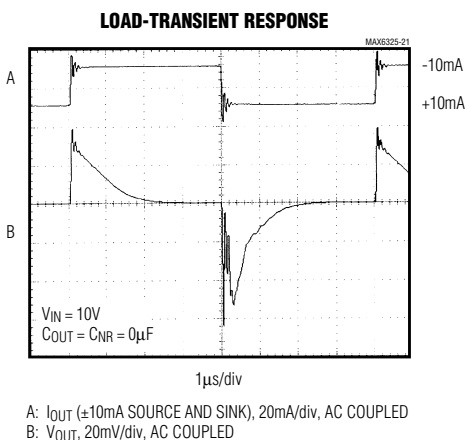
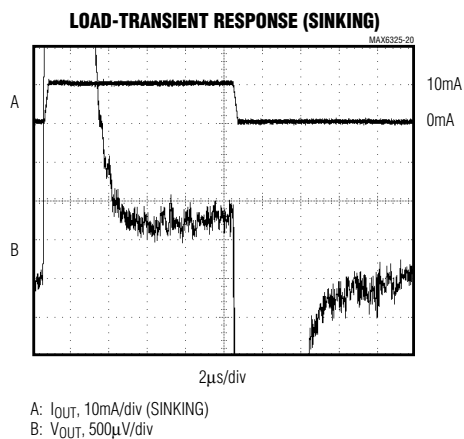
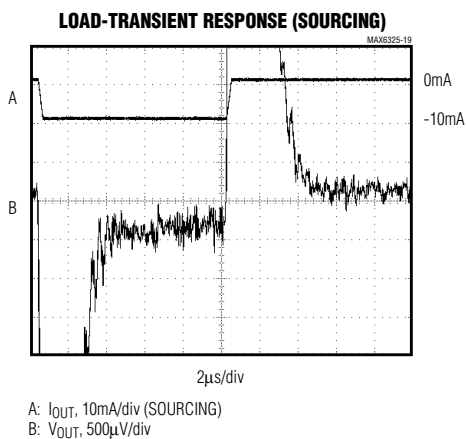

MAX6325/MAX6341/MAX6350

# 1ppm/°C, Low-Noise, +2.5V/+4.096V/+5V Voltage References

## Pin Description

PIN	NAME	FUNCTION
1, 7, 8	I.C.	Internally Connected. <b>Do not use.</b>
2	IN	Positive Power-Supply Input
3	NR	Noise Reduction. Optional capacitor connection for wideband noise reduction. Leave open if not used (Figure 2).
4	GND	Ground
5	TRIM	External Trim Input. Allows $\pm 1\%$ output adjustment (Figure 1). Leave open if not used.
6	OUT	Voltage Reference Output

## Detailed Description

### Temperature Stability

The MAX6325/MAX6341/MAX6350 are highly stable, low-noise voltage references that use a low-power temperature-compensation scheme to achieve laboratory-standard temperature stability. This produces a nearly flat temperature curve, yet does not require the power associated with heated references.

The output voltage can be trimmed a minimum of 0.6% by connecting a 10k $\Omega$  potentiometer between OUT and GND, and connecting its tap to the TRIM pin, as shown in Figure 1. The external trimming does not affect temperature stability.

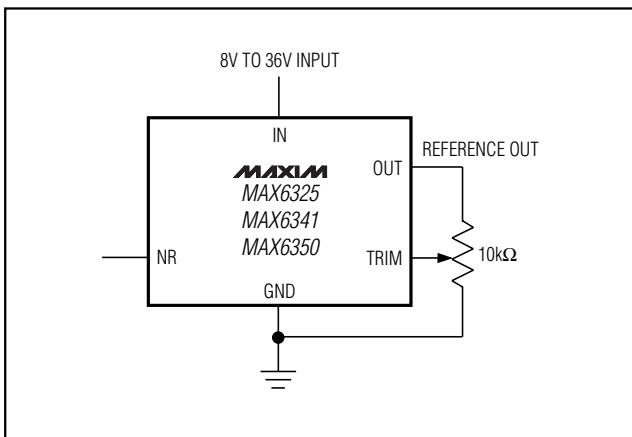

Figure 1. Output Voltage Adjustment

### Noise Reduction

To augment wideband noise reduction, add a 1 $\mu$ F capacitor to the NR pin (Figure 2). Larger values do not improve noise appreciably (see *Typical Operating Characteristics*).

Noise in the power-supply input can affect output noise, but can be reduced by adding an optional bypass capacitor to the IN pin and GND.

### Bypassing

The MAX6325/MAX6341/MAX6350 are stable with capacitive load values from 0 $\mu$ F to 100 $\mu$ F, for all values of load current. Adding an output bypass capacitor can help reduce noise and output glitching caused by load transients.

## Applications Information

### Negative Regulator

Figure 3 shows how both a +5V and -5V precision reference can be obtained from a single, unregulated +5V supply. A MAX865 generates approximately  $\pm 9V$  to operate the MAX6350 reference and MAX400 inverting amplifier. The +5V is inverted by the ultra-low offset MAX400 op amp. Resistor R1 is optional, and may be used to trim the  $\pm 5V$  references. R2 and R4 should be matched, both in absolute resistance and temperature coefficient. R3 is optional, and is adjusted to set the -5V reference.

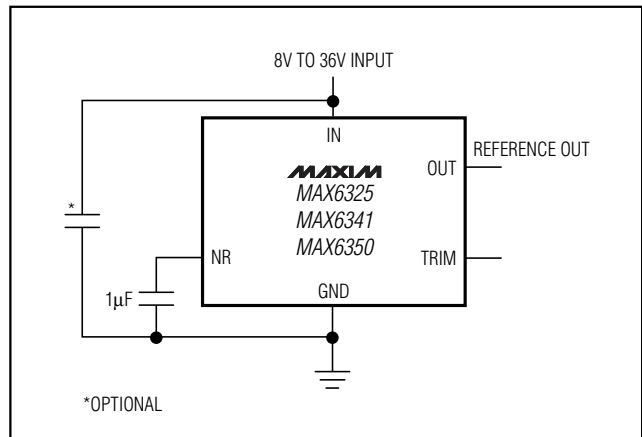

Figure 2. Noise-Reduction Capacitor



# 1ppm/°C, Low-Noise, +2.5V/+4.096V/+5V Voltage References

MAX6325/MAX6341/MAX6350

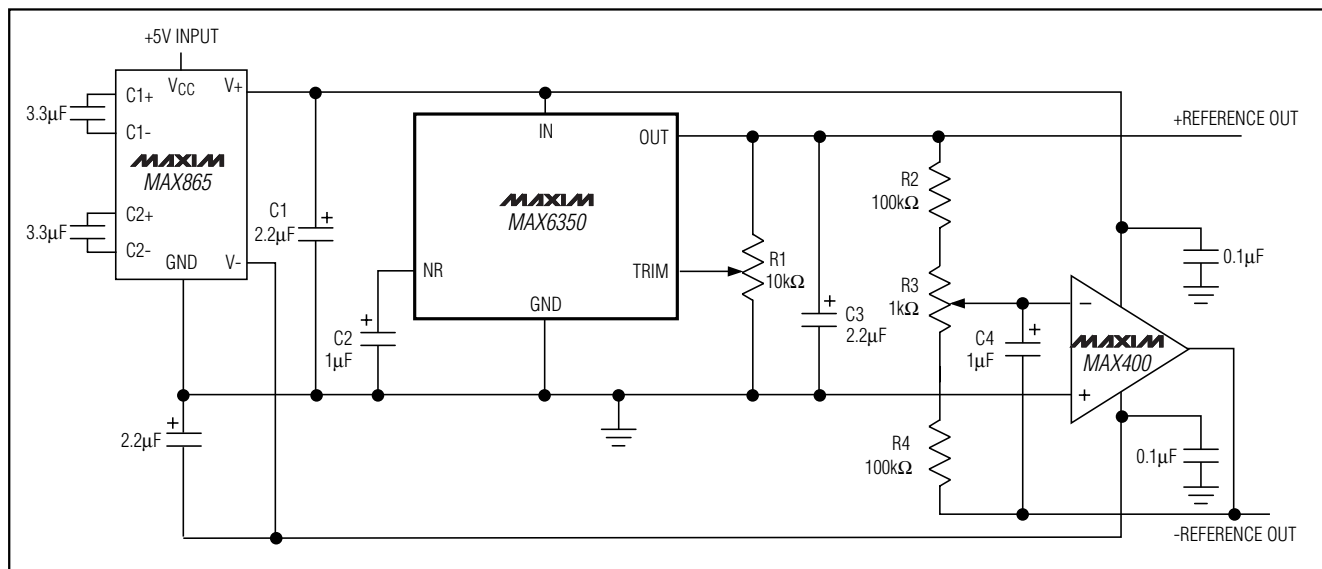

Figure 3. +5V and -5V References from a Single +5V Supply

## Ordering Information (continued)

## Chip Information

PART	TEMP. RANGE	PIN-PACKAGE	MAX. TEMPCO (ppm/°C)
<b>MAX6341</b> CPA	0°C to +70°C	8 Plastic DIP	1.0
MAX6341CSA	0°C to +70°C	8 SO	1.0
MAX6341EPA	-40°C to +85°C	8 Plastic DIP	1.5
MAX6341ESA	-40°C to +85°C	8 SO	1.5
MAX6341MJA	-55°C to +125°C	8 CERDIP	2.5
<b>MAX6350</b> CPA	0°C to +70°C	8 Plastic DIP	1.0
MAX6350CSA	0°C to +70°C	8 SO	1.0
MAX6350EPA	-40°C to +85°C	8 Plastic DIP	1.5
MAX6350ESA	-40°C to +85°C	8 SO	1.5
MAX6350MJA	-55°C to +125°C	8 CERDIP	2.5

TRANSISTOR COUNT: 435

# 1ppm/°C, Low-Noise, +2.5V/+4.096V/+5V Voltage References

## Package Information

INCHES				MILLIMETERS			
	MIN	MAX		MIN	MAX		
A	0.053	0.069	1.35	1.75			
A1	0.004	0.010	0.10	0.25			
B	0.014	0.019	0.35	0.49			
C	0.007	0.010	0.19	0.25			
e	0.050		1.27				
E	0.150	0.157	3.80	4.00			
H	0.228	0.244	5.80	6.20			
h	0.010	0.020	0.25	0.50			
L	0.016	0.050	0.40	1.27			

INCHES				MILLIMETERS			
	MIN	MAX		MIN	MAX	N	MS012
D	0.189	0.197	4.80	5.00	8	A	
D	0.337	0.344	8.55	8.75	14	B	
D	0.386	0.394	9.80	10.00	16	C	

NOTES:  
 1. D&E DO NOT INCLUDE MOLD FLASH  
 2. MOLD FLASH OR PROTRUSIONS NOT TO EXCEED .15mm (.006")  
 3. LEADS TO BE COPLANAR WITHIN .102mm (.004")  
 4. CONTROLLING DIMENSION: MILLIMETER  
 5. MEETS JEDEC MS012-XX AS SHOWN IN ABOVE TABLE  
 6. N = NUMBER OF PINS

MAXIM PACKAGE FAMILY OUTLINE: SOIC .150" 1/1 21-0041 A

INCHES				MILLIMETERS			
	MIN	MAX		MIN	MAX	N	MS001
A	---	0.200	---	5.08			
A1	0.015	---	0.38	---			
A2	0.125	0.175	3.18	4.45			
A3	0.055	0.080	1.40	2.03			
B	0.016	0.022	0.41	0.56			
B1	0.045	0.065	1.14	1.65			
C	0.008	0.012	0.20	0.30			
D1	0.005	0.080	0.13	2.03			
E	0.300	0.325	7.62	8.26			
E1	0.240	0.310	6.10	7.87			
e	0.100	---	2.54	---			
eA	0.300	---	7.62	---			
eB	---	0.400	---	10.16			
L	0.115	0.150	2.92	3.81			

INCHES				MILLIMETERS			
	MIN	MAX		MIN	MAX	N	MS001
D	0.348	0.390	8.84	9.91	8	AB	
D	0.735	0.765	18.67	19.43	14	AC	
D	0.745	0.765	18.92	19.43	16	AA	
D	0.885	0.915	22.48	23.24	18	AD	
D	1.015	1.045	25.78	26.54	20	AE	
D	1.14	1.265	28.96	32.13	24	AF	
D	1.360	1.380	34.54	35.05	28	AS	

NOTES:  
 1. D&E DO NOT INCLUDE MOLD FLASH  
 2. MOLD FLASH OR PROTRUSIONS NOT TO EXCEED .15mm (.006")  
 3. CONTROLLING DIMENSION: MILLIMETER  
 4. MEETS JEDEC MS001-XX AS SHOWN IN ABOVE TABLE  
 5. SIMILAR TO JEDEC MO-058AB  
 6. N = NUMBER OF PINS

MAXIM PACKAGE FAMILY OUTLINE: PDIP .300" 1/1 21-0043 A

# 1ppm/°C, Low-Noise, +2.5V/+4.096V/+5V Voltage References

## Package Information (continued)

MAX6325/MAX6341/MAX6350

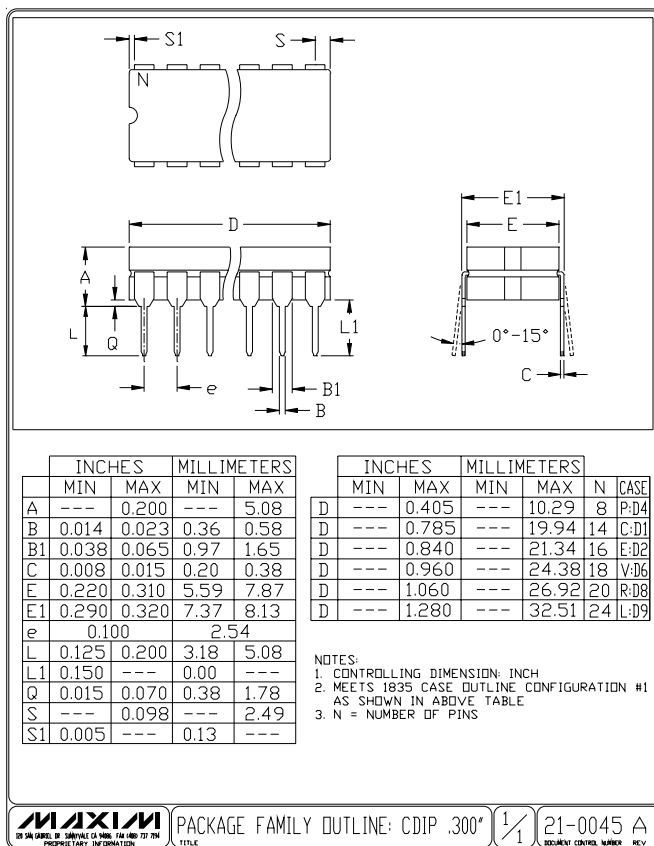

PACKAGE FAMILY OUTLINE: CDIP .300\*

21-0045 A

Maxim cannot assume responsibility for use of any circuitry other than circuitry entirely embodied in a Maxim product. No circuit patent licenses are implied. Maxim reserves the right to change the circuitry and specifications without notice at any time.

Maxim Integrated Products, 120 San Gabriel Drive, Sunnyvale, CA 94086 (408) 737-7600 11

© 2001 Maxim Integrated Products Printed USA MAXIM is a registered trademark of Maxim Integrated Products.