



# BIPOLAR ANALOG INTEGRATED CIRCUIT

## $\mu$ PC2745TB, $\mu$ PC2746TB

### 3 V, SUPER MINIMOLD SILICON MMIC WIDEBAND AMPLIFIER FOR MOBILE COMMUNICATIONS

#### DESCRIPTION

The  $\mu$ PC2745TB and  $\mu$ PC2746TB are silicon monolithic integrated circuits designed as buffer amplifier for mobile communications. These low current amplifiers operate on 3.0 V (1.8 V MIN.).

These ICs are manufactured using our 20 GHz fr NESATIII silicon bipolar process. This process uses silicon nitride passivation film and gold electrodes. These materials can protect chip surface from external pollution and prevent corrosion/migration. Thus, these IC have excellent performance, uniformity and reliability.

#### FEATURES

- Supply voltage : Recommended  $V_{CC} = 2.7$  to 3.3 V  
Circuit operation  $V_{CC} = 1.8$  to 3.3 V
- Upper limit operating frequency :  $\mu$ PC2745TB;  $f_u = 2.7$  GHz TYP. @3 dB bandwidth  
 $\mu$ PC2746TB;  $f_u = 1.5$  GHz TYP. @3 dB bandwidth
- High isolation :  $\mu$ PC2745TB; ISL = 38 dB TYP. @f = 500 MHz  
 $\mu$ PC2746TB; ISL = 45 dB TYP. @f = 500 MHz
- Power gain :  $\mu$ PC2745TB;  $G_P = 12$  dB TYP. @f = 500 MHz  
 $\mu$ PC2746TB;  $G_P = 19$  dB TYP. @f = 500 MHz
- Saturated output power :  $\mu$ PC2745TB;  $P_{O(sat)} = -1$  dBm TYP. @f = 500 MHz  
 $\mu$ PC2746TB;  $P_{O(sat)} = 0$  dBm TYP. @f = 500 MHz
- High-density surface mounting : 6-pin super minimold package (2.0 × 1.25 × 0.9 mm)

#### APPLICATIONS

- 1.5 GHz to 2.5 GHz communication system :  $\mu$ PC2745TB
- 800 MHz to 900 MHz communication system :  $\mu$ PC2746TB

#### ORDERING INFORMATION

Part Number	Package	Marking	Supplying Form
$\mu$ PC2745TB-E3-A	6-pin super minimold	C1Q	• Embossed tape 8 mm wide • 1, 2, 3 pins face the perforation side of the tape • Qty 3 kpcs/reel
$\mu$ PC2746TB-E3-A		C1R	

**Remark** To order evaluation samples, contact your nearby sales office.  
Part number for sample order:  $\mu$ PC2745TB-A,  $\mu$ PC2746TB-A

**Caution** Observe precautions when handling because these devices are sensitive to electrostatic discharge.

The information in this document is subject to change without notice. Before using this document, please confirm that this is the latest version.

**PIN CONNECTION**

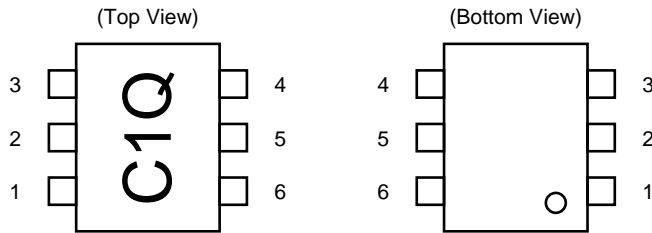

Marking is an example of  $\mu$ PC2745TB

Pin No.	Pin Name
1	INPUT
2	GND
3	GND
4	OUTPUT
5	GND
6	V <sub>CC</sub>

**PRODUCT LINE-UP (T<sub>A</sub> = +25°C, V<sub>CC</sub> = 3.0 V, Z<sub>s</sub> = Z<sub>L</sub> = 50 Ω)**

Part No.	f <sub>u</sub> (GHz)	P <sub>O(sat)</sub> (dBm)	G <sub>p</sub> (dB)	NF (dB)	I <sub>CC</sub> (mA)	Package	Making
$\mu$ PC2745T	2.7	-1.0	12	6.0	7.5	6-pin minimold	C1Q
$\mu$ PC2745TB						6-pin super minimold	
$\mu$ PC2746T	1.5	0	19	4.0	7.5	6-pin minimold	C1R
$\mu$ PC2746TB						6-pin super minimold	
$\mu$ PC2747T	1.8	-7.0	12	3.3	5.0	6-pin minimold	C1S
$\mu$ PC2747TB						6-pin super minimold	
$\mu$ PC2748T	0.2 to 1.5	-3.5	19	2.8	6.0	6-pin minimold	C1T
$\mu$ PC2748TB						6-pin super minimold	
$\mu$ PC2749T	2.9	-6.0	16	4.0	6.0	6-pin minimold	C1U
$\mu$ PC2749TB						6-pin super minimold	

**Remark** Typical performance. Please refer to **ELECTRICAL CHARACTERISTICS** in detail.

**Caution** The package size distinguish between minimold and super minimold.

**SYSTEM APPLICATION EXAMPLE**

**DIGITAL CELLULAR SYSTEM BLOCK DIAGRAM**

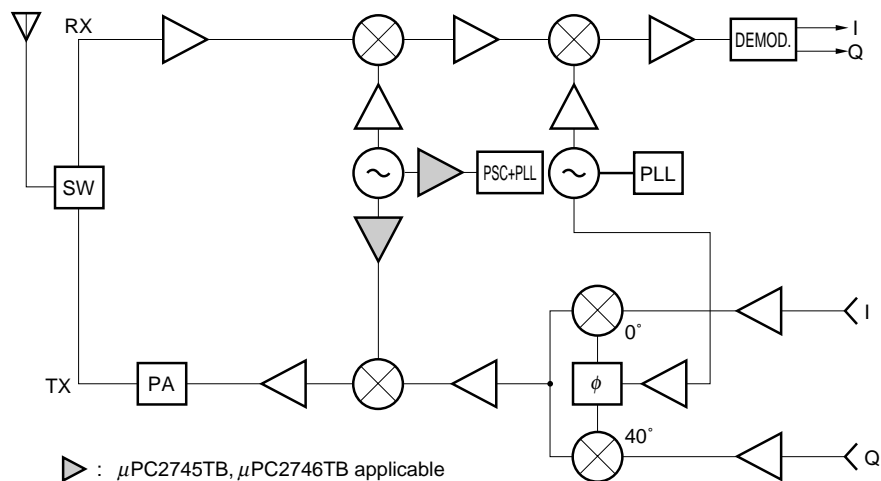

**PIN EXPLANATION**

Pin No.	Pin Name	Applied Voltage (V)	Pin Voltage (V) <small>Note</small>	Function and Applications	Internal Equivalent Circuit
1	INPUT	—	0.87 ----- 0.82	Signal input pin. A internal matching circuit, configured with resistors, enables 50 $\Omega$ connection over a wide band. this pin must be coupled to signal source with capacitor for DC cut.	
2 3 5	GND	0	—	Ground pin. This pin should be connected to system ground with minimum inductance. Ground pattern on the board should be formed as wide as possible. All the ground pins must be connected together with wide ground pattern to decrease impedance difference.	
4	OUTPUT	—	1.95 ----- 2.54	Signal output pin. A internal matching circuit, configured with resistors, enables 50 $\Omega$ connection over a wide band. This pin must be coupled to next stage with capacitor for DC cut.	
6	V <sub>CC</sub>	2.7 to 3.3	—	Power supply pin. This pin should be externally equipped with bypass capacity to minimize ground impedance.	

**Note** Pin voltage is measured at V<sub>CC</sub> = 3.0 V. Above:  $\mu$ PC2745TB, Below:  $\mu$ PC2746TB

**ABSOLUTE MAXIMUM RATINGS**

Parameter	Symbol	Conditions	Ratings	Unit
Supply Voltage	V <sub>CC</sub>	T <sub>A</sub> = +25°C	4.0	V
Circuit Current	I <sub>CC</sub>	T <sub>A</sub> = +25°C	16	mA
Power Dissipation	P <sub>D</sub>	T <sub>A</sub> = +85°C <b>Note</b>	270	mW
Operating Ambient Temperature	T <sub>A</sub>		-40 to +85	°C
Storage Temperature	T <sub>stg</sub>		-55 to +150	°C
Input Power	P <sub>in</sub>	T <sub>A</sub> = +25°C	0	dBm

**Note** Mounted on double-sided copper-clad 50 × 50 × 1.6 mm epoxy glass PWB

**RECOMMENDED OPERATING RANGE**

Parameter	Symbol	MIN.	TYP.	MAX.	Unit
Supply Voltage	V <sub>CC</sub>	2.7	3.0	3.3	V

**ELECTRICAL CHARACTERISTICS**

(T<sub>A</sub> = +25°C, V<sub>CC</sub> = 3.0 V, Z<sub>s</sub> = Z<sub>L</sub> = 50 Ω, unless otherwise specified)

Parameter	Symbol	Test Conditions	$\mu$ PC2745TB			$\mu$ PC2746TB			Unit
			MIN.	TYP.	MAX.	MIN.	TYP.	MAX.	
Circuit Current	I <sub>CC</sub>	No signal	5.0	7.5	10.0	5.0	7.5	10.0	mA
Power Gain	G <sub>P</sub>	f = 500 MHz	9	12	14	16	19	21	dB
Noise Figure	NF	f = 500 MHz	—	6.0	7.5	—	4.0	5.5	dB
Upper Limit Operating Frequency	f <sub>u</sub>	3 dB down below from gain at f = 0.1 GHz	2.3	2.7	—	1.1	1.5	—	GHz
Isolation	ISL	f = 500 MHz	33	38	—	40	45	—	dB
Input Return Loss	RL <sub>in</sub>	f = 500 MHz	8	11	—	10	13	—	dB
Output Return Loss	RL <sub>out</sub>	f = 500 MHz	2.5	5.5	—	5.5	8.5	—	dB
Saturated Output Power	P <sub>O(sat)</sub>	f = 500 MHz, P <sub>in</sub> = -6 dBm	-4.0	-1.0	—	-3.0	0	—	dBm

STANDARD CHARACTERISTICS FOR REFERENCE ( $T_A = +25^\circ\text{C}$ ,  $V_{CC} = 3.0\text{ V}$ ,  $Z_s = Z_L = 50\ \Omega$ )

Parameter	Symbol	Test Conditions	Reference Value		Unit
			$\mu$ PC2745TB	$\mu$ PC2746TB	
Circuit Current	$I_{CC}$	$V_{CC} = 1.8\text{ V}$ , No signal	4.5	4.5	mA
Power Gain	$G_P$	$V_{CC} = 3.0\text{ V}$ , $f = 1.0\text{ GHz}$	12.0	18.5	dB
		$V_{CC} = 3.0\text{ V}$ , $f = 2.0\text{ GHz}$	11.0	—	
		$V_{CC} = 1.8\text{ V}$ , $f = 0.5\text{ GHz}$	7.0	14.0	
Noise Figure	NF	$V_{CC} = 3.0\text{ V}$ , $f = 1.0\text{ GHz}$	5.5	4.2	dB
		$V_{CC} = 3.0\text{ V}$ , $f = 2.0\text{ GHz}$	5.7	—	
		$V_{CC} = 1.8\text{ V}$ , $f = 0.5\text{ GHz}$	8.0	5.0	
Upper Limit Operating Frequency	$f_u$	$V_{CC} = 1.8\text{ V}$ , 3 dB down below from gain at $f = 0.1\text{ GHz}$	1.8	1.1	GHz
Isolation	ISL	$V_{CC} = 3.0\text{ V}$ , $f = 1.0\text{ GHz}$	33	38	dB
		$V_{CC} = 3.0\text{ V}$ , $f = 2.0\text{ GHz}$	30	—	
		$V_{CC} = 1.8\text{ V}$ , $f = 0.5\text{ GHz}$	35	37	
Input Return Loss	$RL_{in}$	$V_{CC} = 3.0\text{ V}$ , $f = 1.0\text{ GHz}$	13.0	10.0	dB
		$V_{CC} = 3.0\text{ V}$ , $f = 2.0\text{ GHz}$	14.0	—	
		$V_{CC} = 1.8\text{ V}$ , $f = 0.5\text{ GHz}$	6.5	10.0	
Output Return Loss	$RL_{out}$	$V_{CC} = 3.0\text{ V}$ , $f = 1.0\text{ GHz}$	6.5	8.5	dB
		$V_{CC} = 3.0\text{ V}$ , $f = 2.0\text{ GHz}$	8.5	—	
		$V_{CC} = 1.8\text{ V}$ , $f = 0.5\text{ GHz}$	6.0	9.5	
Saturated Output Power	$P_{O(sat)}$	$V_{CC} = 3.0\text{ V}$ , $f = 1.0\text{ GHz}$ , $P_{in} = -6\text{ dBm}$	-2.5	-1.0	dBm
		$V_{CC} = 3.0\text{ V}$ , $f = 2.0\text{ GHz}$ , $P_{in} = -6\text{ dBm}$	-3.5	—	
		$V_{CC} = 1.8\text{ V}$ , $f = 0.5\text{ GHz}$ , $P_{in} = -10\text{ dBm}$	-11.0	-8.0	
★ 3rd Order Intermodulation Distortion	$IM_3$	$V_{CC} = 3.0\text{ V}$ , $P_{out} = -10\text{ dBm}$ , $f_1 = 500\text{ MHz}$ , $f_2 = 502\text{ MHz}$	-30.0	-26.0	dBc
		$V_{CC} = 1.8\text{ V}$ , $P_{out} = -20\text{ dBm}$ , $f_1 = 500\text{ MHz}$ , $f_2 = 502\text{ MHz}$	-31.0	-37.0	
		$V_{CC} = 3.0\text{ V}$ , $P_{out} = -10\text{ dBm}$ , $f_1 = 1\ 000\text{ MHz}$ , $f_2 = 1\ 002\text{ MHz}$	-26.0	—	

**TEST CIRCUIT**

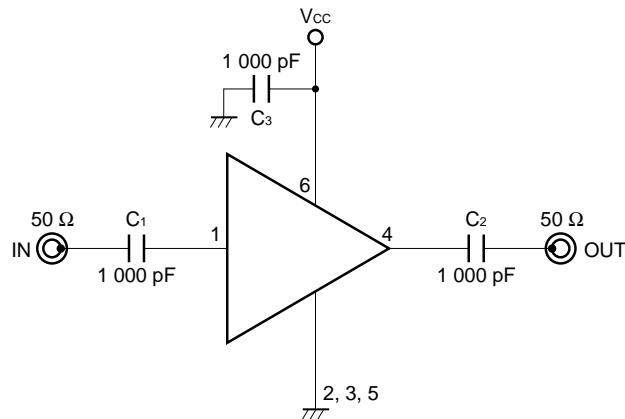

**EXAMPLE OF APPLICATION CIRCUIT**

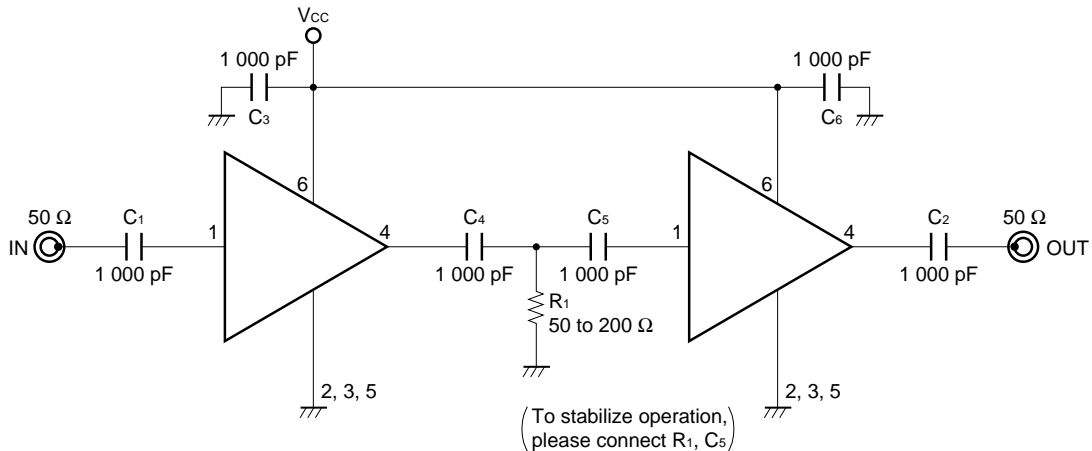

The application circuits and their parameters are for references only and are not intended for use in actual design-ins.

**CAPACITORS FOR THE V<sub>CC</sub>, INPUT, AND OUTPUT PINS**

Capacitors of 1 000 pF are recommendable as the bypass capacitor for the V<sub>CC</sub> pin and the coupling capacitors for the input and output pins.

The bypass capacitor connected to the V<sub>CC</sub> pin is used to minimize ground impedance of V<sub>CC</sub> pin. So, stable bias can be supplied against V<sub>CC</sub> fluctuation.

The coupling capacitors, connected to the input and output pins, are used to cut the DC and minimize RF serial impedance. Their capacitance are therefore selected as lower impedance against a 50 Ω load. The capacitors thus perform as high pass filters, suppressing low frequencies to DC.

To obtain a flat gain from 100 MHz upwards, 1 000 pF capacitors are used in the test circuit. In the case of under 10 MHz operation, increase the value of coupling capacitor such as 10 000 pF. Because the coupling capacitors are determined by equation,  $f_c = 1/(2\pi RC)$ .

ILLUSTRATION OF THE TEST CIRCUIT ASSEMBLED ON EVALUATION BOARD

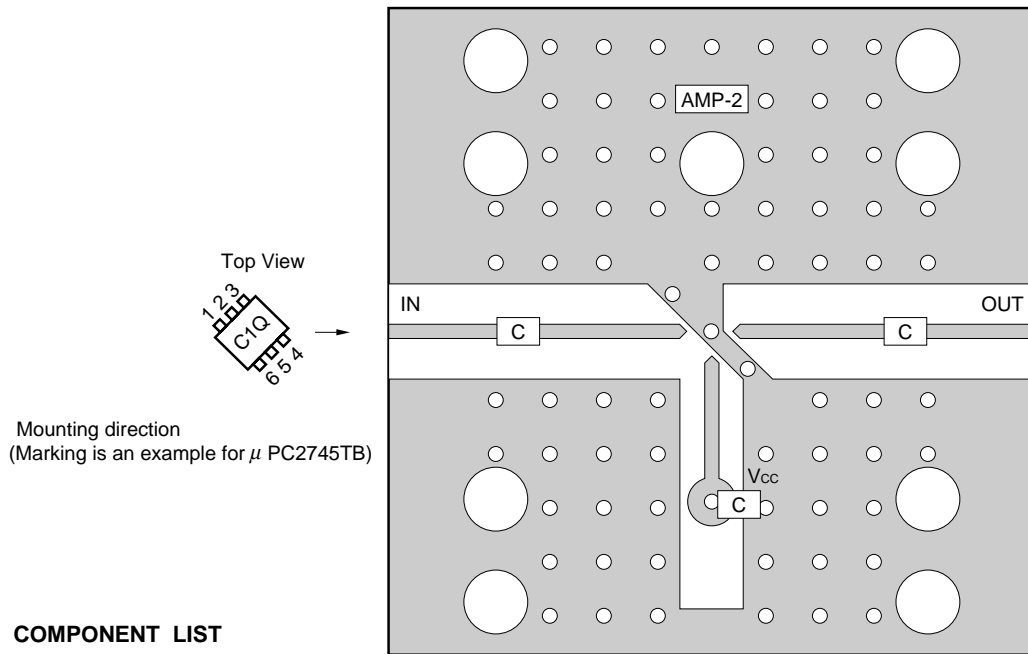

Mounting direction  
(Marking is an example for  $\mu$  PC2745TB)

COMPONENT LIST

	Value
C	1 000 pF

Notes

1. 30 × 30 × 0.4 mm double sided copper clad polyimide board.
2. Back side: GND pattern
3. Solder plated on pattern
4.  $\oplus \oplus \oplus$ : Through holes

For more information on the use of this IC, refer to the following application note: **USAGE AND APPLICATIONS OF 6-PIN MINI-MOLD, 6-PIN SUPER MINI-MOLD SILICON HIGH-FREQUENCY WIDEBAND AMPLIFIER MMIC (P11976E).**

**TYPICAL CHARACTERISTICS ( $T_A = +25^\circ\text{C}$ , unless otherwise specified)**

—  $\mu$ PC2745TB —

**CIRCUIT CURRENT vs. SUPPLY VOLTAGE**

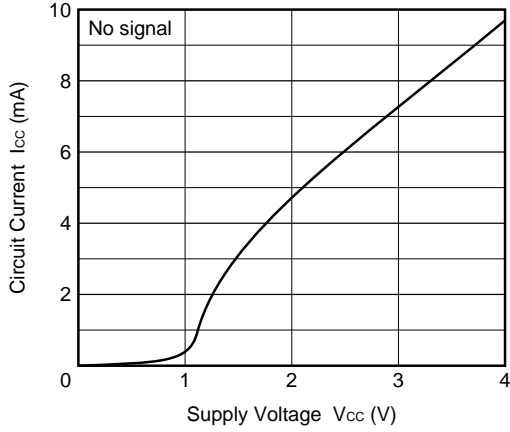

**CIRCUIT CURRENT vs. OPERATING AMBIENT TEMPERATURE**

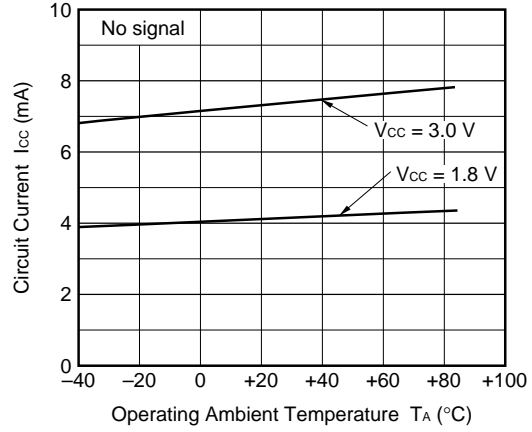

**NOISE FIGURE, POWER GAIN vs. FREQUENCY**

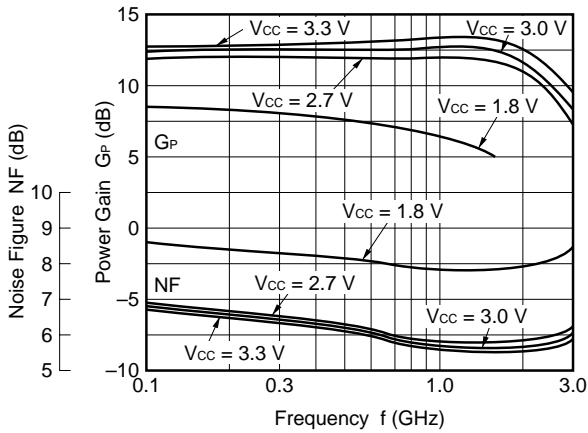

**POWER GAIN vs. FREQUENCY**

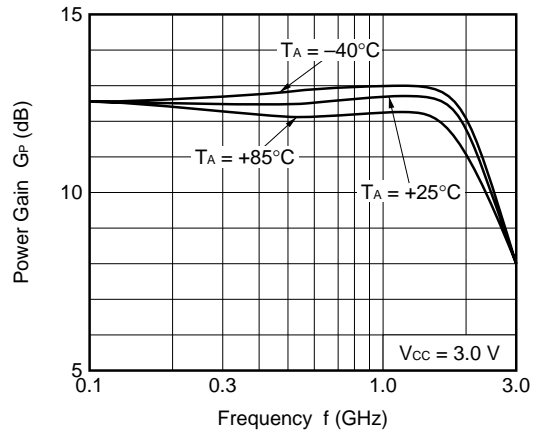

**ISOLATION vs. FREQUENCY**

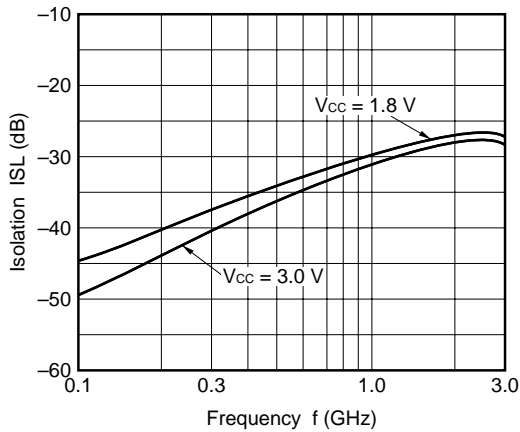

**INPUT RETURN LOSS, OUTPUT RETURN LOSS vs. FREQUENCY**

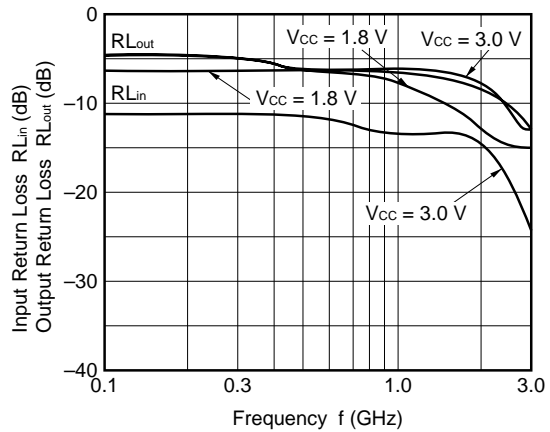

**Remark** The graphs indicate nominal characteristics.



—  $\mu$ PC2745TB —

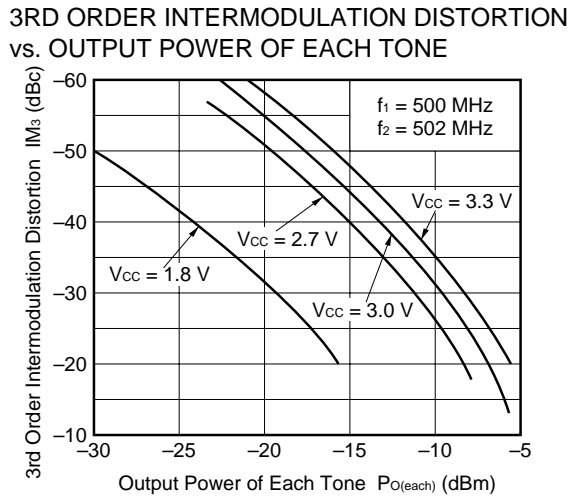
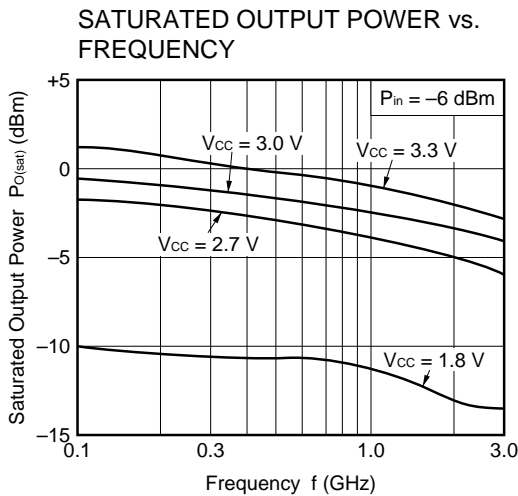
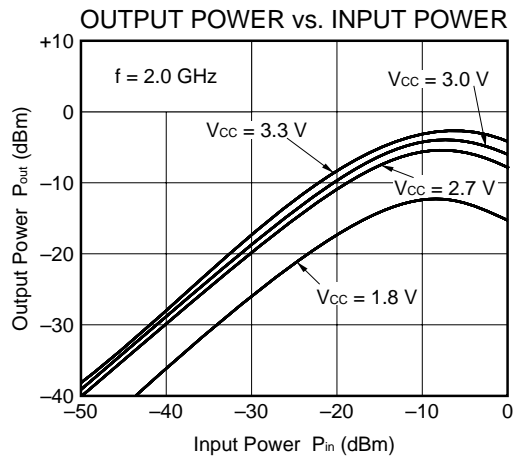
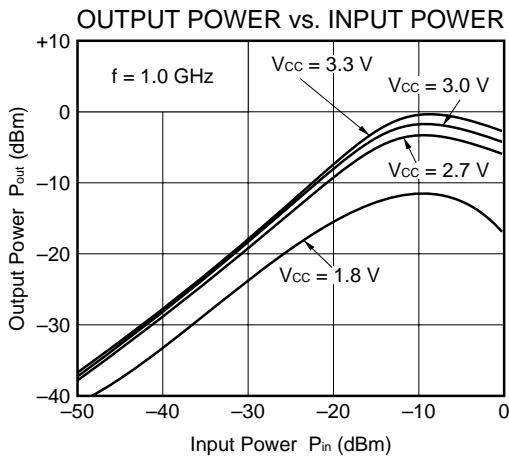
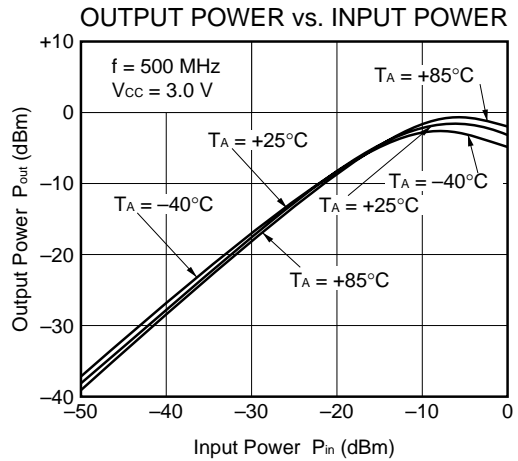
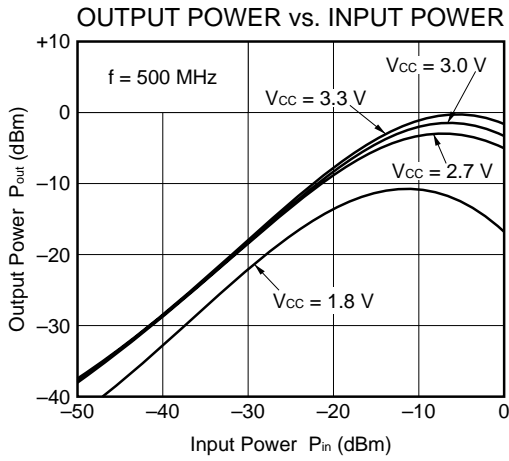

**Remark** The graphs indicate nominal characteristics.

SMITH CHART ( $T_A = +25^\circ\text{C}$ ,  $V_{CC} = 3.0\text{ V}$ )

—  $\mu$ PC2745TB —

S<sub>11</sub>-FREQUENCY

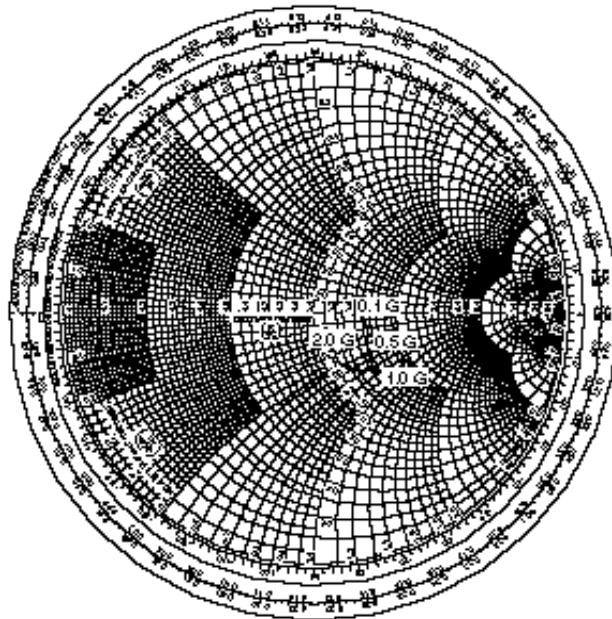

S<sub>22</sub>-FREQUENCY

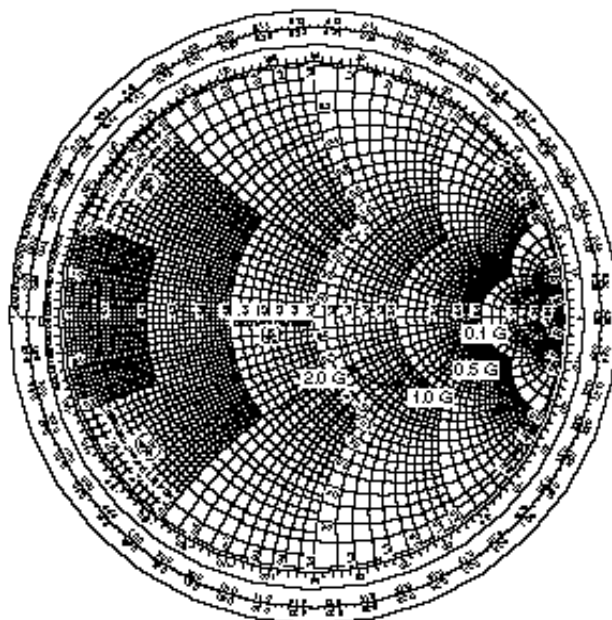

**S-PARAMETERS**

S-parameters/Noise parameters are provided on the NEC Compound Semiconductor Devices Web site in a form (S2P) that enables direct import to a microwave circuit simulator without keyboard input.

Click here to download S-parameters.

[RF and Microwave] → [Device Parameters]

URL <http://www.ncsd.necel.com/>

TYPICAL CHARACTERISTICS (T<sub>A</sub> = +25°C, unless otherwise specified)

—  $\mu$ PC2746TB —

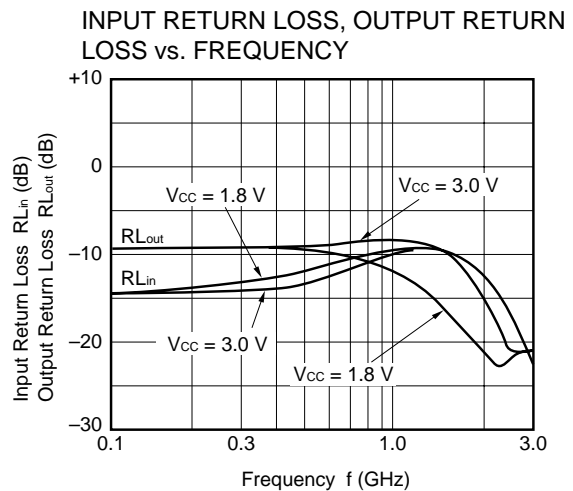
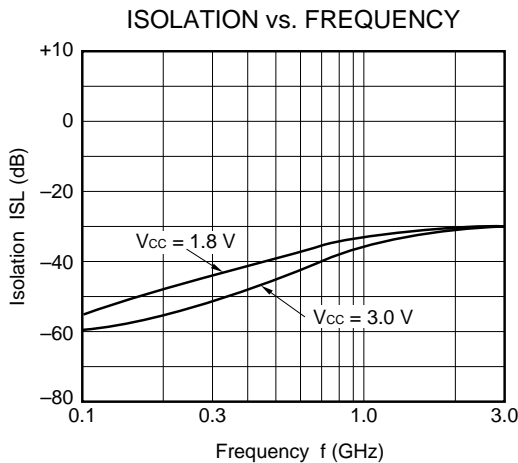
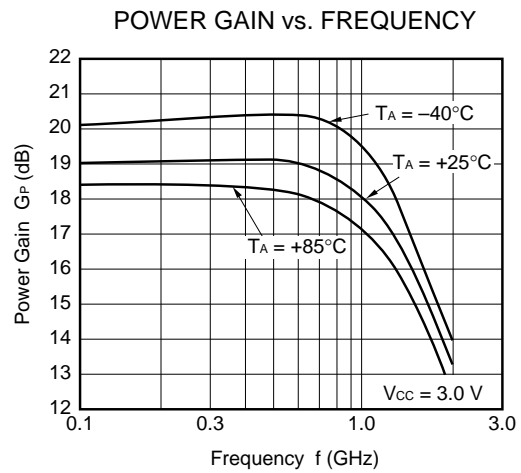
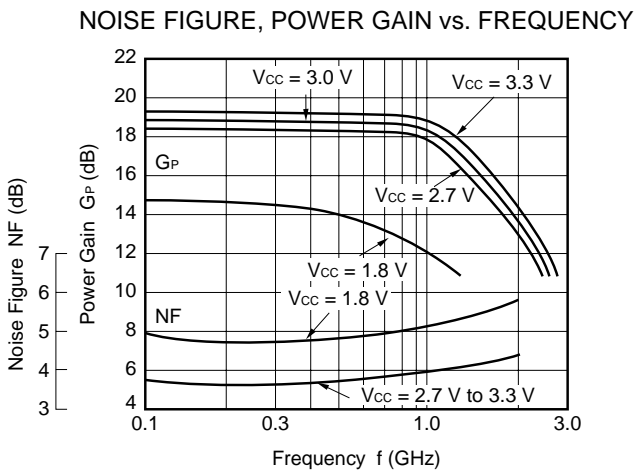
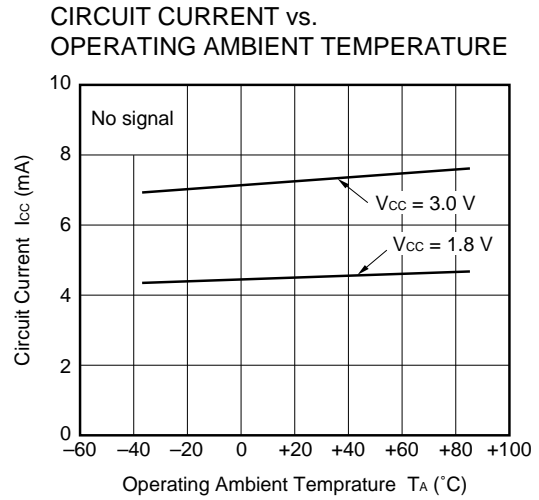
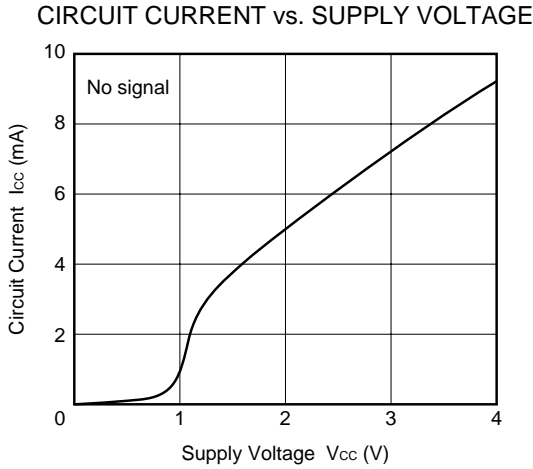

Remark The graphs indicate nominal characteristics.

—  $\mu$ PC2746TB —

OUTPUT POWER vs. INPUT POWER

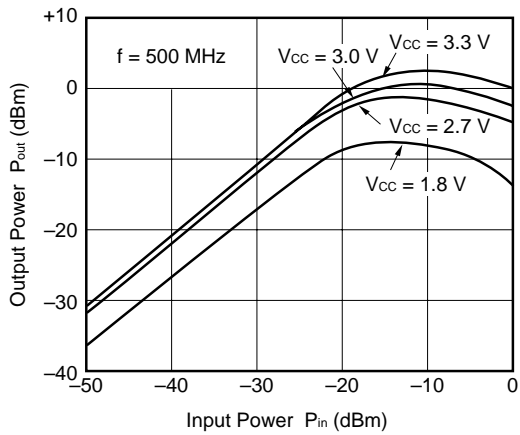

OUTPUT POWER vs. INPUT POWER

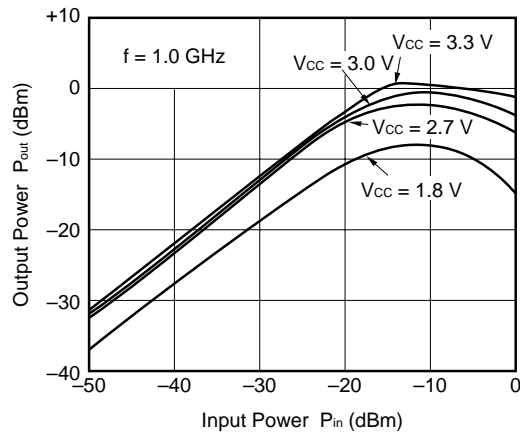

OUTPUT POWER vs. INPUT POWER

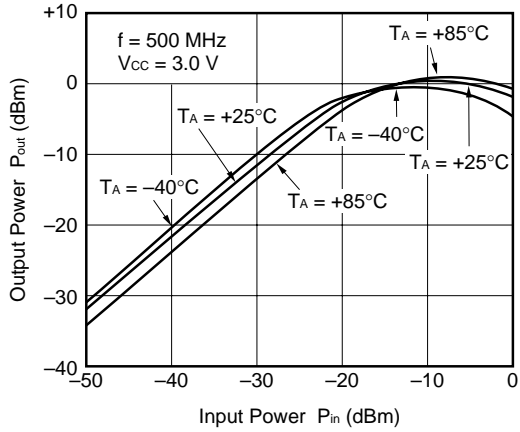

OUTPUT POWER vs. INPUT POWER

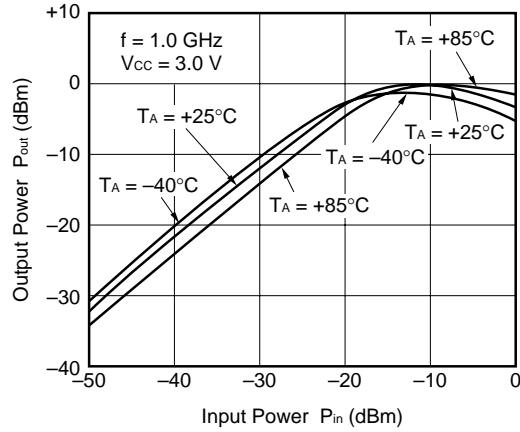

SATURATED OUTPUT POWER vs. FREQUENCY

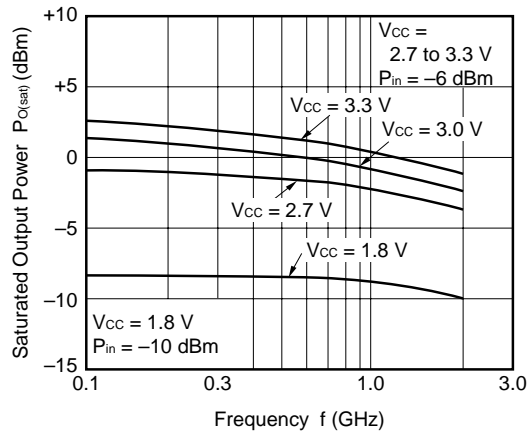

3RD ORDER INTERMODULATION DISTORTION vs. OUTPUT POWER OF EACH TONE

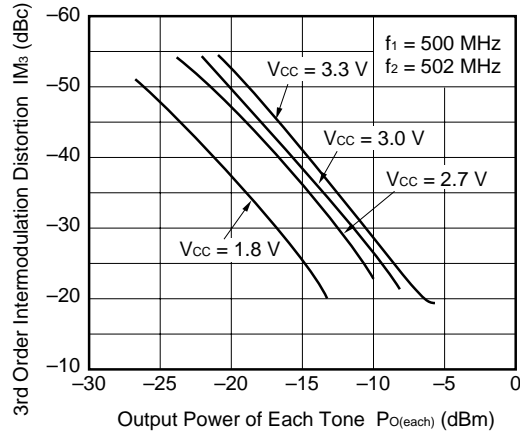

**Remark** The graphs indicate nominal characteristics.

SMITH CHART ( $T_A = +25^\circ\text{C}$ ,  $V_{CC} = 3.0\text{ V}$ )

—  $\mu$ PC2746TB —

$S_{11}$ -FREQUENCY

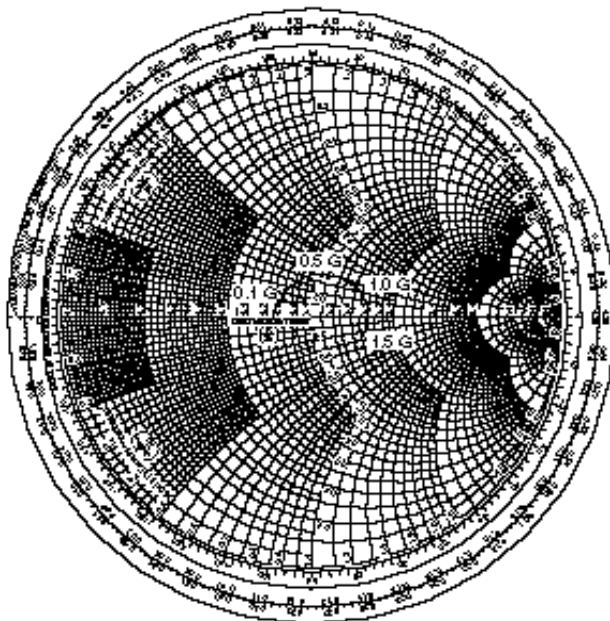

$S_{22}$ -FREQUENCY

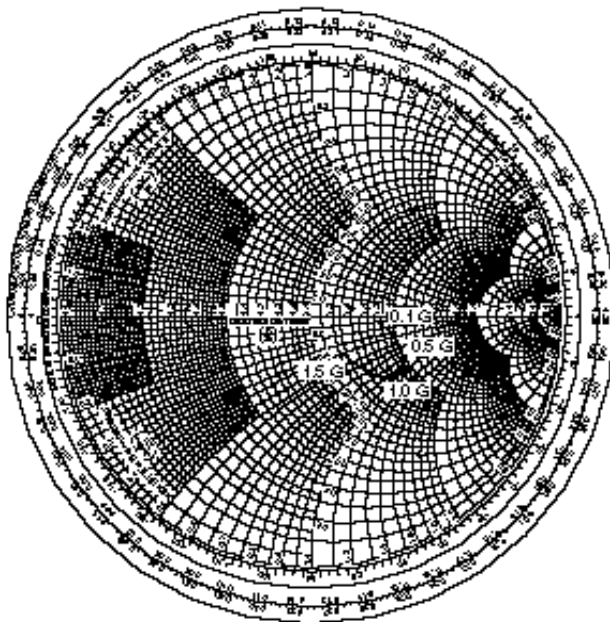

**S-PARAMETERS**

S-parameters/Noise parameters are provided on the NEC Compound Semiconductor Devices Web site in a form (S2P) that enables direct import to a microwave circuit simulator without keyboard input.

Click here to download S-parameters.

[RF and Microwave] → [Device Parameters]

URL <http://www.ncsd.necel.com/>

PACKAGE DIMENSIONS

6-PIN SUPER MINIMOLD (UNIT: mm)

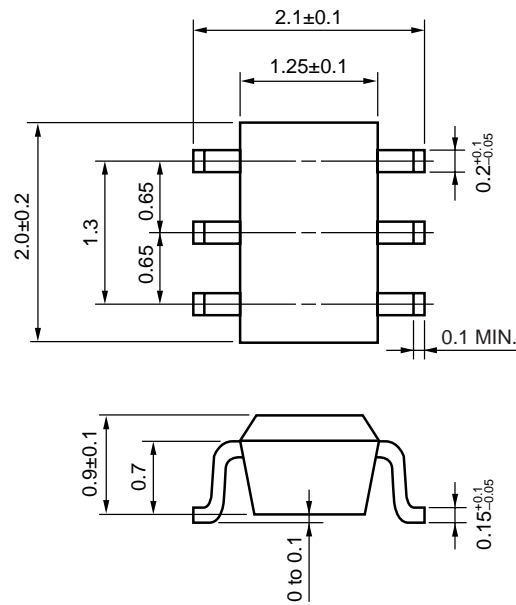



**NOTES ON CORRECT USE**

- (1) Observe precautions for handling because of electro-static sensitive devices.
- (2) Form a ground pattern as widely as possible to minimize ground impedance (to prevent undesired oscillation).  
All the ground pins must be connected together with wide ground pattern to decrease impedance difference.
- (3) The bypass capacitor should be attached to the V<sub>CC</sub> pin.
- (4) The DC cut capacitor must be attached to input pin and output pin.

**RECOMMENDED SOLDERING CONDITIONS**

This product should be soldered and mounted under the following recommended conditions. For soldering methods and conditions other than those recommended below, contact your nearby sales office.

Soldering Method	Soldering Conditions	Condition Symbol
Infrared Reflow	Peak temperature (package surface temperature) : 260°C or below Time at peak temperature : 10 seconds or less Time at temperature of 220°C or higher : 60 seconds or less Preheating time at 120 to 180°C : 120±30 seconds Maximum number of reflow processes : 3 times Maximum chlorine content of rosin flux (% mass) : 0.2%(Wt.) or below	IR260
VPS	Peak temperature (package surface temperature) : 215°C or below Time at temperature of 200°C or higher : 25 to 40 seconds Preheating time at 120 to 150°C : 30 to 60 seconds Maximum number of reflow processes : 3 times Maximum chlorine content of rosin flux (% mass) : 0.2%(Wt.) or below	VP215
Wave Soldering	Peak temperature (molten solder temperature) : 260°C or below Time at peak temperature : 10 seconds or less Preheating temperature (package surface temperature) : 120°C or below Maximum number of flow processes : 1 time Maximum chlorine content of rosin flux (% mass) : 0.2%(Wt.) or below	WS260
Partial Heating	Peak temperature (pin temperature) : 350°C or below Soldering time (per side of device) : 3 seconds or less Maximum chlorine content of rosin flux (% mass) : 0.2%(Wt.) or below	HS350

**Caution Do not use different soldering methods together (except for partial heating).**

- **The information in this document is current as of November, 2003. The information is subject to change without notice. For actual design-in, refer to the latest publications of NEC's data sheets or data books, etc., for the most up-to-date specifications of NEC semiconductor products. Not all products and/or types are available in every country. Please check with an NEC sales representative for availability and additional information.**
  - No part of this document may be copied or reproduced in any form or by any means without prior written consent of NEC. NEC assumes no responsibility for any errors that may appear in this document.
  - NEC does not assume any liability for infringement of patents, copyrights or other intellectual property rights of third parties by or arising from the use of NEC semiconductor products listed in this document or any other liability arising from the use of such products. No license, express, implied or otherwise, is granted under any patents, copyrights or other intellectual property rights of NEC or others.
  - Descriptions of circuits, software and other related information in this document are provided for illustrative purposes in semiconductor product operation and application examples. The incorporation of these circuits, software and information in the design of customer's equipment shall be done under the full responsibility of customer. NEC assumes no responsibility for any losses incurred by customers or third parties arising from the use of these circuits, software and information.
  - While NEC endeavours to enhance the quality, reliability and safety of NEC semiconductor products, customers agree and acknowledge that the possibility of defects thereof cannot be eliminated entirely. To minimize risks of damage to property or injury (including death) to persons arising from defects in NEC semiconductor products, customers must incorporate sufficient safety measures in their design, such as redundancy, fire-containment, and anti-failure features.
  - NEC semiconductor products are classified into the following three quality grades:  
"Standard", "Special" and "Specific". The "Specific" quality grade applies only to semiconductor products developed based on a customer-designated "quality assurance program" for a specific application. The recommended applications of a semiconductor product depend on its quality grade, as indicated below. Customers must check the quality grade of each semiconductor product before using it in a particular application.
    - "Standard": Computers, office equipment, communications equipment, test and measurement equipment, audio and visual equipment, home electronic appliances, machine tools, personal electronic equipment and industrial robots
    - "Special": Transportation equipment (automobiles, trains, ships, etc.), traffic control systems, anti-disaster systems, anti-crime systems, safety equipment and medical equipment (not specifically designed for life support)
    - "Specific": Aircraft, aerospace equipment, submersible repeaters, nuclear reactor control systems, life support systems and medical equipment for life support, etc.
- The quality grade of NEC semiconductor products is "Standard" unless otherwise expressly specified in NEC's data sheets or data books, etc. If customers wish to use NEC semiconductor products in applications not intended by NEC, they must contact an NEC sales representative in advance to determine NEC's willingness to support a given application.
- (Note)
- (1) "NEC" as used in this statement means NEC Corporation, NEC Compound Semiconductor Devices, Ltd. and also includes its majority-owned subsidiaries.
  - (2) "NEC semiconductor products" means any semiconductor product developed or manufactured by or for NEC (as defined above).

M8E 00.4-0110

► **For further information, please contact**

**NEC Compound Semiconductor Devices, Ltd.** <http://www.ncsd.necel.com/>

E-mail: [salesinfo@ml.ncsd.necel.com](mailto:salesinfo@ml.ncsd.necel.com) (sales and general)

[techinfo@ml.ncsd.necel.com](mailto:techinfo@ml.ncsd.necel.com) (technical)

5th Sales Group, Sales Division TEL: +81-44-435-1588 FAX: +81-44-435-1579

**NEC Compound Semiconductor Devices Hong Kong Limited**

E-mail: [ncsd-hk@elhk.nec.com.hk](mailto:ncsd-hk@elhk.nec.com.hk) (sales, technical and general)

Hong Kong Head Office TEL: +852-3107-7303 FAX: +852-3107-7309

Taipei Branch Office TEL: +886-2-8712-0478 FAX: +886-2-2545-3859

Korea Branch Office TEL: +82-2-558-2120 FAX: +82-2-558-5209

**NEC Electronics (Europe) GmbH** <http://www.ee.nec.de/>

TEL: +49-211-6503-01 FAX: +49-211-6503-487

**California Eastern Laboratories, Inc.** <http://www.cel.com/>

TEL: +1-408-988-3500 FAX: +1-408-988-0279

0310

Subject: Compliance with EU Directives

CEL certifies, to its knowledge, that semiconductor and laser products detailed below are compliant with the requirements of European Union (EU) Directive 2002/95/EC Restriction on Use of Hazardous Substances in electrical and electronic equipment (RoHS) and the requirements of EU Directive 2003/11/EC Restriction on Penta and Octa BDE.

CEL Pb-free products have the same base part number with a suffix added. The suffix –A indicates that the device is Pb-free. The –AZ suffix is used to designate devices containing Pb which are exempted from the requirement of RoHS directive (\*). In all cases the devices have Pb-free terminals. All devices with these suffixes meet the requirements of the RoHS directive.

This status is based on CEL’s understanding of the EU Directives and knowledge of the materials that go into its products as of the date of disclosure of this information.

Restricted Substance per RoHS	Concentration Limit per RoHS (values are not yet fixed)	Concentration contained in CEL devices	
		-A	-AZ
Lead (Pb)	< 1000 PPM	Not Detected	(*)
Mercury	< 1000 PPM	Not Detected	
Cadmium	< 100 PPM	Not Detected	
Hexavalent Chromium	< 1000 PPM	Not Detected	
PBB	< 1000 PPM	Not Detected	
PBDE	< 1000 PPM	Not Detected	

If you should have any additional questions regarding our devices and compliance to environmental standards, please do not hesitate to contact your local representative.

**Important Information and Disclaimer:** Information provided by CEL on its website or in other communications concerning the substance content of its products represents knowledge and belief as of the date that it is provided. CEL bases its knowledge and belief on information provided by third parties and makes no representation or warranty as to the accuracy of such information. Efforts are underway to better integrate information from third parties. CEL has taken and continues to take reasonable steps to provide representative and accurate information but may not have conducted destructive testing or chemical analysis on incoming materials and chemicals. CEL and CEL suppliers consider certain information to be proprietary, and thus CAS numbers and other limited information may not be available for release.

In no event shall CEL’s liability arising out of such information exceed the total purchase price of the CEL part(s) at issue sold by CEL to customer on an annual basis.

See CEL Terms and Conditions for additional clarification of warranties and liability.