

## LP2985

# Micropower 150 mA Low-Noise Ultra Low-Dropout Regulator in SOT-23 and micro SMD Packages

## *Designed for Use with Very Low ESR Output Capacitors*

### General Description

The LP2985 is a 150 mA, fixed-output voltage regulator designed to provide ultra low-dropout and low noise in battery powered applications.

Using an optimized VIP® (Vertically Integrated PNP) process, the LP2985 delivers unequalled performance in all specifications critical to battery-powered designs:

**Dropout Voltage:** Typically 300 mV @ 150 mA load, and 7 mV @ 1 mA load.

**Ground Pin Current:** Typically 850  $\mu$ A @ 150 mA load, and 75  $\mu$ A @ 1 mA load.

**Enhanced Stability:** The LP2985 is stable with output capacitor ESR as low as 5 m $\Omega$ , which allows the use of ceramic capacitors on the output.

**Sleep Mode:** Less than 1  $\mu$ A quiescent current when ON/OFF pin is pulled low.

**Smallest Possible Size:** SOT-23 and micro SMD packages use absolute minimum board space.

**Precision Output:** 1% tolerance output voltages available (A grade).

**Low Noise:** By adding a 10 nF bypass capacitor, output noise can be reduced to 30  $\mu$ V (typical).

Multiple voltage options, from 2.5V to 5.0V, are available as standard products. Consult factory for custom voltages.

### Features

- Ultra low dropout voltage
- Guaranteed 150 mA output current
- Smallest possible size (SOT-23, micro SMD package)
- Requires minimum external components
- Stable with low-ESR output capacitor
- <1  $\mu$ A quiescent current when shut down
- Low ground pin current at all loads
- Output voltage accuracy 1% (A Grade)
- High peak current capability
- Wide supply voltage range (16V max)
- Low  $Z_{OUT}$ : 0.3 $\Omega$  typical (10 Hz to 1 MHz)
- Overtemperature/overcurrent protection
- -40°C to +125°C junction temperature range
- Custom voltages available

### Applications

- Cellular Phone
- Palmtop/Laptop Computer
- Personal Digital Assistant (PDA)
- Camcorder, Personal Stereo, Camera

### Block Diagram

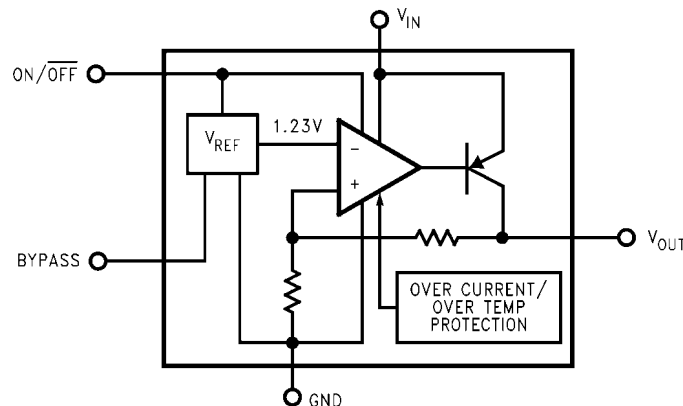

10014001

## Basic Application Circuit

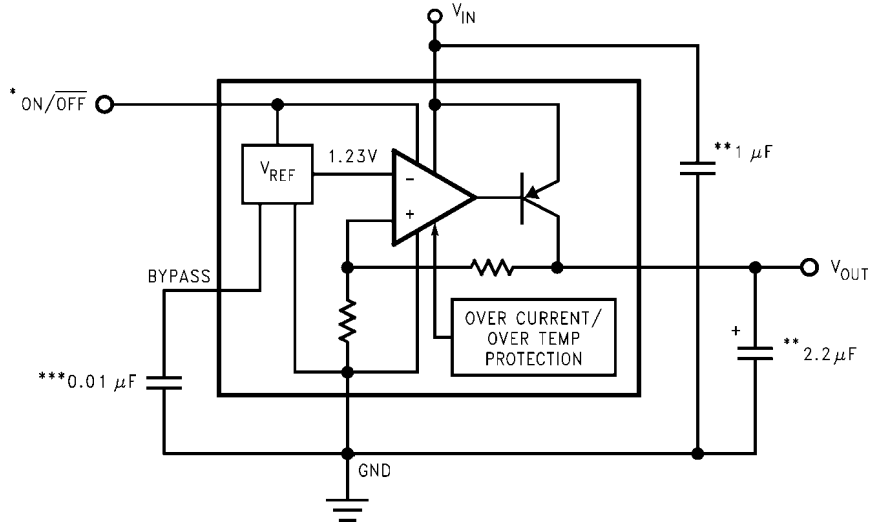

10014002

\*ON/OFF input must be actively terminated. Tie to  $V_{IN}$  if this function is not to be used.

\*\*Minimum capacitance is shown to ensure stability (may be increased without limit). Ceramic capacitor required for output (see Application Hints).

\*\*\*Reduces output noise (may be omitted if application is not noise critical). Use ceramic or film type with very low leakage current (see Application Hints).

## Connection Diagrams

5-Lead Small Outline Package (M5)

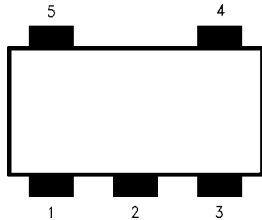

10014003

Top View  
See NS Package Number MF05A  
For ordering information see Table 1

micro SMD, 5 Bump Package (BPA05, TPA05 & BLA05, & TLA05)

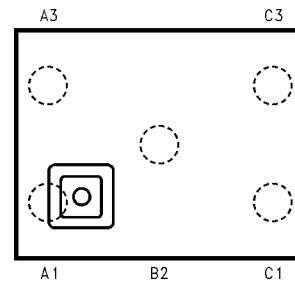

10014046

Note: The actual physical placement of the package marking will vary from part to part. Package marking contains date code and lot traceability information, and will vary considerably. Package marking does not correlate to device type.

Top View  
See NS Package Number BPA05, TPA05, BLA05 & TLA05

## Pin Descriptions

| Name      | Pin Number |           | Function                                 |
|-----------|------------|-----------|--|
|           | SOT-23     | micro SMD |  |
| $V_{IN}$  | 1          | C3        | Input Voltage                            |
| GND       | 2          | A1        | Common Ground (device substrate)         |
| ON/OFF    | 3          | A3        | Logic high enable input                  |
| BYPASS    | 4          | B2        | Bypass capacitor for low noise operation |
| $V_{OUT}$ | 5          | C1        | Regulated output voltage                 |

## Ordering Information

TABLE 1. Package Marking and Ordering Information

| Output Voltage (V)  | Grade | Order Information | Package Marking | Supplied as:                |
|---|-------|-------------------|-----------------|-----------------------------|
| <b>5-Lead Small Outline Package (M5)</b>  |       |                   |                 |                             |
| <b>For output voltages <math>\leq 2.3V</math>, refer to LP2985LV datasheet.</b> |       |                   |                 |                             |
| 2.5   | A     | LP2985AIM5X-2.5   | LAUA            | 3000 Units on Tape and Reel |
| 2.5   | A     | LP2985AIM5-2.5    | LAUA            | 1000 Units on Tape and Reel |
| 2.5   | STD   | LP2985IM5X-2.5    | LAUB            | 3000 Units on Tape and Reel |
| 2.5   | STD   | LP2985IM5-2.5     | LAUB            | 1000 Units on Tape and Reel |
| 2.6   | A     | LP2985AIM5X-2.6   | LCEA            | 3000 Units on Tape and Reel |
| 2.6   | A     | LP2985AIM5-2.6    | LCEA            | 1000 Units on Tape and Reel |
| 2.6   | STD   | LP2985IM5X-2.6    | LCEB            | 3000 Units on Tape and Reel |
| 2.6   | STD   | LP2985IM5-2.6     | LCEB            | 1000 Units on Tape and Reel |
| 2.7   | A     | LP2985AIM5X-2.7   | LALA            | 3000 Units on Tape and Reel |
| 2.7   | A     | LP2985AIM5-2.7    | LALA            | 1000 Units on Tape and Reel |
| 2.7   | STD   | LP2985IM5X-2.7    | LALB            | 3000 Units on Tape and Reel |
| 2.7   | STD   | LP2985IM5-2.7     | LALB            | 1000 Units on Tape and Reel |
| 2.8   | A     | LP2985AIM5X-2.8   | L0KA            | 3000 Units on Tape and Reel |
| 2.8   | A     | LP2985AIM5-2.8    | L0KA            | 1000 Units on Tape and Reel |
| 2.8   | STD   | LP2985IM5X-2.8    | L0KB            | 3000 Units on Tape and Reel |
| 2.8   | STD   | LP2985IM5-2.8     | L0KB            | 1000 Units on Tape and Reel |
| 2.9   | A     | LP2985AIM5X-2.9   | LAXA            | 3000 Units on Tape and Reel |
| 2.9   | A     | LP2985AIM5-2.9    | LAXA            | 1000 Units on Tape and Reel |
| 2.9   | STD   | LP2985IM5X-2.9    | LAXB            | 3000 Units on Tape and Reel |
| 2.9   | STD   | LP2985IM5-2.9     | LAXB            | 1000 Units on Tape and Reel |
| 3.0   | A     | LP2985AIM5X-3.0   | L0OA            | 3000 Units on Tape and Reel |
| 3.0   | A     | LP2985AIM5-3.0    | L0OA            | 1000 Units on Tape and Reel |
| 3.0   | STD   | LP2985IM5X-3.0    | L0OB            | 3000 Units on Tape and Reel |
| 3.0   | STD   | LP2985IM5-3.0     | L0OB            | 1000 Units on Tape and Reel |
| 3.1   | A     | LP2985AIM5X-3.1   | L0PA            | 3000 Units on Tape and Reel |
| 3.1   | A     | LP2985AIM5-3.1    | L0PA            | 1000 Units on Tape and Reel |
| 3.1   | STD   | LP2985IM5X-3.1    | L0PB            | 3000 Units on Tape and Reel |
| 3.1   | STD   | LP2985IM5-3.1     | L0PB            | 1000 Units on Tape and Reel |
| 3.2   | A     | LP2985AIM5X-3.2   | L0QA            | 3000 Units on Tape and Reel |
| 3.2   | A     | LP2985AIM5-3.2    | L0QA            | 1000 Units on Tape and Reel |
| 3.2   | STD   | LP2985IM5X-3.2    | L0QB            | 3000 Units on Tape and Reel |
| 3.2   | STD   | LP2985IM5-3.2     | L0QB            | 1000 Units on Tape and Reel |
| 3.3   | A     | LP2985AIM5X-3.3   | L0RA            | 3000 Units on Tape and Reel |
| 3.3   | A     | LP2985AIM5-3.3    | L0RA            | 1000 Units on Tape and Reel |
| 3.3   | STD   | LP2985IM5X-3.3    | L0RB            | 3000 Units on Tape and Reel |
| 3.3   | STD   | LP2985IM5-3.3     | L0RB            | 1000 Units on Tape and Reel |
| 3.5   | A     | LP2985AIM5X-3.5   | LAIA            | 3000 Units on Tape and Reel |
| 3.5   | A     | LP2985AIM5-3.5    | LAIA            | 1000 Units on Tape and Reel |
| 3.5   | STD   | LP2985IM5X-3.5    | LAIB            | 3000 Units on Tape and Reel |
| 3.5   | STD   | LP2985IM5-3.5     | LAIB            | 1000 Units on Tape and Reel |
| 3.6   | A     | LP2985AIM5X-3.6   | L0SA            | 3000 Units on Tape and Reel |
| 3.6   | A     | LP2985AIM5-3.6    | L0SA            | 1000 Units on Tape and Reel |
| 3.6   | STD   | LP2985IM5X-3.6    | L0SB            | 3000 Units on Tape and Reel |
| 3.6   | STD   | LP2985IM5-3.6     | L0SB            | 1000 Units on Tape and Reel |

| Output Voltage (V)                                     | Grade | Order Information | Package Marking | Supplied as:                |
|--|-------|-------------------|-----------------|-----------------------------|
| 3.8  | A     | LP2985AIM5X-3.8   | L0YA            | 3000 Units on Tape and Reel |
| 3.8  | A     | LP2985AIM5-3.8    | L0YA            | 1000 Units on Tape and Reel |
| 3.8  | STD   | LP2985IM5X-3.8    | L0YB            | 3000 Units on Tape and Reel |
| 3.8  | STD   | LP2985IM5-3.8     | L0YB            | 1000 Units on Tape and Reel |
| 4.0  | A     | LP2985AIM5X-4.0   | L0TA            | 3000 Units on Tape and Reel |
| 4.0  | A     | LP2985AIM5-4.0    | L0TA            | 1000 Units on Tape and Reel |
| 4.0  | STD   | LP2985IM5X-4.0    | L0TB            | 3000 Units on Tape and Reel |
| 4.0  | STD   | LP2985IM5-4.0     | L0TB            | 1000 Units on Tape and Reel |
| 4.5  | A     | LP2985AIM5X-4.5   | LA7A            | 3000 Units on Tape and Reel |
| 4.5  | A     | LP2985AIM5-4.5    | LA7A            | 1000 Units on Tape and Reel |
| 4.5  | STD   | LP2985IM5X-4.5    | LA7B            | 3000 Units on Tape and Reel |
| 4.5  | STD   | LP2985IM5-4.5     | LA7B            | 1000 Units on Tape and Reel |
| 4.7  | A     | LP2985AIM5X-4.7   | LAJA            | 3000 Units on Tape and Reel |
| 4.7  | A     | LP2985AIM5-4.7    | LAJA            | 1000 Units on Tape and Reel |
| 4.7  | STD   | LP2985IM5X-4.7    | LAJB            | 3000 Units on Tape and Reel |
| 4.7  | STD   | LP2985IM5-4.7     | LAJB            | 1000 Units on Tape and Reel |
| 4.8  | A     | LP2985AIM5X-4.8   | LAKA            | 3000 Units on Tape and Reel |
| 4.8  | A     | LP2985AIM5-4.8    | LAKA            | 1000 Units on Tape and Reel |
| 4.8  | STD   | LP2985IM5X-4.8    | LAKB            | 3000 Units on Tape and Reel |
| 4.8  | STD   | LP2985IM5-4.8     | LAKB            | 1000 Units on Tape and Reel |
| 5.0  | A     | LP2985AIM5X-5.0   | L0UA            | 3000 Units on Tape and Reel |
| 5.0  | A     | LP2985AIM5-5.0    | L0UA            | 1000 Units on Tape and Reel |
| 5.0  | STD   | LP2985IM5X-5.0    | L0UB            | 3000 Units on Tape and Reel |
| 5.0  | STD   | LP2985IM5-5.0     | L0UB            | 1000 Units on Tape and Reel |
| 5.3  | A     | LP2985AIM5X-5.3   | LFYA            | 3000 Units on Tape and Reel |
| 5.3  | A     | LP2985AIM5-5.3    | LFYA            | 1000 Units on Tape and Reel |
| 5.3  | STD   | LP2985IM5X-5.3    | LFYB            | 3000 Units on Tape and Reel |
| 5.3  | STD   | LP2985IM5-5.3     | LFYB            | 1000 Units on Tape and Reel |
| 6.1  | A     | LP2985AIM5X-6.1   | LF6A            | 3000 Units on Tape and Reel |
| 6.1  | A     | LP2985AIM5-6.1    | LF6A            | 1000 Units on Tape and Reel |
| 6.1  | STD   | LP2985IM5X-6.1    | LF6B            | 3000 Units on Tape and Reel |
| 6.1  | STD   | LP2985IM5-6.1     | LF6B            | 1000 Units on Tape and Reel |
| 12<br>(Note 11)  | A     | LP2985AIM5X-12    | LH1A            | 3000 Units on Tape and Reel |
| 12<br>(Note 11)  | A     | LP2985AIM5-12     | LH1A            | 1000 Units on Tape and Reel |
| 12<br>(Note 11)  | STD   | LP2985IM5X-12     | LH1B            | 3000 Units on Tape and Reel |
| 12<br>(Note 11)  | STD   | LP2985IM5-12      | LH1B            | 1000 Units on Tape and Reel |
| <b>micro SMD, 5 Bump Package (BPA05 - 170 µm ball)</b> |       |                   |                 |                             |
| 2.4  | A     | LP2985AIBP-2.4    |                 | 250 Units on Tape and Reel  |
| 2.4  | A     | LP2985AIBPX-2.4   |                 | 3000 Units on Tape and Reel |
| 2.4  | STD   | LP2985IBP-2.4     |                 | 250 Units on Tape and Reel  |
| 2.4  | STD   | LP2985IBPX-2.4    |                 | 3000 Units on Tape and Reel |
| 2.5  | A     | LP2985AIBP-2.5    |                 | 250 Units on Tape and Reel  |
| 2.5  | A     | LP2985AIBPX-2.5   |                 | 3000 Units on Tape and Reel |
| 2.5  | STD   | LP2985IBP-2.5     |                 | 250 Units on Tape and Reel  |
| 2.5  | STD   | LP2985IBPX-2.5    |                 | 3000 Units on Tape and Reel |
| 2.6  | A     | LP2985AIBP-2.6    |                 | 250 Units on Tape and Reel  |

| Output Voltage (V)                                     | Grade | Order Information | Package Marking | Supplied as:                |
|--|-------|-------------------|-----------------|-----------------------------|
| 2.6  | A     | LP2985AIBPX-2.6   |                 | 3000 Units on Tape and Reel |
| 2.6  | STD   | LP2985IBP-2.6     |                 | 250 Units on Tape and Reel  |
| 2.6  | STD   | LP2985IBPX-2.6    |                 | 3000 Units on Tape and Reel |
| 2.8  | A     | LP2985AIBP-2.8    |                 | 250 Units on Tape and Reel  |
| 2.8  | A     | LP2985AIBPX-2.8   |                 | 3000 Units on Tape and Reel |
| 2.8  | STD   | LP2985IBP-2.8     |                 | 250 Units on Tape and Reel  |
| 2.8  | STD   | LP2985IBPX-2.8    |                 | 3000 Units on Tape and Reel |
| 2.9  | A     | LP2985AIBP-2.9    |                 | 250 Units on Tape and Reel  |
| 2.9  | A     | LP2985AIBPX-2.9   |                 | 3000 Units on Tape and Reel |
| 2.9  | STD   | LP2985IBP-2.9     |                 | 250 Units on Tape and Reel  |
| 2.9  | STD   | LP2985IBPX-2.9    |                 | 3000 Units on Tape and Reel |
| 3.0  | A     | LP2985AIBP-3.0    |                 | 250 Units on Tape and Reel  |
| 3.0  | A     | LP2985AIBPX-3.0   |                 | 3000 Units on Tape and Reel |
| 3.0  | STD   | LP2985IBP-3.0     |                 | 250 Units on Tape and Reel  |
| 3.0  | STD   | LP2985IBPX-3.0    |                 | 3000 Units on Tape and Reel |
| 3.3  | A     | LP2985AIBP-3.3    |                 | 250 Units on Tape and Reel  |
| 3.3  | A     | LP2985AIBPX-3.3   |                 | 3000 Units on Tape and Reel |
| 3.3  | STD   | LP2985IBP-3.3     |                 | 250 Units on Tape and Reel  |
| 3.3  | STD   | LP2985IBPX-3.3    |                 | 3000 Units on Tape and Reel |
| 3.6  | A     | LP2985AIBP-3.6    |                 | 250 Units on Tape and Reel  |
| 3.6  | A     | LP2985AIBPX-3.6   |                 | 3000 Units on Tape and Reel |
| 3.6  | STD   | LP2985IBP-3.6     |                 | 250 Units on Tape and Reel  |
| 3.6  | STD   | LP2985IBPX-3.6    |                 | 3000 Units on Tape and Reel |
| 4.0  | A     | LP2985AIBP-4.0    |                 | 250 Units on Tape and Reel  |
| 4.0  | A     | LP2985AIBPX-4.0   |                 | 3000 Units on Tape and Reel |
| 4.0  | STD   | LP2985IBP-4.0     |                 | 250 Units on Tape and Reel  |
| 4.0  | STD   | LP2985IBPX-4.0    |                 | 3000 Units on Tape and Reel |
| 5.0  | A     | LP2985AIBP-5.0    |                 | 250 Units on Tape and Reel  |
| 5.0  | A     | LP2985AIBPX-5.0   |                 | 3000 Units on Tape and Reel |
| 5.0  | STD   | LP2985IBP-5.0     |                 | 250 Units on Tape and Reel  |
| 5.0  | STD   | LP2985IBPX-5.0    |                 | 3000 Units on Tape and Reel |
| <b>micro SMD, 5 Bump Package (TPA05 - 170 µm ball)</b> |       |                   |                 |                             |
| 2.5  | A     | LP2985AITP-2.5    |                 | 250 Units on Tape and Reel  |
| 2.5  | A     | LP2985AITPX-2.5   |                 | 3000 Units on Tape and Reel |
| 2.5  | STD   | LP2985ITP-2.5     |                 | 250 Units on Tape and Reel  |
| 2.5  | STD   | LP2985ITPX-2.5    |                 | 3000 Units on Tape and Reel |
| 2.6  | A     | LP2985AITP-2.6    |                 | 250 Units on Tape and Reel  |
| 2.6  | A     | LP2985AITPX-2.6   |                 | 3000 Units on Tape and Reel |
| 2.6  | STD   | LP2985ITP-2.6     |                 | 250 Units on Tape and Reel  |
| 2.6  | STD   | LP2985ITPX-2.6    |                 | 3000 Units on Tape and Reel |
| 2.7  | A     | LP2985AITP-2.7    |                 | 250 Units on Tape and Reel  |
| 2.7  | A     | LP2985AITPX-2.7   |                 | 3000 Units on Tape and Reel |
| 2.7  | STD   | LP2985ITP-2.7     |                 | 250 Units on Tape and Reel  |
| 2.7  | STD   | LP2985ITPX-2.7    |                 | 3000 Units on Tape and Reel |
| 2.8  | A     | LP2985AITP-2.8    |                 | 250 Units on Tape and Reel  |
| 2.8  | A     | LP2985AITPX-2.8   |                 | 3000 Units on Tape and Reel |
| 2.8  | STD   | LP2985ITP-2.8     |                 | 250 Units on Tape and Reel  |
| 2.8  | STD   | LP2985ITPX-2.8    |                 | 3000 Units on Tape and Reel |
| 2.9  | A     | LP2985AITP-2.9    |                 | 250 Units on Tape and Reel  |

| Output Voltage (V)                                     | Grade | Order Information    | Package Marking | Supplied as:                |
|--|-------|----------------------|-----------------|-----------------------------|
| 2.9  | A     | LP2985AITPX-2.9      |                 | 3000 Units on Tape and Reel |
| 2.9  | STD   | LP2985ITP-2.9        |                 | 250 Units on Tape and Reel  |
| 2.9  | STD   | LP2985ITPX-2.9       |                 | 3000 Units on Tape and Reel |
| 3.0  | A     | LP2985AITP-3.0       |                 | 250 Units on Tape and Reel  |
| 3.0  | A     | LP2985AITPX-3.0      |                 | 3000 Units on Tape and Reel |
| 3.0  | STD   | LP2985ITP-3.0        |                 | 250 Units on Tape and Reel  |
| 3.0  | STD   | LP2985ITPX-3.0       |                 | 3000 Units on Tape and Reel |
| 3.3  | A     | LP2985AITP-3.3       |                 | 250 Units on Tape and Reel  |
| 3.3  | A     | LP2985AITPX-3.3      |                 | 3000 Units on Tape and Reel |
| 3.3  | STD   | LP2985ITP-3.3        |                 | 250 Units on Tape and Reel  |
| 3.3  | STD   | LP2985ITPX-3.3       |                 | 3000 Units on Tape and Reel |
| 5.0  | A     | LP2985AITP-5.0       |                 | 250 Units on Tape and Reel  |
| 5.0  | A     | LP2985AITPX-5.0      |                 | 3000 Units on Tape and Reel |
| 5.0  | STD   | LP2985ITP-5.0        |                 | 250 Units on Tape and Reel  |
| 5.0  | STD   | LP2985ITPX-5.0       |                 | 3000 Units on Tape and Reel |
| <b>micro SMD, 5 Bump Package (BLA05 - 300 µm ball)</b> |       |                      |                 |                             |
| 2.85   | A     | LP2985AIBL-285       |                 | 250 Units on Tape and Reel  |
| 2.85   | A     | LP2985AIBLX-285      |                 | 3000 Units on Tape and Reel |
| 2.85   | STD   | LP2985IBL-285        |                 | 250 Units on Tape and Reel  |
| 2.85   | STD   | LP2985IBLX-285       |                 | 3000 Units on Tape and Reel |
| 3.0  | A     | LP2985AIBL-3.0       |                 | 250 Units on Tape and Reel  |
| 3.0  | A     | LP2985AIBLX-3.0      |                 | 3000 Units on Tape and Reel |
| 3.0  | STD   | LP2985IBL-3.0        |                 | 250 Units on Tape and Reel  |
| 3.0  | STD   | LP2985IBLX-3.0       |                 | 3000 Units on Tape and Reel |
| 3.3  | A     | LP2985AIBL-3.3       |                 | 250 Units on Tape and Reel  |
| 3.3  | A     | LP2985AIBLX-3.3      |                 | 3000 Units on Tape and Reel |
| 3.3  | STD   | LP2985IBL-3.3        |                 | 250 Units on Tape and Reel  |
| 3.3  | STD   | LP2985IBLX-3.3       |                 | 3000 Units on Tape and Reel |
| <b>micro SMD, 5 Bump Package (TLA05 - 300 µm ball)</b> |       |                      |                 |                             |
| 3.3  | A     | LP2985AITL-3.3 NOPB  |                 | 250 Units on Tape and Reel  |
| 3.3  | A     | LP2985AITLX-3.3 NOPB |                 | 3000 Units on Tape and Reel |
| 3.3  | STD   | LP2985ITL-3.3 NOPB   |                 | 250 Units on Tape and Reel  |
| 3.3  | STD   | LP2985ITLX-3.3 NOPB  |                 | 3000 Units on Tape and Reel |

### Absolute Maximum Ratings (Note 1)

If Military/Aerospace specified devices are required, please contact the National Semiconductor Sales Office/ Distributors for availability and specifications.

|                                      |                 |
|--------------------------------------|-----------------|
| Storage Temperature Range            | -65°C to +150°C |
| Operating Junction Temperature Range | -40°C to +125°C |
| Lead Temp. (Soldering, 5 sec.)       | 260°C           |
| ESD Rating (Note 2)                  | 2 kV            |

### Power Dissipation (Note 3)

|   |                         |
|---|-------------------------|
| Input Supply Voltage (Survival)           | -0.3V to +16V           |
| Input Supply Voltage (Operating)          | 2.5V to +16V            |
| Shutdown Input Voltage (Survival)         | -0.3V to +16V           |
| Output Voltage (Survival, (Note 4))       | -0.3V to +9V            |
| I <sub>OUT</sub> (Survival)               | Short Circuit Protected |
| Input-Output Voltage (Survival, (Note 5)) | -0.3V to +16V           |

### Internally Limited

|                         |
|-------------------------|
| -0.3V to +16V           |
| 2.5V to +16V            |
| -0.3V to +16V           |
| -0.3V to +9V            |
| Short Circuit Protected |
| -0.3V to +16V           |

### Electrical Characteristics (Note 10)

Limits in standard typeface are for T<sub>J</sub> = 25°C. and limits in **boldface type** apply over the full operating temperature range. Unless otherwise specified: V<sub>IN</sub> = V<sub>O</sub>(NOM) + 1V, I<sub>L</sub> = 1 mA, C<sub>IN</sub> = 1 μF, C<sub>OUT</sub> = 4.7 μF, V<sub>ON/OFF</sub> = 2V.

| Symbol                             | Parameter                      | Conditions                                      | Typ         | LP2985AI-X.X<br>(Note 6) |              | LP2985I-X.X<br>(Note 6) |              | Units             |
|------------------------------------|--------------------------------|---|-------------|--------------------------|--------------|-------------------------|--------------|-------------------|
|                                    |                                |   |             | Min                      | Max          | Min                     | Max          |                   |
| ΔV <sub>O</sub>                    | Output Voltage Tolerance       | I <sub>L</sub> = 1 mA                           |             | -1.0                     | 1.0          | -1.5                    | 1.5          | %V <sub>NOM</sub> |
|                                    |                                | 1 mA ≤ I <sub>L</sub> ≤ 50 mA                   |             | -1.5                     | 1.5          | -2.5                    | 2.5          |                   |
|                                    |                                | 1 mA ≤ I <sub>L</sub> ≤ 150 mA                  |             | -2.5                     | 2.5          | -3.0                    | 3.0          |                   |
|                                    |                                |   |             | <b>-2.5</b>              | <b>2.5</b>   | <b>-3.5</b>             | <b>3.5</b>   |                   |
|                                    |                                |   |             | <b>-3.5</b>              | <b>3.5</b>   | <b>-4.0</b>             | <b>4.0</b>   |                   |
| $\frac{\Delta V_O}{\Delta V_{IN}}$ | Output Voltage Line Regulation | V <sub>O</sub> (NOM)+1V ≤ V <sub>IN</sub> ≤ 16V | 0.007       |                          | 0.014        |                         | 0.014        | %/V               |
|                                    |                                |   |             |                          | <b>0.032</b> |                         | <b>0.032</b> |                   |
| V <sub>IN</sub> -V <sub>O</sub>    | Dropout Voltage (Note 7)       | I <sub>L</sub> = 0                              | 1           |                          | 3            |                         | 3            | mV                |
|                                    |                                | I <sub>L</sub> = 1 mA                           | 7           |                          | 10           |                         | 10           |                   |
|                                    |                                | I <sub>L</sub> = 10 mA                          | 40          |                          | 60           |                         | 60           |                   |
|                                    |                                | I <sub>L</sub> = 50 mA                          | 120         |                          | 150          |                         | 150          |                   |
|                                    |                                | I <sub>L</sub> = 150 mA                         | 280         |                          | 350          |                         | 350          |                   |
|                                    |                                |   |             |                          | <b>5</b>     |                         | <b>5</b>     |                   |
|                                    |                                |   |             |                          | <b>15</b>    |                         | <b>15</b>    |                   |
|                                    |                                |   |             |                          | <b>90</b>    |                         | <b>90</b>    |                   |
|                                    |                                |   |             |                          | <b>225</b>   |                         | <b>225</b>   |                   |
|                                    |                                |   |             |                          | <b>575</b>   |                         | <b>575</b>   |                   |
| I <sub>GND</sub>                   | Ground Pin Current (Note 11)   | I <sub>L</sub> = 0                              | 65          |                          | 95           |                         | 95           | μA                |
|                                    |                                | I <sub>L</sub> = 1 mA                           | 75          |                          | 110          |                         | 110          |                   |
|                                    |                                | I <sub>L</sub> = 10 mA                          | 120         |                          | 220          |                         | 220          |                   |
|                                    |                                | I <sub>L</sub> = 50 mA                          | 350         |                          | 600          |                         | 600          |                   |
|                                    |                                | I <sub>L</sub> = 150 mA                         | 850         |                          | 1500         |                         | 1500         |                   |
|                                    |                                | V <sub>ON/OFF</sub> < 0.3V                      | 0.01        |                          | 0.8          |                         | 0.8          |                   |
|                                    |                                | V <sub>ON/OFF</sub> < 0.15V                     | <b>0.05</b> |                          | <b>2</b>     |                         | <b>2</b>     |                   |
| V <sub>ON/OFF</sub>                | ON/OFF Input Voltage (Note 8)  | High = O/P ON                                   | 1.4         | <b>1.6</b>               |              | <b>1.6</b>              | V            |                   |
|                                    |                                | Low = O/P OFF                                   | 0.55        |                          | <b>0.15</b>  | <b>0.15</b>             |              |                   |
| I <sub>ON/OFF</sub>                | ON/OFF Input Current           | V <sub>ON/OFF</sub> = 0                         | 0.01        |                          | <b>-2</b>    |                         | <b>-2</b>    | μA                |
|                                    |                                | V <sub>ON/OFF</sub> = 5V                        | 5           |                          | <b>15</b>    |                         | <b>15</b>    |                   |

| Symbol                                 | Parameter                  | Conditions  | Typ | LP2985AI-X.X<br>(Note 6) |     | LP2985I-X.X<br>(Note 6) |     | Units         |
|--|----------------------------|---|-----|--------------------------|-----|-------------------------|-----|---------------|
|  |                            |   |     | Min                      | Max | Min                     | Max |               |
| $e_n$                                  | Output Noise Voltage (RMS) | BW = 300 Hz to 50 kHz,<br>$C_{OUT} = 10 \mu\text{F}$<br>$C_{BYPASS} = 10 \text{nF}$ | 30  |                          |     |                         |     | $\mu\text{V}$ |
| $\frac{\Delta V_{OUT}}{\Delta V_{IN}}$ | Ripple Rejection           | $f = 1 \text{ kHz}$ , $C_{BYPASS} = 10 \text{nF}$<br>$C_{OUT} = 10 \mu\text{F}$     | 45  |                          |     |                         |     | dB            |
| $I_O(\text{SC})$                       | Short Circuit Current      | $R_L = 0$ (Steady State)<br>(Note 9)  | 400 |                          |     |                         |     | mA            |
| $I_O(\text{PK})$                       | Peak Output Current        | $V_{OUT} \geq V_O(\text{NOM}) - 5\%$  | 350 |                          |     |                         |     | mA            |

**Note 1:** "Absolute Maximum Ratings" indicate limits beyond which damage to the component may occur. Electrical specifications do not apply when operating the device outside of its rated operating conditions.

**Note 2:** The ESD rating of pins 3 and 4 for the SOT-23 package, or pins 5 and 2 for the micro SMD package, is 1 kV.

**Note 3:** The maximum allowable power dissipation is a function of the maximum junction temperature,  $T_J(\text{MAX})$ , the junction-to-ambient thermal resistance,  $\theta_{JA}$ , and the ambient temperature,  $T_A$ . The maximum allowable power dissipation at any ambient temperature is calculated using:

$$P(\text{MAX}) = \frac{T_J(\text{MAX}) - T_A}{\theta_{JA}}$$

Where the value of  $\theta_{JA}$  for the SOT-23 package is 220°C/W in a typical PC board mounting and the micro SMD package is 225°C/W. Exceeding the maximum allowable dissipation will cause excessive die temperature, and the regulator will go into thermal shutdown.

**Note 4:** For 12V option, output voltage survival: -0.3 to +16V. If used in a dual-supply system where the regulator load is returned to a negative supply, the LP2985 output must be diode-clamped to ground.

**Note 5:** The output PNP structure contains a diode between the  $V_{IN}$  to  $V_{OUT}$  terminals that is normally reverse-biased. Reversing the polarity from  $V_{IN}$  to  $V_{OUT}$  will turn on this diode.

**Note 6:** Limits are 100% production tested at 25°C. Limits over the operating temperature range are guaranteed through correlation using Statistical Quality Control (SQC) methods. The limits are used to calculate National's Average Outgoing Quality Level (AOQL).

**Note 7:** Dropout voltage is defined as the input to output differential at which the output voltage drops 100 mV below the value measured with a 1V differential.

**Note 8:** The ON/OFF input must be properly driven to prevent possible misoperation. For details, refer to Application Hints.

**Note 9:** The LP2985 has foldback current limiting which allows a high peak current when  $V_{OUT} > 0.5\text{V}$ , and then reduces the maximum output current as  $V_{OUT}$  is forced to ground (see Typical Performance Characteristics curves).

**Note 10:** Exposing the micro SMD device to direct sunlight will cause misoperation. See Application Hints for additional information.

**Note 11:** For 12V option, add 50  $\mu\text{A}$  to all ON state quiescent current values.



# Typical Performance Characteristics

Unless otherwise specified:  $C_{IN} = 1\mu F$ ,  $C_{OUT} = 4.7\mu F$ ,  $V_{IN} = V_{OUT}$  (NOM) +1,  $T_A = 25^\circ C$ , ON/OFF pin is tied to  $V_{IN}$ .

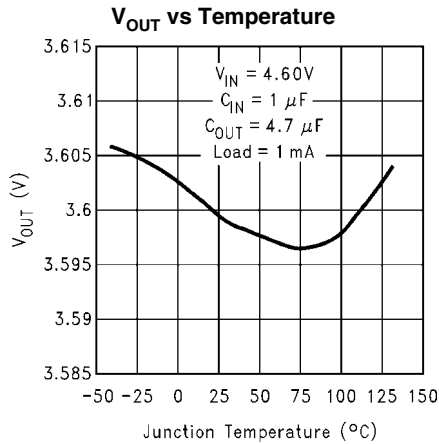

10014008

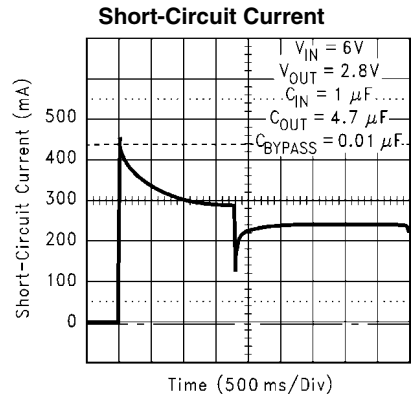

10014009

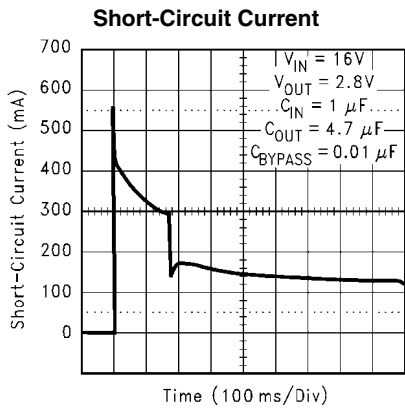

10014010

## Short Circuit Current vs Output Voltage

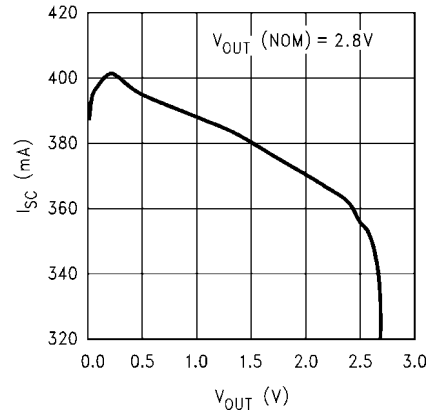

10014011

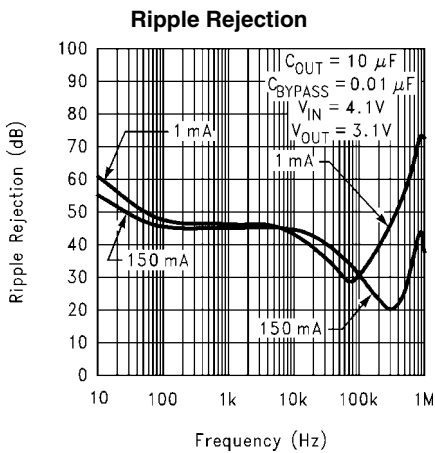

10014013

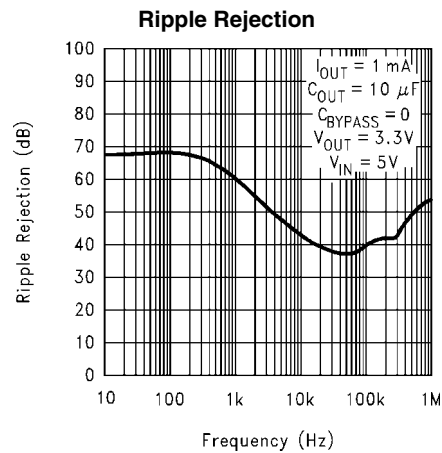

10014014

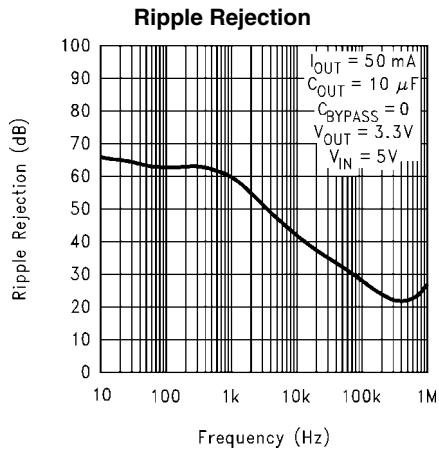

10014015

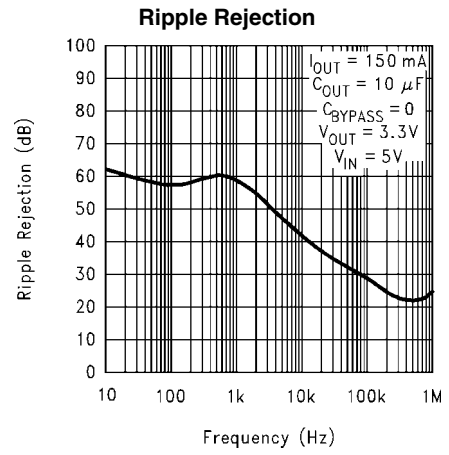

10014016

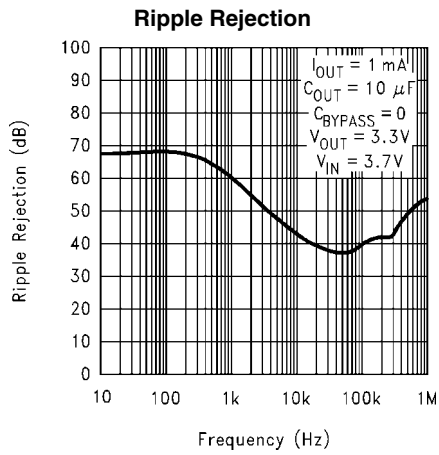

10014017

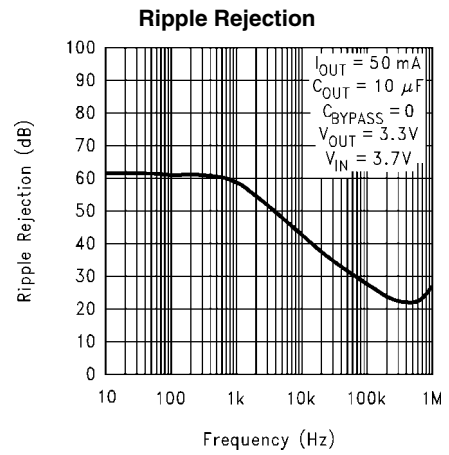

10014018

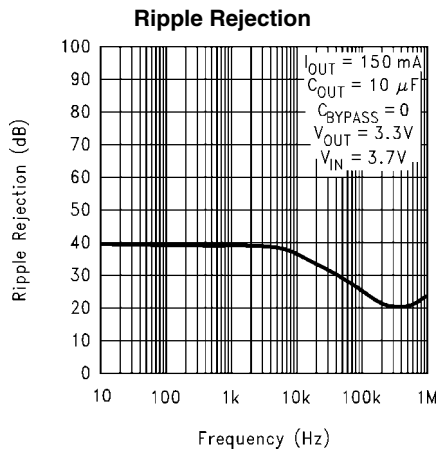

10014019

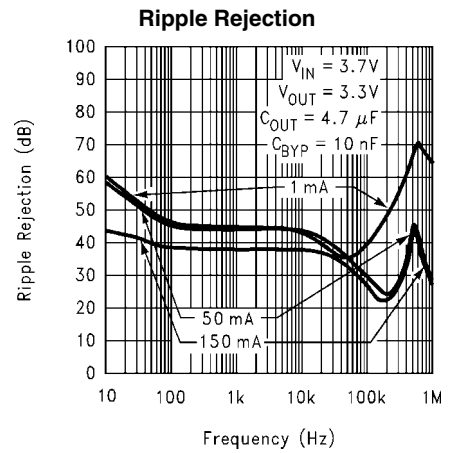

10014023

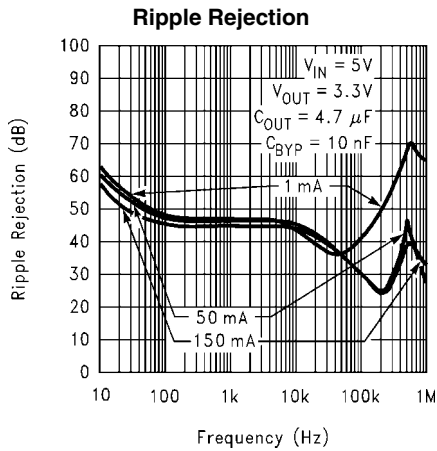

10014022

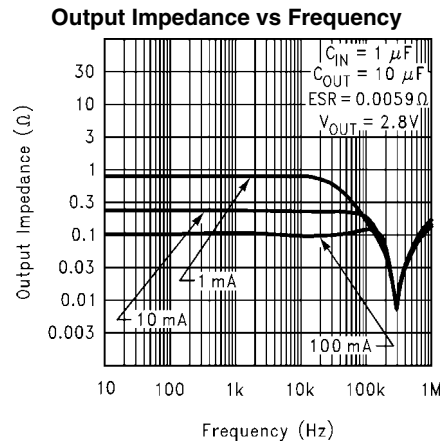

10014020

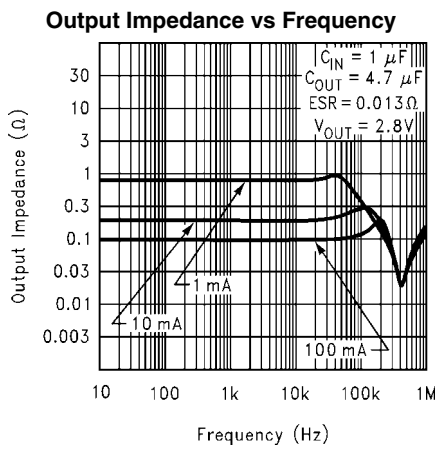

10014021

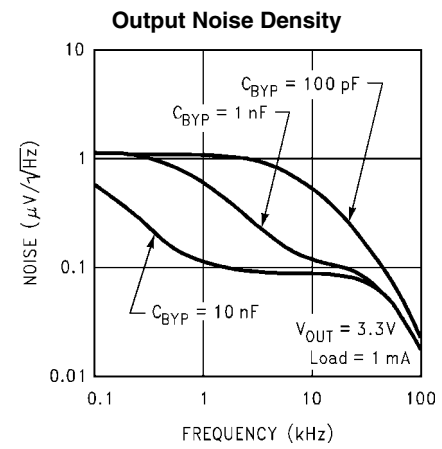

10014024

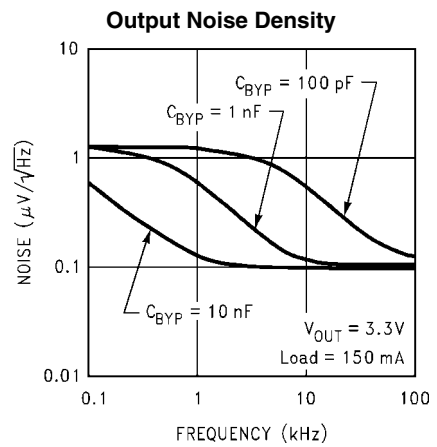

10014025

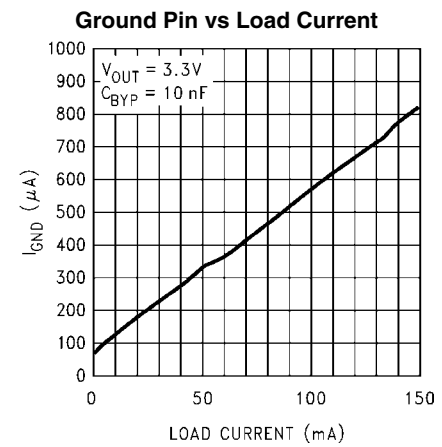

10014026

**Dropout Voltage vs Temperature**

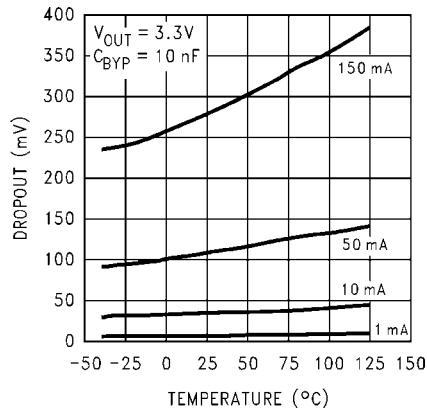

10014027

**Input Current vs Pin**

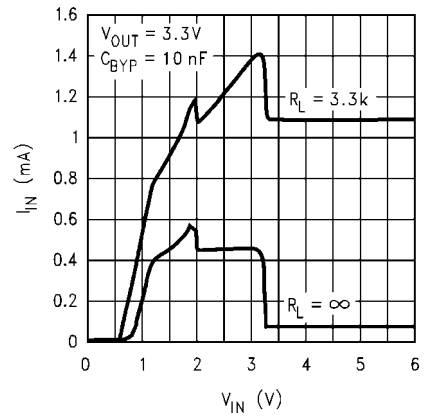

10014029

**GND Pin Current vs Temperature**

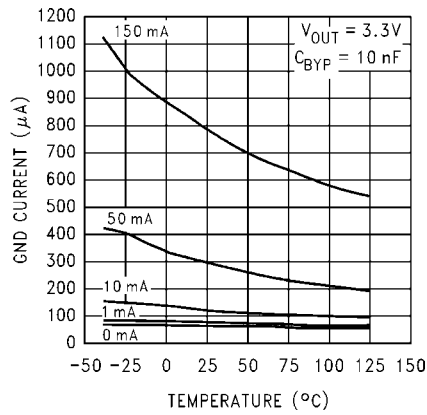

10014030

**Instantaneous Short Circuit Current**

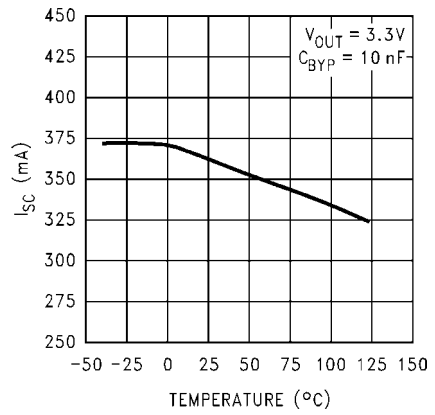

10014031

**Load Transient Response**

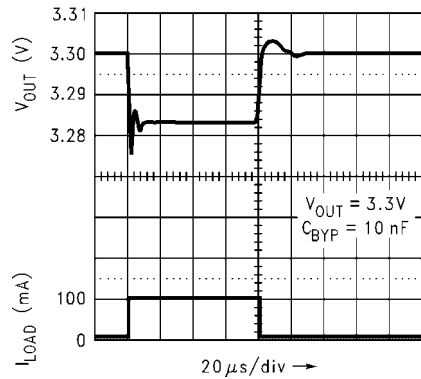

10014032

**Load Transient Response**

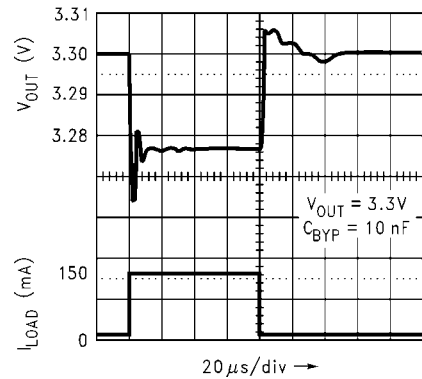

10014033

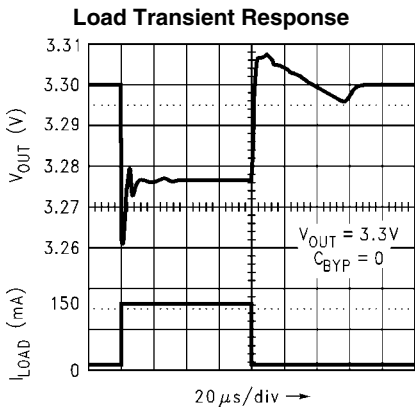

10014034

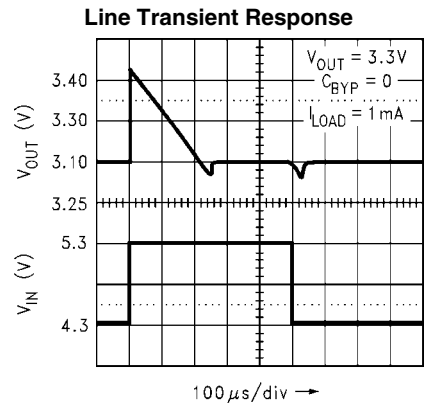

10014035

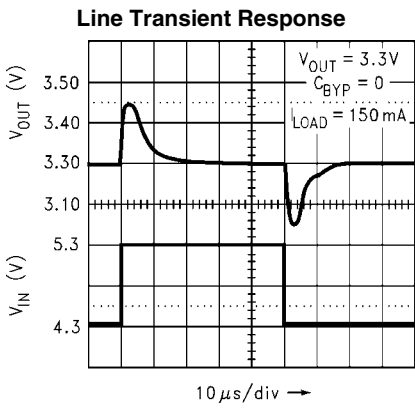

10014036

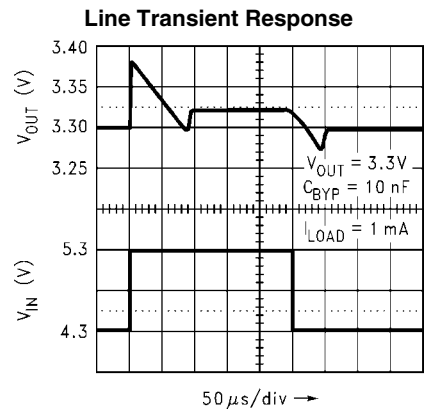

10014037

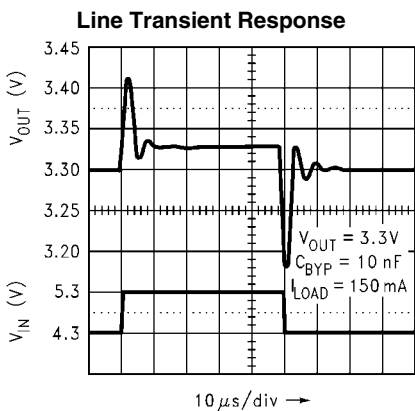

10014038

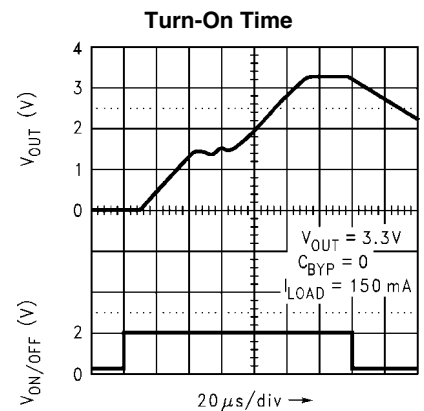

10014039

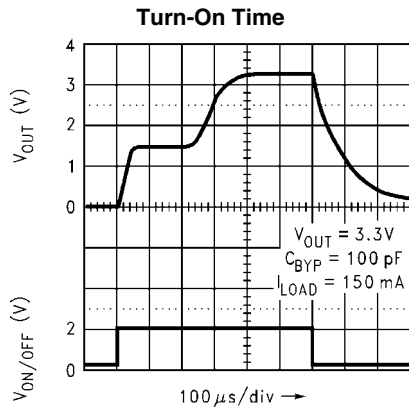

10014040

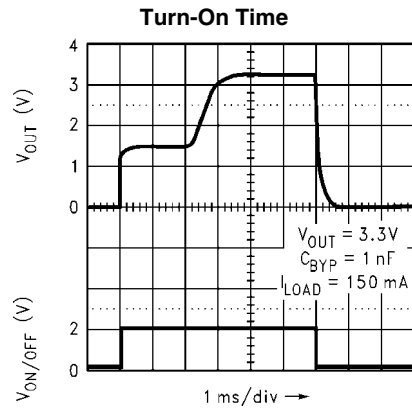

10014041

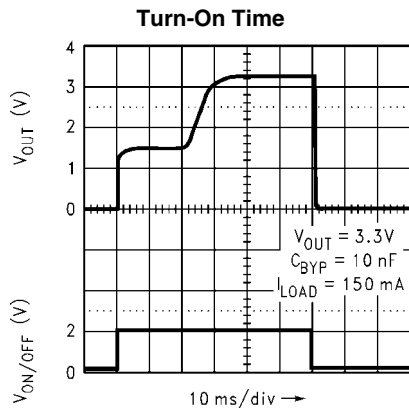

10014042

## Application Hints

### EXTERNAL CAPACITORS

Like any low-dropout regulator, the LP2985 requires external capacitors for regulator stability. These capacitors must be correctly selected for good performance.

#### Input Capacitor

An input capacitor whose capacitance is  $\geq 1 \mu\text{F}$  is required between the LP2985 input and ground (the amount of capacitance may be increased without limit).

This capacitor must be located a distance of not more than 1 cm from the input pin and returned to a clean analog ground. Any good quality ceramic, tantalum, or film capacitor may be used at the input.

**Important:** Tantalum capacitors can suffer catastrophic failure due to surge current when connected to a low-impedance source of power (like a battery or very large capacitor). If a Tantalum capacitor is used at the input, it must be guaranteed by the manufacturer to have a surge current rating sufficient for the application.

There are no requirements for ESR on the input capacitor, but tolerance and temperature coefficient must be considered

when selecting the capacitor to ensure the capacitance will be  $\geq 1 \mu\text{F}$  over the entire operating temperature range.

#### Output Capacitor

The LP2985 is designed specifically to work with ceramic output capacitors, utilizing circuitry which allows the regulator to be stable across the entire range of output current with an output capacitor whose ESR is as low as  $5 \text{ m}\Omega$ . It may also be possible to use Tantalum or film capacitors at the output, but these are not as attractive for reasons of size and cost (see next section Capacitor Characteristics).

The output capacitor must meet the requirement for minimum amount of capacitance and also have an ESR (equivalent series resistance) value which is within the stable range. Curves are provided which show the stable ESR range as a function of load current (see ESR graph below).

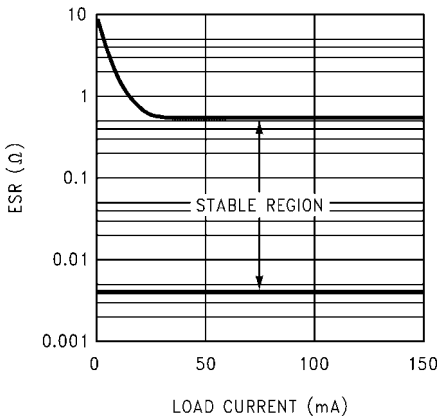

10014007

**Important:** The output capacitor must maintain its ESR within the stable region over the full operating temperature range of the application to assure stability.

The LP2985 requires a minimum of 2.2  $\mu\text{F}$  on the output (output capacitor size can be increased without limit).

It is important to remember that capacitor tolerance and variation with temperature must be taken into consideration when selecting an output capacitor so that the minimum required amount of output capacitance is provided over the full operating temperature range. It should be noted that ceramic capacitors can exhibit large changes in capacitance with temperature (see next section, *Capacitor Characteristics*).

The output capacitor must be located not more than 1 cm from the output pin and returned to a clean analog ground.

#### Noise Bypass Capacitor

Connecting a 10 nF capacitor to the Bypass pin significantly reduces noise on the regulator output. It should be noted that the capacitor is connected directly to a high-impedance circuit in the bandgap reference.

Because this circuit has only a few microamperes flowing in it, any significant loading on this node will cause a change in the regulated output voltage. For this reason, DC leakage current through the noise bypass capacitor must never exceed 100 nA, and should be kept as low as possible for best output voltage accuracy.

The types of capacitors best suited for the noise bypass capacitor are ceramic and film. High-quality ceramic capacitors with either NPO or COG dielectric typically have very low leakage. 10 nF polypropylene and polycarbonate film capacitors are available in small surface-mount packages and typically have extremely low leakage current.

#### CAPACITOR CHARACTERISTICS

The LP2985 was designed to work with ceramic capacitors on the output to take advantage of the benefits they offer: for capacitance values in the 2.2  $\mu\text{F}$  to 4.7  $\mu\text{F}$  range, ceramics are the least expensive and also have the lowest ESR values (which makes them best for eliminating high-frequency noise). The ESR of a typical 2.2  $\mu\text{F}$  ceramic capacitor is in the range of 10 m $\Omega$  to 20 m $\Omega$ , which easily meets the ESR limits required for stability by the LP2985.

One disadvantage of ceramic capacitors is that their capacitance can vary with temperature. Most large value ceramic capacitors ( $\geq 2.2 \mu\text{F}$ ) are manufactured with the Z5U or Y5V temperature characteristic, which results in the capacitance dropping by more than 50% as the temperature goes from 25°C to 85°C.

This could cause problems if a 2.2  $\mu\text{F}$  capacitor were used on the output since it will drop down to approximately 1  $\mu\text{F}$  at high ambient temperatures (which could cause the LM2985 to oscillate). If Z5U or Y5V capacitors are used on the output, a minimum capacitance value of 4.7  $\mu\text{F}$  must be observed.

A better choice for temperature coefficient in ceramic capacitors is X7R, which holds the capacitance within  $\pm 15\%$ . Unfortunately, the larger values of capacitance are not offered by all manufacturers in the X7R dielectric.

#### Tantalum

Tantalum capacitors are less desirable than ceramics for use as output capacitors because they are more expensive when comparing equivalent capacitance and voltage ratings in the 1  $\mu\text{F}$  to 4.7  $\mu\text{F}$  range.

Another important consideration is that Tantalum capacitors have higher ESR values than equivalent size ceramics. This means that while it may be possible to find a Tantalum capacitor with an ESR value within the stable range, it would have to be larger in capacitance (which means bigger and more costly) than a ceramic capacitor with the same ESR value.

It should also be noted that the ESR of a typical Tantalum will increase about 2:1 as the temperature goes from 25°C down to -40°C, so some guard band must be allowed.

#### On/Off Input Operation

The LP2985 is shut off by driving the ON/OFF input low, and turned on by pulling it high. If this feature is not to be used, the ON/OFF input should be tied to  $V_{\text{IN}}$  to keep the regulator output on at all times.

To assure proper operation, the signal source used to drive the ON/OFF input must be able to swing above and below the specified turn-on/turn-off voltage thresholds listed in the Electrical Characteristics section under  $V_{\text{ON/OFF}}$ . To prevent misoperation, the turn-on (and turn-off) voltage signals applied to the ON/OFF input must have a slew rate which is  $\geq 40 \text{ mV}/\mu\text{s}$ .

**Caution:** the regulator output voltage can not be guaranteed if a slow-moving AC (or DC) signal is applied that is in the range between the specified turn-on and turn-off voltages listed under the electrical specification  $V_{\text{ON/OFF}}$  (see Electrical Characteristics).

#### REVERSE INPUT-OUTPUT VOLTAGE

The PNP power transistor used as the pass element in the LP2985 has an inherent diode connected between the regulator output and input. During normal operation (where the input voltage is higher than the output) this diode is reverse-biased.

However, if the output is pulled above the input, this diode will turn ON and current will flow into the regulator output. In such cases, a parasitic SCR can latch which will allow a high current to flow into  $V_{\text{IN}}$  (and out the ground pin), which can damage the part.

In any application where the output may be pulled above the input, an external Schottky diode must be connected from  $V_{\text{IN}}$  to  $V_{\text{OUT}}$  (cathode on  $V_{\text{IN}}$ , anode on  $V_{\text{OUT}}$ ), to limit the reverse voltage across the LP2985 to 0.3V (see Absolute Maximum Ratings).

#### MICRO SMD MOUNTING

The micro SMD package requires specific mounting techniques which are detailed in National Semiconductor Application Note # 1112. Referring to the section **Surface Mount Technology (SMT) Assembly Considerations**, it should be

noted that the pad style which must be used with the 5-pin package is the NSMD (non-solder mask defined) type.

For best results during assembly, alignment ordinals on the PC board may be used to facilitate placement of the micro SMD device.

#### **MICRO SMD LIGHT SENSITIVITY**

Exposing the micro SMD device to direct sunlight will cause misoperation of the device. Light sources such as Halogen

lamps can also affect electrical performance if brought near to the device.

The wavelenghts which have the most detrimental effect are reds and infra-reds, which means that the fluorescent lighting used inside most buildings has very little effect on performance. A micro SMD test board was brought to within 1 cm of a fluorescent desk lamp and the effect on the regulated output voltage was negligible, showing a deviation of less than 0.1% from nominal.



**Physical Dimensions** inches (millimeters) unless otherwise noted

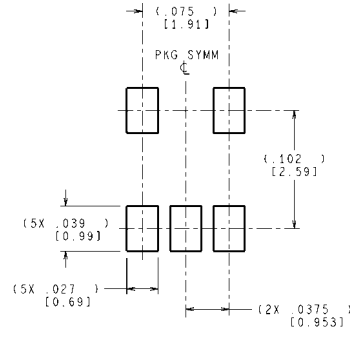
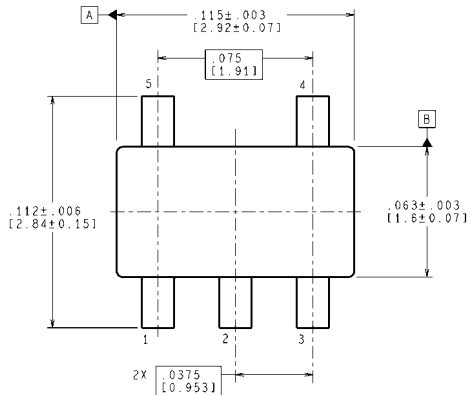

LAND PATTERN RECOMMENDATION

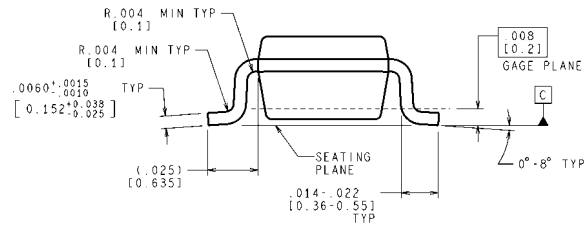
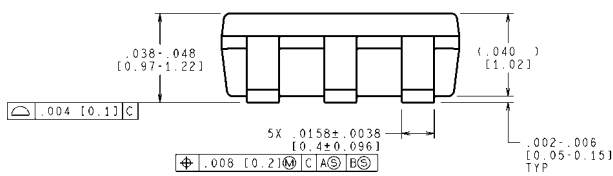

CONTROLLING DIMENSION IS INCH  
 VALUES IN [ ] ARE MILLIMETERS  
 DIMENSIONS IN ( ) FOR REFERENCE ONLY

MF05A (Rev C)

**5-Lead Small Outline Package (M5)  
 NS Package Number MF05A**

For Order Numbers, refer to *Table 1* in the "Ordering Information" section of this document.

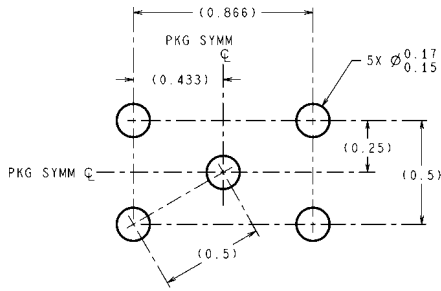

DIMENSIONS ARE IN MILLIMETERS  
DIMENSIONS IN ( ) FOR REFERENCE ONLY

LAND PATTERN RECOMMENDATION

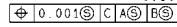
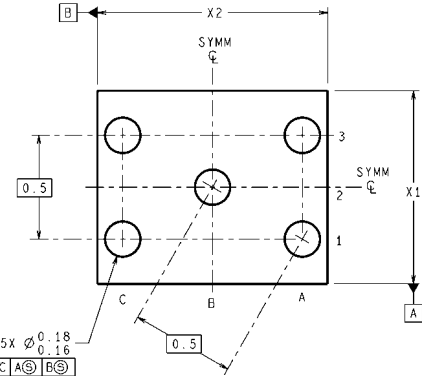
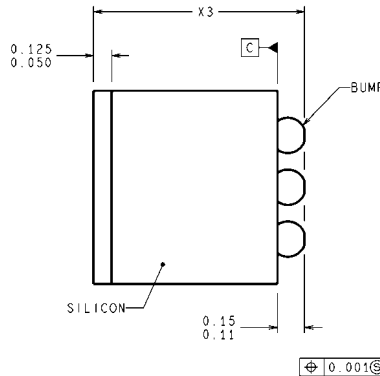
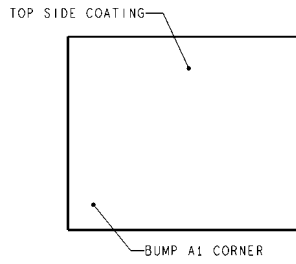

BPA05XXX (Rev D)

NOTES: UNLESS OTHERWISE SPECIFIED

1. EPOXY COATING
2. 63Sn/37Pb EUTECTIC BUMP
3. RECOMMEND NON-SOLDER MASK DEFINED LANDING PAD.
4. PIN 1 IS ESTABLISHED BY LOWER LEFT CORNER WITH RESPECT TO TEXT ORIENTATION. REMAINING PINS ARE NUMBERED COUNTER CLOCKWISE.
5. XXX IN DRAWING NUMBER REPRESENTS PACKAGE SIZE VARIATION WHERE X1 IS PACKAGE WIDTH, X2 IS PACKAGE LENGTH AND X3 IS PACKAGE HEIGHT.
6. NO JEDEC REGISTRATION AS OF AUG. 1999.

**micro SMD, 5 Bump, Package (BPA05)  
NS Package Number BPA05A**

**For Order Numbers, refer to Table 1 in the "Ordering Information" section of this document.**

**The dimensions for X1, X2 and X3 are as given:**

- X1 = 0.930 +/- 0.030mm**
- X2 = 1.107 +/- 0.030mm**
- X3 = 0.850 +/- 0.050mm**

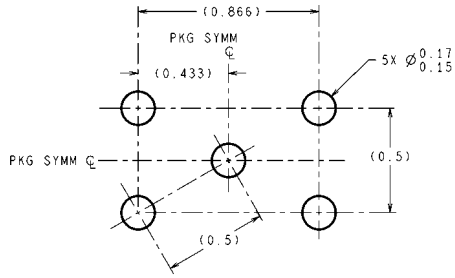

DIMENSIONS ARE IN MILLIMETERS  
DIMENSIONS IN ( ) FOR REFERENCE ONLY

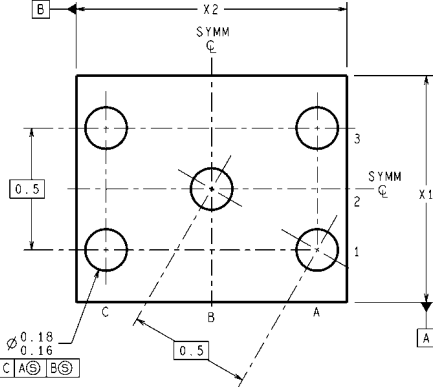
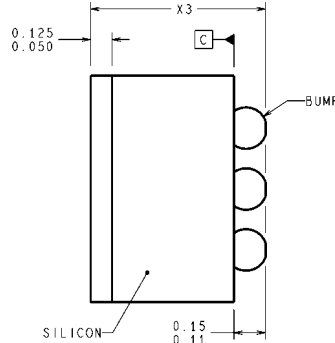
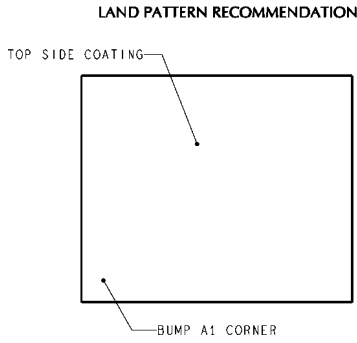

TPA05XXX (Rev C)

NOTES: UNLESS OTHERWISE SPECIFIED

1. EPOXY COATING
2. 63Sn/37Pb EUTECTIC BUMP
3. RECOMMEND NON-SOLDER MASK DEFINED LANDING PAD.
4. PIN 1 IS ESTABLISHED BY LOWER LEFT CORNER WITH RESPECT TO TEXT ORIENTATION. REMAINING PINS ARE NUMBERED COUNTER CLOCK-WISE.
5. XXX IN DRAWING NUMBER REPRESENTS PACKAGE SIZE VARIATION WHERE X1 IS PACKAGE WIDTH, X2 IS PACKAGE LENGTH AND X3 IS PACKAGE HEIGHT.
6. NO JEDEC REGISTRATION AS OF AUG.1999.

**micro SMD, 5 Bump, Package (TPA05 - 170 μm ball)  
NS Package Number TPA05**

For Order Numbers, refer to *Table 1 "Ordering Information"* section of this document.

The dimensions for X1, X2 and X3 are as given:

- X1 = 0.930 +/- 0.030mm
- X2 = 1.107 +/- 0.030mm
- X3 = 0.500 +/- 0.075mm

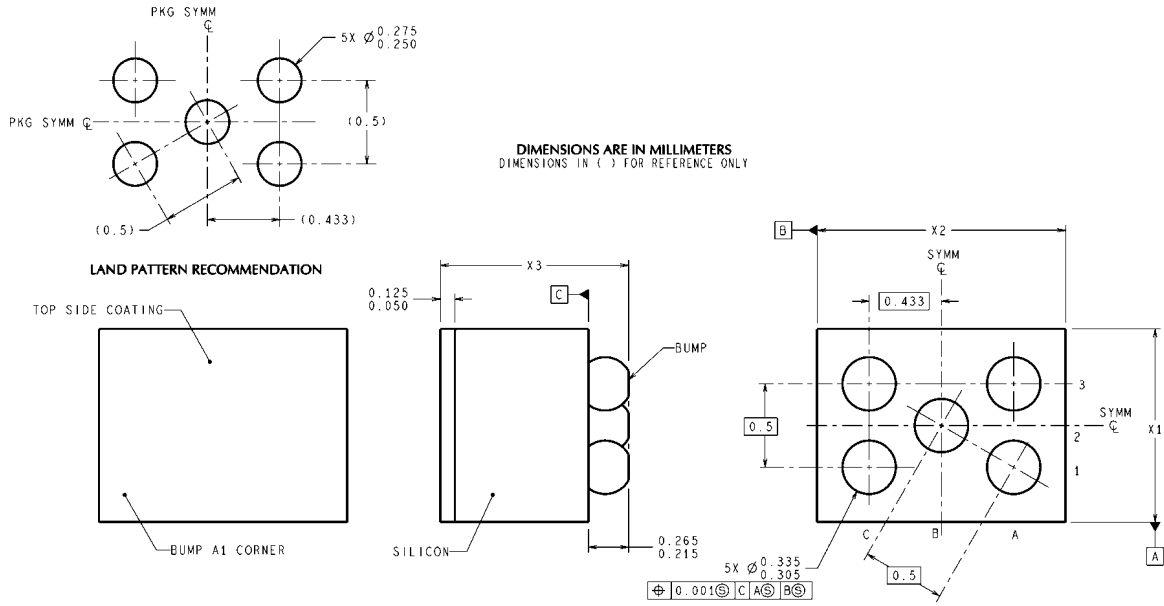

DIMENSIONS ARE IN MILLIMETERS  
DIMENSIONS IN ( ) FOR REFERENCE ONLY

BLA05XXX (Rev E)

NOTES: UNLESS OTHERWISE SPECIFIED

1. EPOXY COATING
2. 63Sn/37Pb EUTECTIC BUMP
3. RECOMMEND NON-SOLDER MASK DEFINED LANDING PAD.
4. PIN 1 IS ESTABLISHED BY LOWER LEFT CORNER WITH RESPECT TO TEXT ORIENTATION. REMAINING PINS ARE NUMBERED COUNTER CLOCK-WISE.
5. XXX IN DRAWING NUMBER REPRESENTS PACKAGE SIZE VARIATION WHERE X1 IS PACKAGE WIDTH, X2 IS PACKAGE LENGTH AND X3 IS PACKAGE HEIGHT.
6. NO JEDEC REGISTRATION AS OF AUG.1999.

**micro SMD, 5 Bump, Package (BLA05 - 300 μm ball)**  
**NS Package Number BLA05A**  
**For Order Numbers, refer to Table 1 "Ordering Information" section of this document.**  
**The dimensions for X1, X2 and X3 are as given:**  
**X1 = 1.057 +/- 0.030mm**  
**X2 = 1.412 +/- 0.030mm**  
**X3 = 0.945 +/- 0.100mm**

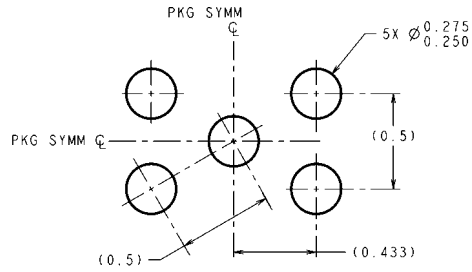

DIMENSIONS ARE IN MILLIMETERS  
DIMENSIONS IN ( ) FOR REFERENCE ONLY

LAND PATTERN RECOMMENDATION

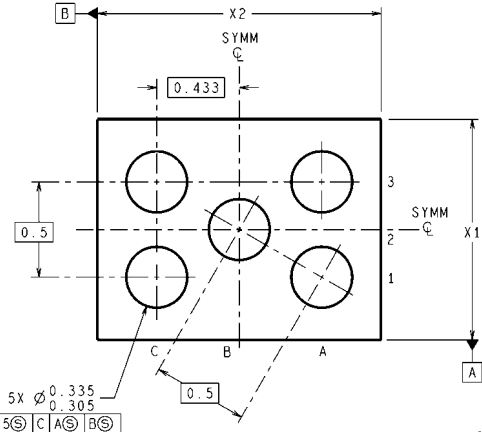
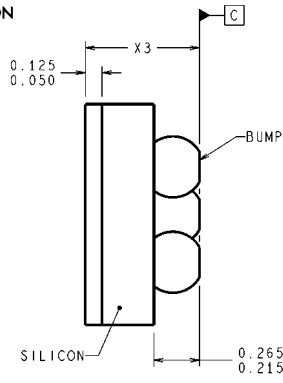
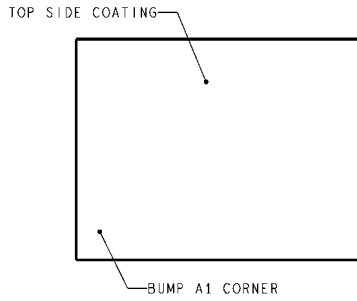

TLA05XXX (Rev C)

NOTES: UNLESS OTHERWISE SPECIFIED

1. EPOXY COATING
2. 63Sn/37Pb EUTECTIC BUMP
3. RECOMMEND NON-SOLDER MASK DEFINED LANDING PAD.
4. PIN 1 IS ESTABLISHED BY LOWER LEFT CORNER WITH RESPECT TO TEXT ORIENTATION. REMAINING PINS ARE NUMBERED COUNTER CLOCK-WISE.
5. XXX IN DRAWING NUMBER REPRESENTS PACKAGE SIZE VARIATION WHERE X1 IS PACKAGE WIDTH, X2 IS PACKAGE LENGTH AND X3 IS PACKAGE HEIGHT.
6. NO JEDEC REGISTRATION AS OF AUG. 1999.

micro SMD, 5 Bump, Package (TLA05 - 300 μm ball)  
NS Package Number TLA05

For Order Numbers, refer to *Table 1* "Ordering Information" section of this document.

The dimensions for X1, X2 and X3 are as given:

- X1 = 1.031 +/- 0.030mm
- X2 = 1.412 +/- 0.030mm
- X3 = 0.600 +/- 0.075mm

## Notes

THE CONTENTS OF THIS DOCUMENT ARE PROVIDED IN CONNECTION WITH NATIONAL SEMICONDUCTOR CORPORATION ("NATIONAL") PRODUCTS. NATIONAL MAKES NO REPRESENTATIONS OR WARRANTIES WITH RESPECT TO THE ACCURACY OR COMPLETENESS OF THE CONTENTS OF THIS PUBLICATION AND RESERVES THE RIGHT TO MAKE CHANGES TO SPECIFICATIONS AND PRODUCT DESCRIPTIONS AT ANY TIME WITHOUT NOTICE. NO LICENSE, WHETHER EXPRESS, IMPLIED, ARISING BY ESTOPPEL OR OTHERWISE, TO ANY INTELLECTUAL PROPERTY RIGHTS IS GRANTED BY THIS DOCUMENT.

TESTING AND OTHER QUALITY CONTROLS ARE USED TO THE EXTENT NATIONAL DEEMS NECESSARY TO SUPPORT NATIONAL'S PRODUCT WARRANTY. EXCEPT WHERE MANDATED BY GOVERNMENT REQUIREMENTS, TESTING OF ALL PARAMETERS OF EACH PRODUCT IS NOT NECESSARILY PERFORMED. NATIONAL ASSUMES NO LIABILITY FOR APPLICATIONS ASSISTANCE OR BUYER PRODUCT DESIGN. BUYERS ARE RESPONSIBLE FOR THEIR PRODUCTS AND APPLICATIONS USING NATIONAL COMPONENTS. PRIOR TO USING OR DISTRIBUTING ANY PRODUCTS THAT INCLUDE NATIONAL COMPONENTS, BUYERS SHOULD PROVIDE ADEQUATE DESIGN, TESTING AND OPERATING SAFEGUARDS.

EXCEPT AS PROVIDED IN NATIONAL'S TERMS AND CONDITIONS OF SALE FOR SUCH PRODUCTS, NATIONAL ASSUMES NO LIABILITY WHATSOEVER, AND NATIONAL DISCLAIMS ANY EXPRESS OR IMPLIED WARRANTY RELATING TO THE SALE AND/OR USE OF NATIONAL PRODUCTS INCLUDING LIABILITY OR WARRANTIES RELATING TO FITNESS FOR A PARTICULAR PURPOSE, MERCHANTABILITY, OR INFRINGEMENT OF ANY PATENT, COPYRIGHT OR OTHER INTELLECTUAL PROPERTY RIGHT.

### LIFE SUPPORT POLICY

**NATIONAL'S PRODUCTS ARE NOT AUTHORIZED FOR USE AS CRITICAL COMPONENTS IN LIFE SUPPORT DEVICES OR SYSTEMS WITHOUT THE EXPRESS PRIOR WRITTEN APPROVAL OF THE CHIEF EXECUTIVE OFFICER AND GENERAL COUNSEL OF NATIONAL SEMICONDUCTOR CORPORATION.** As used herein:

Life support devices or systems are devices which (a) are intended for surgical implant into the body, or (b) support or sustain life and whose failure to perform when properly used in accordance with instructions for use provided in the labeling can be reasonably expected to result in a significant injury to the user. A critical component is any component in a life support device or system whose failure to perform can be reasonably expected to cause the failure of the life support device or system or to affect its safety or effectiveness.

National Semiconductor and the National Semiconductor logo are registered trademarks of National Semiconductor Corporation. All other brand or product names may be trademarks or registered trademarks of their respective holders.

Copyright© 2007 National Semiconductor Corporation

For the most current product information visit us at [www.national.com](http://www.national.com)



**National Semiconductor Americas Customer Support Center**  
Email: [new.feedback@nsc.com](mailto:new.feedback@nsc.com)  
Tel: 1-800-272-9959

**National Semiconductor Europe Customer Support Center**  
Fax: +49 (0) 180-530-85-86  
Email: [europe.support@nsc.com](mailto:europe.support@nsc.com)  
Deutsch Tel: +49 (0) 69 9508 6208  
English Tel: +49 (0) 870 24 0 2171  
Français Tel: +33 (0) 1 41 91 8790

**National Semiconductor Asia Pacific Customer Support Center**  
Email: [ap.support@nsc.com](mailto:ap.support@nsc.com)

**National Semiconductor Japan Customer Support Center**  
Fax: 81-3-5639-7507  
Email: [jpn.feedback@nsc.com](mailto:jpn.feedback@nsc.com)  
Tel: 81-3-5639-7560