

70MHz/1mA Current Mode Feedback Amplifiers



The EL2170, EL2270, and EL2470 are single/dual/quad current-feedback operational amplifiers which achieve a -3dB bandwidth of 70MHz at a gain of +1 while consuming only 1mA of supply current per amplifier. They will operate with dual supplies ranging from $\pm 1.5V$ to $\pm 6V$, or from single supplies ranging from +3V to +12V. In spite of their low supply current, the EL2270 and the EL2470 can output 55mA while swinging to $\pm 4V$ on $\pm 5V$ supplies. The EL2170 can output 100mA with similar output swings. These attributes make the EL2170, EL2270, and EL2470 excellent choices for low power and/or low voltage cable-driver, HDSL, or RGB applications.

For applications where board space is extremely critical, the EL2170 is available in the tiny 5-pin SOT-23 package, which has a footprint 28% the size of an 8-pin SO. The EL2170, EL2270, and EL2470 are each also available in industry standard pinouts in PDIP and SO packages.

For single and dual applications with disable, consider the EL2176 (8-pin single) or EL2276 (14-pin dual). For higher speed applications where power is still a concern, consider the EL2180/EL2186 family which also comes in similar single, dual, triple and quad configurations. The EL2180/EL2186 family provides a -3dB bandwidth of 250MHz while consuming 3mA of supply current per amplifier.

Features

- Single (EL2170), dual (EL2270) & quad (EL2470) topologies
- 1mA supply current (per amplifier)
- 70MHz -3dB bandwidth
- Tiny SOT23-5 package (EL2170)
- Low cost
- Single- and dual-supply operation down to $\pm 1.5V$
- 0.15%/0.15° diff. gain/diff. phase into 150 Ω
- 800V/ μs slew rate
- Large output drive current - 100mA (EL2170), 55mA (EL2270), 55mA (EL2470)
- Also available with disable in single (EL2176) & dual (EL2276)
- Higher speed EL2180/EL2186 family available (3mA/250MHz) in single, dual, and quad

Applications

- Low power/battery applications
- HDSL amplifiers
- Video amplifiers
- Cable drivers
- RGB amplifiers
- Test equipment amplifiers
- Current to voltage converters

Ordering Information

PART NUMBER	PACKAGE	TAPE & REEL	PKG. NO.
EL2170CN	8-Pin PDIP	-	MDP0031
EL2170CS	8-Pin SO	-	MDP0027
EL2170CS-T7	8-Pin SO	7"	MDP0027
EL2170CS-T13	8-Pin SO	13"	MDP0027
EL2170CW-T7	5-Pin SOT-23*	7"	MDP0038
EL2170CW-T3	5-Pin SOT-23*	13"	MDP0038
EL2270CN	8-Pin PDIP	-	MDP0031
EL2270CS	8-Pin SO	-	MDP0027
EL2270CS-T7	8-Pin SO	7"	MDP0027
EL2270CS-T13	8-Pin SO	13"	MDP0027
EL2470CN	14-Pin PDIP	-	MDP0031
EL2470CS	14-Pin SO	-	MDP0027
EL2470CS-T7	14-Pin SO	7"	MDP0027
EL2470CS-T13	14-Pin SO	13"	MDP0027

NOTE: *EL2170CW symbol is .Bxxx where xxx represents date

Pinouts

EL2170
(8-PIN SO, PDIP)
TOP VIEW

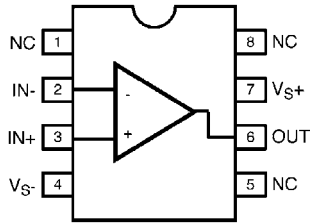

EL2270
(8-PIN SO, PDIP)
TOP VIEW

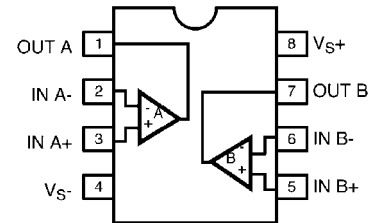

EL2170
(5-PIN SOT-23)
TOP VIEW

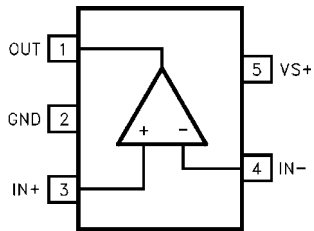

EL2470
(14-PIN SO, PDIP)
TOP VIEW

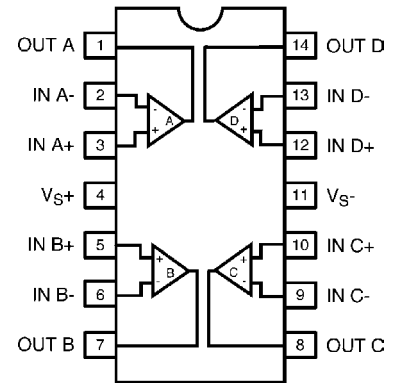

EL2170, EL2270, EL2470

Absolute Maximum Ratings ($T_A = 25^\circ\text{C}$)

Voltage between V_{S+} and V_{S-}	+12.6V
Common-Mode Input Voltage	V_{S-} to V_{S+}
Differential Input Voltage	$\pm 6\text{V}$
Current into +IN or -IN	$\pm 7.5\text{mA}$
Internal Power Dissipation	See Curves
Operating Ambient Temperature Range	-40°C to $+85^\circ\text{C}$

Operating Junction Temperature	
Plastic Packages	150°C
Output Current (EL2170)	$\pm 120\text{mA}$
Output Current (EL2270)	$\pm 60\text{mA}$
Output Current (EL2470)	$\pm 60\text{mA}$
Storage Temperature Range	-65°C to $+150^\circ\text{C}$

CAUTION: Stresses above those listed in "Absolute Maximum Ratings" may cause permanent damage to the device. This is a stress only rating and operation of the device at these or any other conditions above those indicated in the operational sections of this specification is not implied.

IMPORTANT NOTE: All parameters having Min/Max specifications are guaranteed. Typical values are for information purposes only. Unless otherwise noted, all tests are at the specified temperature and are pulsed tests, therefore: $T_J = T_C = T_A$

DC Electrical Specifications $V_S = \pm 5\text{V}$, $R_L = 150\Omega$, $T_A = 25^\circ\text{C}$ unless otherwise specified.

PARAMETER	DESCRIPTION	CONDITIONS	MIN	TYP	MAX	UNIT
V_{OS}	Input Offset Voltage			2.5	15	mV
TCV_{OS}	Average Input Offset Voltage Drift	Measured from T_{MIN} to T_{MAX}		5		$\mu\text{V}/^\circ\text{C}$
dV_{OS}	V_{OS} Matching	EL2270, EL2470 only		0.5		mV
$+I_{IN}$	+Input Current			0.5	5	μA
$d+I_{IN}$	$+I_{IN}$ Matching	EL2270, EL2470 only		20		nA
$-I_{IN}$	-Input Current			4	15	μA
$d-I_{IN}$	$-I_{IN}$ Matching	EL2270, EL2470 only		1.5		μA
CMRR	Common Mode Rejection Ratio	$V_{CM} = \pm 3.5\text{V}$	45	50		dB
-ICMR	-Input Current Common Mode Rejection	$V_{CM} = \pm 3.5\text{V}$		4	10	$\mu\text{A}/\text{V}$
PSRR	Power Supply Rejection Ratio	V_S is moved from $\pm 4\text{V}$ to $\pm 6\text{V}$	60	70		dB
-IPSR	-Input Current Power Supply Rejection	V_S is moved from $\pm 4\text{V}$ to $\pm 6\text{V}$		0.5	5	$\mu\text{A}/\text{V}$
R_{OL}	Transimpedance	$V_{OUT} = \pm 2.5\text{V}$	150	400		$\text{k}\Omega$
$+R_{IN}$	+Input Resistance	$V_{CM} = \pm 3.5\text{V}$	1	4		$\text{M}\Omega$
$+C_{IN}$	+Input Capacitance			1.2		pF
CMIR	Common Mode Input Range		± 3.5	± 4.0		V
V_O	Output Voltage Swing	$V_S = \pm 5$	± 3.5	± 4.0		V
		$V_S = 5$ single-supply, high		4.0		V
		$V_S = 5$ single-supply, low		0.3		V
I_O	Output Current	EL2170 only	80	100		mA
		EL2270 only, per amplifier	50	55		mA
		EL2470 only, per amplifier	50	55		mA
I_S	Supply Current	Per amplifier		1	2	mA

AC Electrical Specifications $V_S = \pm 5\text{V}$, $R_F = R_G = 1\text{k}\Omega$, $R_L = 150\Omega$, $T_A = 25^\circ\text{C}$ unless otherwise specified

PARAMETER	DESCRIPTION	CONDITIONS	MIN	TYP	MAX	UNIT
-3dB BW	-3dB Bandwidth	$A_V = 1$		70		MHz
-3dB BW	-3dB Bandwidth	$A_V = 2$		60		MHz
SR	Slew Rate	$V_{OUT} = \pm 2.5\text{V}$, $A_V = 2$	400	800		$\text{V}/\mu\text{s}$
t_R, t_F	Rise and Fall Time	$V_{OUT} = \pm 500\text{mV}$		4.5		ns

EL2170, EL2270, EL2470

AC Electrical Specifications $V_S = \pm 5V$, $R_F = R_G = 1k\Omega$, $R_L = 150\Omega$, $T_A = 25^\circ C$ unless otherwise specified (Continued)

PARAMETER	DESCRIPTION	CONDITIONS	MIN	TYP	MAX	UNIT
t_{PD}	Propagation Delay	$V_{OUT} = \pm 500mV$		4.5		ns
OS	Overshoot	$V_{OUT} = \pm 500mV$		3.0		%
t_S	0.1% Settling	$V_{OUT} = \pm 2.5V$, $A_V = -1$		40		ns
dG	Differential Gain	$A_V = 2$, $R_L = 150\Omega$ (Note 1)		0.15		%
dP	Differential Phase	$A_V = 2$, $R_L = 150\Omega$ (Note 1)		0.15		°
dG	Differential Gain	$A_V = 1$, $R_L = 500\Omega$ (Note 1)		0.02		%
dP	Differential Phase	$A_V = 1$, $R_L = 500\Omega$ (Note 1)		0.01		°
C_S	Channel Separation	EL2270, EL2470 only, $f = 5MHz$		85		dB

NOTE:

- DC offset from 0V to 0.714V, AC amplitude 286mV_{p-p}, $f = 3.58MHz$.

Test Circuit (per Amplifier)

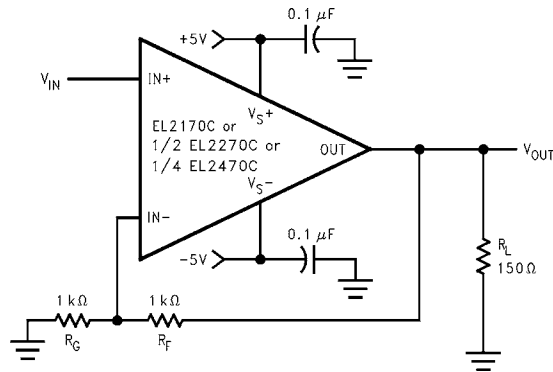

Simplified Schematic (per Amplifier)

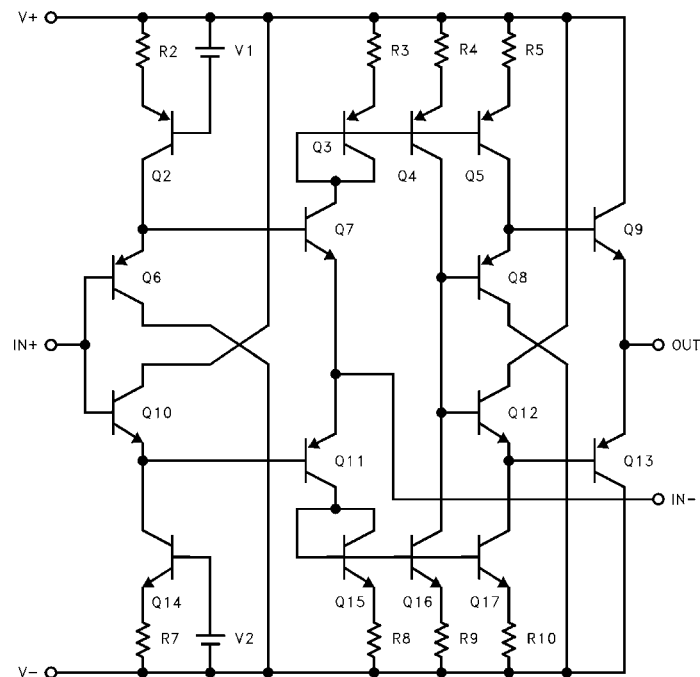

Typical Performance Curves

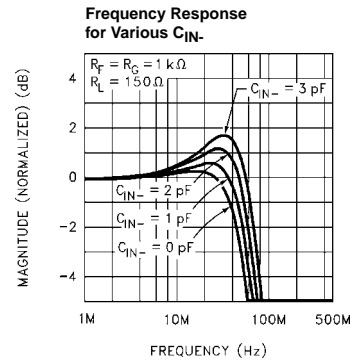
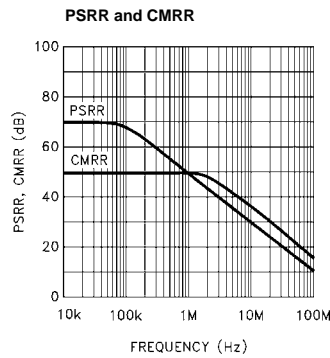
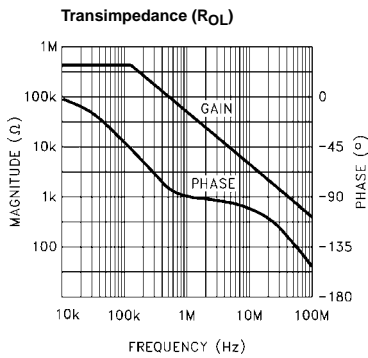
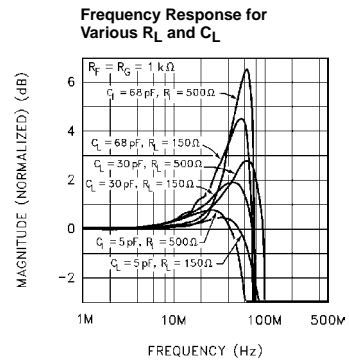
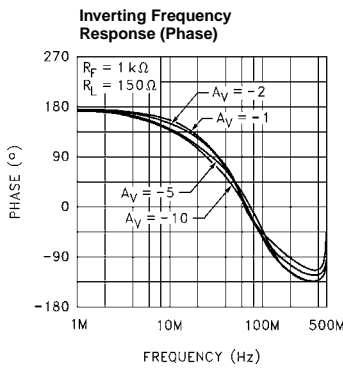
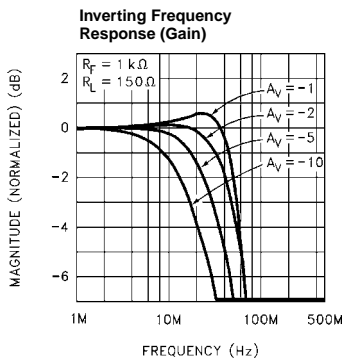
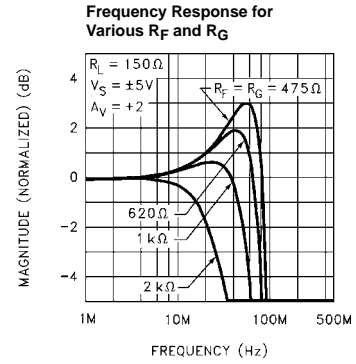
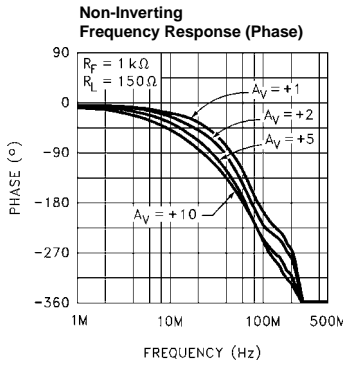
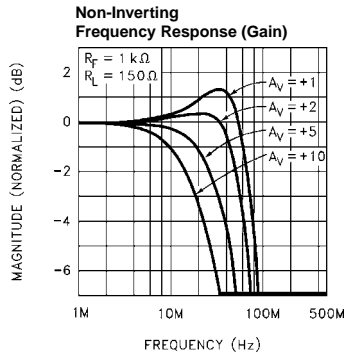

Typical Performance Curves (Continued)

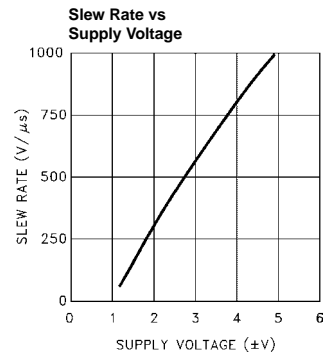
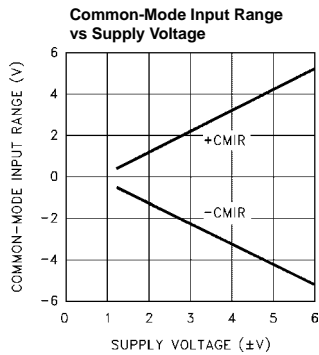
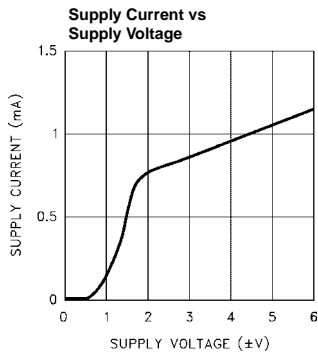
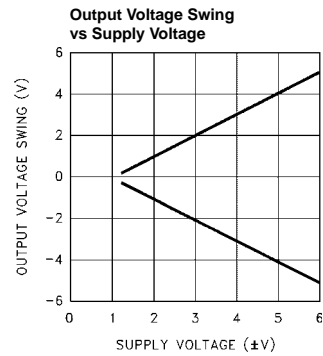
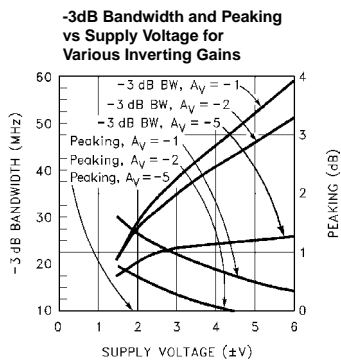
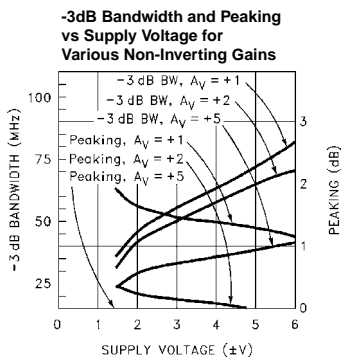
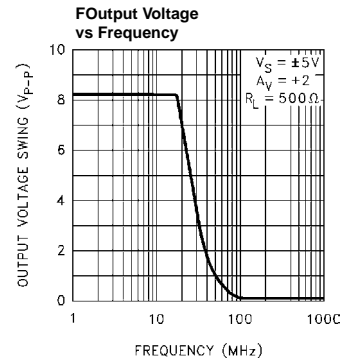
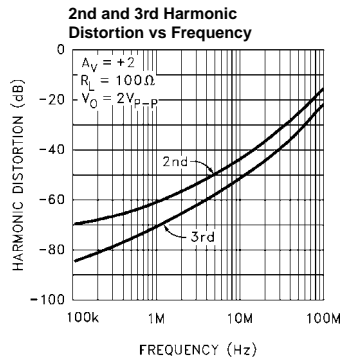
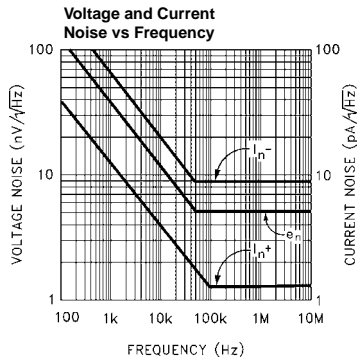

Typical Performance Curves (Continued)

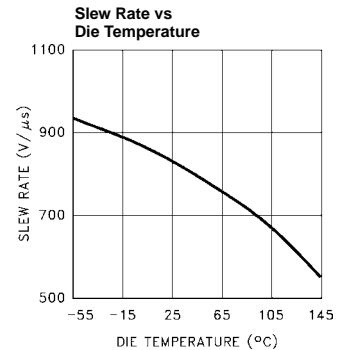
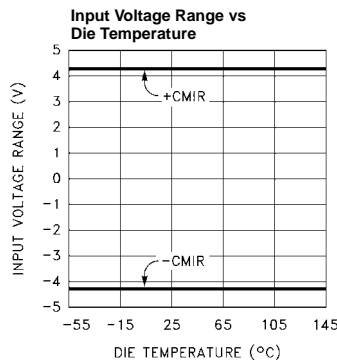
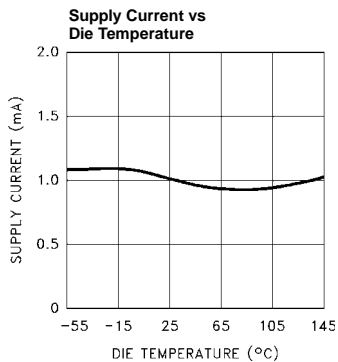
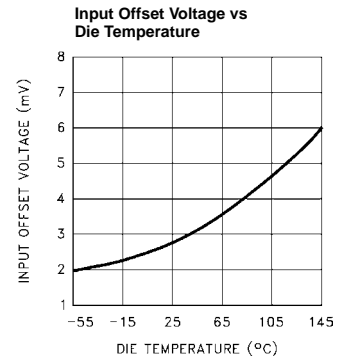
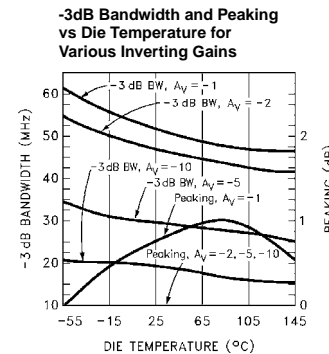
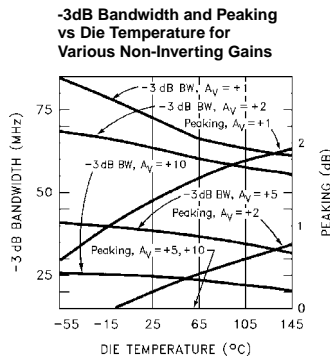
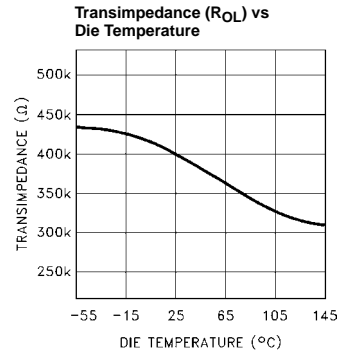
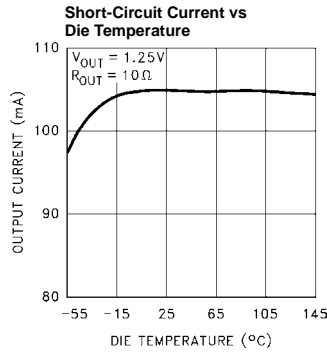
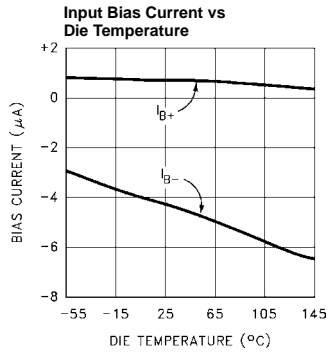

Typical Performance Curves (Continued)

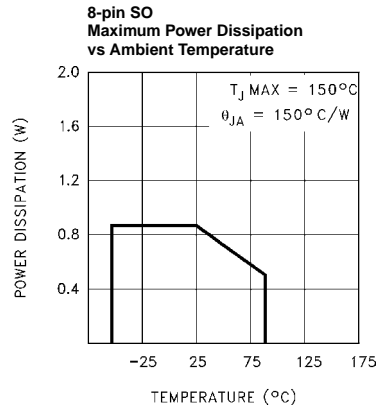
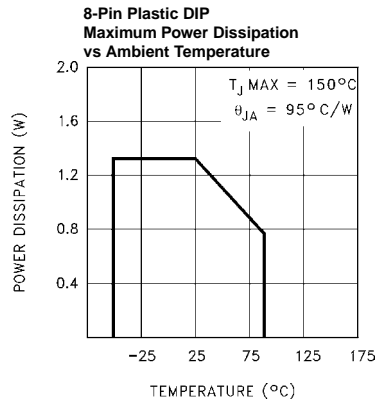
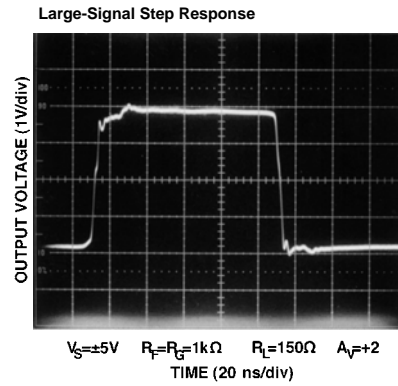
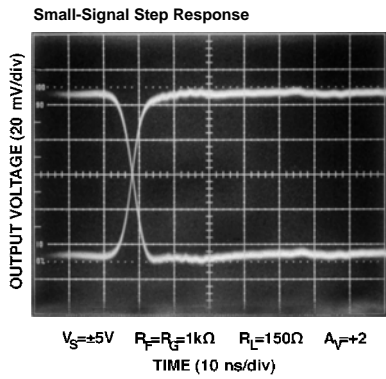
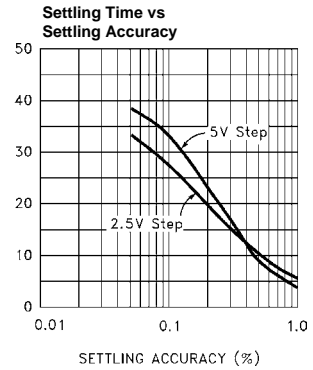
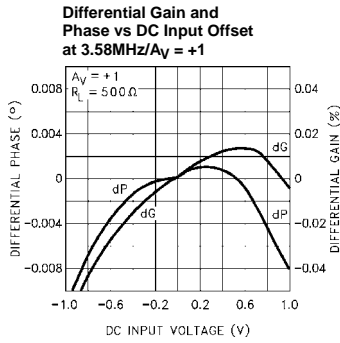
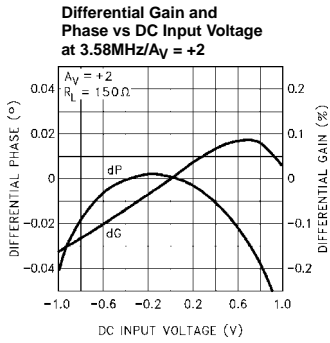

Typical Performance Curves (Continued)

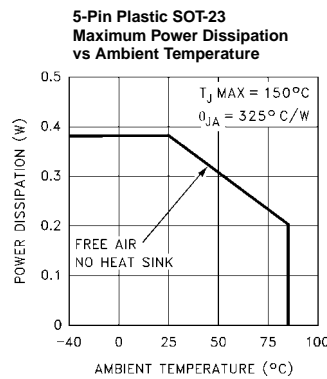
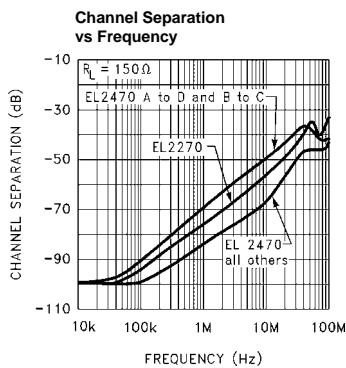
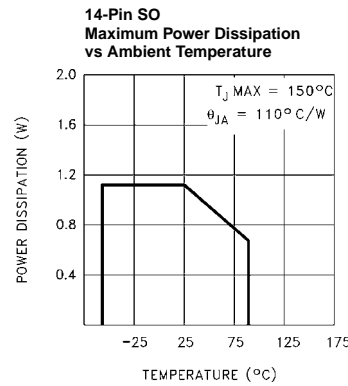
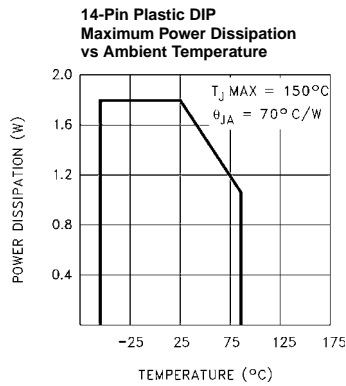

Applications Information

Product Description

The EL2170, EL2270, and EL2470 are current-feedback operational amplifiers that offer a wide -3dB bandwidth of 70MHz and a low supply current of 1mA per amplifier. All of these products also feature high output current drive. The EL2170 can output 100mA, while the EL2270 and the EL2470 can output 55mA per amplifier. The EL2170, EL2270, and EL2470 work with supply voltages ranging from a single 3V to $\pm 6V$, and they are also capable of swinging to within 1V of either supply on the input and the output. Because of their current-feedback topology, the EL2170, EL2270, and EL2470 do not have the normal gain-bandwidth product associated with voltage-feedback operational amplifiers. This allows their -3dB bandwidth to remain relatively constant as closed-loop gain is increased. This combination of high bandwidth and low power, together with aggressive pricing make the EL2170, EL2270, and EL2470 the ideal choice for many low-power/high-bandwidth applications such as portable computing, HDSL, and video processing.

For applications where board space is extremely critical, the EL2170 is available in the tiny 5-pin SOT-23 package, which has a footprint 28% the size of an 8-pin SO. The EL2170,

EL2270, and EL2470 are each also available in industry standard pinouts in PDIP and SO packages.

For single and dual applications with disable, consider the EL2176 (8-pin single) and EL2276 (14-pin dual). If higher speed is required, refer to the EL2180/EL2186 family which provides singles, duals, triples, and quads with 250MHz of bandwidth while consuming 3mA of supply current per amplifier.

Power Supply Bypassing and Printed Circuit Board Layout

As with any high-frequency device, good printed circuit board layout is necessary for optimum performance. Ground plane construction is highly recommended. Lead lengths should be as short as possible. The power supply pins must be well bypassed to reduce the risk of oscillation. The combination of a 4.7 μF tantalum capacitor in parallel with a 0.1 μF capacitor has been shown to work well when placed at each supply pin.

For good AC performance, parasitic capacitance should be kept to a minimum especially at the inverting input (see the Capacitance at the Inverting Input section). Ground plane construction should be used, but it should be removed from the area near the inverting input to minimize any stray capacitance at that node. Carbon or Metal-Film resistors are

acceptable with the Metal-Film resistors giving slightly less peaking and bandwidth because of their additional series inductance. Use of sockets, particularly for the SO package should be avoided if possible. Sockets add parasitic inductance and capacitance which will result in some additional peaking and overshoot.

Capacitance at the Inverting Input

Any manufacturer's high-speed voltage- or current-feedback amplifier can be affected by stray capacitance at the inverting input. For inverting gains this parasitic capacitance has little effect because the inverting input is a virtual ground, but for non-inverting gains this capacitance (in conjunction with the feedback and gain resistors) creates a pole in the feedback path of the amplifier. This pole, if low enough in frequency, has the same destabilizing effect as a zero in the forward open-loop response. The use of large value feedback and gain resistors further exacerbates the problem by further lowering the pole frequency.

The experienced user with a large amount of PC board layout experience may find in rare cases that the EL2170, EL2270, and EL2470 have less bandwidth than expected. The reduction of feedback resistor values (or the addition of a very small amount of external capacitance at the inverting input, e.g. 0.5pF) will increase bandwidth as desired. Please see the curves for Frequency Response for Various R_F and R_G , and Frequency Response for Various C_{IN} .

Feedback Resistor Values

The EL2170, EL2270, and EL2470 have been designed and specified at gains of +1 and +2 with $R_F = 1k\Omega$. This value of feedback resistor gives 70MHz of -3dB bandwidth at $A_V = +1$ with about 1.5dB of peaking, and 60MHz of -3dB bandwidth at $A_V = +2$ with about 0.5dB of peaking. Since the EL2170, EL2270, and EL2470 are current-feedback amplifiers, it is also possible to change the value of R_F to get more bandwidth. As seen in the curve of Frequency Response For Various R_F and R_G , bandwidth and peaking can be easily modified by varying the value of the feedback resistor.

Because the EL2170, EL2270, and EL2470 are current-feedback amplifiers, their gain-bandwidth product is not a constant for different closed-loop gains. This feature actually allows the EL2170, EL2270, and EL2470 to maintain about the same -3dB bandwidth, regardless of closed-loop gain. However, as closed-loop gain is increased, bandwidth decreases slightly while stability increases. Since the loop stability is improving with higher closed-loop gains, it becomes possible to reduce the value of R_F below the specified $1k\Omega$ and still retain stability, resulting in only a slight loss of bandwidth with increased closed-loop gain.

Supply Voltage Range and Single-Supply Operation

The EL2170, EL2270, and EL2470 have been designed to operate with supply voltages having a span of greater than 3V, and less than 12V. In practical terms, this means that the

EL2170, EL2270, and EL2470 will operate on dual supplies ranging from $\pm 1.5V$ to $\pm 6V$. With a single-supply, the EL2170, EL2270, and EL2470 will operate from +3V to +12V.

As supply voltages continue to decrease, it becomes necessary to provide input and output voltage ranges that can get as close as possible to the supply voltages. The EL2170, EL2270, and EL2470 have an input voltage range that extends to within 1V of either supply. So, for example, on a single +5V supply, the EL2170, EL2270, and EL2470 have an input range which spans from 1V to 4V. The output range of the EL2170, EL2270, and EL2470 is also quite large, extending to within 1V of the supply rail. On a $\pm 5V$ supply, the output is therefore capable of swinging from -4V to +4V. single-supply output range is even larger because of the increased negative swing due to the external pull-down resistor to ground. On a single +5V supply, output voltage range is about 0.3V to 4V.

Video Performance

For good video performance, an amplifier is required to maintain the same output impedance and the same frequency response as DC levels are changed at the output. This is especially difficult when driving a standard video load of 150Ω , because of the change in output current with DC level. Until the EL2170, EL2270, and EL2470, good Differential Gain could only be achieved by running high idle currents through the output transistors (to reduce variations in output impedance). These currents were typically more than the entire 1mA supply current of each EL2170, EL2270, and EL2470 amplifier! Special circuitry has been incorporated in the EL2170, EL2270, and EL2470 to reduce the variation of output impedance with current output. This results in dG and dP specifications of 0.15% and 0.15° while driving 150Ω at a gain of +2.

Video performance has also been measured with a 500Ω load at a gain of +1. Under these conditions, the EL2170, EL2270, and EL2470 have dG and dP specifications of 0.01% and 0.02° respectively while driving 500Ω at $A_V = +1$.

Output Drive Capability

In spite of its low 1mA of supply current, the EL2170 is capable of providing a minimum of $\pm 80mA$ of output current. Similarly, each amplifier of the EL2270 and the EL2470 is capable of providing a minimum of $\pm 50mA$. These output drive levels are unprecedented in amplifiers running at these supply currents. With a minimum $\pm 80mA$ of output drive, the EL2170 is capable of driving 50Ω loads to $\pm 4V$, making it an excellent choice for driving isolation transformers in telecommunications applications. Similarly, the $\pm 50mA$ minimum output drive of each EL2270 and EL2470 amplifier allows swings of $\pm 2.5V$ into 50Ω loads.

Driving Cables and Capacitive Loads

When used as a cable driver, double termination is always recommended for reflection-free performance. For those applications, the back-termination series resistor will decouple the EL2170, EL2270, and EL2470 from the cable and allow extensive capacitive drive. However, other applications may have high capacitive loads without a back-termination resistor. In these applications, a small series resistor (usually between 5Ω and 50Ω) can be placed in series with the output to eliminate most peaking. The gain resistor (R_G) can then be chosen to make up for any gain loss which may be created by this additional resistor at the output. In many cases it is also possible to simply increase the value of the feedback resistor (R_F) to reduce the peaking.

Current Limiting

The EL2170, EL2270, and EL2470 have no internal current-limiting circuitry. If any output is shorted, it is possible to exceed the Absolute Maximum Ratings for output current or power dissipation, potentially resulting in the destruction of the device.

Power Dissipation

With the high output drive capability of the EL2170, EL2270, and EL2470, it is possible to exceed the 150°C Absolute Maximum junction temperature under certain very high load current conditions. Generally speaking, when R_L falls below about 25Ω, it is important to calculate the maximum junction

temperature (T_{JMAX}) for the application to determine if power-supply voltages, load conditions, or package type need to be modified for the EL2170, EL2270, and EL2470 to remain in the safe operating area. These parameters are calculated as follows [1]:

$$T_{JMAX} = T_{MAX} + (\theta_{JA} \times n \times PD_{MAX})$$

where:

T_{MAX} = Maximum ambient temperature

θ_{JA} = Thermal resistance of the package

n = Number of amplifiers in the package

PD_{MAX} = Maximum power dissipation of each amplifier in the package

PD_{MAX} for each amplifier can be calculated as follows [2]:

$$PD_{MAX} = (2 \times V_S \times I_{SMAX}) + (V_S - V_{OUTMAX}) \times \frac{V_{OUTMAX}}{R_L}$$

where:

V_S = Supply voltage

I_{SMAX} = Maximum supply current of 1 amplifier

V_{OUTMAX} = Maximum output voltage of the application

R_L = Load resistance

Typical Application Circuits

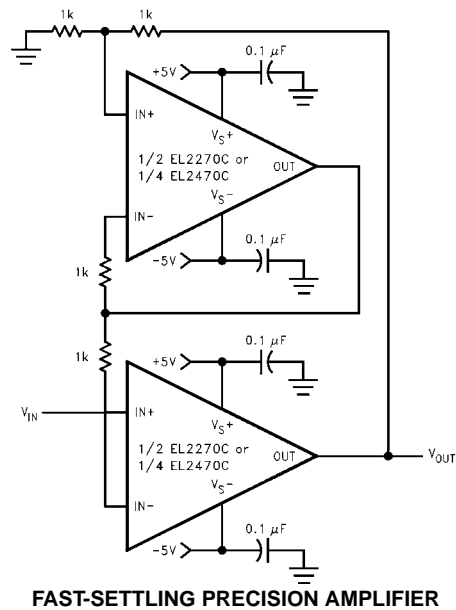
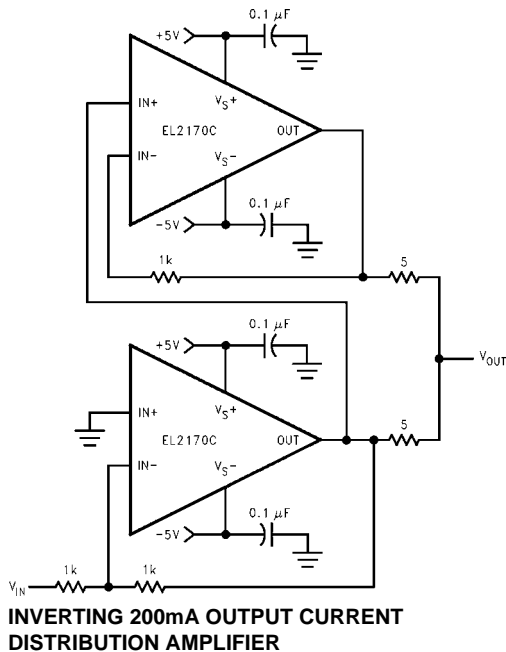

Typical Application Circuits (Continued)

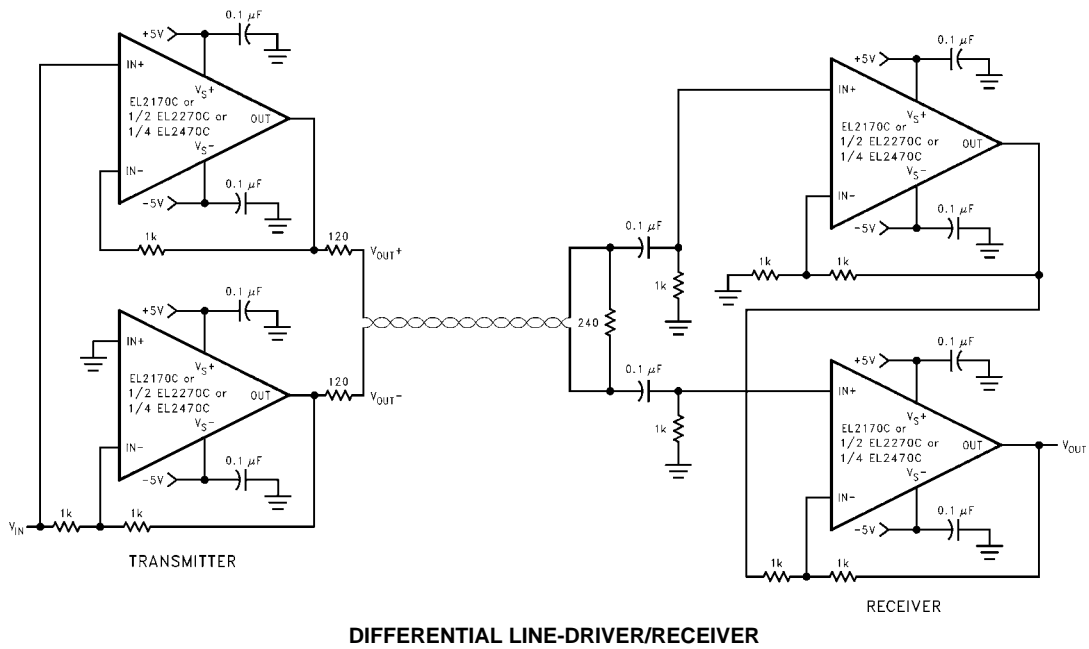

EL2170/EL2270/EL2470 Macromodel

* Revision A, March 1995

* AC characteristics used Rf=Rg=1KΩ,RL=150Ω

```
* Connections:      +input
*                   |
*                   | -input
*                   | |
*                   | | +Vsupply
*                   | | |
*                   | | | -Vsupply
*                   | | | |
*                   | | | | output
*                   | | | | |
.subckt EL2170/el 3 2 7 4 6
*
```

* Input Stage

```
*
e1 10 0 3 0 1.0
vis 10 9 0V
h2 9 12 vxx 1.0
r1 2 11 165
l1 11 12 25nH*
iinp 3 0 0.5uA
iinm 2 0 4uA*
r12 3 0 4Meg
*
```

* Slew Rate Limiting

```
*
h1 13 0 vis 600
r2 13 14 1K
d1 14 0 dclamp
d2 0 14 dclamp
*
```

* High Frequency Pole

```
*
e2 30 0 14 0 0.001666666666
l3 30 17 0.5uH
c5 17 0 0.69pF
r5 17 0 300
*
```

* Transimpedance Stage

```
*
g1 0 18 17 0 1.0
rol 18 0 400K
cdp 18 0 1.9pF
*
```

* Output Stage

```
*
q1 4 18 19 qp
q2 7 18 20 qn
q3 7 19 21 qn
q4 4 20 22 qp
r7 21 6 4
r8 22 6 4
ios1 7 19 0.4mA
ios2 20 4 0.4mA
* Supply Current
```

```
ips 7 4 1nA
*
```

* Error Terms

```
*
ivos 0 23 2mA
vxx 23 0 0V
e4 24 0 3 0 1.0
```

```
e5 25 0 7 0 1.0
e6 26 0 4 0 -1.0
r9 24 23 0.316K
r10 25 23 3.2K
r11 26 23 3.2K
*
* Models
*
.model qn npn(is=5e-15 bf=200 tf=0.01nS)
.model qp pnp(is=5e-15 bf=200 tf=0.01nS)
.model dclamp d(is=1e-30 ibv=0.266
+ bv=1.3v n=4)
.ends
```

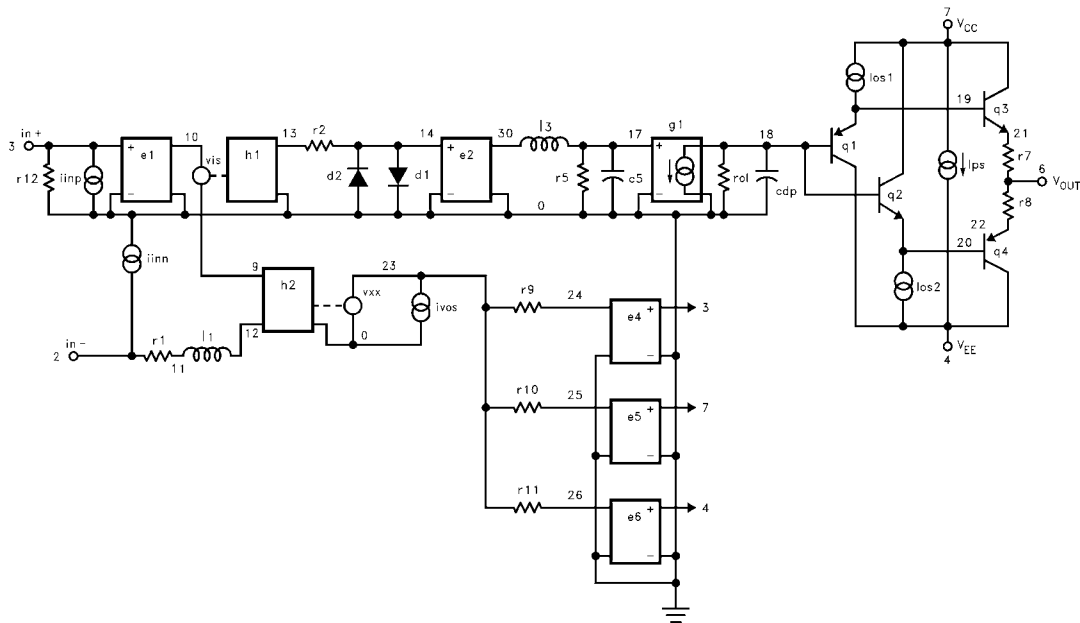

All Intersil U.S. products are manufactured, assembled and tested utilizing ISO9000 quality systems.
Intersil Corporation's quality certifications can be viewed at www.intersil.com/design/quality

Intersil products are sold by description only. Intersil Corporation reserves the right to make changes in circuit design, software and/or specifications at any time without notice. Accordingly, the reader is cautioned to verify that data sheets are current before placing orders. Information furnished by Intersil is believed to be accurate and reliable. However, no responsibility is assumed by Intersil or its subsidiaries for its use; nor for any infringements of patents or other rights of third parties which may result from its use. No license is granted by implication or otherwise under any patent or patent rights of Intersil or its subsidiaries.

For information regarding Intersil Corporation and its products, see www.intersil.com